

+12 to +32 dBm

# Limiter

## RLM-63-2W+

50Ω Broadband 30 to 6000 MHz

### Maximum Ratings

Operating Temperature	-40°C to 85°C
Storage Temperature	-55°C to 100°C
RF Input Power	2W

Permanent damage may occur if any of these limits are exceeded.

### Pin Connections

INPUT	1
OUTPUT	4
GROUND	2,3,5,6

### Outline Drawing

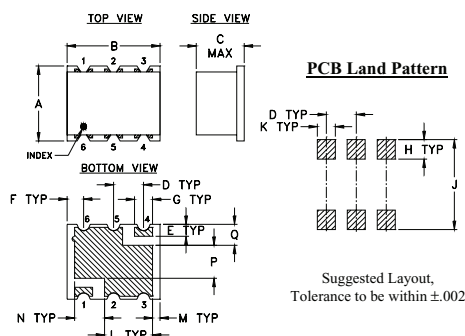

Suggested Layout, Tolerance to be within ±.002

### Outline Dimensions (inch/mm)

A	B	C	D	E	F	G	H
.25	.31	.16	.100	.040	.055	.060	.065
6.35	7.87	4.06	2.54	1.02	1.40	1.52	1.65
J	K	L	M	N	P	Q	wt.
.300	.060	.160	.025	.100	.110	.070	grams
7.62	1.52	4.06	0.64	2.54	2.79	1.78	0.16

### Demo Board MCL P/N: TB-393 Suggested PCB Layout (PL-258)

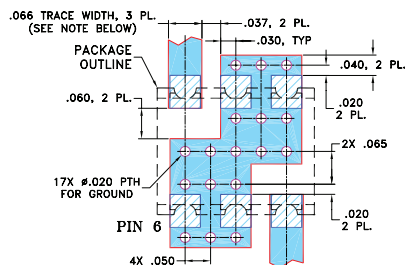

- NOTES: 1. TRACE WIDTH IS SHOWN FOR ROGERS RO4350B WITH DIELECTRIC THICKNESS .030" ± .002"; COPPER: 1/2 OZ. EACH SIDE. FOR OTHER MATERIALS TRACE WIDTH MAY NEED TO BE MODIFIED.  
 2. BOTTOM SIDE OF THE PCB IS CONTINUOUS GROUND PLANE.  
 DENOTES PCB COPPER LAYOUT WITH SMOBC (SOLDER MASK OVER BARE COPPER)  
 DENOTES COPPER LAND PATTERN FREE OF SOLDER MASK

#### Notes

- A. Performance and quality attributes and conditions not expressly stated in this specification document are intended to be excluded and do not form a part of this specification document.  
 B. Electrical specifications and performance data contained in this specification document are based on Mini-Circuit's applicable established test performance criteria and measurement instructions.  
 C. The parts covered by this specification document are subject to Mini-Circuits standard limited warranty and terms and conditions (collectively, "Standard Terms"); Purchasers of this part are entitled to the rights and benefits contained therein. For a full statement of the Standard Terms and the exclusive rights and remedies thereunder, please visit Mini-Circuits' website at [www.minicircuits.com/MCLStore/terms.jsp](http://www.minicircuits.com/MCLStore/terms.jsp)

### Features

- wideband, 30 to 6000 MHz
- low insertion loss 0.3 dB typ.
- fast recovery time, 10nsec typ.
- excellent VSWR 1.2:1 typ.
- low output power, 11.5 dBm typ.

### Applications

- military, hi-rel applications
- stabilizing generator outputs
- reducing amplitude variations
- protects low noise amplifiers and other devices from ESD or input power damage



Generic photo used for illustration purposes only

CASE STYLE: TT1224

### +RoHS Compliant

The +Suffix identifies RoHS Compliance. See our web site for RoHS Compliance methodologies and qualifications

### Electrical Specifications

Parameter	Condition	Min.	Typ.	Max.	Units
Frequency Range		30	—	6000	MHz
<b>Linear Range</b>					
Max Input Power	less than 0.1 dB compression	—	—	3	dBm
Insertion Loss	less than +3 dBm input power	—	0.3	1.3	dB
VSWR	less than +3 dBm input power	—	1.2	1.6	:1
<b>Limiting Range</b>					
Input Power	>1dB compression filtered signal frequency	+12	—	+32	dBm
Output Power		—	+11.5	—	dBm
Δ Output/ Δ 1dB Input	Input Power Range (dBm)				
	12 to 20	—	0.4	—	
	20 to 25	—	0.2	—	
	25 to 32	—	0.8	—	dB/dB
Recovery Time	1 watt pulse 50 μsec pw 1kHz duty cycle recovery to within 90% of final value.	—	10	—	nsec
Response Time	-30 to +30 dBm input 50 μsec PW 1 kHz duty cycle	—	2	—	nsec

### Typical Performance Data

Freq. (MHz)	I. Loss (dB) in Linear Range at +3 dBm	VSWR (:1) in Linear Range at +3 dBm	Power Output (dBm)				Δ Output / Δ 1dB Input		
			+12 dBm Input	+20 dBm Input	+25 dBm Input	+32dBm Input	+12 to +20 dBm Input	+20 to +25 dBm Input	+25 to +32 dBm Input
30.00	0.05	1.23	9.74	11.16	11.66	12.28	0.18	0.10	0.09
100.00	0.02	1.06	9.81	10.95	11.23	11.85	0.14	0.06	0.09
500.00	0.04	1.02	9.12	10.31	10.59	12.21	0.15	0.06	0.23
800.00	0.13	1.02	8.80	10.18	11.13	8.41	0.17	0.19	-0.39
1040.00	0.09	1.01	8.85	10.36	10.79	10.61	0.19	0.09	-0.03
1520.00	0.15	1.01	8.84	10.33	10.04	10.48	0.19	-0.06	0.06
2000.00	0.15	1.04	8.69	10.88	9.65	9.72	0.27	-0.25	0.01
2500.00	0.21	1.14	9.29	8.53	7.70	11.71	-0.10	-0.17	0.57
3000.00	0.24	1.20	9.62	6.28	7.18	12.47	-0.42	0.18	0.76
3500.00	0.26	1.14	9.63	4.90	6.72	12.89	-0.59	0.36	0.88
4000.00	0.30	1.01	9.98	3.71	6.21	13.45	-0.78	0.50	1.03
4500.00	0.36	1.14	10.12	3.78	5.29	13.47	-0.79	0.30	1.17
5000.00	0.43	1.24	10.12	3.73	6.38	11.01	-0.80	0.53	0.66
5500.00	0.63	1.29	9.83	4.03	7.54	11.16	-0.73	0.70	0.52
6000.00	0.69	1.37	9.27	3.53	7.38	12.63	-0.72	0.77	0.75



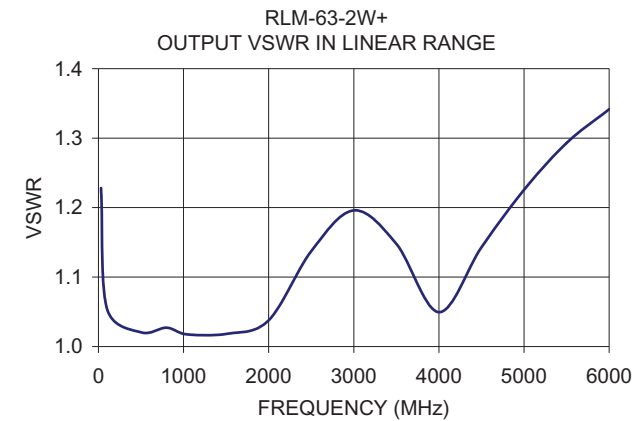
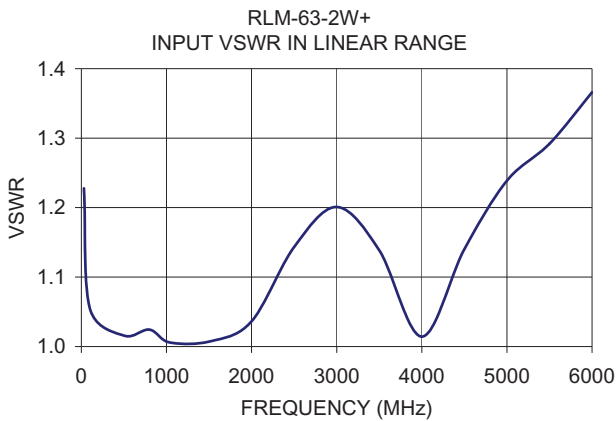
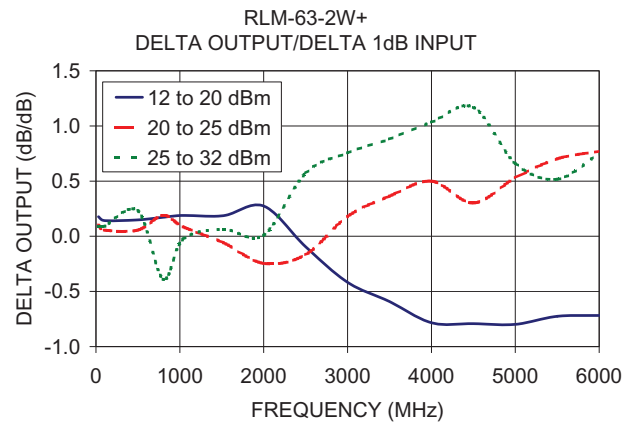
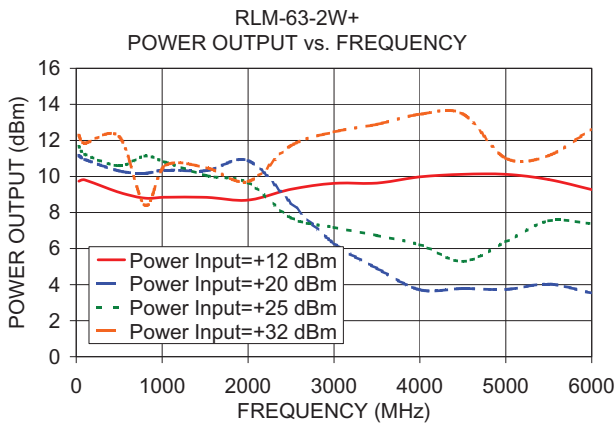
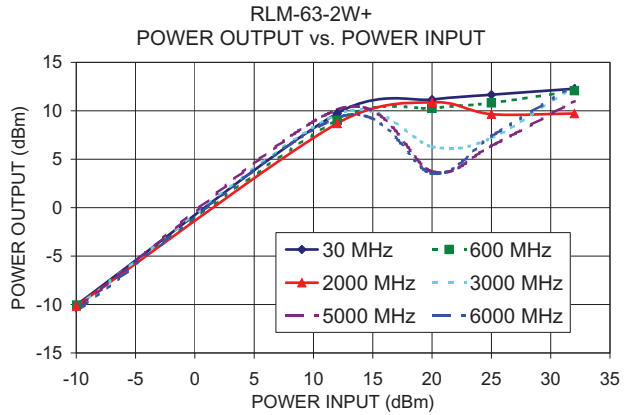
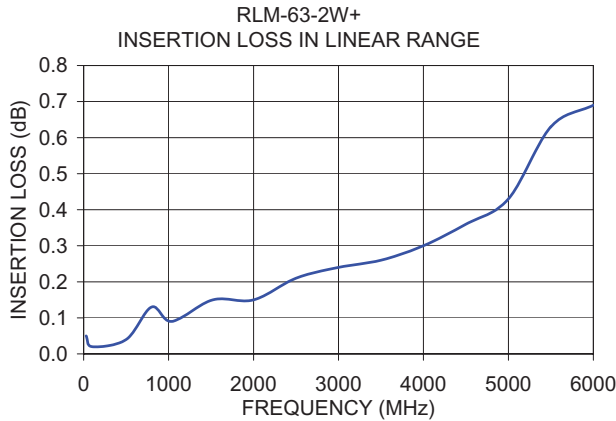

**Notes**

- A. Performance and quality attributes and conditions not expressly stated in this specification document are intended to be excluded and do not form a part of this specification document.
- B. Electrical specifications and performance data contained in this specification document are based on Mini-Circuit's applicable established test performance criteria and measurement instructions.
- C. The parts covered by this specification document are subject to Mini-Circuits standard limited warranty and terms and conditions (collectively, "Standard Terms"); Purchasers of this part are entitled to the rights and benefits contained therein. For a full statement of the Standard Terms and the exclusive rights and remedies thereunder, please visit Mini-Circuits' website at [www.minicircuits.com/MCLStore/terms.jsp](http://www.minicircuits.com/MCLStore/terms.jsp)



## Typical Performance Data

FREQUENCY (MHz)	LOW INPUT POWER			POWER OUTPUT (dBm)				DELTA OUTPUT/1dB DELTA INPUT (dB/dB)		
	INSERTION LOSS (dB)	VSWR		+12 dBm INPUT	+20 dBm INPUT	+25 dBm INPUT	+32 dBm INPUT	+12 to +20 dBm INPUT	+20 to +25 dBm INPUT	+25 to +32 dBm INPUT
		Input	Output							
		(:1)								
30.0	0.05	1.23	1.23	9.74	11.16	11.66	12.28	0.18	0.10	0.09
100.0	0.02	1.06	1.05	9.81	10.95	11.23	11.85	0.14	0.06	0.09
500.0	0.04	1.02	1.02	9.12	10.31	10.59	12.21	0.15	0.06	0.23
800.0	0.13	1.02	1.03	8.80	10.18	11.13	8.41	0.17	0.19	-0.39
1040.0	0.09	1.01	1.02	8.85	10.36	10.79	10.61	0.19	0.09	-0.03
1520.0	0.15	1.01	1.02	8.84	10.33	10.04	10.48	0.19	-0.06	0.06
2000.0	0.15	1.04	1.04	8.69	10.88	9.65	9.72	0.27	-0.25	0.01
2500.0	0.21	1.14	1.14	9.29	8.53	7.70	11.71	-0.10	-0.17	0.57
3000.0	0.24	1.20	1.20	9.62	6.28	7.18	12.47	-0.42	0.18	0.76
3500.0	0.26	1.14	1.15	9.63	4.90	6.72	12.89	-0.59	0.36	0.88
4000.0	0.30	1.01	1.05	9.98	3.71	6.21	13.45	-0.78	0.50	1.03
4500.0	0.36	1.14	1.14	10.12	3.78	5.29	13.47	-0.79	0.30	1.17
5000.0	0.43	1.24	1.23	10.12	3.73	6.38	11.01	-0.80	0.53	0.66
5500.0	0.63	1.29	1.29	9.83	4.03	7.54	11.16	-0.73	0.70	0.52
6000.0	0.69	1.37	1.34	9.27	3.53	7.38	12.63	-0.72	0.77	0.75

# Surface Mount Limiter

# RLM-63-2W+

## Typical Performance Data

POWER INPUT	POWER OUTPUT	POWER INPUT	POWER OUTPUT	POWER INPUT	POWER OUTPUT	POWER INPUT	POWER OUTPUT	POWER INPUT	POWER OUTPUT	POWER INPUT	POWER OUTPUT
@ 30 MHz		@ 600 MHz		@ 2000 MHz		@ 3000 MHz		@ 5000 MHz		@ 6000 MHz	
(dBm)		(dBm)		(dBm)		(dBm)		(dBm)		(dBm)	
-10	-10.05	-10	-10.06	-10	-10.15	-10	-10.24	-10	-10.43	-10	-10.69
12	9.74	12	9.03	12	8.69	12	9.62	12	10.12	12	9.27
20	11.16	20	10.27	20	10.88	20	6.28	20	3.73	20	3.53
25	11.66	25	10.82	25	9.65	25	7.18	25	6.38	25	7.38
32	12.28	32	12.08	32	9.72	32	12.47	32	11.01	32	12.63



P.O. Box 350166, Brooklyn, New York 11235-0003 (718) 934-4500 • Fax (718) 332-4661 For detailed performance specs & shopping online see Mini-Circuits web site  
 The Design Engineers Search Engine Provides ACTUAL Data Instantly From MINI-CIRCUITS At: [www.minicircuits.com](http://www.minicircuits.com)



The Design Engineers Search Engine Provides ACTUAL Data Instantly From MINI-CIRCUITS At: [www.minicircuits.com](http://www.minicircuits.com)

IF/RF MICROWAVE COMPONENTS

REV. X1  
 RLM-63-2W+  
 7/11/2011  
 Page 2 of 2

## Typical Performance Curves

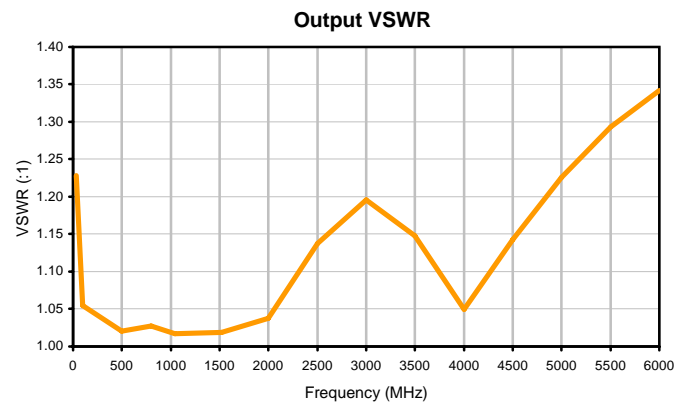
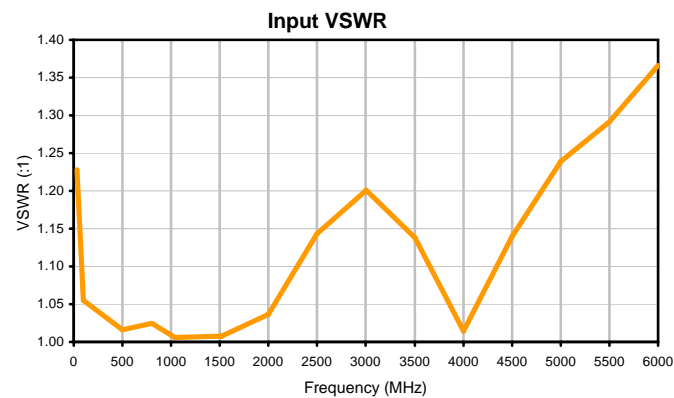
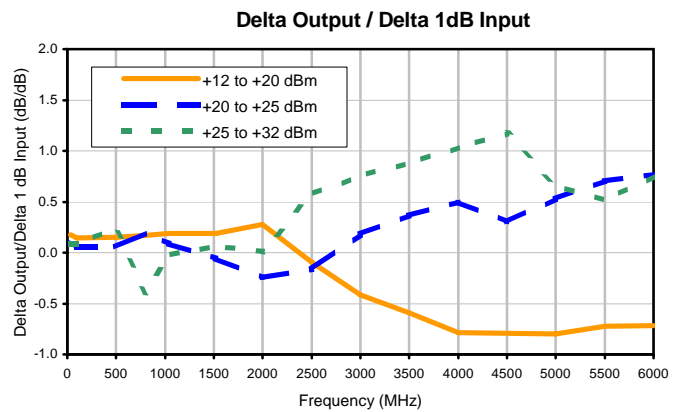
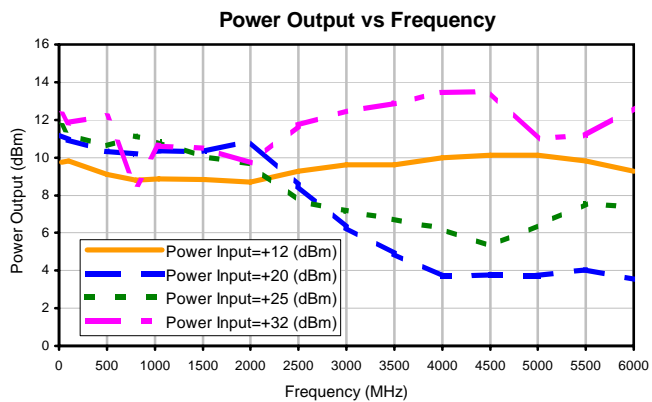
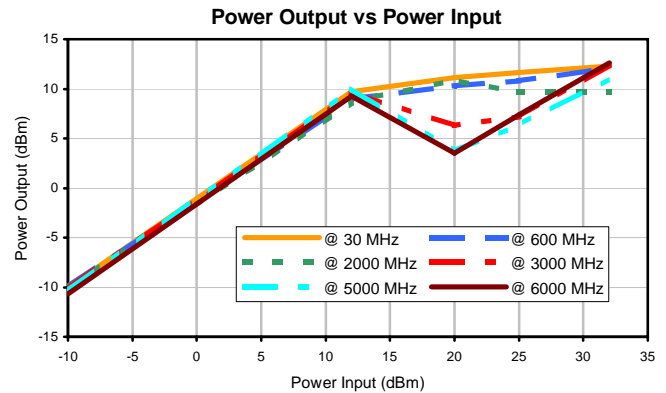
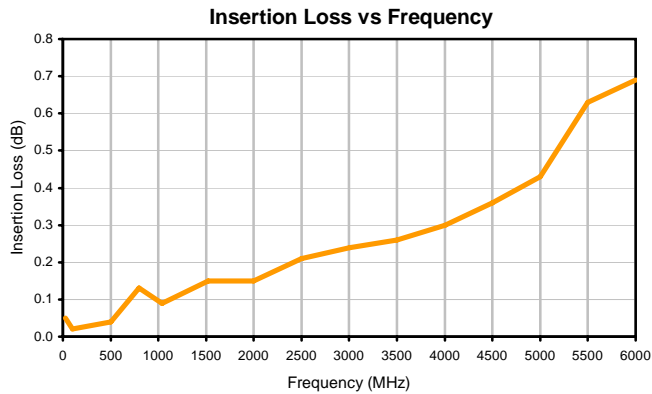

### Outline Dimensions

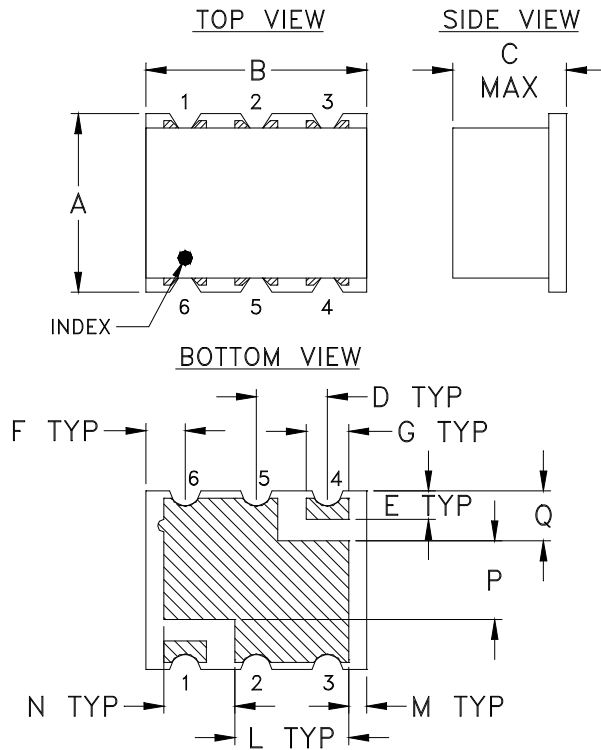

### PCB Land Pattern

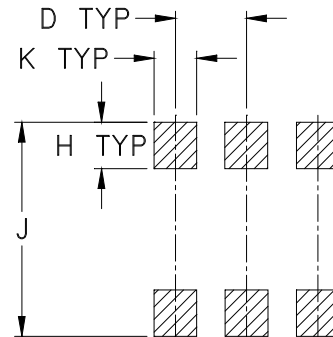

Suggested Layout,  
Tolerance to be within  $\pm .002$

CASE #	A	B	C	D	E	F	G	H	J	K	L
TT1224	.25 (6.35)	.31 (7.87)	.16 (4.06)	.100 (2.54)	.040 (1.02)	.055 (1.40)	.060 (1.52)	.065 (1.65)	.300 (7.62)	.060 (1.52)	.160 (4.06)

CASE #	M	N	P	Q	WT. GRAM
TT1224	.025 (.64)	.100 (2.54)	.110 (2.79)	.070 (1.78)	.16

Dimensions are in inches (mm). Tolerances: 2Pl.  $\pm .01$ ; 3 Pl.  $\pm .005$

### Notes:

1. Case material: Plastic.
2. Termination: 2-10  $\mu$  inch (.05-.25 microns) Gold over 100-300  $\mu$  inch (2.54-7.62 microns) Nickel plate



P.O. Box 350166, Brooklyn, New York 11235-0003 (718) 934-4500 Fax (718) 332-4661 For detailed performance specs & shopping online see Mini-Circuits web site



The Design Engineers Search Engine Provides ACTUAL Data Instantly From MINI-CIRCUITS At: [www.minicircuits.com](http://www.minicircuits.com)

RF/IF MICROWAVE COMPONENTS

# Tape & Reel Packaging TR-F2

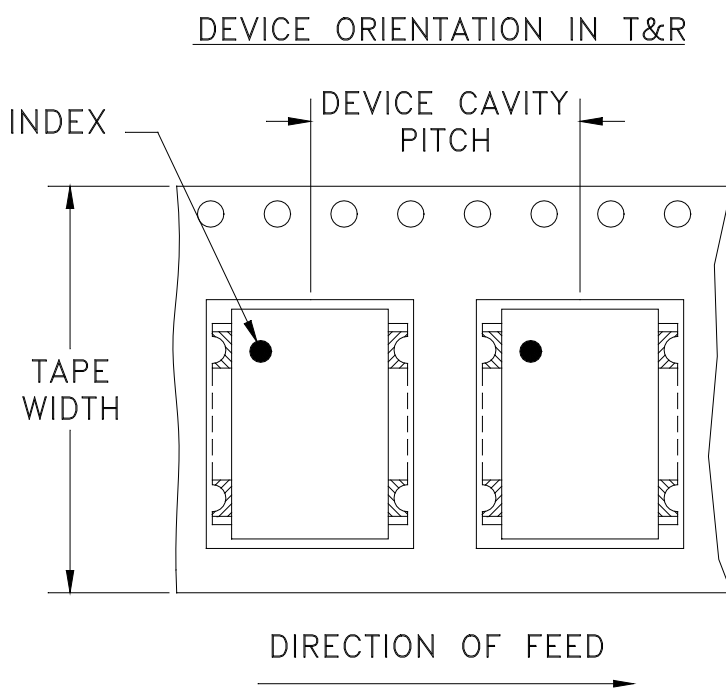

Tape Width, mm	Device Cavity Pitch, mm	Reel Size, inches	Devices per Reel See note
16	12	7	10
			20
			50
			100
			200
		13	500
			1000

Mini-Circuits carrier tape materials provide protection from ESD (Electro-Static Discharge) during handling and transportation. Tapes are static dissipative and comply with industry standards EIA-481/EIA-541.

Go to: [www.minicircuits.com/pages/pdfs/tape.pdf](http://www.minicircuits.com/pages/pdfs/tape.pdf)



INTERNET <http://www.minicircuits.com>

P.O. Box 350166, Brooklyn, New York 11235-0003 (718) 934-4500 Fax (718) 332-4661

Distribution Centers NORTH AMERICA 800-654-7949 • 417-335-5935 • Fax 417-335-5945 • EUROPE 44-1252-832600 • Fax 44-1252-837010

Mini-Circuits ISO 9001 & ISO 14001 Certified

THIRD ANGLE PROJECTION

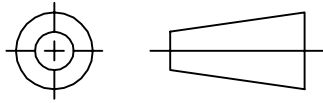

REVISIONS

REV	ECN No.	DESCRIPTION	DATE	DR	AUTH
OR	M108897	NEW RELEASE	01/04/07	AV	DJ

SUGGESTED MOUNTING CONFIGURATION  
FOR TT1224 CASE STYLE "rv" PIN CONNECTION

.066 TRACE WIDTH, 3 PL.  
(SEE NOTE BELOW)

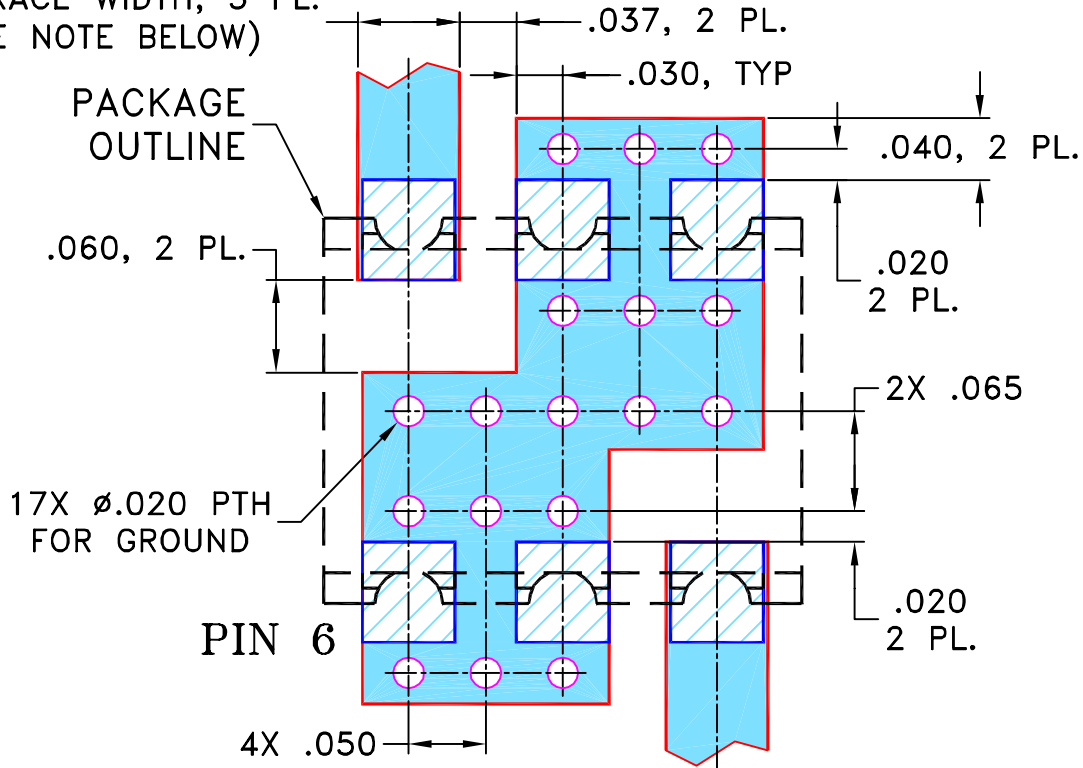

- NOTES: 1. TRACE WIDTH IS SHOWN FOR ROGERS R04350B WITH DIELECTRIC THICKNESS .030" ± .002"; COPPER: 1/2 OZ. EACH SIDE. FOR OTHER MATERIALS TRACE WIDTH MAY NEED TO BE MODIFIED.  
2. BOTTOM SIDE OF THE PCB IS CONTINUOUS GROUND PLANE.



DENOTES PCB COPPER LAYOUT WITH SMOBC  
(SOLDER MASK OVER BARE COPPER)



DENOTES COPPER LAND PATTERN FREE OF SOLDER MASK

UNLESS OTHERWISE SPECIFIED

INITIALS

DATE

DIMENSIONS ARE IN INCHES

DRAWN

AV

12/14/06

TOLERANCES ON:

CHECKED

IL

01/04/07

2 PL DECIMALS ± .005

APPROVED

DJ

01/04/07

ANGLES ±

FRACTIONS ±

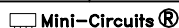

THIS DOCUMENT AND ITS CONTENTS ARE THE PROPERTY OF MINI-CIRCUITS. EXCEPT FOR USE EXPRESSLY GRANTED, IN WRITING, TO ITS VENDORS, VENDEE AND THE UNITED STATES GOVERNMENT, MINI-CIRCUITS RESERVES ALL PROPRIETARY DESIGN, USE, MANUFACTURING AND REPRODUCTION RIGHTS THERETO. THESE CONTENTS SHALL NOT BE USED, DUPLICATED OR DISCLOSED TO ANY OUTSIDE PARTY, IN WHOLE OR IN PART, WITHOUT WRITTEN PERMISSION OF MINI-CIRCUITS.

ASHEETA1.DWG REV:A DATE:01/12/95



Mini-Circuits®

13 Neptune Avenue  
Brooklyn NY 11235

PL, rv, TT1224, RMK-3-662+, TB-393

SIZE  
A

CODE IDENT  
15542

DRAWING NO:  
98-PL-258

REV:  
OR

FILE: 98PL258

SCALE: 8:1

SHEET: 1 OF 1



# Evaluation Board and Circuit

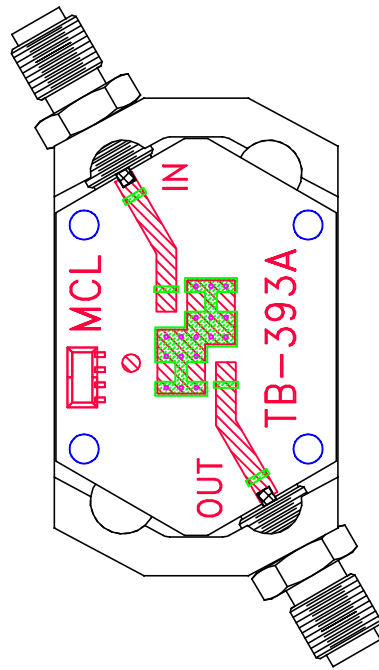

TB-393

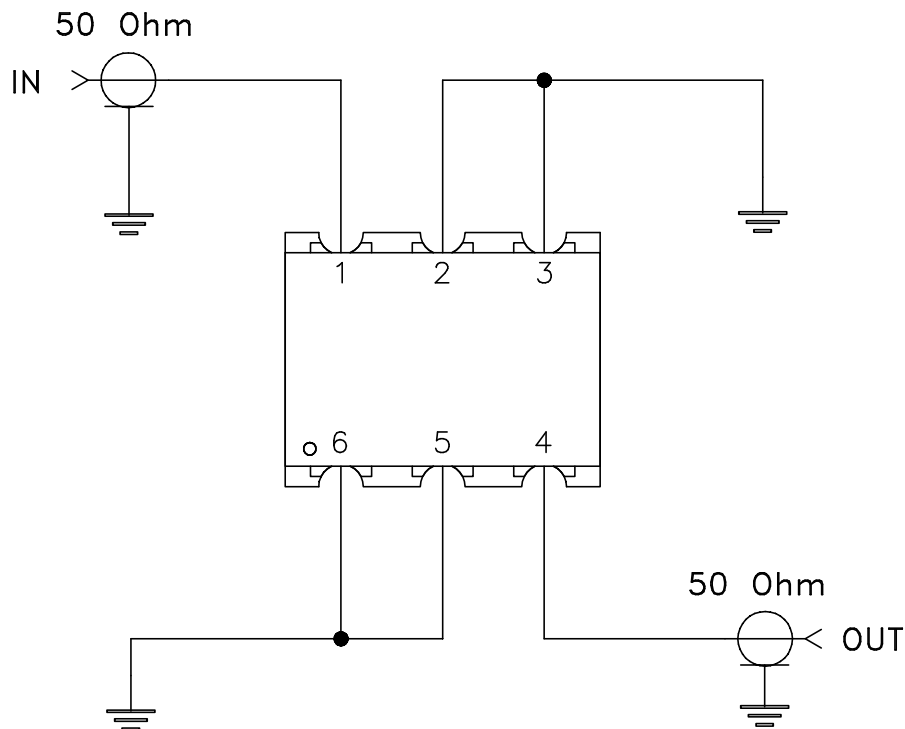

Schematic Diagram

## Notes:

1. SMA Female connectors.
2. PCB Material: Rogers R04350 or equivalent, Dielectric Constant=3.5, Thickness=.030 inch.

 Mini-Circuits®

All Mini-Circuits products are manufactured under exacting quality assurance and control standards, and are capable of meeting published specifications after being subjected to any or all of the following physical and environmental test.

Specification	Test/Inspection Condition	Reference/Spec
Operating Temperature	-40° to 85°C Ambient Environment	Individual Model Data Sheet
Storage Temperature	-55° to 100° C Ambient Environment	Individual Model Data Sheet
Humidity	90 to 95% RH, 240 hours, 50°C	MIL-STD-202, Method 103, Condition A, Except 50°C and end-point electrical test done within 12 hours
Thermal Shock	-55° to 100°C, 100 cycles	MIL-STD-202, Method 107, Condition A-3, except +100°C
Solder Reflow Heat	Sn-Pb Eutetic Process: 225°C peak Pb-Free Process 245° - 250°C peak	J-STD-020, Table 4-1, 4-2 and 5-2, Figure 5-1
Solderability	10X Magnification	J-STD-002, 95% Coverage
Vibration (High Frequency)	20g peak, 10-2000 Hz, 12 times in each of three perpendicular directions (total 36)	MIL-STD-202, Method 204, Condition D
Mechanical Shock	50g, 11 ms, 1/2-sine, 18 shocks: 3 each direction, each of 3 axes	MIL-STD-202, Method 213, Condition A
Marking Resistance to Solvents	Isopropyl alcohol + mineral spirits at 25°C; terpene defluxer at 25°C; distilled water + proylene glycol monomethyl ether + monoethanolamine at 63°C to 70°C	MIL-STD-202, Method 215