





# High Isolation Gate Drive Transformers



-  Rugged design for Industrial Applications
-  UL recognized, TUV approved to IEC 60950
-  Up to 4250Vrms gate to drive isolation
-  IEC 61558, IEC 61010 & IEC 60601 reinforced insulation compliant designs

Electrical Specifications @ 25°C - Operating Temperature -40°C to +125°C

Part Number <sup>4,5</sup>	Turns Ratio	ET (V * μsec MAX)	Primary Inductance (1-10) (μH MIN)	Leakage Inductance Gate to Drive (μH MAX)	DCR Drive (1-10) (mΩ ±20%)	DCR Gates (mΩ ±20%)	Hi-Pot	
							Drive-Gate (Vrms)	Gate-Gate (Vrms)
P0584NL	1:1:1	95	450	0.5	80	72	3000	1500
P0585NL	1:1:1:1	95	450	3.0	330	180	3000	1500*
P0584ANL	1:1:1	115	686	0.8	710	710	4250	1500
P0585ANL	1:1:1:1	115	686	4.6	710	710	4250	1500*

- Notes:**
1. These gate drive transformers are meant to operate between 50 and 300 kHz with a 12V, 45% bipolar waveform.
  2. The peak flux density should remain below 2100 Gauss to ensure that the core does not saturate. Use the following procedure to calculate the peak flux density:
    - A. Calculate the Volt-μsec product (ET):  
 $ET = 10 * (\text{Drive Voltage}) * (\text{Don}) / (\text{Frequency in kHz})$
    - B. Calculate the operating flux density (B):  $B_{PK} (\text{Gauss}) = X * ET / Ff$  where:  
 Ff = 1 for unipolar drive applications and 2 for bipolar drive applications,  
 X = 40 for -NL, 33 for -ANL
  3. The temperature rise of the component is calculated based on the total core loss and copper loss:
    - A. To calculate total copper loss (W), use the following formula:  
 $\text{Copper Loss (W)} = I_{rms}^2 * (\text{DCR\_Drive} + (\# \text{ of Gates}) * \text{DCR\_Gates})$
    - B. To calculate total core loss (W), use the following formula:  
 $\text{Copper Loss (W)} = 7.5E-5 * (\text{Frequency in kHz})^{1.67} * (X * ET/1000)^{2.532}$   
 X = 20 for -NL, 16 for -ANL
    - C. To calculate temperature rise, use the following formula:  
 $\text{Temperature Rise (C)} = 60.18 * (\text{Core Loss(W)} + \text{Copper Loss (W)})^{.833}$
  4. 500Vrms Hi-Pot between pins 5 & 6
  5. NL versions, which use triple insulated Teflon wire on the drive winding and magnetic wire on the gate windings, are TUV certified.  
 ANL versions, which use triple insulated wire on both the drive and gate windings, are compliant with IEC 61558, IEC 61010 & IEC 60601.

# High Isolation Gate Drive Transformers

## Mechanicals

## Schematics

P058xxNL

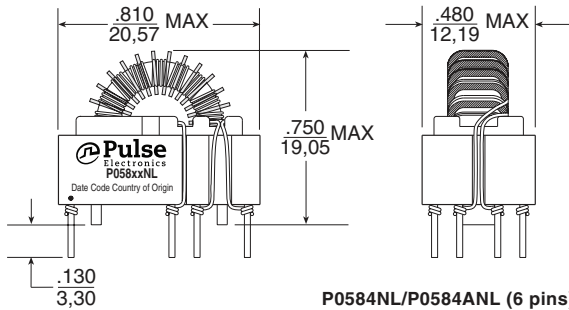

P0584NL/P0584ANL

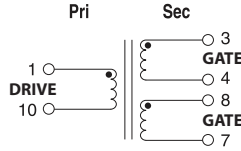

P0585NL/P0585ANL

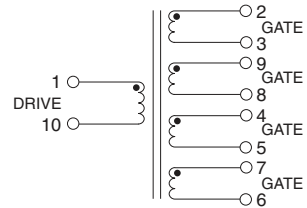

P0584NL/P0584ANL (6 pins)

P0585NL/P0585ANL (10 pins)

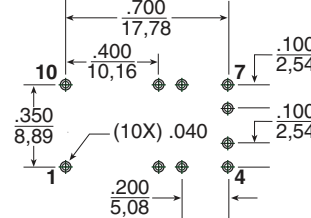
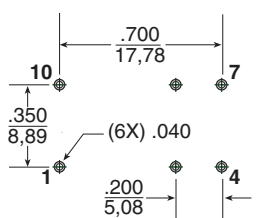
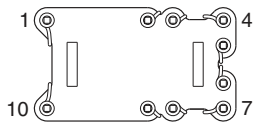

SUGGESTED PCB HOLE PATTERN

Weight .....5 grams  
Tray .....80/tray

Dimension:  $\frac{\text{Inches}}{\text{mm}}$   
Unless otherwise specified, all tolerances are  $\pm \frac{.010}{0,25}$

## For More Information

**Pulse Worldwide Headquarters**  
12220 World Trade Drive  
San Diego, CA  
92128  
U.S.A.

**Pulse Europe**  
Einsteinstrasse 1  
D-71083 Herrenberg  
Germany

**Pulse China Headquarters**  
B402, Shenzhen Academy of  
Aerospace Technology Bldg.  
10th Kejian Road  
High-Tech Zone  
Nanshan District  
Shenzhen, PR China  
518057  
Tel: 86 755 33966678  
Fax: 86 755 33966700

**Pulse North China**  
Room 2704/2705  
Super Ocean Finance  
Ctr.  
2067 Yan An Road  
West  
Shanghai 200336  
China  
Tel: 86 21 62787060  
Fax: 86 2162786973

**Pulse South Asia**  
135 Joo Seng Road  
#03-02  
PM Industrial Bldg.  
Singapore 368363  
Tel: 65 6287 8998  
Fax: 65 6287 8998

**Pulse North Asia**  
3F, No. 198  
Zhongyuan Road  
Zhongli City  
Taoyuan County 320  
Taiwan R. O. C.  
Tel: 886 3 4356768  
Fax: 886 3 4356823 (Pulse)  
Fax: 886 3 4356820 (FRE)

Tel: 858 674 8100  
Fax: 858 674 8262

Tel: 49 7032 78060  
Fax: 49 7032 7806 135

Performance warranty of products offered on this data sheet is limited to the parameters specified. Data is subject to change without notice. Other brand and product names mentioned herein may be trademarks or registered trademarks of their respective owners. © Copyright, 2015. Pulse Electronics, Inc. All rights reserved.