

YASMEEN-35-S

~15° spot beam

SPECIFICATION:

Dimensions	Ø 35.0 mm
Height	18 mm
Fastening	socket
ROHS compliant	yes ⓘ

MATERIALS:

Component	Type	Material	Colour	Finish	Length (mm)
YASMEEN-35-S	Single lens	PMMA	clear	gloss	
YASMEEN-35-HLD-B	Holder B	PC	black		
YASMEEN-35-HLD-B-WHT	Holder B	PC	white		



ORDERING INFORMATION:

Component	Qty in box	MOQ	MPQ	Box weight (kg)
C18518_YASMEEN-35-S	840	120	60	7.9
Assembly				
CP19220_YASMEEN-35-S-B-WHT	780	120	60	9.1
CP18523_YASMEEN-35-S-B	780	120	60	9.2

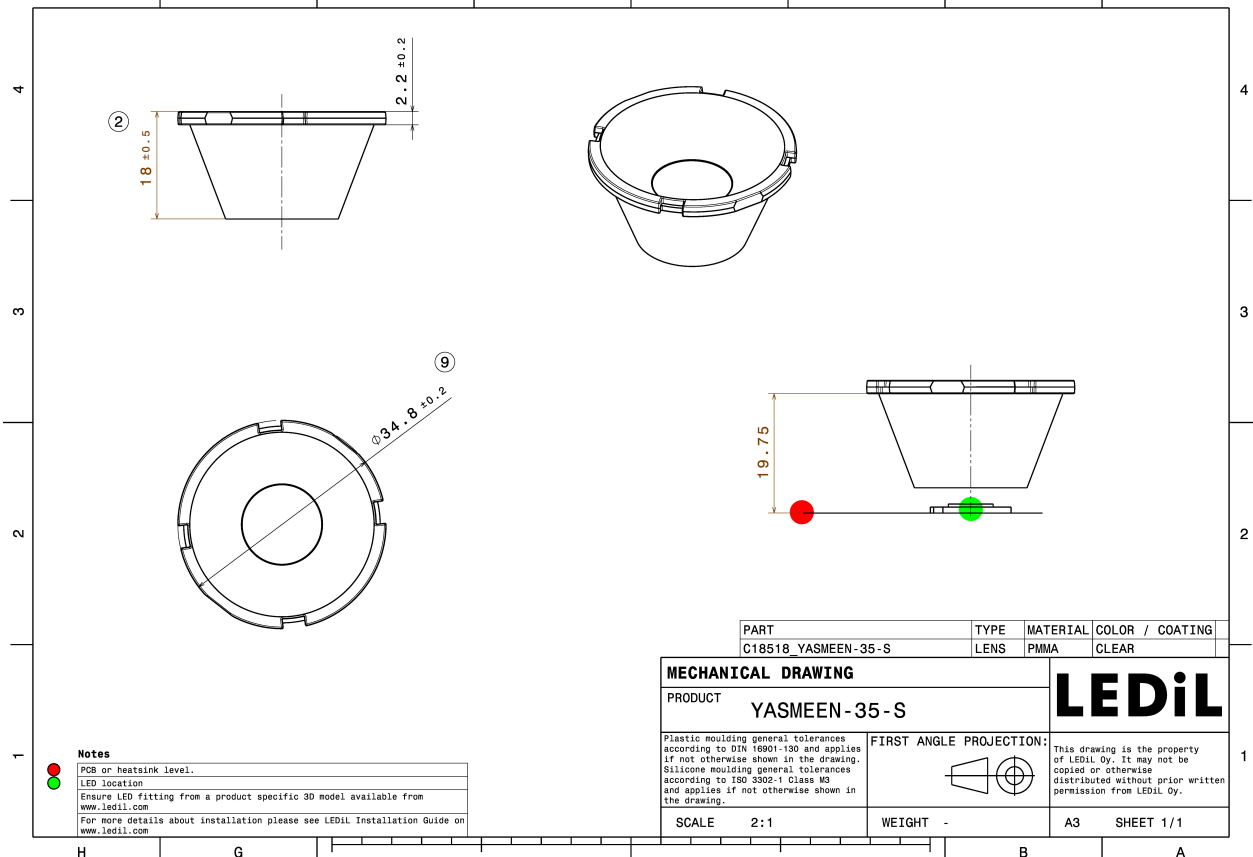
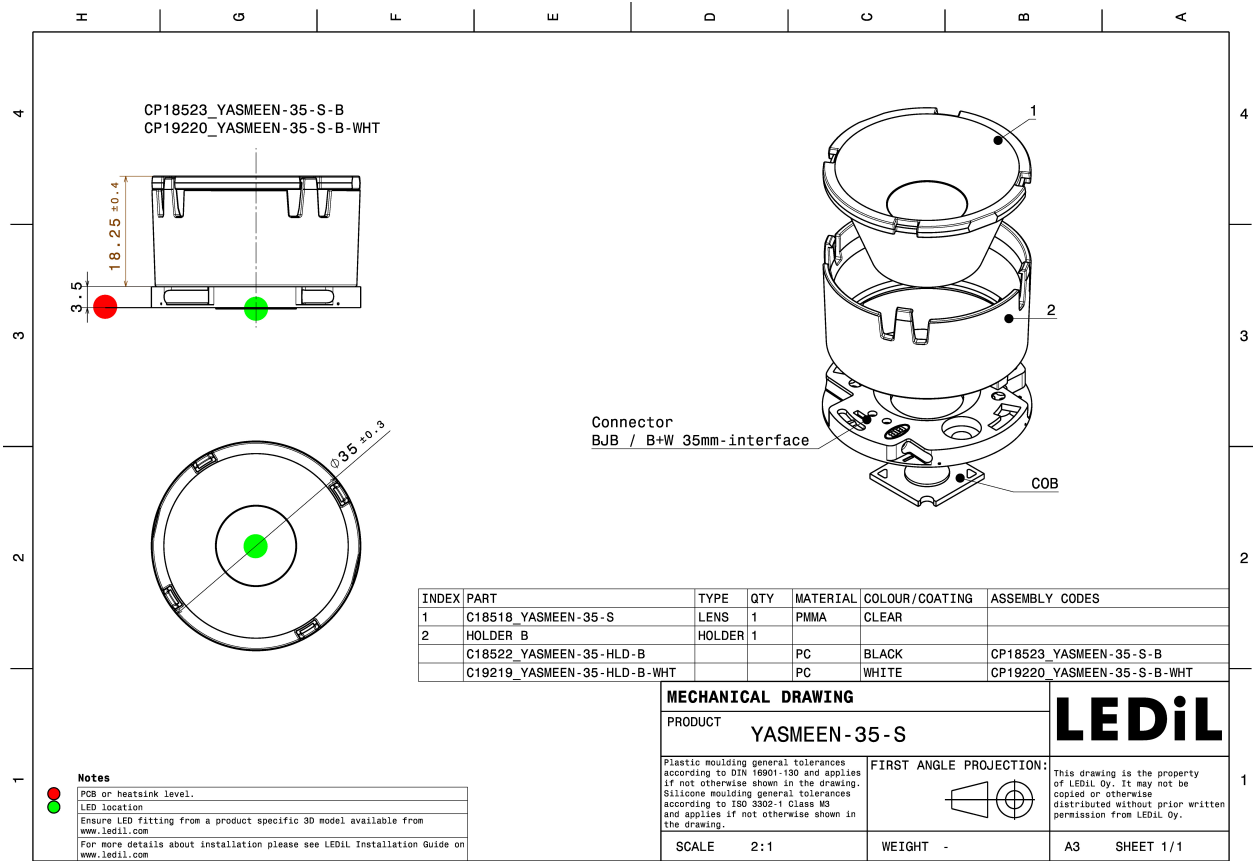

See also our general installation guide: www.ledil.com/installation_guide

OPTICAL RESULTS (MEASURED):

CITIZEN

LED CLU7L3
Ordering code CP18523_YASMEEN-35-S-B
FWHM / FWTM 10.0° / 19.0°
Efficiency 91 %
Peak intensity 20.3 cd/lm
LEDs/each optic 1
Light colour/type White
Required components:
C19425_SOCKET-B-35-N

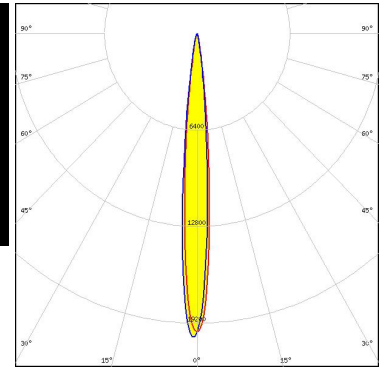

Light distribution files

CITIZEN

LED CLU7R3
Ordering code CP18523_YASMEEN-35-S-B
FWHM / FWTM 15.0° / 27.0°
Efficiency 92 %
Peak intensity 10.6 cd/lm
LEDs/each optic 1
Light colour/type White
Required components:
C19424_SOCKET-B-35-M

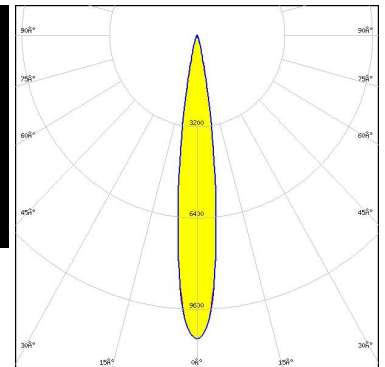
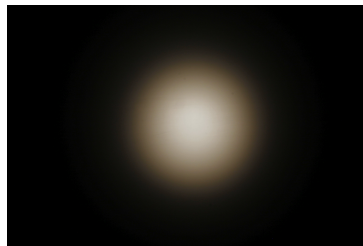

Light distribution files

CITIZEN

LED CLU7S3
Ordering code CP18523_YASMEEN-35-S-B
FWHM / FWTM 12.0° / 24.0°
Efficiency 92 %
Peak intensity 13.7 cd/lm
LEDs/each optic 1
Light colour/type White
Required components:
C19425_SOCKET-B-35-N

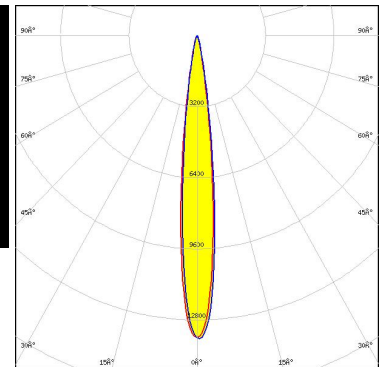

Light distribution files

OPTICAL RESULTS (MEASURED):

SAMSUNG

LED LC010C G2
Ordering code CP18523_YASMEEN-35-S-B
FWHM / FWTM 19.0° / 38.0°
Efficiency 88 %
Peak intensity 5.8 cd/lm
LEDs/each optic 1
Light colour/type White
Required components:
BJB: 47.360.1020

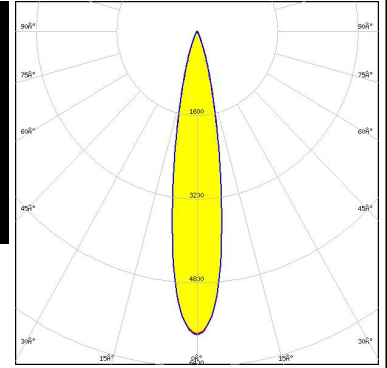
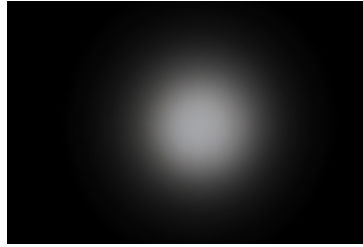

Light distribution files

OPTICAL RESULTS (SIMULATED):



LED V10 Gen 8-9
Ordering code CP18523_YASMEEN-35-S-B
FWHM / FWTM 28.0° / 53.0°
Efficiency 88 %
Peak intensity 3.1 cd/lm
LEDs/each optic 1
Light colour/type White
Required components:

Bender Wirth: 634b Bayonet35L

Light distribution files

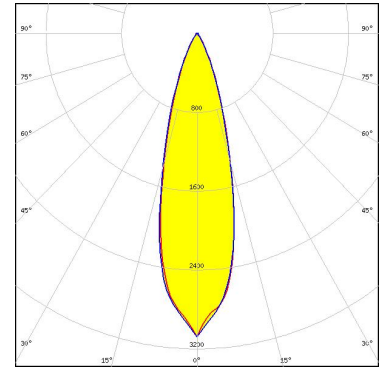

LED V6 HD Gen 7
Ordering code CP18523_YASMEEN-35-S-B
FWHM / FWTM 20.0° / 36.0°
Efficiency 89 %
Peak intensity 6.3 cd/lm
LEDs/each optic 1
Light colour/type White
Required components:

BJB: 47.360.1020

Light distribution files

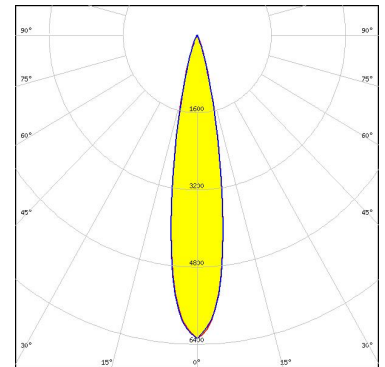

LED V6 HD Gen 8
Ordering code CP18523_YASMEEN-35-S-B
FWHM / FWTM 21.0° / 37.0°
Efficiency 91 %
Peak intensity 6 cd/lm
LEDs/each optic 1
Light colour/type White
Required components:

Bender Wirth: 634c Bayonet35L

Light distribution files

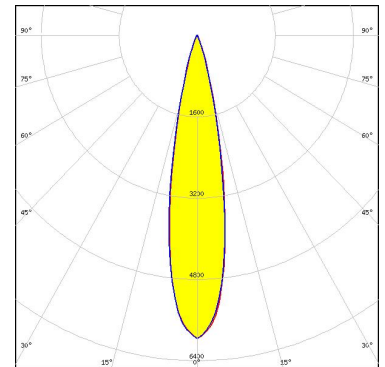

OPTICAL RESULTS (SIMULATED):



LED Vesta DTW 9mm (4W/6W/12W)
Ordering code CP18523_YASMEEN-35-S-B
FWHM / FWTM 28.0° / 49.0°
Efficiency 90 %
Peak intensity 3.3 cd/lm
LEDs/each optic 1
Light colour/type White
Required components:

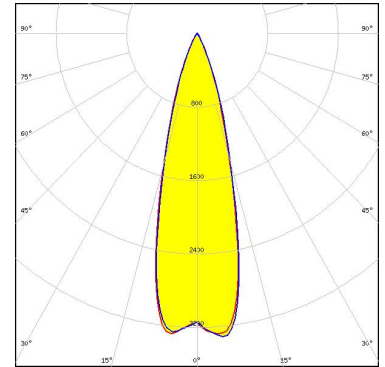

Bender Wirth: 652b Bayonet35L

Light distribution files

CITIZEN

LED CLL02x/CLU02x (LES10)
Ordering code CP18523_YASMEEN-35-S-B
FWHM / FWTM 28.0° / 53.0°
Efficiency 84 %
Peak intensity 2.9 cd/lm
LEDs/each optic 1
Light colour/type White
Required components:

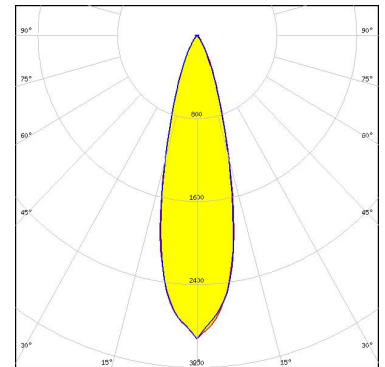

BJB: 47.360.1020

Light distribution files

CITIZEN

LED CLU700/701/702/703
Ordering code CP18253_YASMEEN-70-RS-C
FWHM / FWTM 20.0° / 36.0°
Efficiency 87 %
Peak intensity 5.9 cd/lm
LEDs/each optic 1
Light colour/type White
Required components:

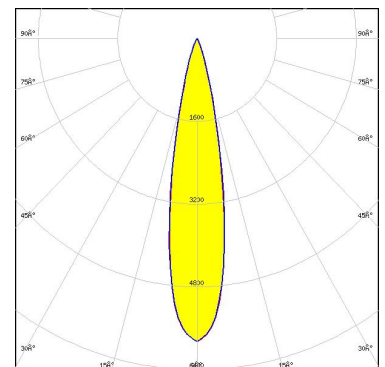

BJB: 47.360.1020

Light distribution files

OPTICAL RESULTS (SIMULATED):

CITIZEN

LED CLU7A2/7A3
Ordering code CP18523_YASMEEN-35-S-B
FWHM / FWTM 14.0° / 28.0°
Efficiency 88 %
Peak intensity 10.5 cd/lm
LEDs/each optic 1
Light colour/type White
Required components:

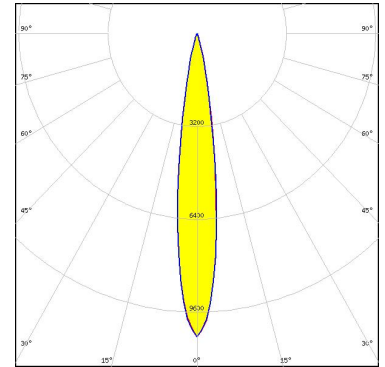

BJB: 47.360.1020

Light distribution files

CITIZEN

LED CLU7L3
Ordering code CP18523_YASMEEN-35-S-B
FWHM / FWTM 10.0° / 20.0°
Efficiency 88 %
Peak intensity 18.9 cd/lm
LEDs/each optic 1
Light colour/type White
Required components:
C19425_SOCKET-B-35-N

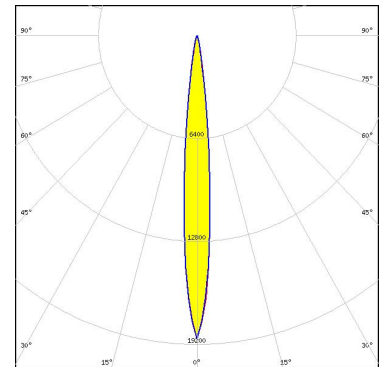

Light distribution files

CITIZEN

LED CLU7S3
Ordering code CP18523_YASMEEN-35-S-B
FWHM / FWTM 14.0° / 25.0°
Efficiency 88 %
Peak intensity 12.7 cd/lm
LEDs/each optic 1
Light colour/type White
Required components:
C19425_SOCKET-B-35-N

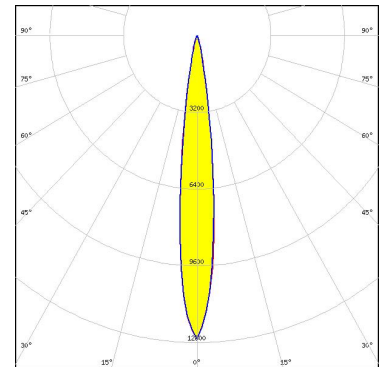

Light distribution files

OPTICAL RESULTS (SIMULATED):



LED: CHA0304
Ordering code: CP18523_YASMEEN-35-S-B
FWHM / FWTM: 12.0° / 23.0°
Efficiency: 88 %
Peak intensity: 15.6 cd/lm
LEDs/each optic: 1
Light colour/type: White
Required components:

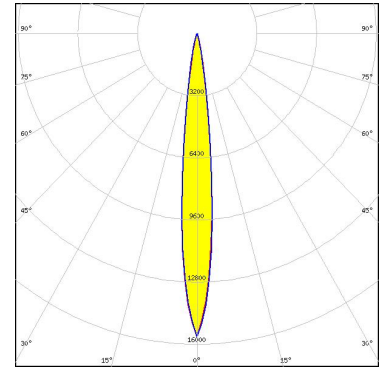

BJB: 47.360.1020

Light distribution files



LED: CHA0410
Ordering code: CP18523_YASMEEN-35-S-B
FWHM / FWTM: 16.0° / 28.0°
Efficiency: 88 %
Peak intensity: 10.3 cd/lm
LEDs/each optic: 1
Light colour/type: White
Required components:

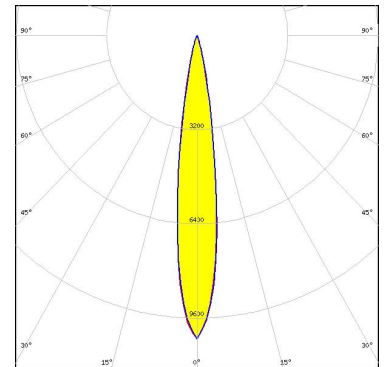

BJB: 47.360.1020

Light distribution files



LED: CHA0612
Ordering code: CP18523_YASMEEN-35-S-B
FWHM / FWTM: 20.0° / 36.0°
Efficiency: 88 %
Peak intensity: 6.3 cd/lm
LEDs/each optic: 1
Light colour/type: White
Required components:

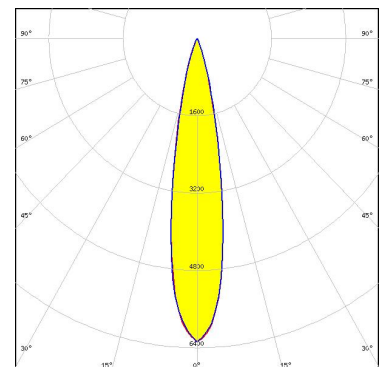

BJB: 47.360.1020

Light distribution files

OPTICAL RESULTS (SIMULATED):



LED XD16
Ordering code C18518_YASMEEN-35-S
FWHM / FWTM 8.0° / 20.0°
Efficiency 94 %
Peak intensity 19.1 cd/lm
LEDs/each optic 1
Light colour/type White
Required components:

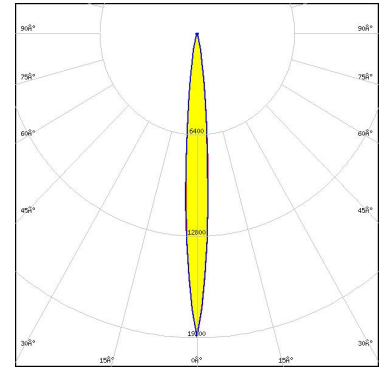

Light distribution files



LED XP-G3
Ordering code C18518_YASMEEN-35-S
FWHM / FWTM 10.0° / 20.0°
Efficiency 94 %
Peak intensity 19.1 cd/lm
LEDs/each optic 1
Light colour/type White
Required components:

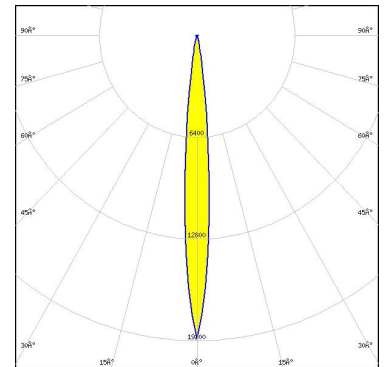

Light distribution files



LED LUXEON 7070
Ordering code C18518_YASMEEN-35-S
FWHM / FWTM 18.0° / 38.0°
Efficiency 94 %
Peak intensity 5.7 cd/lm
LEDs/each optic 1
Light colour/type White
Required components:

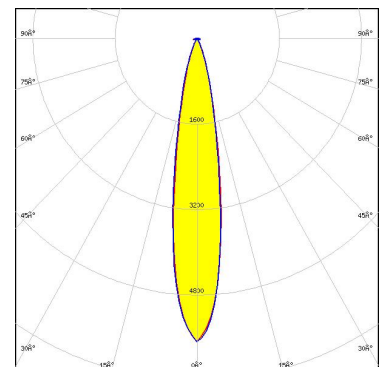

Light distribution files

OPTICAL RESULTS (SIMULATED):



LED LUXEON CX Plus CoB - HD S01H4
Ordering code CP18523_YASMEEN-35-S-B
FWHM / FWTM 16.0° / 30.0°
Efficiency 91 %
Peak intensity 8.8 cd/lm
LEDs/each optic 1
Light colour/type White
Required components:

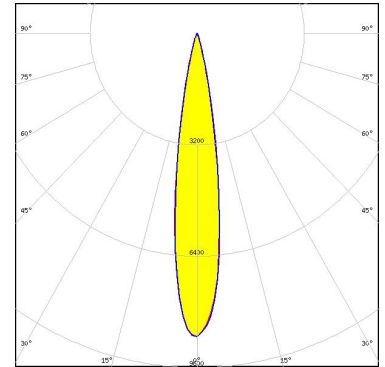

Bender Wirth: 634c Bayonet35L

Light distribution files



LED LUXEON CX Plus CoB - HD S02H6
Ordering code CP18523_YASMEEN-35-S-B
FWHM / FWTM 22.0° / 38.0°
Efficiency 91 %
Peak intensity 5.5 cd/lm
LEDs/each optic 1
Light colour/type White
Required components:

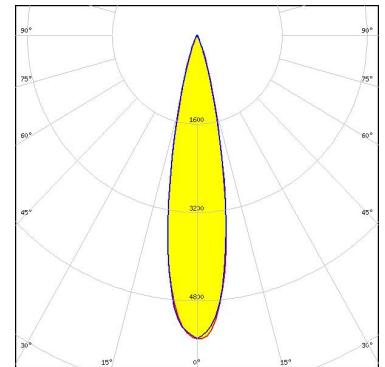

Bender Wirth: 634c Bayonet35L

Light distribution files



LED LUXEON CX Plus CoB - HD S04H9
Ordering code CP18523_YASMEEN-35-S-B
FWHM / FWTM 30.0° / 54.0°
Efficiency 89 %
Peak intensity 2.9 cd/lm
LEDs/each optic 1
Light colour/type White
Required components:

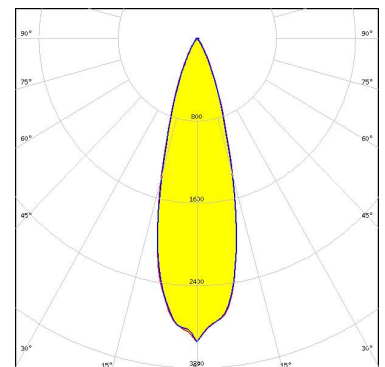

Bender Wirth: 634a Bayonet35L

Light distribution files

OPTICAL RESULTS (SIMULATED):

LUMILEDS

LED: LUXEON CX Plus CoB L04 / L05 (Gen2)
 Ordering code: CP18523_YASMEEN-35-S-B
 FWHM / FWTM: 30.0° / 60.0°
 Efficiency: 74 %
 Peak intensity: 2 cd/lm
 LEDs/each optic: 1
 Light colour/type: White
 Required components:

BJB: 47.360.1040

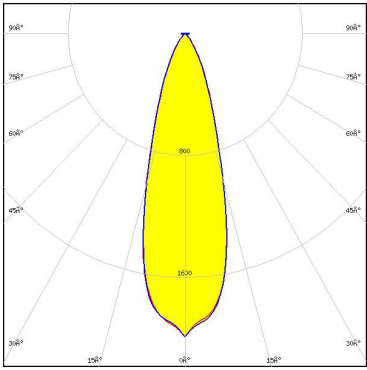

Light distribution files

LUMILEDS

LED: LUXEON CX Plus CoB S01 (Gen2)
 Ordering code: CP18523_YASMEEN-35-S-B
 FWHM / FWTM: 18.0° / 35.0°
 Efficiency: 91 %
 Peak intensity: 6.9 cd/lm
 LEDs/each optic: 1
 Light colour/type: White
 Required components:

Bender Wirth: 634c Bayonet35L

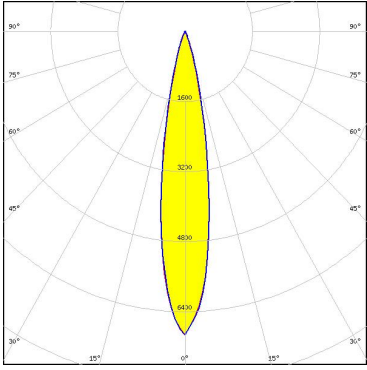

Light distribution files

LUMINUS

LED: CXM-3
 Ordering code: CP18523_YASMEEN-35-S-B
 FWHM / FWTM: 12.0° / 22.0°
 Efficiency: 91 %
 Peak intensity: 15.6 cd/lm
 LEDs/each optic: 1
 Light colour/type: White
 Required components:

Bender Wirth: 634a Bayonet35L

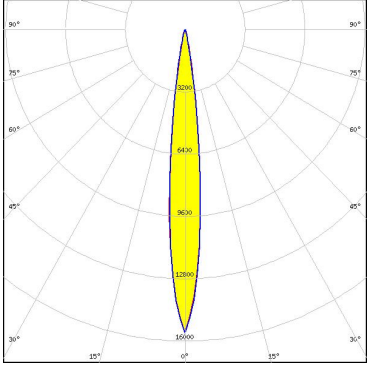

Light distribution files

OPTICAL RESULTS (SIMULATED):

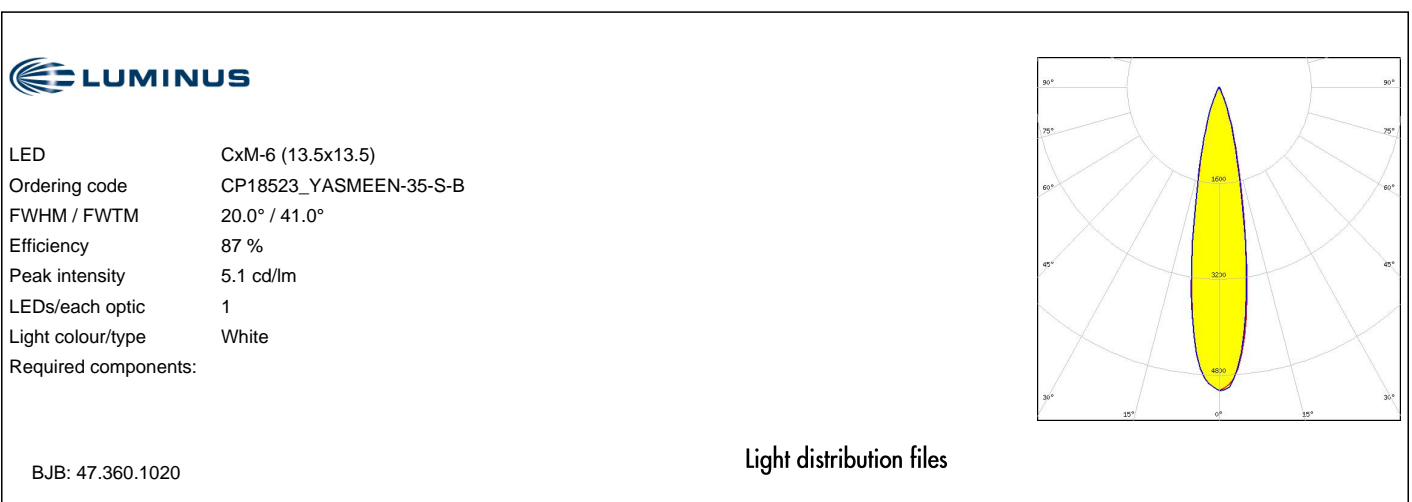
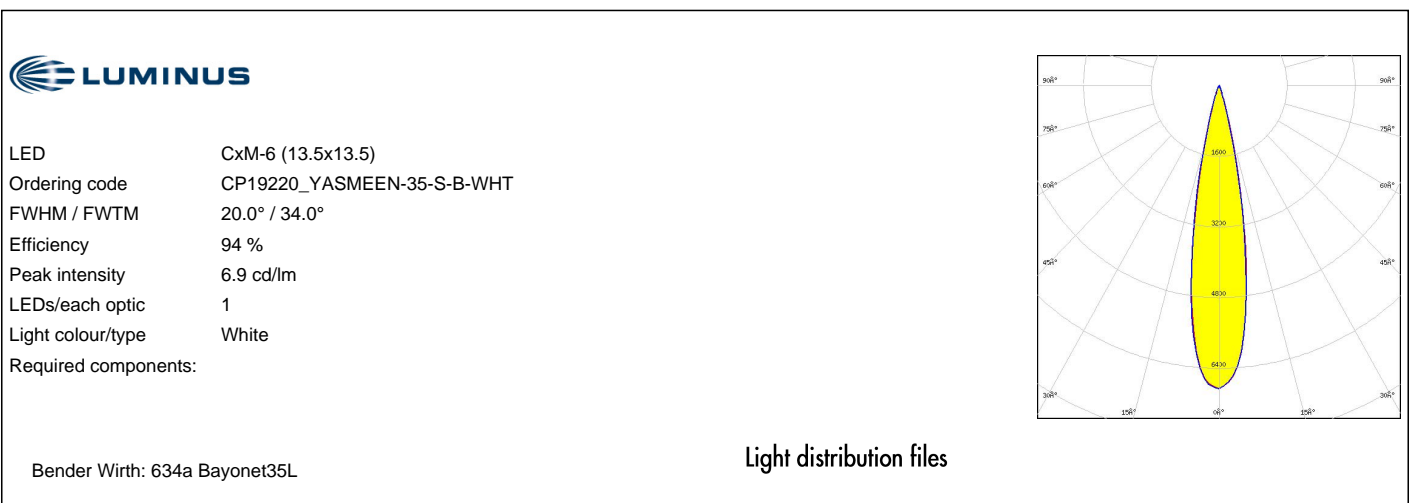
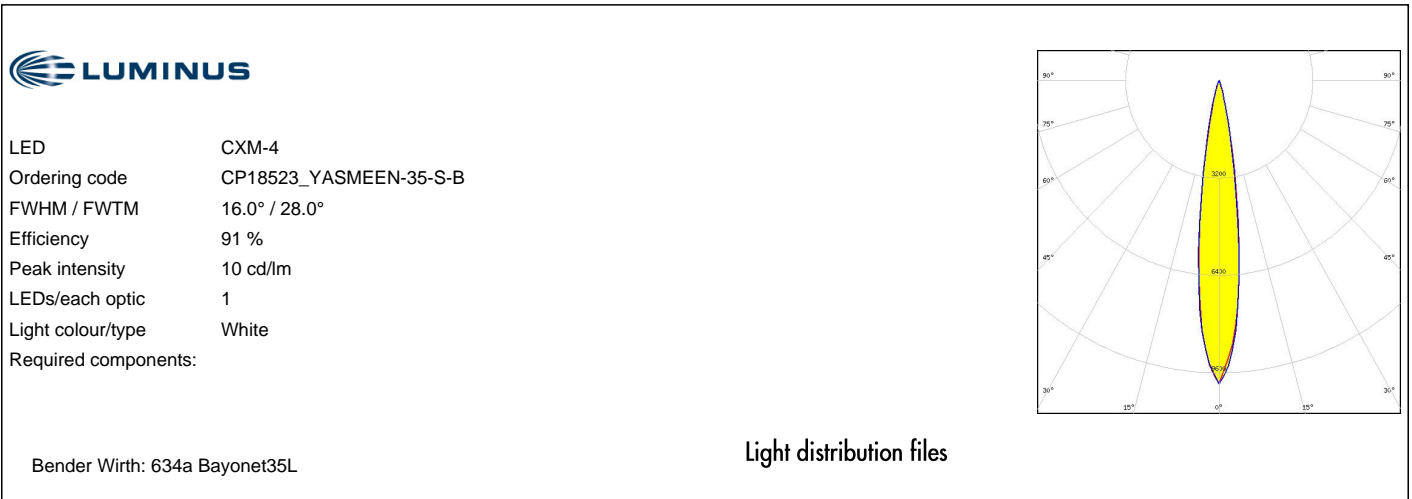

OPTICAL RESULTS (SIMULATED):



LED CxM-6 (13.5x13.5)
Ordering code CP18523_YASMEEN-35-S-B
FWHM / FWTM 20.0° / 38.0°
Efficiency 88 %
Peak intensity 6.2 cd/lm
LEDs/each optic 1
Light colour/type White
Required components:

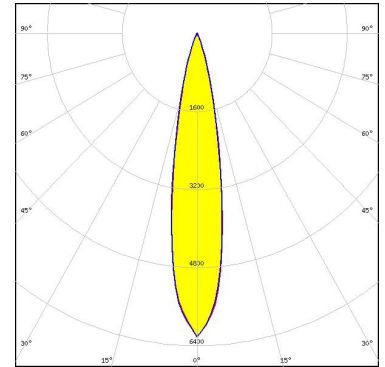

BJB: 47.360.1020

Light distribution files



LED COB S-Type (LES 6)
Ordering code CP18523_YASMEEN-35-S-B
FWHM / FWTM 20.0° / 36.0°
Efficiency 91 %
Peak intensity 6.7 cd/lm
LEDs/each optic 1
Light colour/type White
Required components:

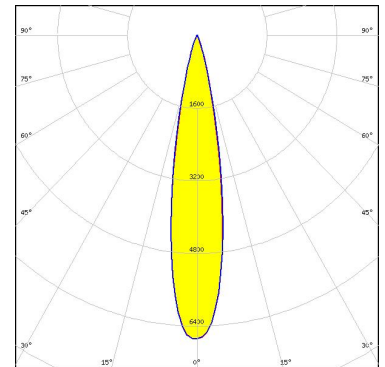

Bender Wirth: 652a Bayonet35L

Light distribution files



LED COB S-Type (LES 7)
Ordering code CP18523_YASMEEN-35-S-B
FWHM / FWTM 22.0° / 40.0°
Efficiency 91 %
Peak intensity 5.5 cd/lm
LEDs/each optic 1
Light colour/type White
Required components:

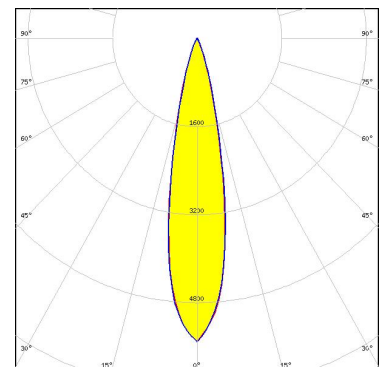

Bender Wirth: 652a Bayonet35L

Light distribution files

OPTICAL RESULTS (SIMULATED):

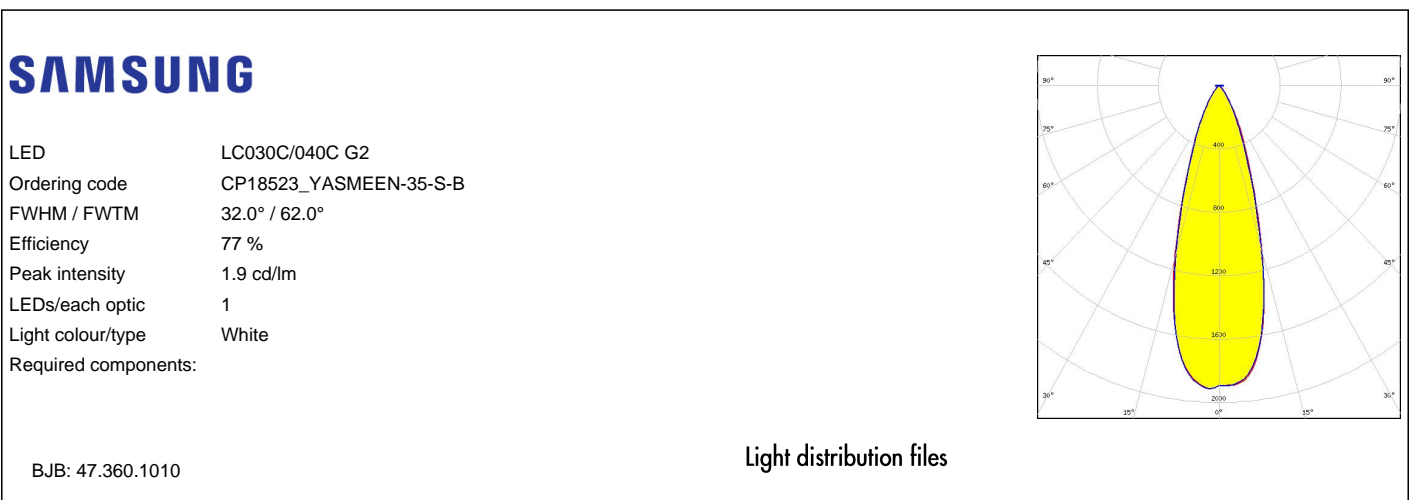
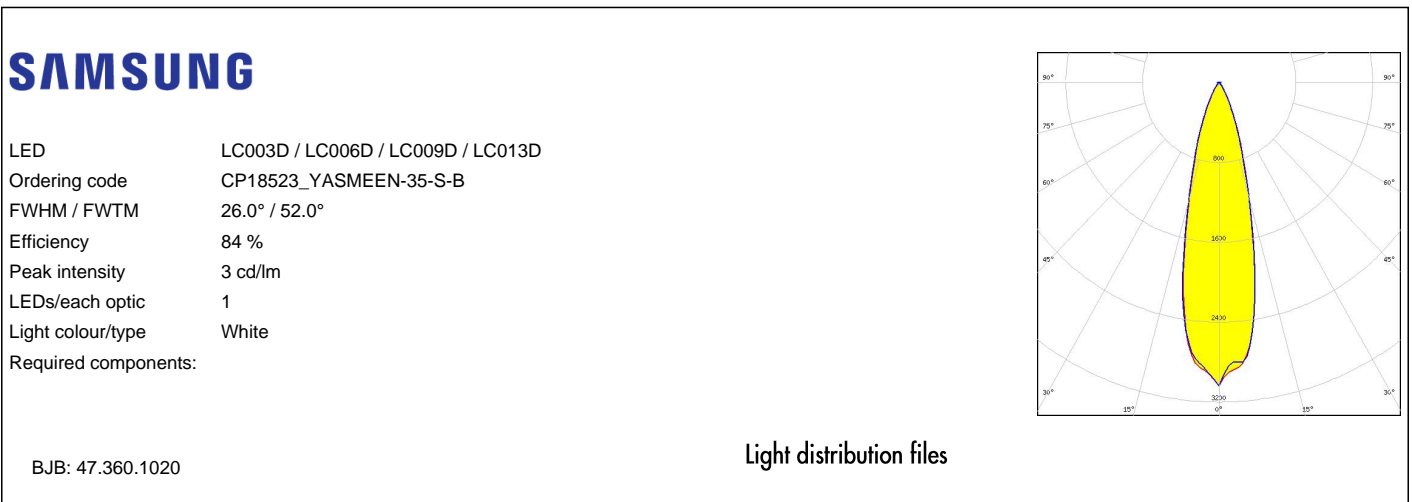
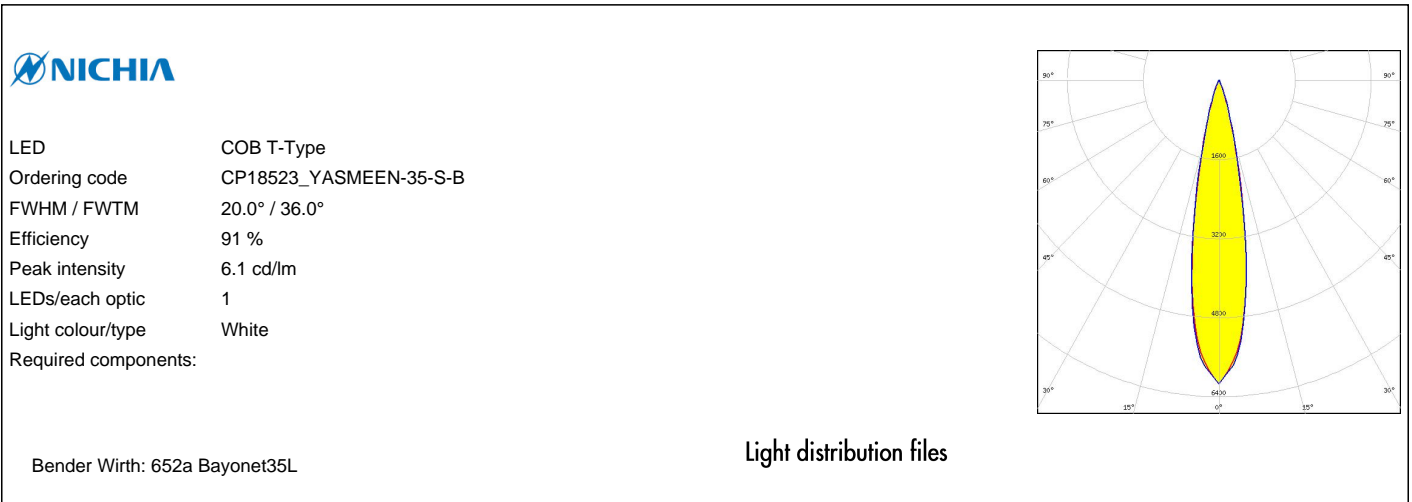

GENERAL INFORMATION:

NOTE: The typical beam angle will be changed by different color, chip size and chip position tolerance. The typical total beam angle is the full angle measured where the luminous intensity is half of the peak value.

Due to use of high power COB's with this product, special attention to proper thermal design is highly recommended. LEDiL has no liability for direct, indirect or consecutive damages arising from the LEDiL products being used outside of the recommended temperature range.

MATERIALS:

As part of our continuous research and improvement processes, and to ensure the best possible quality and availability of our products, LEDiL reserves the right to change material grades without notice.

PRODUCT DATA USER AGREEMENT AND DISCLAIMER:

The measured data in the provided downloadable LEDiL Product Datasheets and Mechanical 2D-Drawings is rounded and provided as reference for planning. LEDiL Oy's optical specifications have been verified by conducting performance testing of the products in accordance with the company's quality system. The reported data are averaged results of multiple measurements with typical variation. LEDiL Oy reserves the right to without prior notification make changes and improvements to its products.

LEDiL Oy assumes neither warranty, nor guarantee nor any other liability of any kind for the contents and correctness of the provided data. The provided data has been generated with highest diligence but the provided data may in reality not represent the complete possible variation range of all intrinsic parameters. Therefore, in certain cases a deviation from the provided data could occur.

LEDiL Oy reserves the right to undertake technical changes of its products without further notification which could lead to changes in the provided data. LEDiL Oy assumes no liability of any kind for the possible deviation from any provided data or any other damage resulting from the usage of the provided data.

The user agrees to this disclaimer and user agreement with the download or usage of the provided files.

LEDiL Oy

Joensuunkatu 13
FI-24240 SALO
Finland

LEDiL Inc.

228 West Page Street
Suite D
Sycamore IL 60178
USA

Ledil Optics Technology (Shenzhen) Co., Ltd.

405 , Block B
Casic Motor Building
Shenzhen 518057
P.R.CHINA

Local sales and technical support

[www.ledil.com/
where_to_buy](http://www.ledil.com/where_to_buy)

Shipping locations

Poznan, Poland
Hong Kong, China

Distribution Partners

[www.ledil.com/
where_to_buy](http://www.ledil.com/where_to_buy)