

Features

- $V_{DS} (V) = 20V$
- $R_{DS(ON)} < 46m\Omega$ ($V_{GS} = 4.5V$)
- $R_{DS(ON)} < 66m\Omega$ ($V_{GS} = 2.5V$)

Application(s)

- Load/ System Switch

Benefits

- Multi-vendor compatibility
- Environmentally friendly
- Increased Reliability

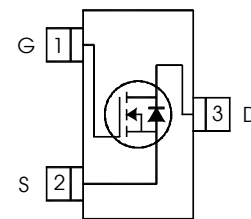
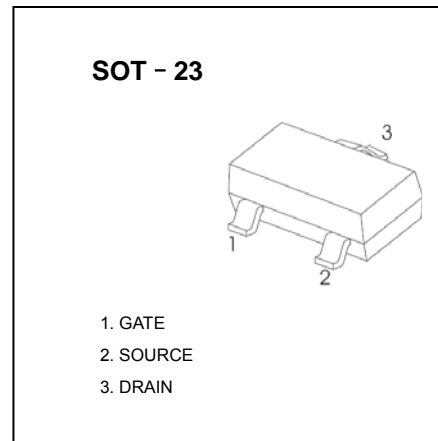

Absolute Maximum Ratings

Symbol	Parameter	Max.	Units
V_{DS}	Drain-Source Voltage	20	V
$I_D @ T_A = 25^\circ C$	Continuous Drain Current, $V_{GS} @ 10V$	4.1	A
$I_D @ T_A = 70^\circ C$	Continuous Drain Current, $V_{GS} @ 10V$	3.3	
I_{DM}	Pulsed Drain Current	16	
$P_D @ T_A = 25^\circ C$	Maximum Power Dissipation	1.3	W
$P_D @ T_A = 70^\circ C$	Maximum Power Dissipation	0.8	
	Linear Derating Factor	0.01	W/°C
V_{GS}	Gate-to-Source Voltage	± 12	V
T_J, T_{STG}	Junction and Storage Temperature Range	-55 to + 150	°C

Thermal Resistance

Symbol	Parameter	Typ.	Max.	Units
$R_{\theta JA}$	Junction-to-Ambient ^③		100	°C/W
$R_{\theta JA}$	Junction-to-Ambient ($t < 10s$) ^④		99	

Notes:

- ① Repetitive rating; pulse width limited by max. junction temperature.
- ② Pulse width $\leq 400\mu s$; duty cycle $\leq 2\%$.
- ③ Surface mounted on 1 in square Cu board

Electric Characteristics @ $T_J = 25^\circ\text{C}$ (unless otherwise specified)

Symbol	Parameter	Min.	Typ.	Max.	Units	Conditions
$V_{(BR)DSS}$	Drain-to-Source Breakdown Voltage	20			V	$V_G = 0V, I_D = 250\mu\text{A}$
$\Delta V_{(BR)DSS}/\Delta T_J$	Breakdown Voltage Temp. Coefficient		0.03		V/ $^\circ\text{C}$	Reference to $25^\circ\text{C}, I_D = 1\text{mA}$
$R_{DS(on)}$	Static Drain-to-Source On-Resistance		30	46	m Ω	$V_G = 4.5V, I_D = 4.1A$ ②
			45	66		$V_G = 2.5V, I_D = 3.3A$ ②
$V_{GS(th)}$	Gate Threshold Voltage	0.5	0.8	1.1	V	$V_D = V_G, I_D = 5\mu\text{A}$
I_{DSS}	Drain-to-Source Leakage Current			1.0	μA	$V_G = 16V, V_D = 0V$
				10		$V_G = 16V, V_D = 0V, T = 55^\circ\text{C}$
				150		$V_G = 16V, V_D = 0V, T = 125^\circ\text{C}$
I_{GSS}	Gate-to-Source Forward Leakage			100	nA	$V_D = 12V$
	Gate-to-Source Reverse Leakage			-100		$V_D = -12V$
R_G	Internal Gate Resistance		4.0		Ω	
g_{fs}	Forward Transconductance	10			S	$V_G = 10V, I_D = 4.1A$
Q_g	Total Gate Charge		3.5		nC	$I_D = 4.1A$
Q_{gs}	Gate-to-Source Charge		0.26			$V_G = 10V$
Q_{gd}	Gate-to-Drain ("Miller") Charge		1.7			$V_G = 4.5V$ ②
$t_{d(on)}$	Turn-On Delay Time		3.6		ns	$V_G = 10V$ ②
t_r	Rise Time		4.9			$I_D = 1.0A$
$t_{d(off)}$	Turn-Off Delay Time		11			$R_{\theta} = 6.8\Omega$
t_f	Fall Time		6.0			$V_G = 4.5V$
C_{iss}	Input Capacitance		290		pF	$V_D = 0V$
C_{oss}	Output Capacitance		64			$V_G = 16V$
C_{rss}	Reverse Transfer Capacitance		41			$f = 1.0\text{MHz}$

Source - Drain Ratings and Characteristics

Symbol	Parameter	Min.	Typ.	Max.	Units	Conditions
I_S	Continuous Source Current (Body Diode)			1.3	A	MOSFET symbol
I_{SM}	Pulsed Source Current (Body Diode) ①			16		integral reverse
V_{SD}	Diode Forward Voltage			1.2	V	$T = 25^\circ\text{C}, I_D = 4.1A, V_G = 0V$ ②
t_{rr}	Reverse Recovery Time		8.6	13	ns	$T = 25^\circ\text{C}, V_G = 15V, I_D = 1.3A$
Q_{rr}	Reverse Recovery Charge		2.8	4.2		$di/dt = 100A/\mu\text{s}$ ②



TYPICAL CHARACTERISTICS 25 °C, unless otherwise noted

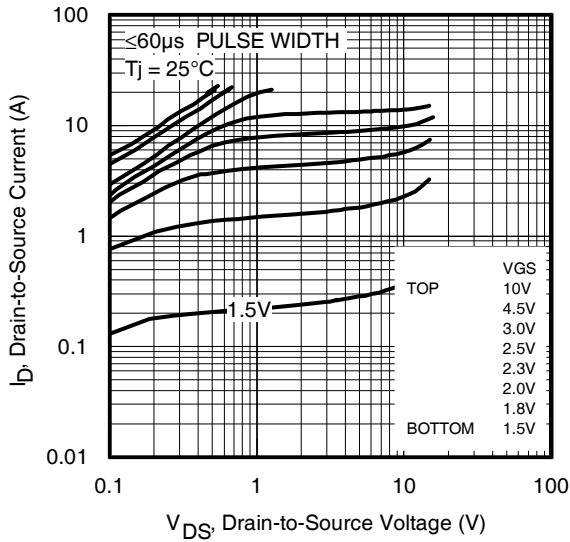

Fig 1. Typical Output Characteristics

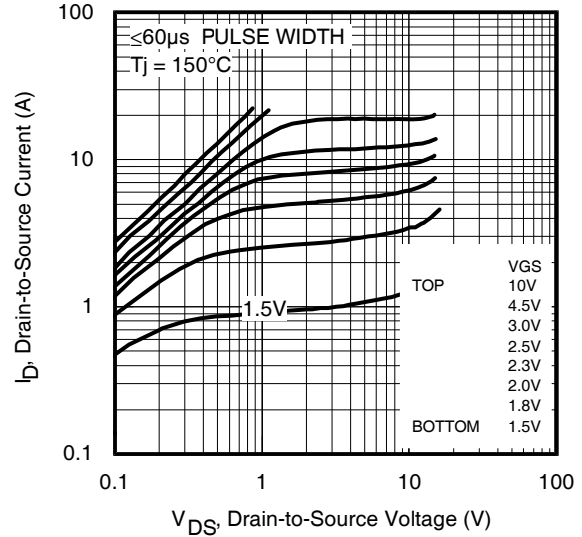

Fig 2. Typical Output Characteristics

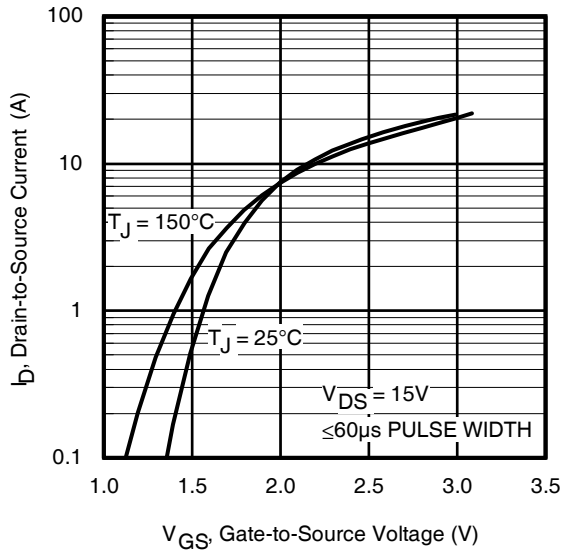

Fig 3. Typical Transfer Characteristics

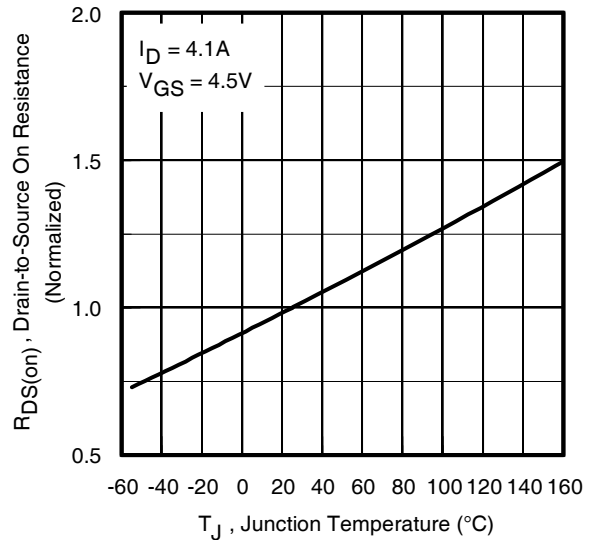
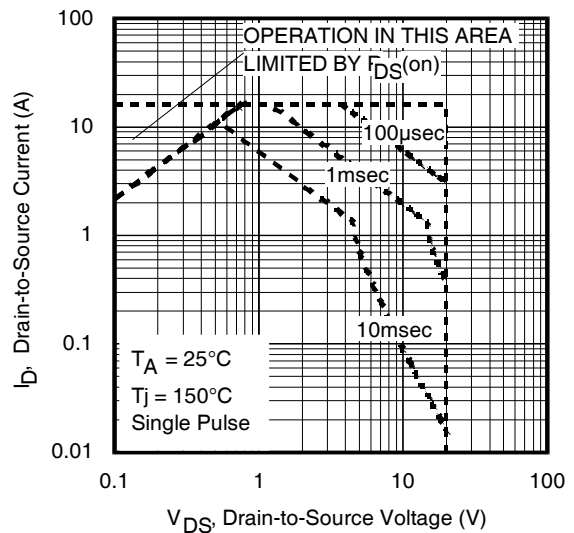
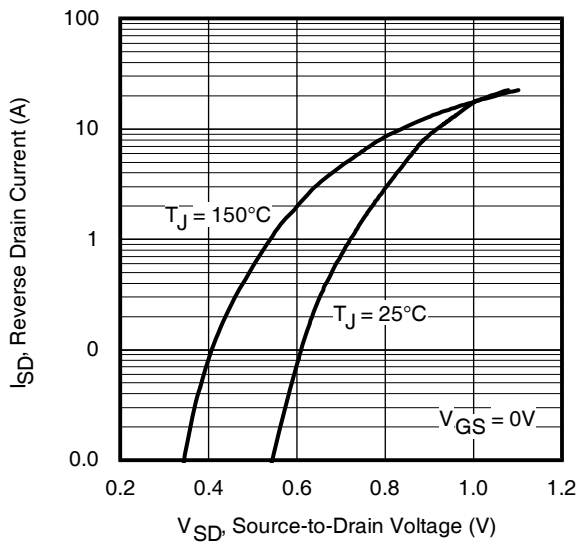
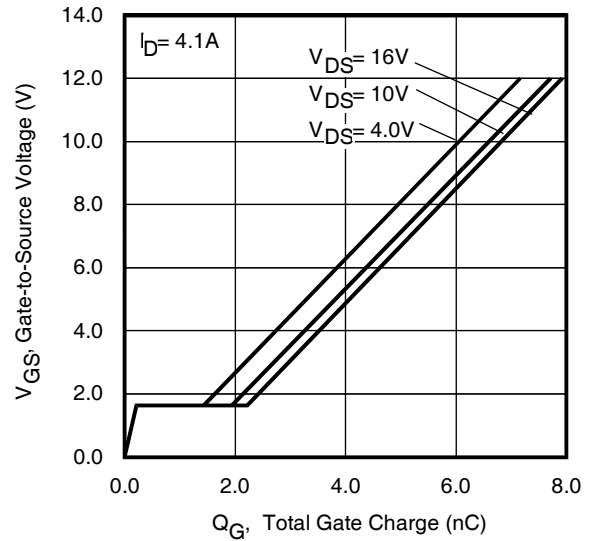
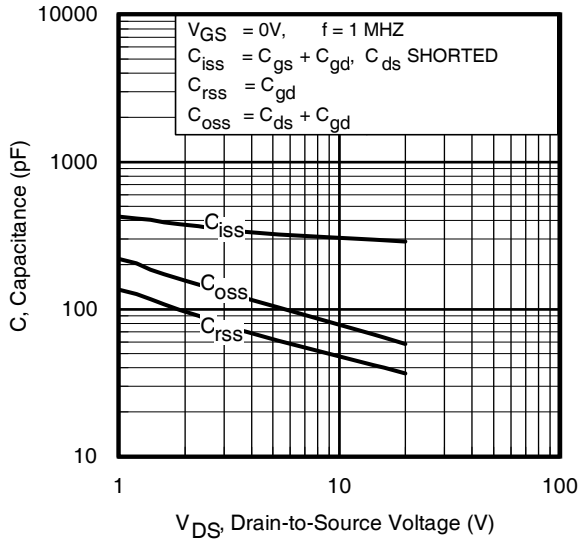

Fig 4. Normalized On-Resistance Vs. Temperature

TYPICAL CHARACTERISTICS 25 °C, unless otherwise noted



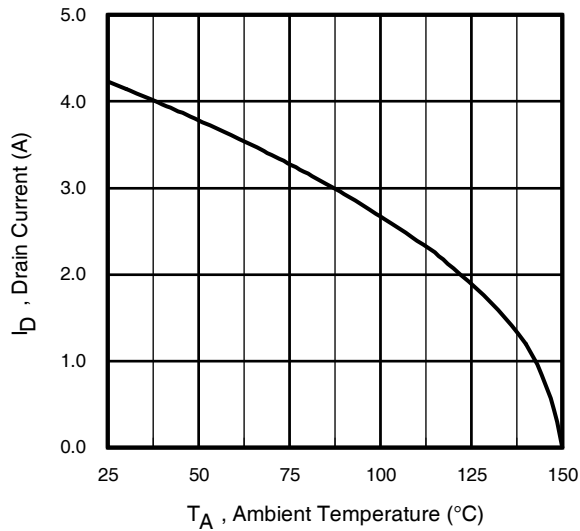

Fig 9. Maximum Drain Current Vs. Ambient Temperature

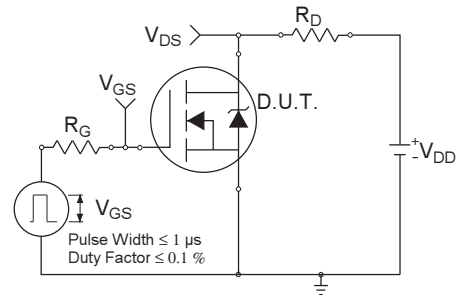

Fig 10a. Switching Time Test Circuit

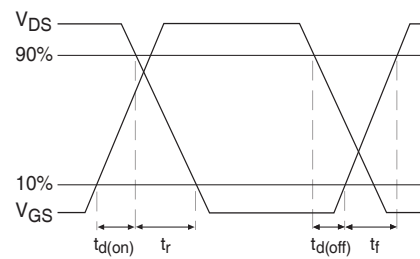

Fig 10b. Switching Time Waveforms

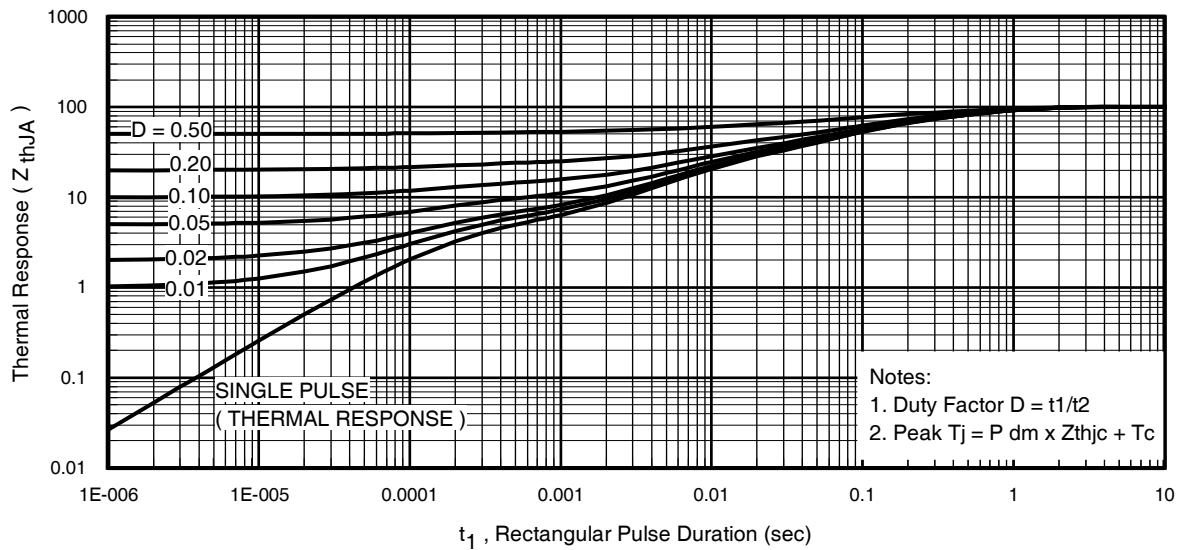

Fig 11. Typical Effective Transient Thermal Impedance, Junction-to-Ambient

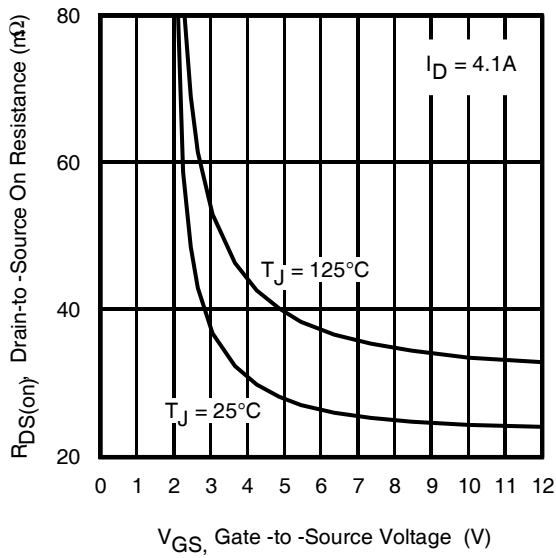

Fig 12. Typical On-Resistance Vs. Gate Voltage

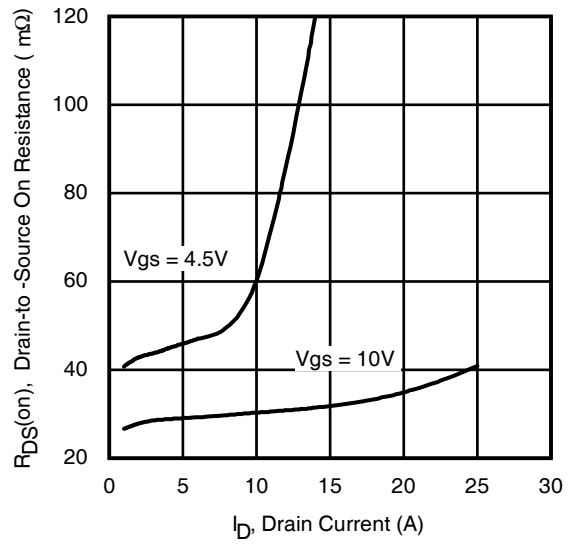

Fig 13. Typical On-Resistance Vs. Drain Current

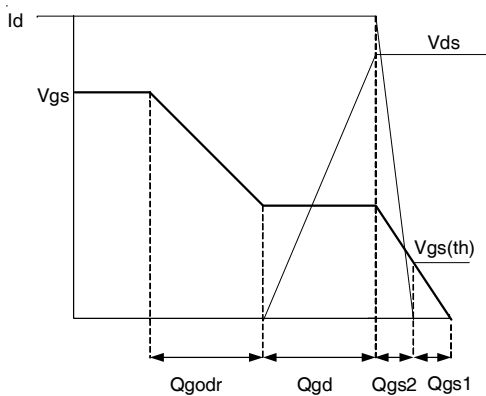

Fig 14a. Basic Gate Charge Waveform

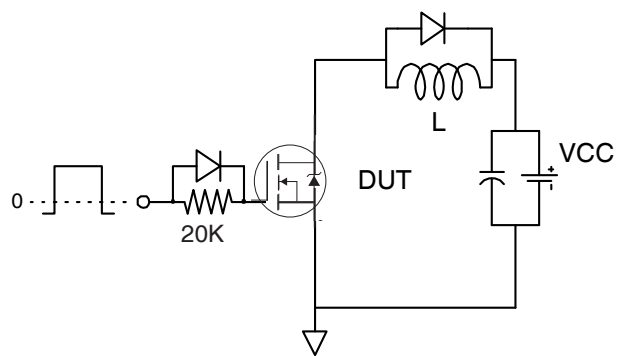

Fig 14b. Gate Charge Test Circuit

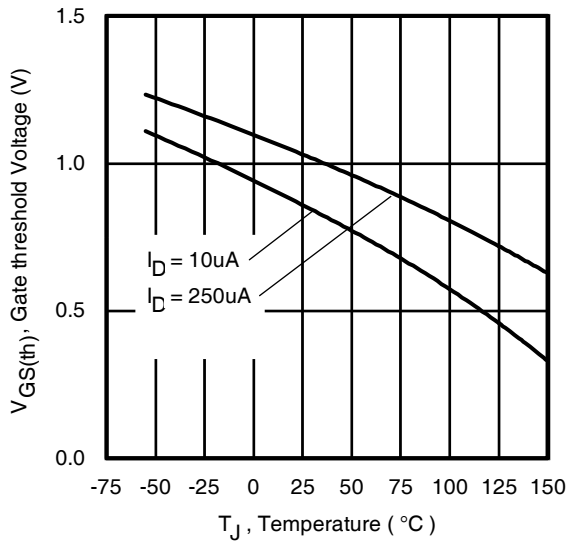

Fig 15. Typical Threshold Voltage Vs. Junction Temperature

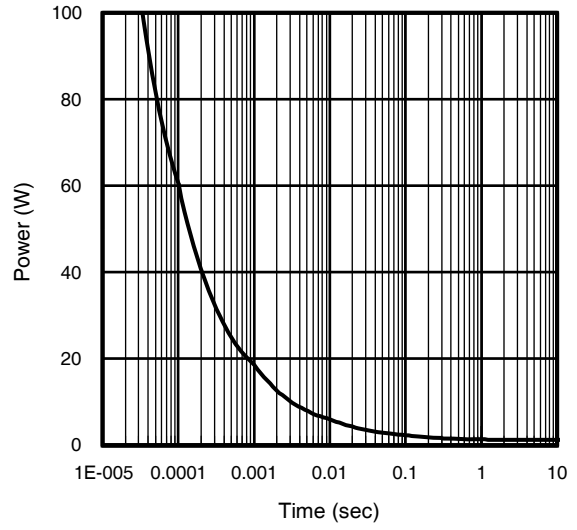
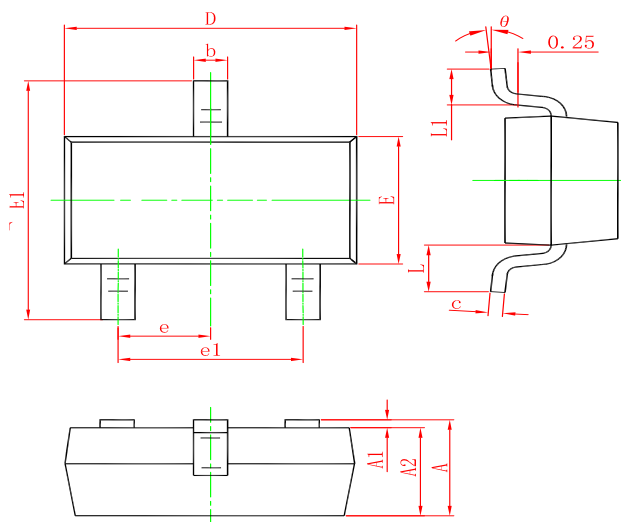

Fig 16. Typical Power Vs. Time

SOT-23 PACKAGE OUTLINE DIMENSIONS



Symbol	Dimensions In Millimeters		Dimensions In Inches	
	Min.	Max.	Min.	Max.
A	0.900	1.150	0.035	0.045
A1	0.000	0.100	0.000	0.004
A2	0.900	1.050	0.035	0.041
b	0.300	0.500	0.012	0.020
c	0.080	0.150	0.003	0.006
D	2.800	3.000	0.110	0.118
E	1.200	1.400	0.047	0.055
E1	2.250	2.550	0.089	0.100
e	0.950 TYP.		0.037 TYP.	
e1	1.800	2.000	0.071	0.079
L	0.550 REF.		0.022 REF.	
L1	0.300	0.500	0.012	0.020
θ	0°	8°	0°	8°

Marking

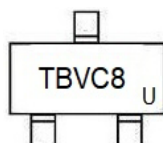

Ordering information

Order code	Package	Baseqty	Deliverymode
UMW IRLML6246TR	SOT-23	3000	Tape and reel