

REV.	ECN NO.	APPD	DATE
A1	15.5±0.3mm	Jacky	180324

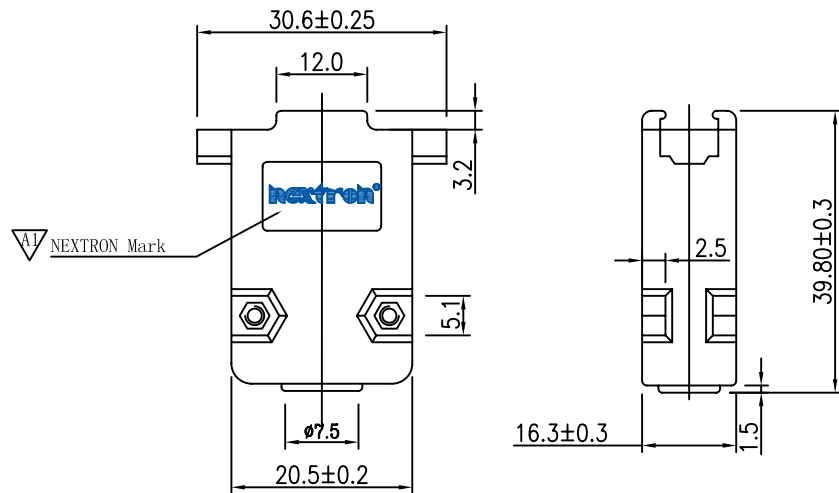

① 塑胶主体 (9PIN)

**SPECIFICATIONS:**

Current rating:NONE

Voltage rating:NONE

Contact resistance:NONE

Insulation resistance:1000M ohm MIN

Withstanding voltage:1000V AC for one minute

Operating temperature range:-25°C~+80°C(ABS)

-25°C~+60°C(HIPS)

**MATERIAL AND FINISH**

Insulator:ABS or HIPS (UL94V-0)

Contact:Copper Alloy

Finish:Zn Plated or Cr Plated

**Ordering Information**

SUB - BOX0 - 002X - XXX

Number of contacts

Code	Definition
A	9 PIN
B	15 PIN
C	25 PIN
E	37 PIN

Fitting Plated

Code	Definition
N	Ni
P	Colour Zn
Q	Blue Zn
R	Cr <sup>3+</sup>

Insulator material/Plated

Code	Definition
D	ABS No Plated
E	ABS Cr Plated
H	HIPS No Plated

Insulator color

Code	Definition
0	Black
8	Gray
L	Ivory White

Mark

Code	Definition
0	No Mark
2	Nextron Mark

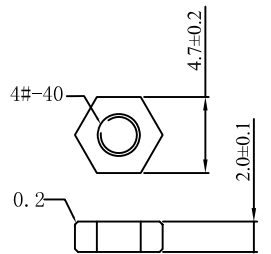

② 塑胶螺母 (通用)

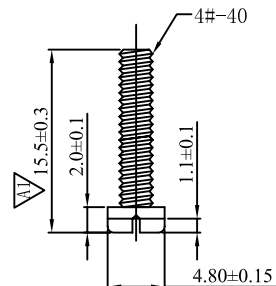

③ 塑壳螺丝 (通用)

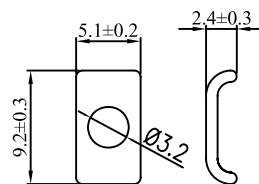

④ 卡片 (通用)

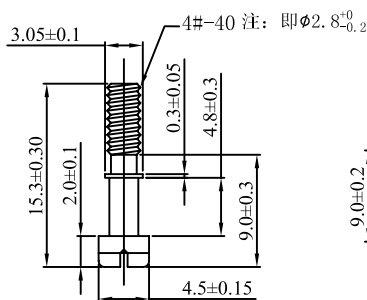

⑤ 卡片螺丝 (通用)

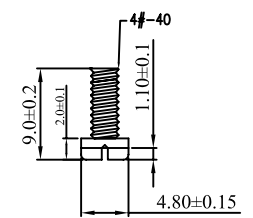

⑥ 线夹螺丝 (通用)

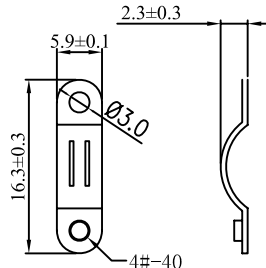

⑦ 线夹 (9Pin)

X ±0.3	UNITS	MM	NAME: D-SUB HOOD 9P	深圳市君灏精密工业有限公司 SHENZHEN JUNHAO ENGINEERING CO., LTD
.X ±0.1	MAT'L	PART NO.: SEE TABLE	TITLE: D-SUB HOOD 9P	
.XX ±0.05	FINISH	APPD: Jonson(2018.03.24)	DWG NO.: SUB-B0A0-0020-H82	
X° ±2°	CHKD: Jeff(2018.03.24)	DR: Jacky(2018.03.24)	SCALE SHEET REV. 1:1 1/1 A1	
<small>THESE DRAWINGS AND SPECIFICATIONS ARE THE PROPERTY OF JUNHAO ENGINEERING CO.,LTD. AND SHALL NOT BE REPRODUCED, COPIED OR USED IN ANY MANNER WITHOUT THE PRIOR WRITTEN CONSENT OF JUNHAO ENGINEERING CO.,LTD.</small>				