

**NEW**



# ES9 Series

## Spring Lock Connector

CONNECTOR

MB-0264-1

July 2013

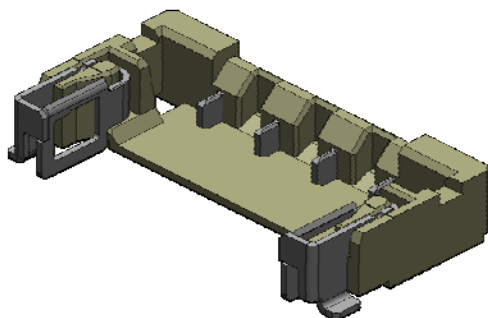

**RoHS Compliant**

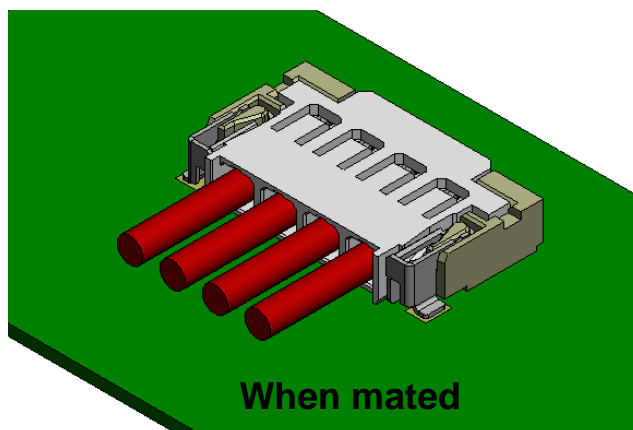
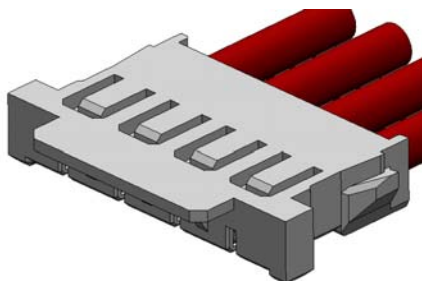

### Features

- Improved operability through upper-side mating. Easy to visually confirm the connector is mated.
- Original locking design structure (Spring Lock) achieves high retention strength in the cable lifting direction.  
Cable lifting-direction retention strength: 15N min.
- Improved contact reliability with a 2-point contact structure.
- 22AWG (outer cable diameter: 2.1mm max.) compatible with a low-profile structure (product height: 3mm).

### General Specifications

- |  |  |
|--|--|
| ■ No. of Contacts: 2, 4 positions  | ■ Retention Strength: 15N min.   |
| ■ Contact Resistance: 30m $\Omega$ max. (initial),<br>45m $\Omega$ max. (after test) | ■ Insulation Resistance: 10M $\Omega$ min.                             |
| ■ Voltage: AC/DC 300V  | ■ Mating Cycles: 10 times  |
| ■ Current: 4A per position (for 2-position)<br>3A per position (for 4-position)      | ■ Operating Temperature:<br>-40 Deg. C to +105 Deg. C                  |
|  | ■ Applicable Wire: 22 to 26AWG<br>(Outer cable diameter: 1.0 to 2.1mm) |

Materials and Finishes

Component	Item	Material and Finish
Plug (Board side)	Insulator	LCP resin
	Contact	Copper alloy / Sn plating
	Hold down	Copper alloy / Sn plating over Ni
Socket (Cable side)	Housing	Nylon resin
	Crimp contact	Copper alloy / Sn plating

Ordering Information

**ES9 P 00 \* V F Z (R 1 6 0 0)**

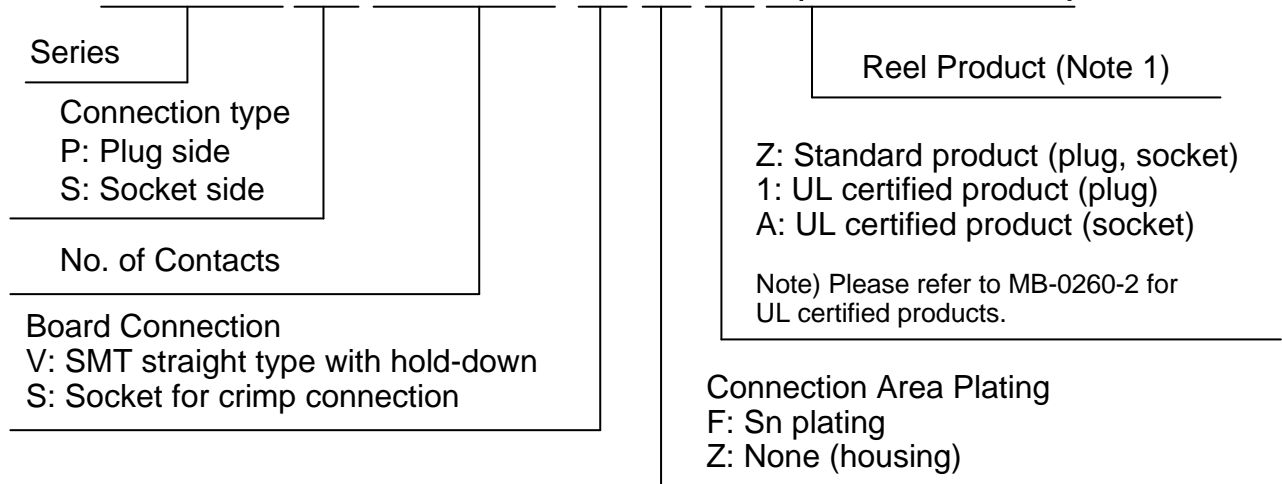

Note 1: An embossed tape reel contains 1,600 pieces.

**ES9 S 06K 4 F A**

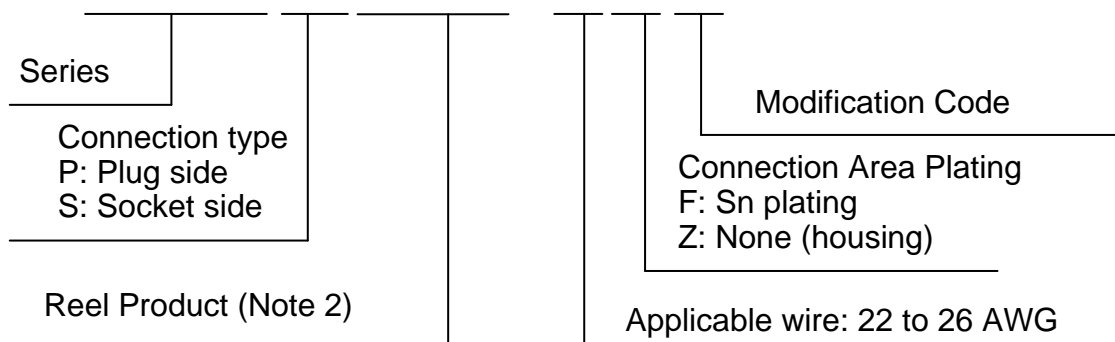

Note 2: A carrier tape reel contains 6,000 pieces.

Product Drawing

■ ES9P00\*VFZ

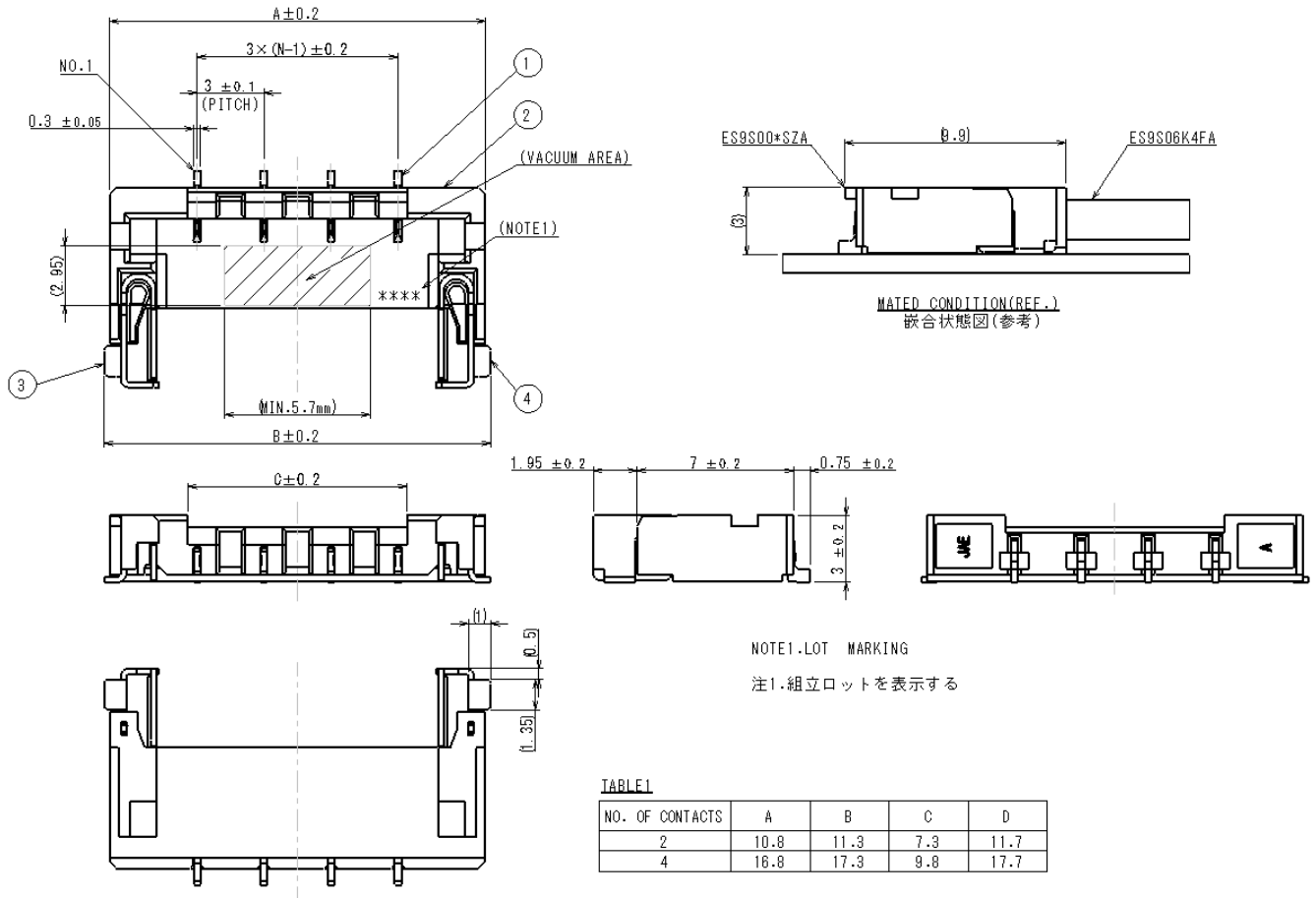

■ ES9P00\*VFZR1600

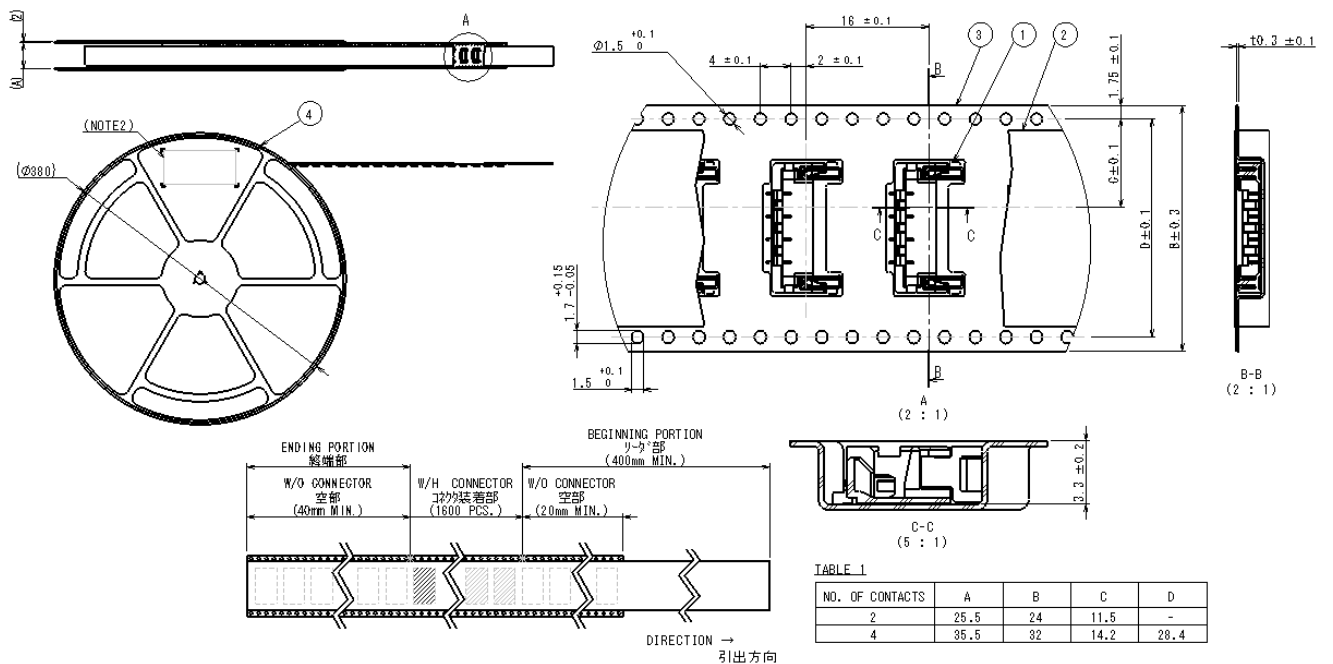



<Applicable Board Dimensions>

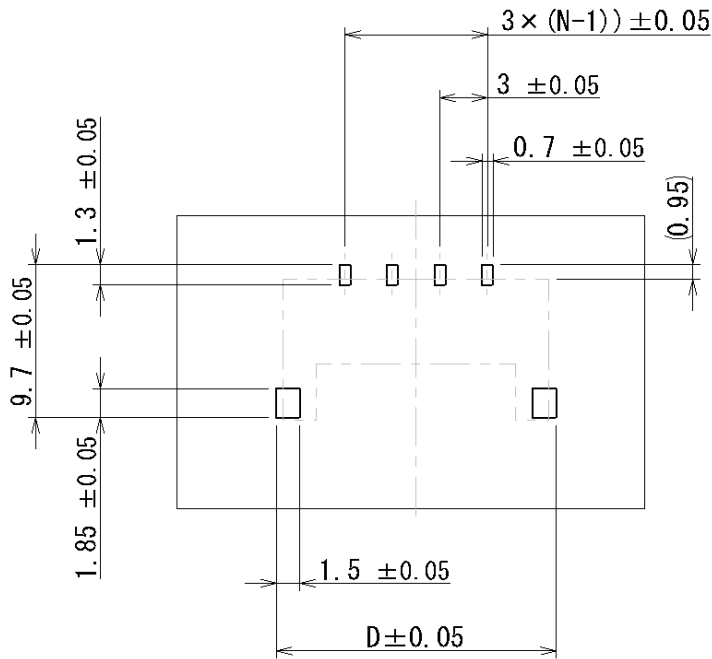

APPLICABLE P.C.B. DIMENSION (REF.)  
適合基板寸法 (参考)

Drawing Number

Part Number	Drawing No.
ES9P00*VFZ	SJ114446
ES9S00*VFZR1600	SJ114447
ES9S00*SZZ	SJ114448
ES9S06K4FA	SJ113516

Crimping Tool

Cable Size	Hand Tool	Semi-automatic Applicator
22 to 26AWG	CT150-4-ES9	3502-ES9-2

Technical Documents
---------------------

Specifications	JACS-11001
Handling Instructions	JAHL-11001

**Notice:**

1. The values specified in this brochure are only for reference. The products and their specifications are subject to change without notice. Contact our sales staff for further information before considering or ordering any of our products. For purchase, a product specification must be agreed upon.
2. Users are requested to provide protection circuits and redundancy circuits to ensure safety of the equipment, and sufficiently review the suitability of JAE's products to the equipment.
3. The products presented in this brochure are designed for the uses recommended below. We strongly suggest you contact our sales staff when considering use of any of the products in any other way than the recommended applications or for a specific use that requires an extremely high reliability.
  - (1) Applications that require consultation:
    - (i) Please contact us if you are considering use involving a quality assurance program that you specify or that is peculiar to the industry, such as:  
Automotive electrical components, train control, telecommunications devices (mainline), traffic light control, electric power, combustion control, fire prevention or security systems, disaster prevention equipment, etc.
    - (ii) We may separately give you our support with a quality assurance program that you specify, when you think of a use such as :  
Aviation or space equipment, submarine repeaters, nuclear power control systems, medical equipment for life support, etc.
  - (2) Recommended applications include:  
Computers, office appliances, telecommunications devices (terminals, mobile units), measuring equipment, audiovisual equipment, home electric appliances, factory automation equipment, etc

**Japan Aviation Electronics Industry, Limited**

Product Marketing Division  
 Aobadai Building, 3-1-19, Aobadai, Meguro-ku, Tokyo 153-8539  
 Phone: +81-3-3780-2882 FAX: +81-3-3780-2946

\* The specifications in this brochure are subject to change without notice. Please contact JAE for information.

# Mouser Electronics

Authorized Distributor

Click to View Pricing, Inventory, Delivery & Lifecycle Information:

[JAE Electronics:](#)

[ES9P002VF1R1600](#) [ES9P004VF1R1600](#) [ES9S002SZA](#) [ES9S004SZA](#) [ES9S06K4FA](#) [CT150-4-ES9](#) [ES9S002SZZ](#)