

# 1XC0394-0T0-10

## PHYSICAL DIMENSIONS:

A	10.00	±	0.15
A1	14.00		MAX
B	30.00	±	0.30
C	8.00	±	1.00
D	26.50	±	1.00
E	12.00	±	0.50
F	1.20	±	0.10

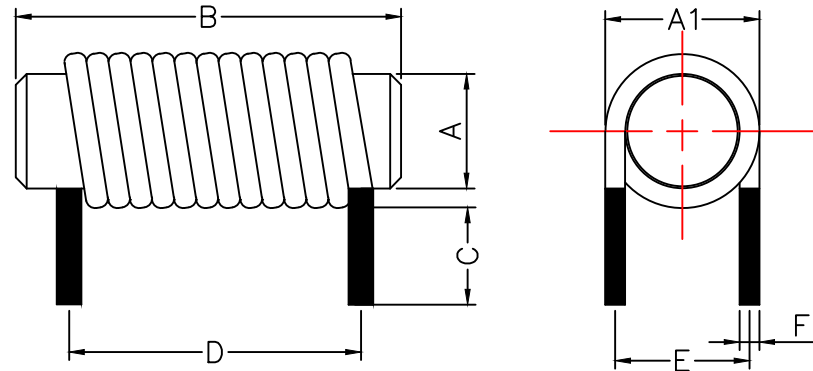

## ELECTRICAL SPECIFICATION

	Min	Norm	Max
INDUCTANCE ( $\mu$ H) L @ 10KHz/0.1V $\pm 25\%$	11.25	15.00	18.75
DCR ( $\Omega$ )			0.016
Rated Current(A)	9.0		

NOTES: UNLESS OTHERWISE SPECIFIED

1. WIRE SPEC: AWG#17H-MW35 20.5Ts.

2. DEFINITION OF RATED CURRENT CURRENT (IRMS):

DC CURRENT THAT CAUSES THE TEMPERATURE RISE ( $\Delta T \leq 40^\circ\text{C}$ ) FROM  $25^\circ\text{C}$  AMBIENT.

3. OPERATION TEMPERATURE RANGE:

$-40^\circ\text{C}$  TO  $+150^\circ\text{C}$  (INCLUDING SELF-HEATING).

RoHS

DIMENSIONS ARE IN mm (INCHES).				This print is the property of Laird Tech. and is loaned in confidence subject to return upon request and with the understanding that no copies shall be made without the written consent of Laird Tech. All rights to design or invention are reserved.		Laird	
PROJECT/PART NUMBER:				REV	PART TYPE:	DRAWN BY:	
1XC0394-0T0-10				A		QIU	
DATE: 01/08/15				SCALE:	NTS	SHEET:	
A ORIGINAL DRAFT				01/08/15	QIU	1 of 1	
REV	DESCRIPTION	DATE	INT	CAD #	TOOL #	1XC0394-0T0-10-A	
					-		