

User's Guide

Using the TPSM13604HEVM



ABSTRACT

The Texas Instruments TPSM13604H evaluation module (EVM) helps designers evaluate the operation and performance of the TPSM13604H synchronous-buck power module. The EVM is configured for operation with typical 5-V to 36-V input bus applications and output voltage options (3.3-V, 5-V, 9.5-V, 12-V, and 16-V) are set to one of five popular values by using a configuration jumper. Input and output capacitors are included on the board to accommodate the full current capability, entire range of input voltage, and selectable output voltages on the EVM. Jumpers are provided for setting the appropriate switching frequency and testing the desired output voltage. The recommended PCB layout of the EVM maximizes thermal performance.

Table of Contents

1 Getting Started	2
2 Test Point Descriptions	3
3 Performance Data	4
4 EVM Board Physical Specifications	5
4.1 Board Layout.....	5
4.2 EVM Schematic.....	11
4.3 Bill of Materials (BOM).....	11

List of Figures

Figure 1-1. EVM User Interface.....	2
Figure 3-1. TPSM13604HEVM ENABLE Start-Up Waveform.....	4
Figure 3-2. TPSM13604HEVM ENABLE Shutdown Waveform.....	4
Figure 3-3. TPSM13604HEVM Transient Performance (VIN = 24-V; VOUT = 9-V; IOOUT = 1-A to 4-A).....	4
Figure 3-4. TPSM13604HEVM Output Ripple (VIN = 24-V; VOUT = 9-V; IOOUT = 4-A).....	4
Figure 4-1. Top Silk Screen (Top View).....	5
Figure 4-2. Top Copper Layer.....	6
Figure 4-3. Signal Layer 1.....	7
Figure 4-4. Signal Layer 2.....	8
Figure 4-5. Bottom Copper Layer.....	9
Figure 4-6. Bottom Layer Silk Screen (Bottom View).....	10
Figure 4-7. TPSM13604HEVM Schematic.....	11
Figure 4-8. TPSM13604HEVM BOM.....	11

List of Tables

Table 2-1. Test Point Descriptions	3
--	---

Trademarks

All trademarks are the property of their respective owners.

1 Getting Started

Figure 1-1 details the user interface items associated with the EVM. The VIN terminal block (J1) is used for connection to the host input supply and the VOUT terminal block (J2) is used for connection to the load. These terminal blocks accept up to 14-AWG wire.

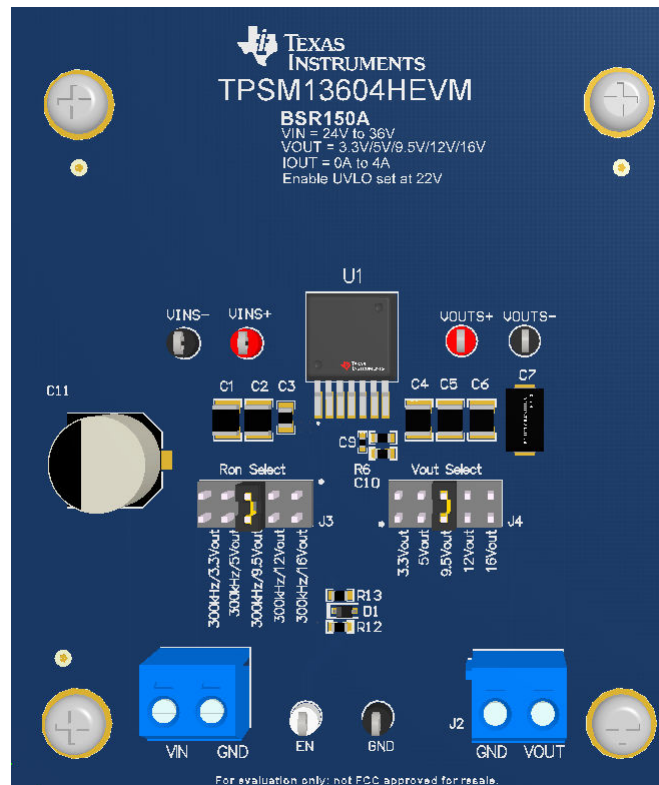

Figure 1-1. EVM User Interface

- Use the VIN S+ and VIN S- test points along with the VOUT S+ and VOUT S- test points located near the power terminal blocks as voltage monitoring points where voltmeters can be connected to measure VIN and VOUT. **Do not use these S+ and S- monitoring test points as the input supply or output load connection points.** The PCB traces connecting to these test points are not designed to support high currents.
- The control test points located near the bottom of the EVM test the features of the device. For more information on the individual control test points, see [Section 2](#).
- The Ron Select jumper (J3) is provided to set the switching frequency according to the set output voltage. To set the switching frequency to a different value, change the appropriate Ron resistor according to the device-specific data sheet equation.
- The Vout Select jumper (J4) is provided to select the desired output voltage: 3.3-V, 5-V, 9.5-V, 12-V, and 16-V. **Before applying power to the EVM, make sure that the jumper is present and properly positioned for the intended output voltage.** Always remove input power before changing the jumper settings.
- The device is configured to turn on with an under-voltage lockout (UVLO) of 22-V. The UVLO can be modified to a different desired voltage by changing the R13 resistor on the EVM.

2 Test Point Descriptions

Wire-loop test points and scope probe sockets are included for digital voltmeters (DVM) or oscilloscope probes to aid in the evaluation of the device. [Table 2-1](#) describes each test point.

For the absolute maximum ratings associated with the features listed in the following table, see the device-specific data sheet.

Table 2-1. Test Point Descriptions

VIN S+	Input voltage monitor. Connect the positive lead of a DVM to this point for measuring efficiency.
VIN S-	Input ground monitor. Connect the negative lead of a DVM to this point for measuring efficiency.
VOUT S+	Output voltage monitor. Connect the positive lead of a DVM to this point for measuring efficiency, line regulation, and load regulation.
VOUT S-	Output ground monitor. Connect the negative lead of a DVM to this point for measuring efficiency, line regulation, and load regulation.
GND	Ground test point. Connect the negative lead of a DVM to this point when measuring efficiency, line regulation, and load regulation.
EN	Enable test point. Monitor the Enable signal using this test point.

3 Performance Data

Figure 3-1 and Figure 3-2 shows the enable and shutdown of the TPSM13604HEVM. See Figure 3-3 for transient response waveforms (1-A to 4-A load step) and Figure 3-4 for output ripple. The default output capacitance configured on the EVM is optimized for an output voltage of 5.0-V and 3.3-V. The output voltage tested below are for an output voltage of 9-V and switching frequency of approximately 300-kHz by placing shunt on J4 Pins 5 and 6, changing R9 resistor to 3.32k Ω and R3 resistor to 232k Ω , and placing shunt on J3 Pins 5 and 6.

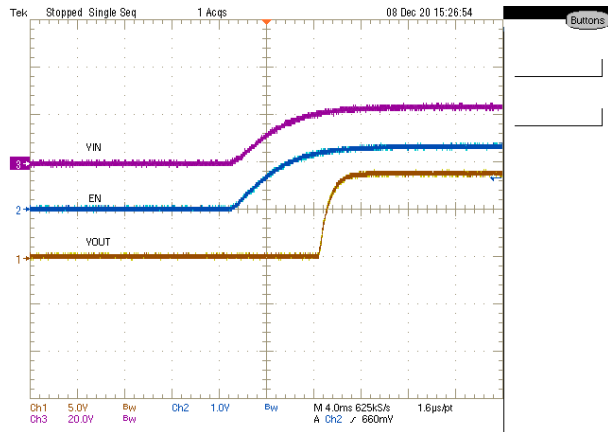

Figure 3-1. TPSM13604HEVM ENABLE Start-Up Waveform

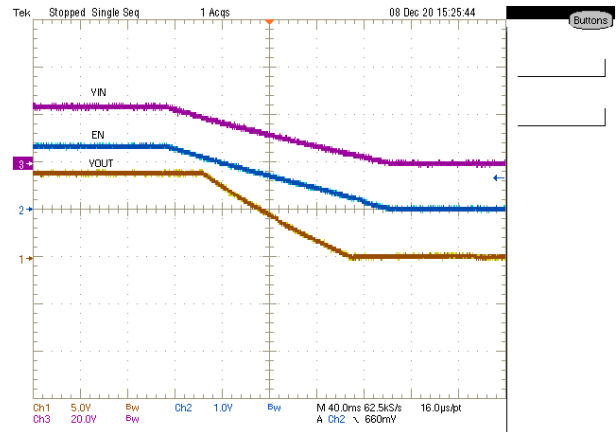

Figure 3-2. TPSM13604HEVM ENABLE Shutdown Waveform

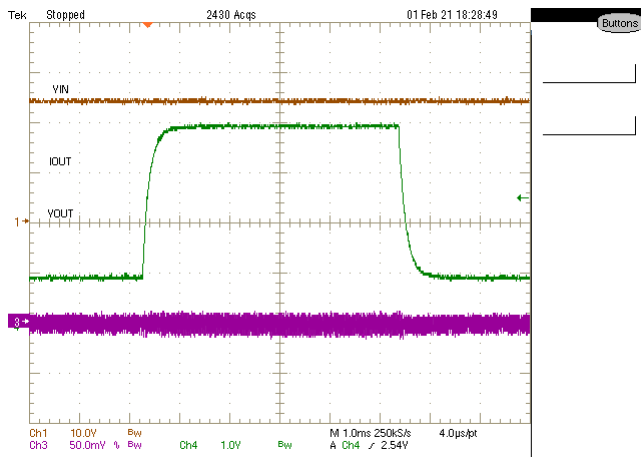

Figure 3-3. TPSM13604HEVM Transient Performance (VIN = 24-V; VOUT = 9-V; IOU = 1-A to 4-A)

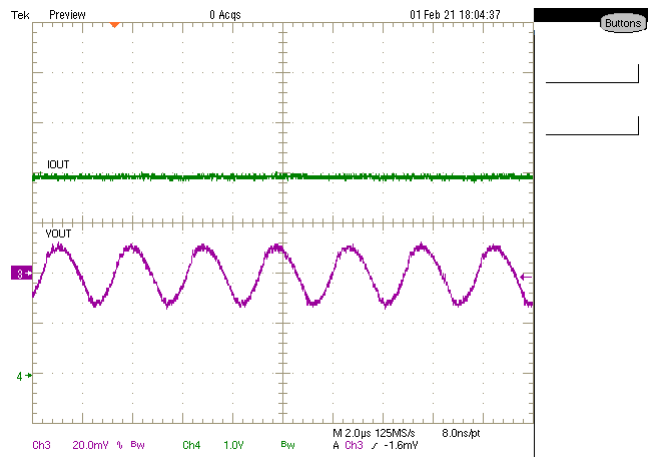

Figure 3-4. TPSM13604HEVM Output Ripple (VIN = 24-V; VOUT = 9-V; IOU = 4-A)

4 EVM Board Physical Specifications

This section describes the physical layout of the EVM board, the schematic, and the bill of materials (BOM).

4.1 Board Layout

The EVM board dimensions are 76-mm × 89-mm (3000-mils x 3500-mils). Figure 4-1 through Figure 4-6 show the EVM board layers.

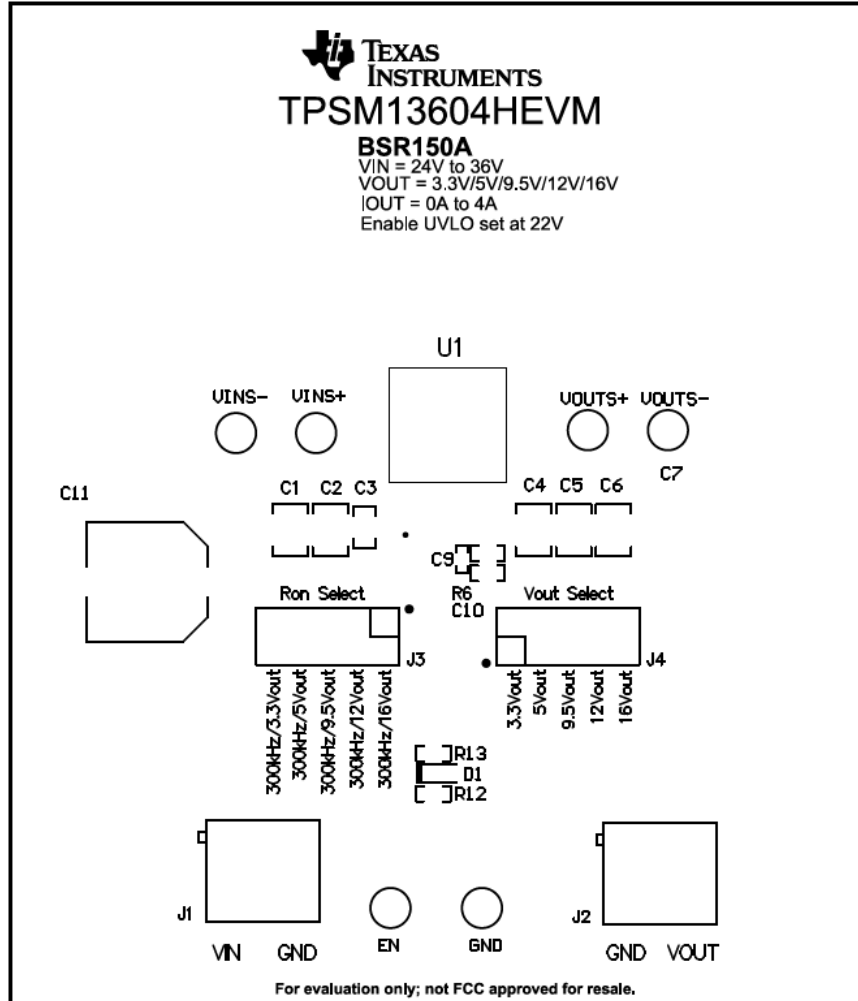

Figure 4-1. Top Silk Screen (Top View)

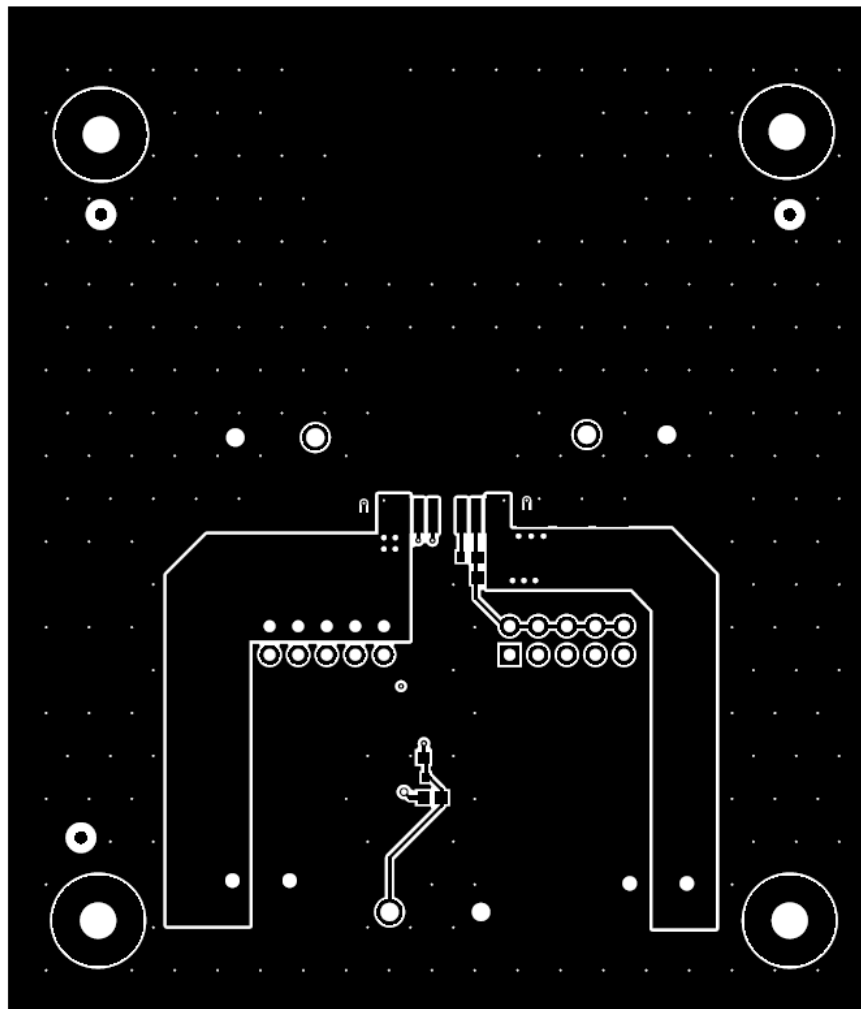

Figure 4-2. Top Copper Layer

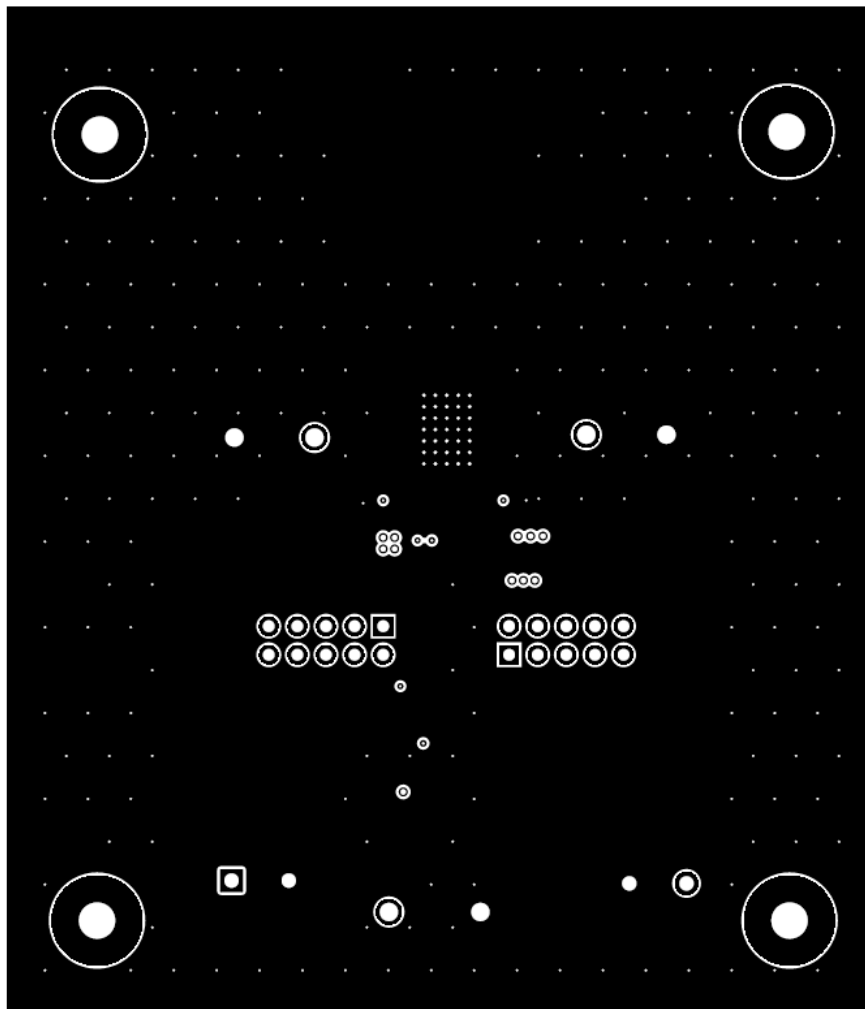

Figure 4-3. Signal Layer 1

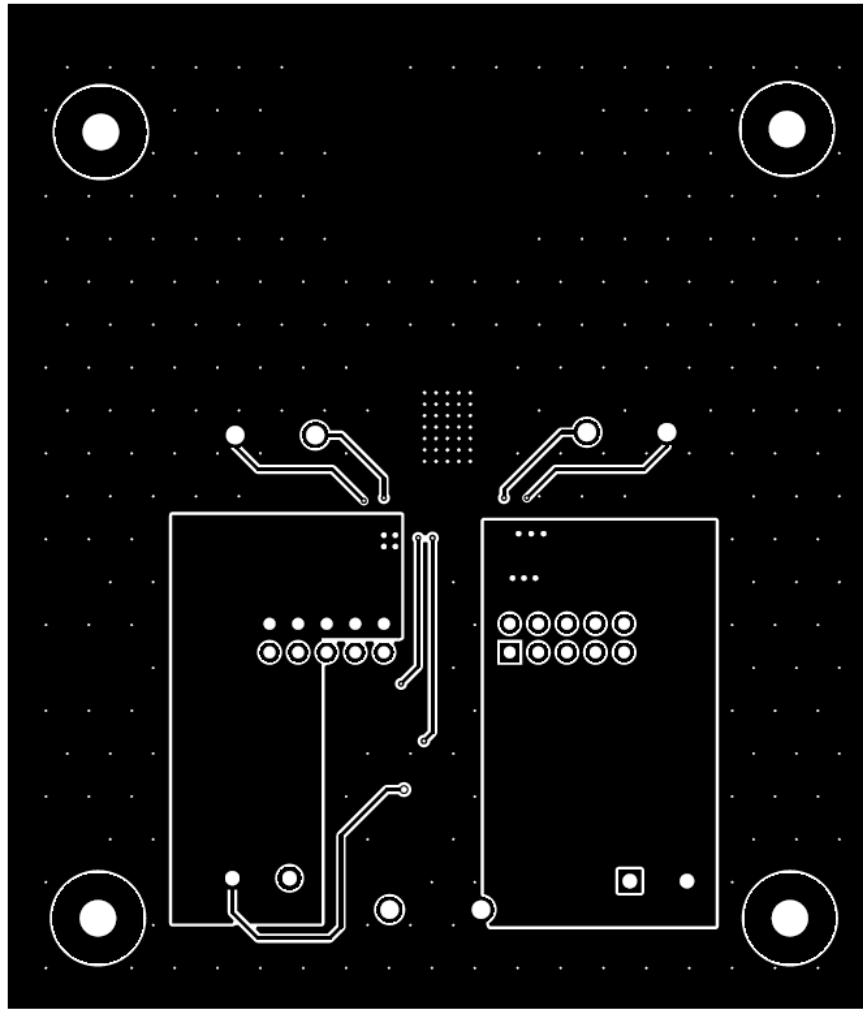

Figure 4-4. Signal Layer 2

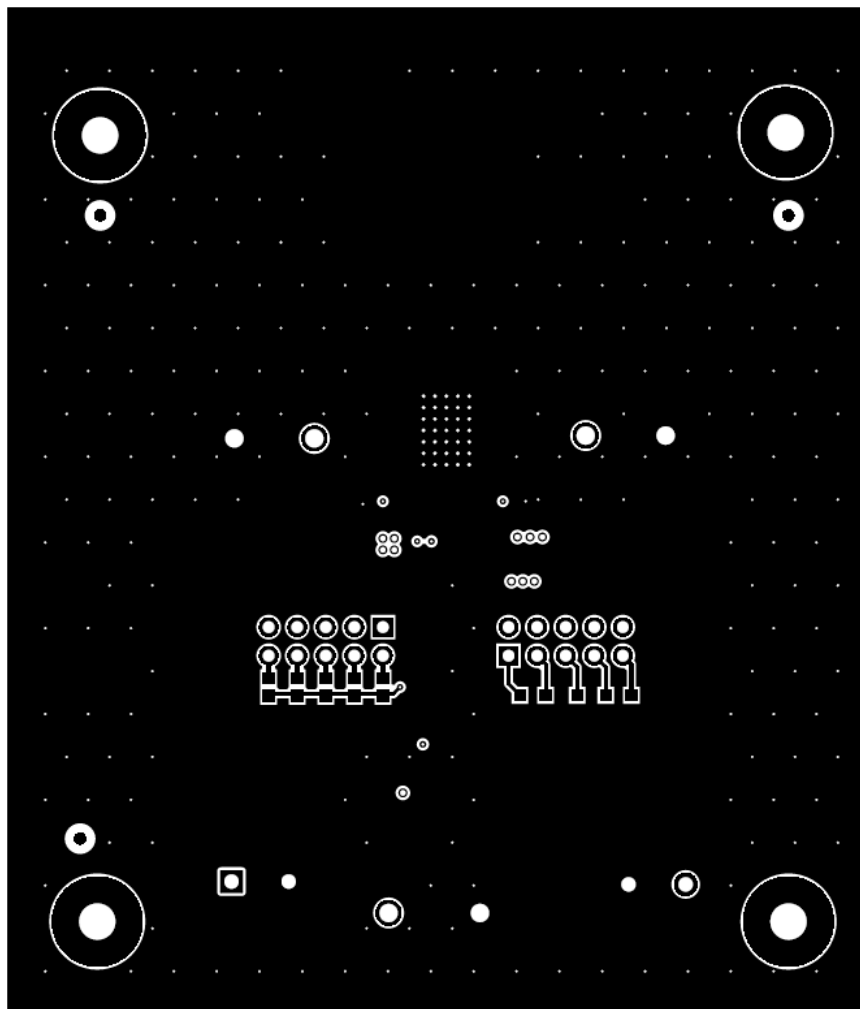

Figure 4-5. Bottom Copper Layer

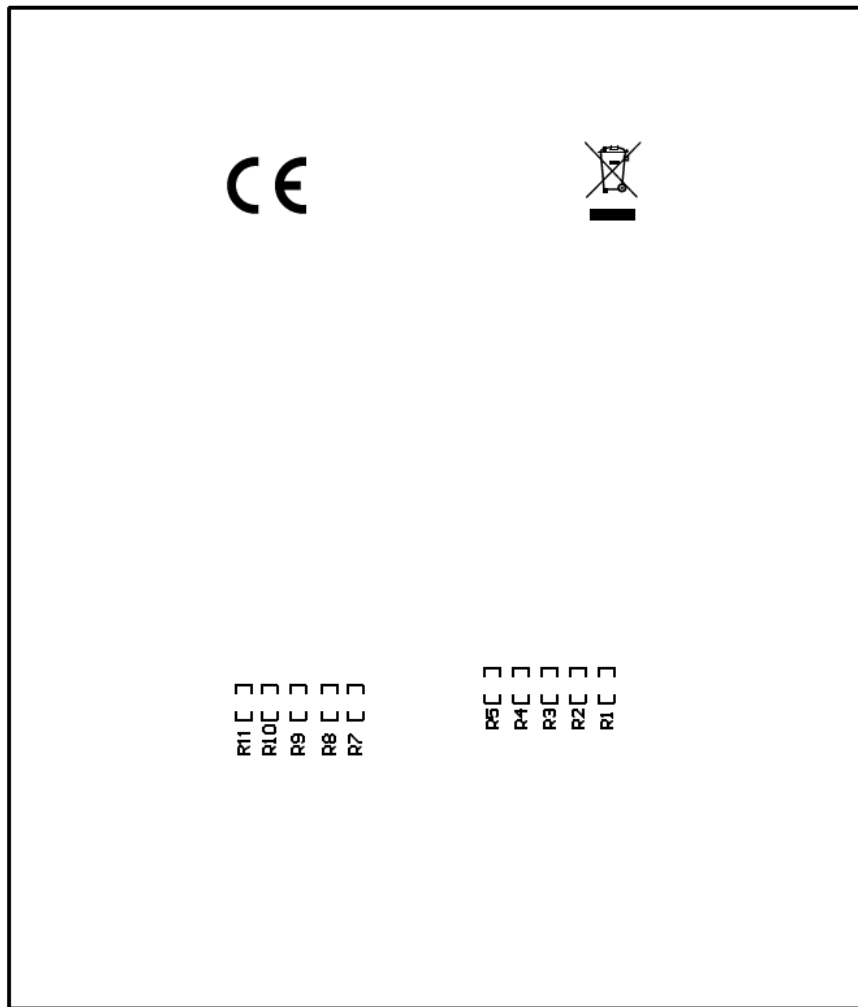

Figure 4-6. Bottom Layer Silk Screen (Bottom View)

4.2 EVM Schematic

Figure 4-7 shows the TPSM13604HEVM schematic.

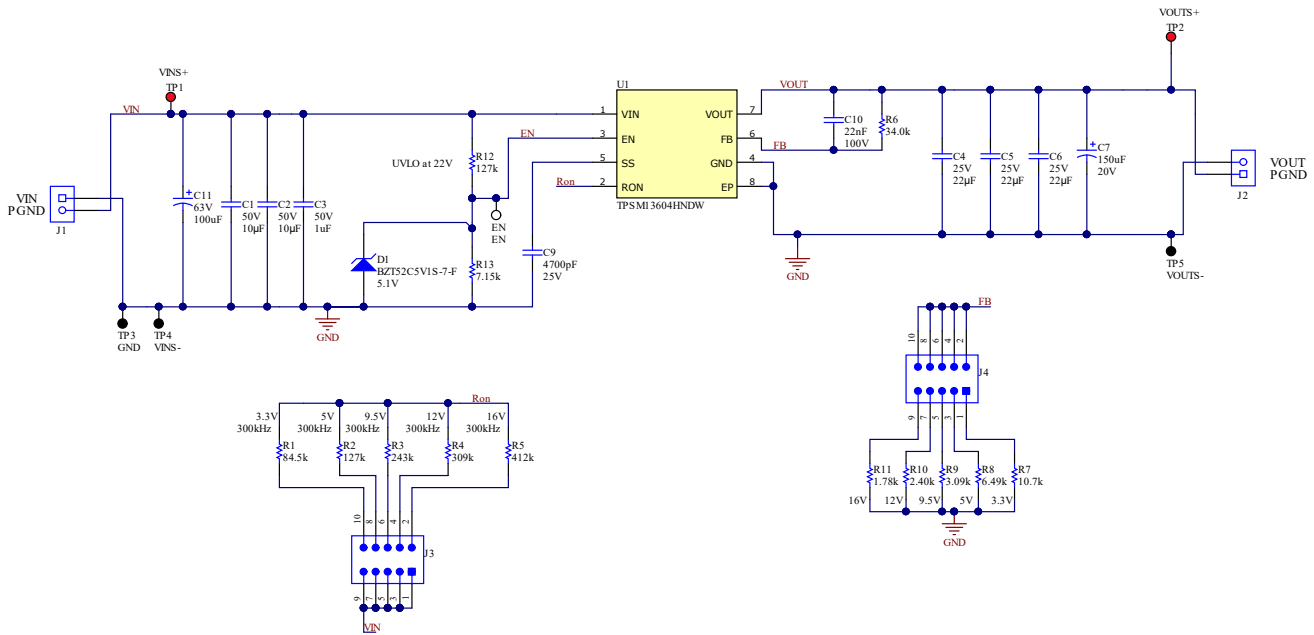

Figure 4-7. TPSM13604HEVM Schematic

4.3 Bill of Materials (BOM)

Figure 4-8 shows the TPSM13604HEVM BOM.

Designator	Quantity	Value	Description	PackageReference	PartNumber	Manufacturer	Alternate PartNumber	Alternate Manufacturer
PCB	1		Printed Circuit Board		BSR150	Any		
C1, C2	2	10uF	CAP, CERM, 10 uF, 50 V, +/- 10%, X5R, 1210	1210	CL32A106KBJNNE	Samsung Electro-Mechanics		
C3	1	1uF	CAP, CERM, 1 uF, 50 V, +/- 10%, X5R, 0805	0805	C2012X5R1H105K125A B	TDK		
C4, C5, C6	3	22uF	CAP, CERM, 22 uF, 25 V, +/- 10%, X7R, 1210	1210	CC1210KX7R88B226	Yageo		
C7	1		150uF Molded Tantalum Polymer Capacitor 20V 2917 (7343 Metric) 50mOhm @ 100kHz	2917	T521D157M020A0TE050	Kemet		
C9	1	4700pF	CAP, CERM, 4700 pF, 25 V, +/- 10%, X7R, 0402	0402	CC0402KRX7R88B472	Yageo		
C10	1	0.022uF	CAP, CERM, 0.022 uF, 100 V, +/- 10%, X7R, 0603	0603	C1608X7R2A223K080A A	TDK		
C11	1	100uF	CAP, AL, 100 uF, 63 V, +/- 20%, 0.35 ohm, AEC-Q200 Grade 2, SMD		EEE-FK1J101P	Panasonic		
D1	1	5.1V	Diode, Zener, 5.1 V, 200 mW, SOD-323	SOD-323	BZT52C5V1S-7-F	Diodes Inc.		
EN	1		Test Point, Compact, White, TH	White Compact Testpoint	5007	Keystone		
FID1, FID2, FID3, FID4, FID5, FID6	6		Fiducial mark. There is nothing to buy or mount.	N/A	N/A	N/A		
H1, H2, H3, H4	4		Machine Screw, Round, #4-40 x 1/4, Nylon, Philips panhead	Screw	NY PMS 440 0025 PH	B&F Fastener Supply		
H5, H6, H7, H8	4		Standoff, Hex, 0.5"L #4-40 Nylon	Standoff	1902C	Keystone		
J1, J2	2		Terminal Block, 5.08 mm, 2x1, Brass, TH	2x1 5.08 mm Terminal Block	ED120/2DS	On-Shore Technology		
J3, J4	2		Header, 100mil, 5x2, Tin, TH	Header, 5x2, 100mil, Tin	PEC05DAAN	Sullins Connector Solutions		
R1	1	84.5k	RES, 84.5 k, 1%, 0.1 W, 0603	0603	RC0603FR-0784K5L	Yageo		
R2, R12	2	127k	RES, 127 k, 1%, 0.1 W, 0603	0603	RC0603FR-07127KL	Yageo		
R3	1	243k	RES, 243 k, 1%, 0.1 W, 0603	0603	RC0603FR-07243KL	Yageo		
R4	1	309k	RES, 309 k, 1%, 0.1 W, 0603	0603	RC0603FR-07309KL	Yageo		
R5	1	412k	RES, 412 k, 1%, 0.1 W, 0603	0603	RC0603FR-07412KL	Yageo		
R6	1	34.0k	RES, 34.0 k, 1%, 0.1 W, 0603	0603	RC0603FR-0734KL	Yageo		
R7	1	10.7k	RES, 10.7 k, 1%, 0.1 W, 0603	0603	RC0603FR-0710K7L	Yageo		
R8	1	6.49k	RES, 6.49 k, 1%, 0.1 W, 0603	0603	RC0603FR-076K49L	Yageo		
R9	1	3.09k	RES, 3.09 k, 1%, 0.1 W, 0603	0603	RC0603FR-073K09L	Yageo		
R10	1	2.40k	RES, 2.40 k, 1%, 0.1 W, 0603	0603	RC0603FR-072K4L	Yageo		
R11	1	1.78k	RES, 1.78 k, 1%, 0.1 W, 0603	0603	RC0603FR-071K78L	Yageo		
R13	1	7.15k	RES, 7.15 k, 1%, 0.1 W, 0603	0603	RC0603FR-077K15L	Yageo		
SH-J1, SH-J2	2	1x2	Shunt, 100mil, Gold plated, Black	Shunt	SNT-100-BK-G	Samtec	969102-0000-DA	3M
TP1, TP2	2		Test Point, Compact, Red, TH	Red Compact Testpoint	5005	Keystone		
TP3, TP4, TP5	3		Test Point, Compact, Black, TH	Black Compact Testpoint	5006	Keystone		
U1	1		5V to 36V, 4A High Output Voltage Power Module	TO-PM07	TPSM13604HNDW	Texas Instruments		

Figure 4-8. TPSM13604HEVM BOM

IMPORTANT NOTICE AND DISCLAIMER

TI PROVIDES TECHNICAL AND RELIABILITY DATA (INCLUDING DATA SHEETS), DESIGN RESOURCES (INCLUDING REFERENCE DESIGNS), APPLICATION OR OTHER DESIGN ADVICE, WEB TOOLS, SAFETY INFORMATION, AND OTHER RESOURCES "AS IS" AND WITH ALL FAULTS, AND DISCLAIMS ALL WARRANTIES, EXPRESS AND IMPLIED, INCLUDING WITHOUT LIMITATION ANY IMPLIED WARRANTIES OF MERCHANTABILITY, FITNESS FOR A PARTICULAR PURPOSE OR NON-INFRINGEMENT OF THIRD PARTY INTELLECTUAL PROPERTY RIGHTS.

These resources are intended for skilled developers designing with TI products. You are solely responsible for (1) selecting the appropriate TI products for your application, (2) designing, validating and testing your application, and (3) ensuring your application meets applicable standards, and any other safety, security, regulatory or other requirements.

These resources are subject to change without notice. TI grants you permission to use these resources only for development of an application that uses the TI products described in the resource. Other reproduction and display of these resources is prohibited. No license is granted to any other TI intellectual property right or to any third party intellectual property right. TI disclaims responsibility for, and you will fully indemnify TI and its representatives against, any claims, damages, costs, losses, and liabilities arising out of your use of these resources.

TI's products are provided subject to [TI's Terms of Sale](#) or other applicable terms available either on ti.com or provided in conjunction with such TI products. TI's provision of these resources does not expand or otherwise alter TI's applicable warranties or warranty disclaimers for TI products.

TI objects to and rejects any additional or different terms you may have proposed.

Mailing Address: Texas Instruments, Post Office Box 655303, Dallas, Texas 75265
Copyright © 2022, Texas Instruments Incorporated