

Jun.1.2024 Copyright 2024 HIROSE ELECTRIC CO., LTD. All Rights Reserved.
 In case of consideration for using Automotive equipment / device which demand high reliability, kindly contact our sales window correspondents.

ELV·RoHS COMPLIANT

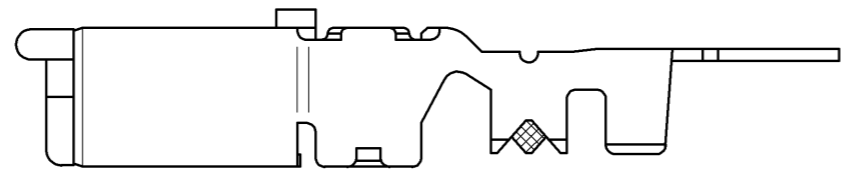
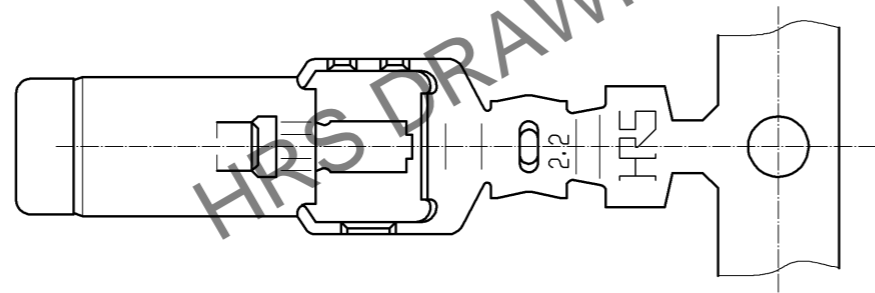
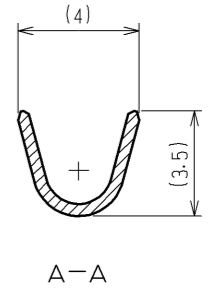
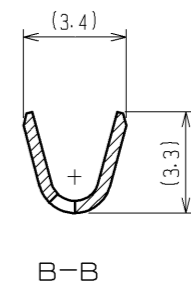
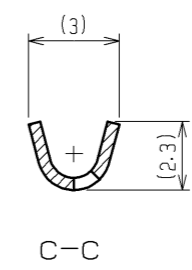
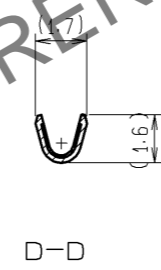
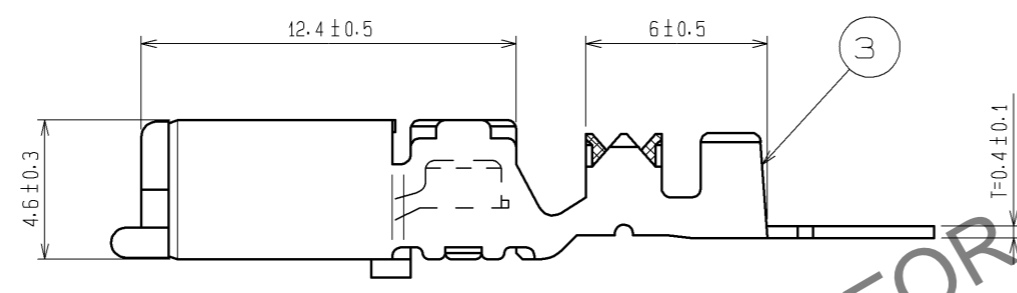
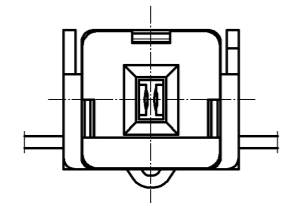
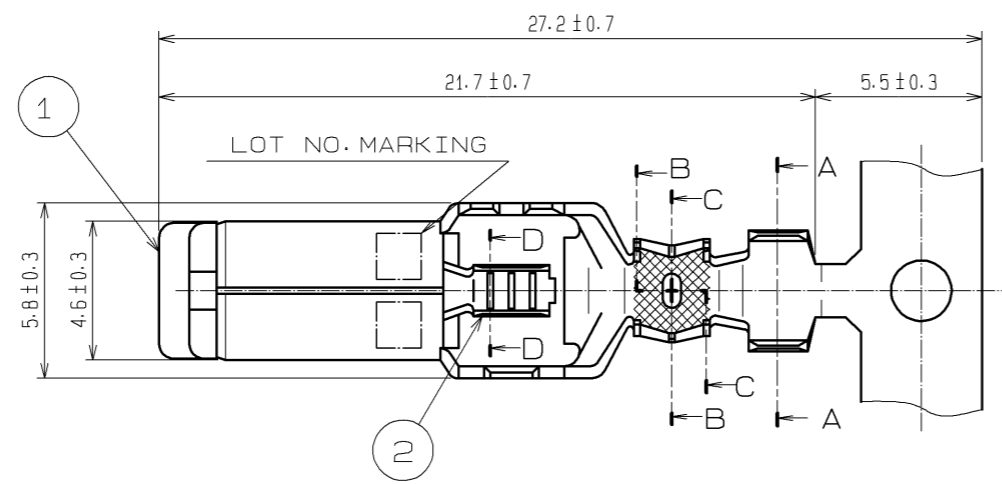

NOTE1. ONE REEL CONSISTS OF 1300 PIECES OF CONTACTS.

2	PHOSPHOR BRONZE	TIN PLATED, T=0.25					
1	PBT	UL94V-0, DARK GRAY	3	BRASS	TIN PLATED, T=0.4		
NO.	MATERIAL	FINISH, REMARKS	NO.	MATERIAL	FINISH, REMARKS		
UNITS mm		SCALE 4 : 1		DESCRIPTION OF REVISIONS	DESIGNED	CHECKED	DATE
HRS HIROSE ELECTRIC CO., LTD.		APPROVED : KS. SATOH	08.08.26	DRAWING NO.	EDC3-166792-00		
		CHECKED : MO. OKADA	08.08.26	PART NO.	GT5-2428/1.1-2.2SCF		
		DESIGNED : MH. YAMAGUCHI	08.08.26	CODE NO.	CL755-0123-6-00		
		DRAWN : MH. YAMAGUCHI	08.08.26				1/1