

HSD12

Unidirectional TVS Diode

DESCRIPTION

The HSD12 is designed for applications requiring transient overvoltage protection capability. This is intended for use in voltage and ESD sensitive equipment such as computers, printers, business machines, communication systems, medical equipment and other applications. It is ideal for situations where board space is at a premium.

The HSD12 has been specifically designed to protect sensitive components which are connected to power, data and transmission lines from overvoltage caused by ESD (electrostatic discharge), CDE (Cable Discharge Events), and EFT (electrical fast transients).

ORDERING INFORMATION

- ✧ Device: HSD12
- ✧ Package: SOD-323
- ✧ Material: Halogen free
- ✧ Packing: Tape & Reel
- ✧ Quantity per reel: 3,000pcs

PIN CONFIGURATION

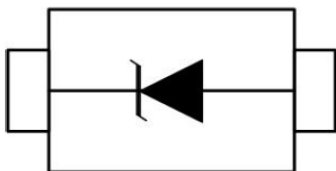

FEATURES

- ✧ IEC61000-4-2 (ESD) $\pm 30\text{kV}$ (air), $\pm 30\text{kV}$ (contact)
- ✧ IEC61000-4-4 (EFT) 40A (5/50ns)
- ✧ 350Watts PeakPulsePowerper ($t_p=8/20\mu\text{s}$)
- ✧ Protects one I/O line (unidirectional)
- ✧ Low clamping voltage
- ✧ Working voltages : 12V
- ✧ Low leakage current

MACHANICAL DATA

- ✧ SOD-323 package
- ✧ Flammability Rating: UL 94V-0
- ✧ Packaging: Tape and Reel
- ✧ High temperature soldering guaranteed: $260^\circ\text{C}/10\text{s}$
- ✧ Reel size: 7 inch

APPLICATIONS

- ✧ Cell Phone Handsets and Accessories
- ✧ Microprocessor based equipment
- ✧ Personal Digital Assistants (PDA's)
- ✧ Notebooks, Desktops, and Servers
- ✧ Portable Instrumentation
- ✧ Networking and Telecom
- ✧ Serial and Parallel Ports
- ✧ Peripherals

PACKAGE OUTLINE



HSD12

Unidirectional TVS Diode

ABSOLUTE MAXIMUM RATING (Tamb=25°C)

Symbol	Parameter	Value	Units
V _{ESD}	ESD per IEC 61000-4-2 (Air)	±30	kV
	ESD per IEC 61000-4-2 (Contact)	±30	
P _{PP}	Peak Pulse Power (8/20μs)	350	W
T _{OPT}	Operating Temperature	-55/+150	°C
T _{STG}	Storage Temperature	-55/+150	°C
T _L	Lead Soldering Temperature	260 (10 sec.)	°C

ELECTRICAL CHARACTERISTICS (Tamb=25°C)

PART NUMBER	DEVICE MARKING	V _{RWM}	V _B	I _T	V _{C@1A}	V _{C @ I_{PP}}		I _R	C _J
		(V) (max.)	(V) (min.)	(mA)	(V) (max.)	(V) (max.)	(A)	(μA) (max.)	(pF) (max.)
HSD12	12W	12	13.3	1	19	32	11	1	130

HSD12

Unidirectional TVS Diode

ELECTRICAL CHARACTERISTICS CURVE

Non-Repetitive Peak Pulse Power vs. Pulse Time

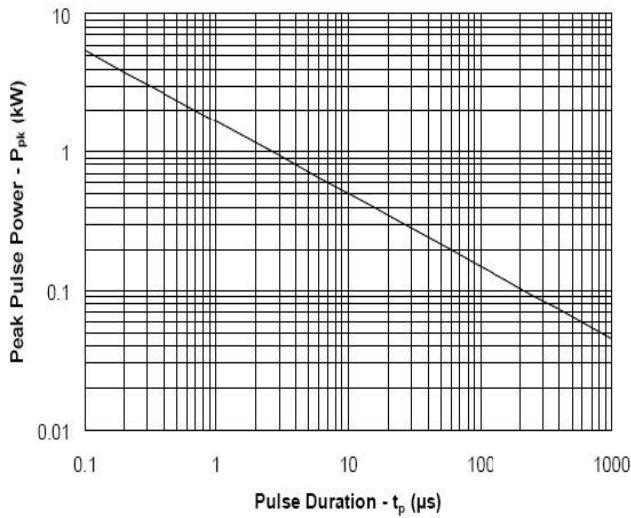

Power Derating Curve

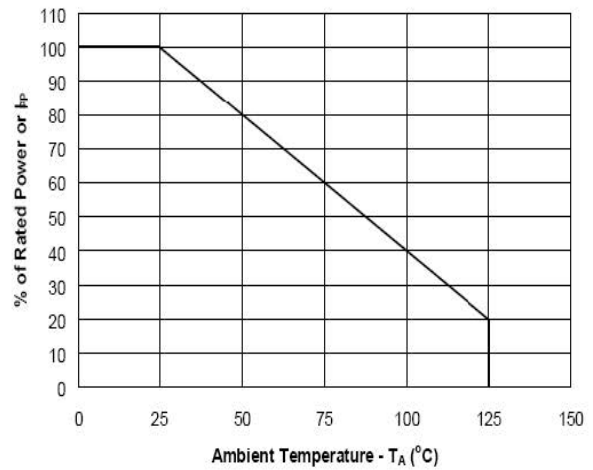

Pulse Waveform

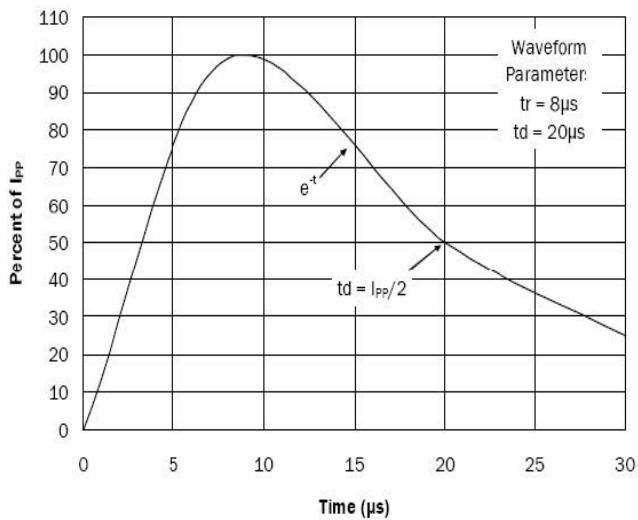

Clamping Voltage vs. Peak Pulse Current

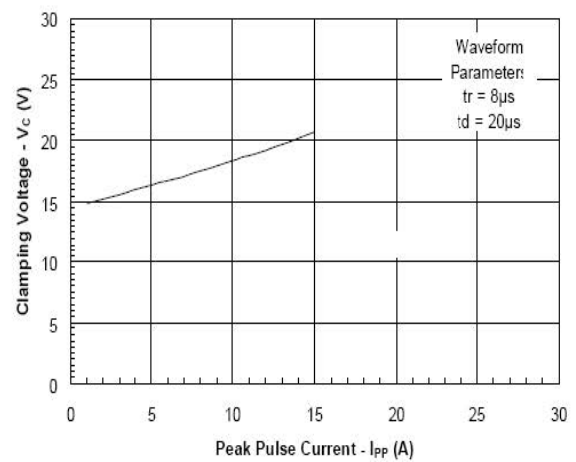

HSD12

Unidirectional TVS Diode

SOD-323 PACKAGE OUTLINE DIMENSIONS

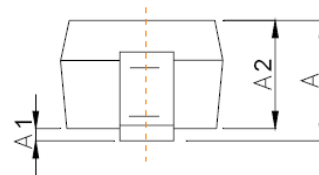
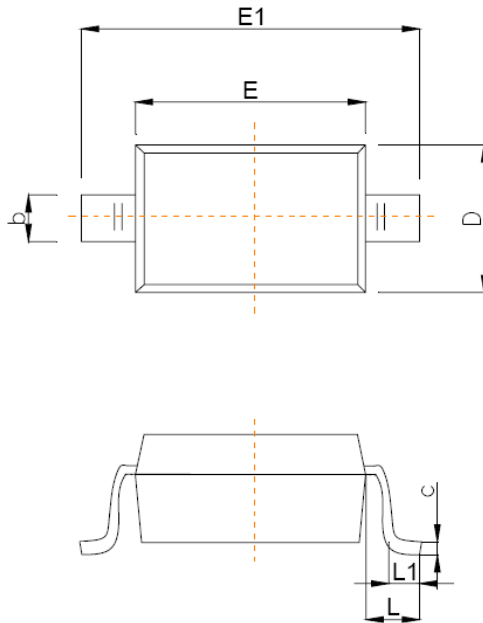

Symbol	Dimensions In Millimeters	
	Min	Max
A		1.00
A1	0.000	0.100
A2	0.800	0.900
b	0.250	0.350
c	0.080	0.150
D	1.200	1.400
E	1.600	1.800
E1	2.500	2.700
e	1.800	2.040
L	0.475 REF	
L1	0.250	0.400
θ	0°	8°

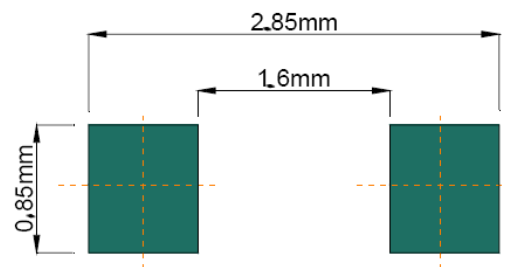

Recommended Pad outline