

41900 ✓ ACTIVE

AMPLIVAR

TE Internal #: 41900

Thru Splice, 15.5 – 12 AWG Wire Size, 1.54 – 3.46 mm<sup>2</sup> Wire Size,  
Splice Capacity 3, Serrated, AMPLIVAR, Splices

[View on TE.com >](#)



Terminals & Splices > Splices

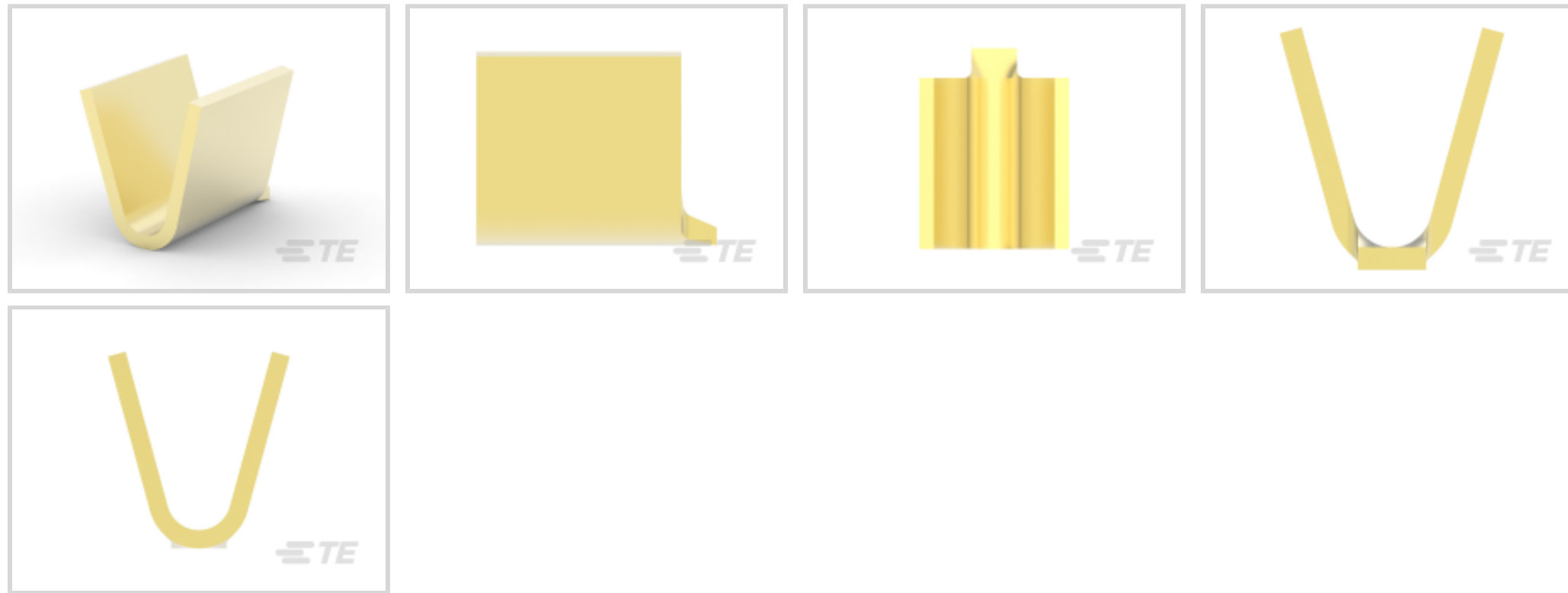

Splice Type: Thru Splice

Wire Size: 1.54 – 3.46 mm<sup>2</sup>

Sealable: No

Splice Capacity: 3

### Features

#### Product Type Features

Splice Type	Thru Splice
Sealable	No
Compatible With Discrete Wire Type	Magnet Wire, Solid

#### Configuration Features

Strip Orientation	End Feed
Splice Capacity	3
Number of Serrations	5

#### Electrical Characteristics

Operating Voltage	250 V
-------------------	-------

#### Body Features

Product Weight	.249 g
Splice Features	Serrated

#### Contact Features

Terminal Plating Material	Tin
Contact Base Material	Brass

Barrel Type	Open
-------------	------

### Termination Features

Crimp Width	3.56 mm[.14 in]
-------------	-----------------

### Mechanical Attachment

Wire Insulation Support	Without
-------------------------	---------

### Dimensions

Wire Size	3000 – 7000 CMA
-----------	-----------------

Barrel Inside Diameter	1.77 mm[.07 in]
------------------------	-----------------

Terminal Material Thickness	.51 mm[.02 in]
-----------------------------	----------------

Product Length	5.72 mm[.225 in]
----------------	------------------

### Usage Conditions

Insulation Option	Uninsulated
-------------------	-------------

Operating Temperature Range	-65 – 150 °C[-85 – 302 °F]
-----------------------------	----------------------------

### Operation/Application

Compatible With Wire Base Material	Copper
------------------------------------	--------

### Industry Standards

Government Qualified Splice	No
-----------------------------	----

### Packaging Features

Packaging Quantity	20000
--------------------	-------

Packaging Method	Strip
------------------	-------

### Product Compliance

[For compliance documentation, visit the product page on TE.com>](#)

EU RoHS Directive 2011/65/EU	Compliant
------------------------------	-----------

EU ELV Directive 2000/53/EC	Compliant
-----------------------------	-----------

China RoHS 2 Directive MIIT Order No 32, 2016	No Restricted Materials Above Threshold
---	---

EU REACH Regulation (EC) No. 1907/2006	Current ECHA Candidate List: JUNE 2024 (241) Candidate List Declared Against: JUNE 2024 (241) Does not contain REACH SVHC
--	---

Halogen Content	Low Halogen - Br, Cl, F, I < 900 ppm per homogenous material. Also BFR/CFR/PVC Free
-----------------	---

Solder Process Capability

Not applicable for solder process capability

Product Compliance Disclaimer

This information is provided based on reasonable inquiry of our suppliers and represents our current actual knowledge based on the information they provided. This information is subject to change. The part numbers that TE has identified as EU RoHS compliant have a maximum concentration of 0.1% by weight in homogenous materials for lead, hexavalent chromium, mercury, PBB, PBDE, DBP, BBP, DEHP, DIBP, and 0.01% for cadmium, or qualify for an exemption to these limits as defined in the Annexes of Directive 2011/65/EU (RoHS2). Finished electrical and electronic equipment products will be CE marked as required by Directive 2011/65/EU. Components may not be CE marked. Additionally, the part numbers that TE has identified as EU ELV compliant have a maximum concentration of 0.1% by weight in homogenous materials for lead, hexavalent chromium, and mercury, and 0.01% for cadmium, or qualify for an exemption to these limits as defined in the Annexes of Directive 2000/53/EC (ELV). Regarding the REACH Regulation, the information TE provides on SVHC in articles for this part number is based on the latest European Chemicals Agency (ECHA) 'Guidance on requirements for substances in articles' posted at this URL: <https://echa.europa.eu/guidance-documents/guidance-on-reach>

## Compatible Parts



TE Part # 63562-1  
SPLICE 10400-22900 030TPBR



TE Part # 140837-2  
SPLICE AMPLIVAR



TE Part # 1855567-1  
HDM/FA SAPR.140F G/LM CUT  
PIGTAIL SPLICE



TE Part # 2150233-2  
OCEAN-2.0-APPLICATOR-E-140F-SEA



TE Part # 2335350-1  
SYSTEM, INVERTED SPLICE



TE Part # 2335350-2  
SYSTEM, INVERTED SPLICE



TE Part # 2335350-3  
SYSTEM, INVERTED SPLICE



TE Part # 7-2150233-7  
OCEAN\_2.0\_SPARE\_PART\_KIT-140F

## Also in the Series | AMPLIVAR



Crimp Wire Pins, Tabs & Ferrules(5)



Magnet Wire Terminals(4)



PCB Terminals(1)



Quick Disconnects(40)



Ring Terminals(28)



Splices(76)

## Customers Also Bought



TE Part #1-487545-7  
020 HOUSING FFC RCPT 050CL SR

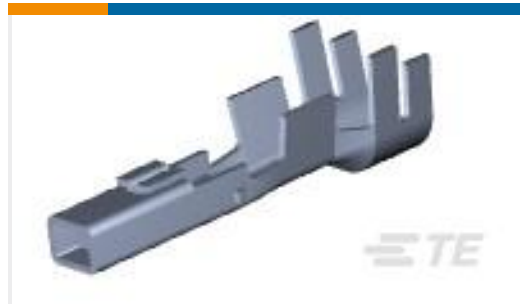

TE Part #177915-2  
AMP POWER DBL LOCK REC

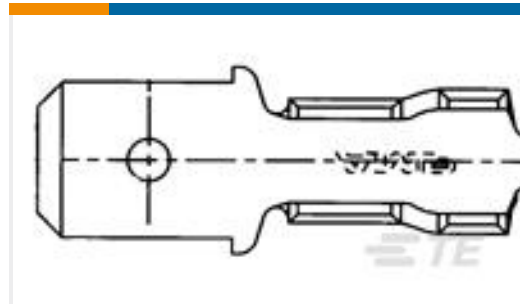

TE Part #41412  
FASTON 250(6.3MM) TAB 18-14 AWG TPBR



TE Part #60960-3  
250 FASTON FLAG REC 12-10 AWG TPBR

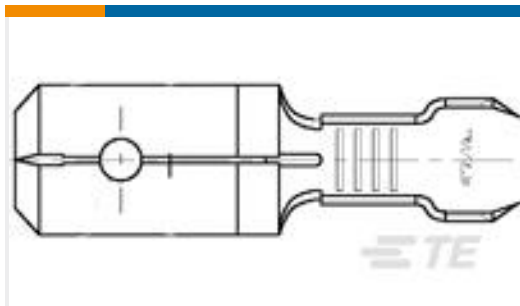

TE Part #61281-3  
250 FASTON TAB 14-12 AWG TPBR



TE Part #42100-2  
FF 250 REC 18-14AWG TPBR

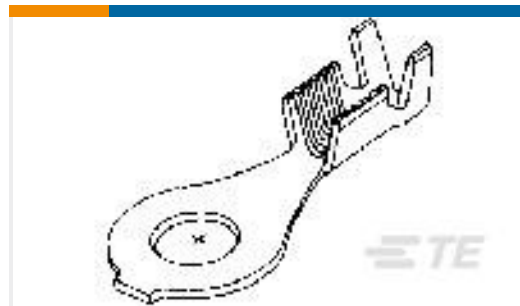

TE Part #63399-1  
AMPLIVAR RING 22-29 10 TPBR



TE Part #160913-2  
FF 250 REC 2.5-4.0MM2 TPBR

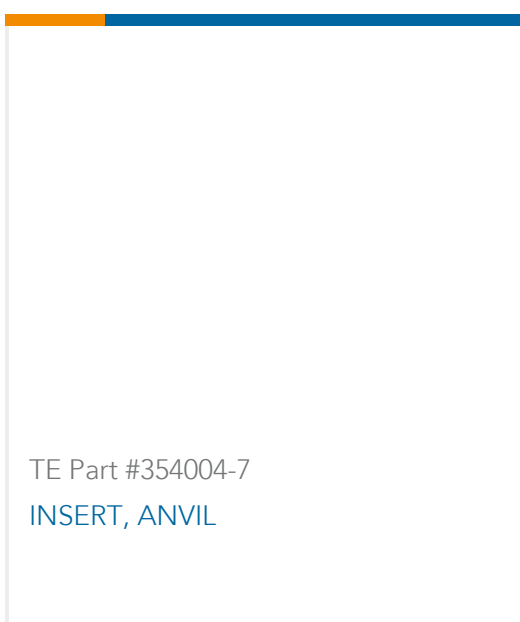

TE Part #354004-7  
INSERT, ANVIL

## Documents

### Product Drawings

[SPLC AMVAR 3000-7000 020TPBR](#)

English

### CAD Files

[3D PDF](#)

[3D](#)

[Customer View Model](#)

[ENG\\_CVM\\_CVM\\_41900\\_S\\_c-41900-s.2d\\_dxf.zip](#)



English

**Customer View Model**

[ENG\\_CVM\\_CVM\\_41900\\_S\\_c-41900-s.3d\\_igs.zip](#)

English

**Customer View Model**

[ENG\\_CVM\\_CVM\\_41900\\_S\\_c-41900-s.3d\\_stp.zip](#)

English

By downloading the CAD file I accept and agree to the [Terms and Conditions](#) of use.

---

### Datasheets & Catalog Pages

[1654742\\_HOUSEHOLD\\_APPLIANCES\\_RAST5](#)

English

**Magnet Wire Terminals & Splices**

English

---

### Product Specifications

**Application Specification**

English

**AMPLIVAR 5 Serration Thru Splice**

English

**No title**

Japanese

**Application Specification**

Japanese

**No title**

English

**Application Specification**

English