



## REGISTRATION SENSORS

Contrast, color, luminescence, glare, fork, register, array and markless sensors

**SICK**  
Sensor Intelligence.

## REGISTER AT WWW.SICK.COM TODAY AND ENJOY ALL THE BENEFITS





- ✔ Select products, accessories, documentation and software quickly and easily.
- ✔ Create, save and share personalized wish lists.
- ✔ View the net price and date of delivery for every product.
- ✔ Requests for quotation, ordering and delivery tracking made easy.
- ✔ Overview of all quotations and orders.
- ✔ Direct ordering: submit even very complex orders in moments.
- ✔ View the status of quotations and orders at any time. Receive e-mail notifications of status changes.
- ✔ Easily repeat previous orders.
- ✔ Conveniently export quotations and orders to work with your systems.



## SERVICES FOR MACHINES AND SYSTEMS: SICK LifeTime Services

Our comprehensive and versatile LifeTime Services are the perfect addition to the comprehensive range of products from SICK. The services range from product-independent consulting to traditional product services.



- 
**Consulting and design**  
 Safe and professional
- 
**Product and system support**  
 Reliable, fast and on-site
- 
**Verification and optimization**  
 Safe and regularly inspected
- 
**Upgrade and retrofits**  
 Easy, safe, economical
- 
**Training and education**  
 Practical, focused and professional

A  
B  
C  
D  
E  
F  
G  
H  
I  
J  
K  
L

CONTRAST SENSORS



COLOR SENSORS



LUMINESCENCE SENSORS



GLARE SENSORS



FORK SENSORS



REGISTER SENSORS



ARRAY SENSORS



MARKLESS SENSORS



FORK SENSORS

Combine sender and receiver in one housing: for accurate object and label detection. → Chapter F

GLARE SENSORS

Detect and distinguish between different gloss levels. → Chapter E

LUMINESCENCE SENSORS

Detect luminescent marks that are invisible to the human eye. → Chapter D

COLOR SENSORS

Identify, inspect, and sort by color. → Chapter C

CONTRAST SENSORS

Detect weak contrasts, even at very high speeds. → Chapter B

A WIDE VARIETY

The details of process control are often invisible to the human eye. Different marks such as colors, contrasts, or gloss – as well as invisible substances or entire patterns – race past, escaping detection.

But nothing escapes SICK's intelligent registration sensors – with a wide-ranging portfolio, they ensure the safe and reliable detection of various optical features.

REGISTER SENSORS

Detect control marks for register control quickly and precisely. → Chapter G

ARRAY SENSORS











Detect edges, lines, and diameters with a high level of accuracy. → Chapter H

MARKLESS SENSORS

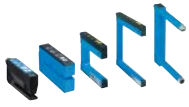
Control the cutting process based on repeating patterns – without any marks. → Chapter I

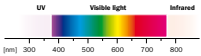

Unlimited Detection We simply detect any object.

	<b>GENERAL INFORMATION</b> About SICK	<b>A</b>
	<b>CONTRAST SENSORS</b> KTM Core, KTM Prime, KT3L Laser, KT5, KTL5-2 Fiber Optic, KT6-2, KT8, KT10-2	<b>B</b>
	<b>COLOR SENSORS</b> CSM, CS8	<b>C</b>
	<b>LUMINESCENCE SENSORS</b> LUTM, LUT3-6, LUT8, LUT9	<b>D</b>
	<b>GLARE SENSORS</b> Glare	<b>E</b>
	<b>FORK SENSORS</b> WFS, UFnex, WFnext, WFL, WFM	<b>F</b>
	<b>REGISTER SENSORS</b> RS10, RS25	<b>G</b>
	<b>ARRAY SENSORS</b> Ax20	<b>H</b>
	<b>MARKLESS SENSORS</b> ML20	<b>I</b>
	<b>SMART SENSOR SOLUTIONS</b>	<b>J</b>
	<b>ACCESSORIES</b>	<b>K</b>
	<b>APPENDIX</b> Glossary, Index	<b>L</b>



## A WE DELIVER “SENSOR INTELLIGENCE.”

SICK sensor solutions for industrial automation are the result of exceptional dedication and experience. From development all the way to service: The people at SICK are committed to investing all their expertise in providing with the very best sensors and system solutions possible.

### A company with a culture of success

Almost 7,000 people are on staff, with products and services available to help SICK sensor technology users increase their productivity and reduce their costs. Founded in 1946 and headquartered in Waldkirch, Germany, SICK is a global sensor specialist with more than 50 subsidiaries and representations worldwide. The people work with pleasure at SICK.

This is demonstrated by the accolades that the company is regularly awarded in the “Great Place to Work” competition. This lively corporate culture holds strong appeal for qualified and skilled persons. In SICK, they are part of a company that ensures an excellent balance between career progression and quality of life.



## Innovation for the leading edge

SICK sensor systems simplify and optimize processes and allow for sustainable production. SICK operates at many research and development centers all over the world. Co-designed with customers and universities, our innovative sensor products and solutions are made to give a decisive edge. With an impressive track record of innovation, we take the key parameters of modern production to new levels: reliable process control, safety of people and environmental protection.

## A corporate culture for sustainable excellence

SICK is backed by a holistic, homogeneous corporate culture. We are an independent company. And our sensor technology is open to all system environments. The power of innovation has made SICK one of the technology and market leaders – sensor technology that is successful in the long term.





# A “SENSOR INTELLIGENCE.” FOR ALL REQUIREMENTS

SICK is a renowned expert in many industries, and is entirely familiar with the critical challenges they face. While speed, accuracy and availability take center stage in all industries, technical implementations vary greatly. SICK puts its vast experience to use to provide with precisely the solution you need.

## For applications worldwide

Hundreds of thousands of installations and applications go to prove that SICK knows the different industries and their processes inside out. This tradition of uncompromising expertise is ongoing: As we move into the future, we will continue

to design, implement and optimize customized solutions in our application centers in Europe, Asia and North America. You can count on SICK as a reliable supplier and development partner.





### For your specific industry

With a track record of proven expertise in a great variety of industries, SICK has taken quality and productivity to new heights. The automotive, pharmaceutical, electronics and solar industries are just a few examples of sectors that benefit from our know-how. In addition to increasing speed and improving traceability in warehouses and distribution centers, SICK solutions provide accident protection for automated guided vehicles. SICK system solutions for analysis and flow measurement of gases and liquids enable environmental protection and sustainability in, for example, energy production, cement production or waste incineration plants.

### For performance across the board

SICK provides the right technology to respond to the tasks involved in industrial automation: measuring, detecting, monitoring and controlling, protecting, networking and integrating, identifying, positioning. Our development and industry experts continually create groundbreaking innovations to solve these tasks.

→ [www.sick.com/industries](http://www.sick.com/industries)





## A SERVICES FOR MACHINES AND SYSTEMS: SICK LifeTime Services

SICK LifeTime Services is a comprehensive set of high-quality services provided to support the entire life cycle of products and applications from plant walk-through to upgrades. These services increase the safety of people, boost the productivity of machines and serve as the basis for our customers' sustainable business success. LifeTime Services range from product-independent consulting to traditional product services and are characterized by extensive industry expertise and more than 60 years of experience.





→ [www.sick.com/service](http://www.sick.com/service)



### Consulting and design

- Plant walk-through
- Risk assessment
- Safety concept
- Safety software and hardware design
- Validation of functional safety
- CE-conformance check



### Product and system support

- Installation
- Commissioning
- Start-up support
- Calibrations
- Telephone support
- 24-hour helpline
- SICK Remote Service
- Troubleshooting on site
- Repairs
- Exchange units
- Extended warranty



### Verification and optimization

- Inspection
- Stop time measurement
- Machine safety inspection
- Electrical equipment check
- Accident investigation
- Initial verification
- Performance check
- Maintenance



### Upgrade and retrofits

- Upgrade services



### Training and education

- Training
- Seminars
- Web training



# A VERSATILE PRODUCT RANGE FOR INDUSTRIAL AUTOMATION

From the simple acquisition task to the key sensor technology in a complex production process: With every product from its broad portfolio, SICK offers a sensor solution that best combines cost effectiveness and safety.

[→ www.sick.com/products](http://www.sick.com/products)

## Photoelectric sensors

- MultiTask photoelectric sensors
- Miniature photoelectric sensors
- Small photoelectric sensors
- Compact photoelectric sensors
- Cylindrical photoelectric sensors
- Fiber-optic sensors and fibers



## Proximity sensors

- Inductive proximity sensors
- Capacitive proximity sensors
- Magnetic proximity sensors

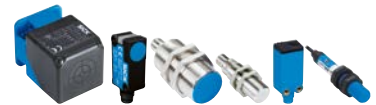

## Magnetic cylinder sensors

- Analog positioning sensors
- Sensors for T-slot cylinders
- Sensors for C-slot cylinders
- Sensor adapters for other cylinder types



## Registration sensors

- Contrast sensors
- Markless sensors
- Color sensors
- Luminescence sensors
- Fork sensors
- Array sensors
- Register sensors



## Automation light grids

- Measuring automation light grids
- Switching automation light grids





### Opto-electronic protective devices

- Safety laser scanners
- Safety light curtains
- Safety camera systems
- Multiple light beam safety devices
- Single-beam photoelectric safety switches
- Mirror columns and device columns



### Safety switches

- Electro-mechanical safety switches
- Non-contact safety switches
- Safety command devices



### sens:Control – safe control solutions

- Safety controllers
- Safe sensor cascade
- Safety relays



### Gas analyzers

- Gas transmitters
- In-situ gas analyzers
- Extractive gas analyzers



### Dust measuring devices

- Scattered light dust measuring devices
- Transmittance dust measuring devices
- Gravimetric dust measuring devices



### Analyzer solutions

- CEMS solutions
- Process solutions





# A

## Traffic sensors

- Tunnel sensors
- Overheight detectors
- Visual range measuring devices



## Ultrasonic gas flow measuring devices

- Volume flow measuring devices
- Mass flow measuring devices
- Flow velocity measuring devices
- Gas flow meters
- Flow computers



## Motor feedback systems

- Motor feedback system rotary HIPERFACE®
- Motor feedback system rotary HIPERFACE DSL®
- Motor feedback system rotary incremental
- Motor feedback system rotary incremental with commutation
- Motor feedback system linear HIPERFACE®



## Encoders

- Absolute encoders
- Incremental encoders
- Linear encoders
- Wire draw encoders
- Safety encoders



## Identification solutions

- Bar code scanners
- Image-based code readers
- Hand-held scanners
- RFID



Vision

- Vision sensors
- Smart cameras
- High-end cameras



Distance sensors

- Short range distance sensors (displacement)
- Mid range distance sensors
- Long range distance sensors
- Linear measurement sensors
- Ultrasonic sensors
- Double sheet detection
- Optical data transmission
- Position finders



Detection and ranging solutions

- 2D laser scanners
- 3D laser scanners



Fluid sensors

- Level sensors
- Pressure sensors
- Flow sensors
- Temperature sensors



System solutions

- Customized analyzer systems
- Collision awareness systems
- Flexible automation systems
- Object detection systems
- Profiling systems
- Quality control systems
- Security systems
- Track and trace systems



B



## CONTRAST SENSORS



### SICK – The pioneer in contrast sensors for more than 60 years









Contrast sensors are primarily used in packaging or printing machines to recognize brands. They can also be used in any application that is based on a distinction between differences in contrast. SICK's line of KT contrast sensors detects even the smallest contrasts at the highest speeds, such as print marks on foils or packaging. They detect minute grayscale variations between the mark and the background on matte, shiny or transparent surfaces. A variety of device

types with different contrast resolution methods and teach-in versions are available to meet wide-ranging requirements.

#### Your benefits

- Able to process all packaging materials (yellow mark/white background), resulting in high machine throughput
- Reliable operation, even with jittering webs and high-gloss materials
- High positioning accuracy improves packaging quality
- Simple teach-in and highly visible light spot ensure easy setup
- Simple to integrate into machines due to compact design
- Interchangeable lenses for maximum mounting flexibility
- A range of sensing distances, light spot directions and a 90° rotatable plug enables optimal integration
- Application-specific teach-in processes provide maximum flexibility



<b>General information</b> . . . . .		<b>B-16</b>	
<b>Product family overview</b> . . . . .		<b>B-20</b>	
	<b>KTM Core</b> . . . . . <b>B-24</b> Mini, easy, speedy		<b>KTL5-2 Fiber Optic</b> . . . . . <b>B-58</b> Contrast sensors with fiber-optic cables
	<b>KTM Prime</b> . . . . . <b>B-30</b> Mini, easy, speedy, robust		<b>KT6-2</b> . . . . . <b>B-66</b> Easy contrast detection
	<b>KT3L Laser</b> . . . . . <b>B-38</b> Long sensing distance – precise detection		<b>KT8.</b> . . . . . <b>B-72</b> Laser contrast sensor and CAN communication
	<b>KT5.</b> . . . . . <b>B-44</b> Contrast sensor in standard metal housing		<b>KT10-2.</b> . . . . . <b>B-80</b> The industry choice for high-speed and precision mark detection



# B

## A CLEAR DISTINCTION FOR ALL CONTRASTS

It is not always easy to detect subtle differences. Only those with a marked instinct for details will notice fine nuances and deviations. If this level of sensitivity is required, then SICK contrast sensors are what you need.

When controlling packaging processes, sensors must detect print marks quickly and precisely. And if the grayscale differences between the mark and the background are extremely weak, SICK contrast sensors are the ideal solution.

Wherever print marks are used to trigger a switching signal – whether on paper, glossy foil, or other packaging materials – contrast sensors can be used. With over 50 years of experience, SICK is a deserved market leader in this field.



# SHOWING MARKS IN THEIR TRUE LIGHT

SICK contrast sensors detect minimum contrast levels at maximum speeds, for example print marks on foil or packaging. Based on the reflection principle, they detect even weak grayscale variations between the mark and the background on matte, shiny, or transparent surfaces.

B



**KTM Core  
KTM Prime**

**Small and compact**

- Universal application thanks to 3-color LED technology
- Simple teach-in for setting transmission color, switching point, and gloss adjustment
- Extremely compact housing takes up little space
- Stainless-steel housing available

**Particularly suitable for**

- Space restrictions
- High speeds



**KT5-2 Display**

**Robust and flexible**

- Bar graph for visualizing the contrast quality
- Variability via different sensing distances and light spots
- Robust, multifunctional housing

**Particularly suitable for**

- Uses in the packing industry
- Highly variable contrast conditions



**KT10-2**

**Quick and precise**

- Very accurate detection at high production speeds
- Permanent display of detection quality

**Particularly suitable for**

- Use in the print and paper industry
- High speeds
- Minute contrasts
- Glossy materials



**KT3L Laser  
KT8L Laser**

**Distant and accurate**

- Laser technology
- Large detection distance and small, precise light spot

**Particularly suitable for**

- Tiny marks, for example bar codes
- Large operating detection distances of up to 600 mm

## TECHNOLOGY

Print marks on product packaging are indispensable in production processes. To detect a wide variety of print marks, SICK offers contrast sensors with a range of different technologies.

### B

#### Teach-in

Once a mark is detected, sensor teach-in is very simple. Depending on the field of application, teach-in can be triggered in various ways.

##### Dynamic teach-in

- Teach-in during operation
- No interruption of material flow
- Teach-in can also be triggered via an external control cable

##### Static 2-point teach-in

- Extremely simple teach-in when machine is stopped

##### Manual adjustment via potentiometer

- Very precise adjustment when machine is stopped

The different teach-in options assist the operator in configuring the contrast sensor teach-in, even under the toughest installation conditions, to ensure trouble-free operation.



#### 3-color LED technology

##### Maximum detection reliability

- During teach-in, the sensor sends three different light sources (red, green, and blue) to the object to be detected, and then selects the emitted light that will achieve the highest contrast value
- This allows the contrast sensors to detect all color combinations, even finely resolving combinations such as yellow on white. Therefore, the sensor can be used everywhere.



Black marks on high-gloss target



Colored marks on patterned background

#### White LED technology

##### Neutral white emitted light is suitable for

- Detecting different marks with one setting
- Reading colored codes
- Reliable detection when there is printing on the background between marks, e.g. tubes

Small black marks on white background



OMR marks on paper

Light marks on a dark background



Colored pharma bar code



## TYPICAL APPLICATIONS

### Detecting print marks

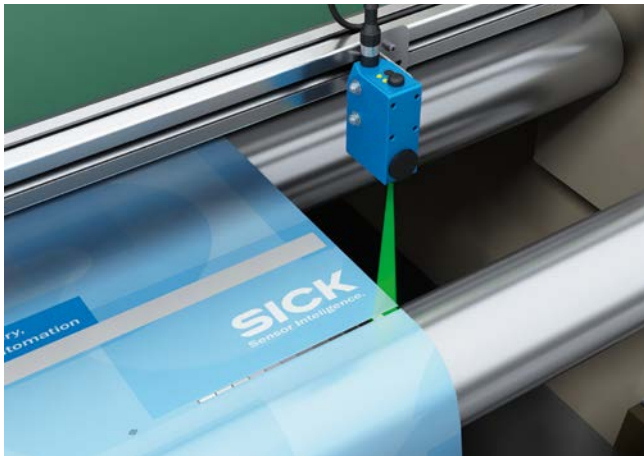

Detection of print marks for precise controlling of packaging processes on horizontal and vertical filling and sealing machines, labeling and filling plants. SICK contrast sensors detect these marks reliably and with precision.

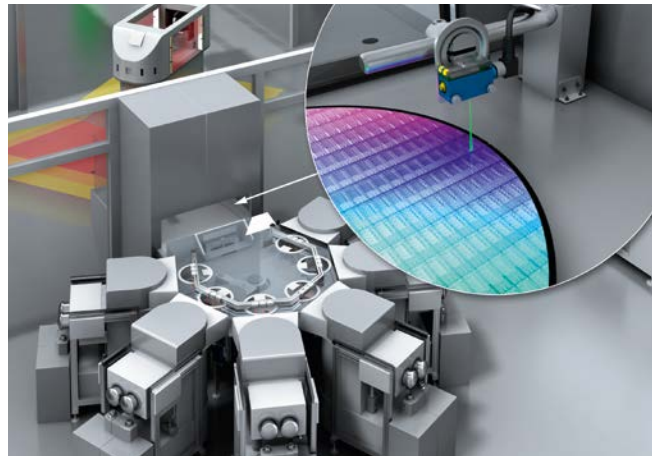

Contrasts do not just appear on packaging materials. As well as detecting marks, SICK contrast sensors demonstrate their reliability by distinguishing between surface characteristics. For example, wafers have different, sometimes highly glossy surfaces depending on the layer. During wafer production, these surfaces must be positioned properly to ensure that the correct side of the wafer is processed further. The high-performance contrast sensors reliably detect the different surface coatings on the various sides of the wafer – without any complex teach-in.

B

## WIDE PRODUCT PORTFOLIO

SICK contrast sensors have an impressive range of options, offering the right solution for almost any challenge.

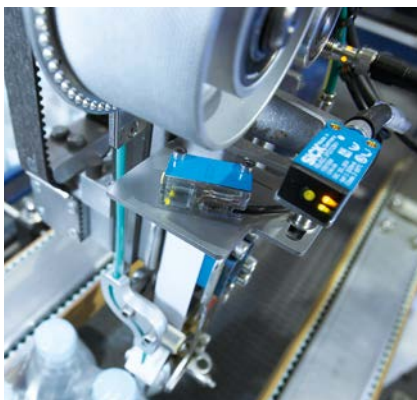

Their small housing means they can be easily installed even where space is limited: At a height of just 31.5 mm and with robust metal inserts with a female thread, KTM Core and KTM Prime enable simple mounting.



Quick format change thanks to the connection between the contrast sensor and an automation system via an IO-Link interface. Even the standard functions go far beyond the scope of straightforward binary 0/1 switching signals.



The KTM Prime Inox (washdown design) is extremely durable and ideally suited to intensive cleaning and disinfection. Its chemical material resistance and absolute impermeability enable the sensor's long-term use, even in harsh environments.

# PRODUCT FAMILY OVERVIEW

B



**KTM Core**

Mini, easy, speedy



**KTM Prime**

Mini, easy, speedy, robust

**Technical data overview**

<b>Dimensions (W x H x D)</b>	31.5 mm x 21 mm x 12 mm	31.5 mm x 21 mm x 12 mm 48.6 mm x 22.2 mm x 15.25 mm
<b>Sensing distance</b>	12.5 mm	12.5 mm / 11 mm
<b>Light sender, type of light</b>	- LED, white - - -	LED, RGB LED, white - - -
<b>Light spot size</b>	Ø 1 mm Ø 2 mm	Ø 2 mm 1.5 mm x 6.5 mm
<b>Switching frequency</b>	10 kHz	15 kHz
<b>Response time</b>	50 µs	35 µs
<b>Adjustment</b>	Potentiometer, manual / Potentiometer, screw driver	2-point teach-in static/dynamic + proximity to mark
<b>Connection type</b>	Connector M8, 4-pin Cable with connector M12, 4-pin	Connector M8, 4-pin Cable with connector M12, 4-pin

**At a glance**

- |  |  |
|--|--|
| <ul style="list-style-type: none"> <li>• Small, tried-and tested housing</li> <li>• High grayscale resolution</li> <li>• Very large dynamic range means reliable detection of contrasts on glossy materials</li> <li>• Switching frequency: 10 kHz</li> <li>• White light</li> </ul> | <ul style="list-style-type: none"> <li>• Small, tried-and-tested housing, also available in stainless steel</li> <li>• High grayscale resolution</li> <li>• Very large dynamic range means reliable detection of contrasts on glossy materials</li> <li>• Static and dynamic teach-in in one variant</li> <li>• Switching frequency: 15 kHz</li> <li>• KTM Prime with IO-Link functions</li> </ul> |
|--|--|

Detailed information

→ B-24

→ B-30



**KT3L Laser**

Long sensing distance – precise detection



**KT5**

Contrast sensor in standard metal housing

	12 mm x 40 mm x 22 mm	30.4 mm x 53 mm x 80 mm
	40 mm	10 mm 20 mm 40 mm 50 mm
	- - Laser, red - -	LED, RGB LED, white LED, red LED, green -
	1 mm x 2 mm	1.2 mm x 4.2 mm 1.5 mm x 5.5 mm 1.1 mm x 4.2 mm
	1.5 kHz	10 kHz
	400 µs	50 µs
	Static 2-point teach-in	Manual adjustment, potentiometer 1-point-teach-in Static 2-point teach-in Without, automatic contrast detection Dynamic teach-in Static 2-point teach-in with manual fine adjustment
	Connector M12, 4-pin	Connector M12, 4-pin Connector M12, 5-pin

- Very small housing
  - Precise, small laser spot
  - Sensing distance up to 60 mm
  - Simple 2-point teach-in
  - Switching frequency of 1,5 kHz
  - Reliable operation for jittering materials
- B-38

- Best contrast resolution thanks to RGB LED technology
  - Intuitive 10-segment bar display indicates the detection reliability
  - Dynamic or static teach-in method or manual potentiometer
  - Switching frequency of 10 kHz
  - Automatic gloss adjustment for highly reflective materials
  - Various sensing distances and light spot directions
  - M12 plug can be rotated 90°
- B-44



# PRODUCT FAMILY OVERVIEW

B



**KTL5-2 Fiber Optic**

Contrast sensors with fiber-optic cables



**KT6-2**

Easy contrast detection

**Technical data overview**

<b>Dimensions (W x H x D)</b>	30.4 mm x 53 mm x 80 mm	30.4 mm x 53 mm x 80 mm
<b>Sensing distance</b>	Dependent on the fiber-optic cable	10 mm
<b>Type of light</b>	LED, RGB - - LED, green -	LED, RGB - - -
<b>Light spot size</b>	-	1.5 mm x 6.5 mm
<b>Switching frequency</b>	10 kHz	5 kHz
<b>Response time</b>	50 µs	100 µs
<b>Adjustment</b>	Manual adjustment, potentiometer Without, automatic contrast detection Dynamic teach-in Static 2-point teach-in	Static 2-point teach-in
<b>Connection type</b>	Connector M12, 4-pin Connector M12, 5-pin	Connector M12, 4-pin

**At a glance**

- |  |   |
|--|---|
| <ul style="list-style-type: none"> <li>• Various heat-resistant fiber-optic cable models are available</li> <li>• Various teach-in methods, including potentiometer</li> <li>• Analog output</li> <li>• Switching frequency of 10 kHz</li> </ul> | <ul style="list-style-type: none"> <li>• 3-color RGB LED technology</li> <li>• 2-point teach-in (mark and background)</li> <li>• Tough, metal housing</li> <li>• Automatic gloss adjustment for highly reflective materials</li> <li>• 10 mm sensing distance</li> <li>• Light exits at end or side, based on model</li> <li>• Common mounting footprint</li> </ul> |
|--|---|

Detailed information

→ B-58

→ B-66



**KT8**

Laser contrast sensor and CAN communication



**KT10-2**

The industry choice for high-speed and precision mark detection

	30.4 mm x 53 mm x 80 mm	30.4 mm x 53 mm x 80 mm
	10 mm 20 mm 150 mm	10 mm
	LED, RGB - - - Laser, red	LED, RGB - - -
	0.8 mm x 4 mm 1.5 mm x 5.5 mm Ø 0.3 mm Ø 3 mm	0.8 mm x 4 mm
	22.5 kHz 17 kHz	25 kHz
	22 µs 30 µs	20 µs
	Static 2-point teach-in, Dynamic teach-in (min/max)	Static 2-point teach-in, Dynamic teach-in (min/max)
	Male connector M12, 8-pin Connector M12, 5-pin	Connector M12, 5-pin
	<ul style="list-style-type: none"> <li>• Laser version offers sensing distances of 30 mm to 800 mm</li> <li>• Very small and precise laser light spot (Class II)</li> <li>• Fast switching frequency of 17 kHz</li> <li>• Detection reliability displayed in the bar graph display</li> <li>• CAN interface version for parameter setup, diagnostics and function selection</li> <li>• Very precise light spot</li> </ul>	<ul style="list-style-type: none"> <li>• Very low jitter (&lt; 10 µs)</li> <li>• Precise light spot</li> <li>• Best contrast resolution thanks to RGB LED technology</li> <li>• Two interchangeable light exits</li> <li>• Automatic drift correction</li> <li>• Fast switching frequency of 25 kHz</li> <li>• Easy-to-read bar graph display</li> </ul>
	→ B-72	→ B-80

## MINI, EASY, SPEEDY

B



### Product description

Top performance for universal, space-saving use in the packaging industry: The new KTM core contrast sensor from SICK features a high grayscale resolution and is integrated into a small, tried-and-tested housing. The optimized OES4 ASIC technology and a response time of 50 µs ensure reliable and ac-

curate detection of contrast marks, even on glossy materials. The easy adjustment method ensures greater flexibility during commissioning. The KTM reliably detects marks even in conditions with weak contrast ratios and is therefore ideal for use in a wide range of applications.

### At a glance

- Small, tried-and tested housing
- High grayscale resolution
- Very large dynamic range means reliable detection of contrasts on glossy materials
- Switching frequency: 10 kHz
- White light

### Your benefits

- Small housing allows installation even where space is limited
- Powerful, fast contrast sensor ensures high machine throughput
- Good contrast resolution and a very large dynamic range ensure good detection performance on glossy materials, thus increasing the range of application possibilities
- Quick and easy configuration



### Additional information

Detailed technical data . . . . .	B-25
Ordering information . . . . .	B-26
Dimensional drawings . . . . .	B-26
Adjustments . . . . .	B-27
Connection diagram . . . . .	B-27
Sensing distance . . . . .	B-27
Setting the switching threshold . . . . .	B-27
Recommended accessories . . . . .	B-28

→ [www.sick.com/de/en/KTM\\_Core](http://www.sick.com/de/en/KTM_Core)

For more information, just enter the link or scan the QR code and get direct access to technical data, CAD design models, operating instructions, software, application examples and much more.





## Detailed technical data

### Features

<b>Dimensions (W x H x D)</b>	31.5 mm x 21 mm x 12 mm
<b>Sensing distance</b>	12.5 mm
<b>Housing design (light emission)</b>	Rectangular
<b>Sensing distance tolerance</b>	± 3 mm
<b>Light source <sup>1)</sup></b>	LED
<b>Type of light</b>	White
<b>Max. web speed tech-in (dynamic) <sup>2)</sup></b>	1 m/s
<b>Teach-in mode</b>	Potentiometer, manual / Potentiometer, screw driver (depending on type)
<b>Output function</b>	Light/dark switching

<sup>1)</sup> Average service life: 100,000 h at  $T_U = +25\text{ °C}$ .

<sup>2)</sup> At a mark size of 4 mm.

### Mechanics/electronics

<b>Supply voltage <sup>1)</sup></b>	12 V DC ... 24 V DC
<b>Ripple <sup>2)</sup></b>	≤ 5 V <sub>pp</sub>
<b>Power consumption <sup>3)</sup></b>	< 50 mA
<b>Switching frequency <sup>4)</sup></b>	10 kHz
<b>Response time <sup>5)</sup></b>	50 μs
<b>Jitter</b>	25 μs
<b>Switching output</b>	PNP: HIGH = $V_S - \leq 2\text{ V}$ / LOW approx. 0 V, NPN: HIGH = approx. $V_S$ / LOW ≤ 2 V
<b>Output type</b>	PNP, NPN
<b>Output current I<sub>max.</sub> <sup>6)</sup></b>	50 mA
<b>Retention time (ET)</b>	28 ms, non-volatile memory
<b>Connection type</b>	Connector M8, 4-pin / Cable with connector M12, 4-pin (depending on type)
<b>Protection class</b>	III
<b>Circuit protection</b>	$V_S$ connections reverse-polarity protected, Output Q short-circuit protected, Interference suppression
<b>Enclosure rating</b>	IP 67
<b>Weight</b>	
Connector M8, 4-pin	20 g
Cable with connector M12, 4-pin	70 g
<b>Housing material</b>	Plastic, ABS

<sup>1)</sup> Limit values: DC 12 V (-10 %) ... DC 24 V (+20 %). Operation in short-circuit protected network max. 8 A.

<sup>2)</sup> May not exceed or fall below  $U_V$  tolerances.

<sup>3)</sup> Without load.

<sup>4)</sup> With light/dark ratio 1:1.

<sup>5)</sup> Signal transit time with resistive load.

<sup>6)</sup> At supply voltage > 24 V,  $I_{max.} = 30\text{ mA}$ .  $I_{max.}$  is consumption count of all  $Q_n$ .

### Ambient data

<b>Ambient operating temperature</b>	-10 °C ... +55 °C
<b>Ambient storage temperature</b>	-20 °C ... +75 °C
<b>Shock load</b>	According to IEC 60068
<b>UL File No.</b>	
Connector M8, 4-pin	NRKH.E348498 / NRKH.E348498 & NRKH7.E348498 (depending on type)
Cable with connector M12, 4-pin	NRKH.E348498

Ordering information

Other models → [www.sick.com/de/en/KTM\\_Core](http://www.sick.com/de/en/KTM_Core)

KTM Core

Adjustment	Light spot size (distance)	Connection type	Type	Part no.
Potentiometer, manual	Ø 1 mm (10 mm)	Connector M8, 4-pin	KTM-MB8A191P	1066885
	Ø 2 mm (12.5 mm)		KTM-MB31191P	1062203
Potentiometer, screw driver	Ø 2 mm (12.5 mm)	Connector M8, 4-pin	KTM-MB31111P	1062202
		Cable with connector M12, 4-pin	KTM-MB31112P	1070053

B

Dimensional drawings (Dimensions in mm (inch))

KTM-xBxxx91x

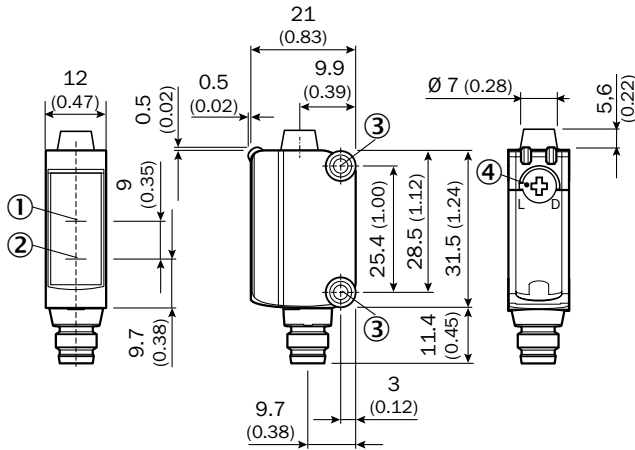

- ① Optical axis receiver
- ② Optical axis sender
- ③ Fixing hole M3
- ④ Light/ dark rotary switch: L = light switching, D = dark switching

KTM-xBxxx11x

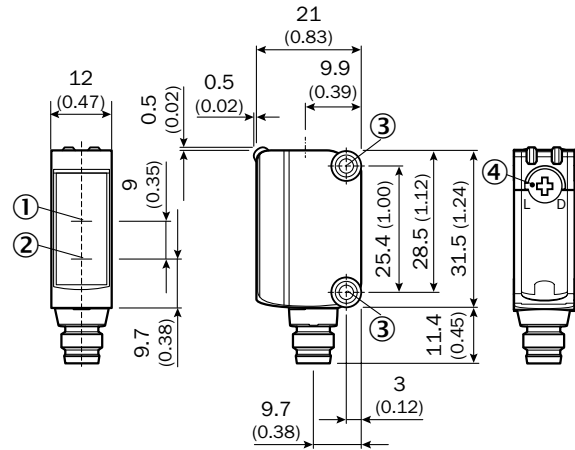

- ① Optical axis receiver
- ② Optical axis sender
- ③ Fixing hole M3
- ④ Light/ dark rotary switch: L = light switching, D = dark switching

KTM-xBxxx12x

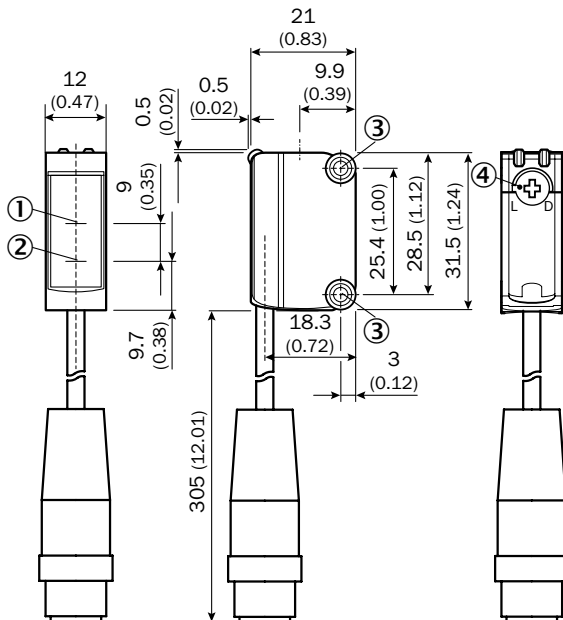

- ① Optical axis receiver
- ② Optical axis sender
- ③ Fixing hole M3
- ④ Light/ dark rotary switch: L = light switching, D = dark switching

## Adjustments

KTM Core

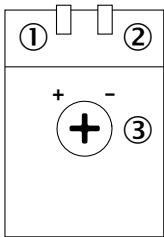

- ① Status indicator LED, yellow: Status switching output Q (dark switching)
- ② Status indicator LED green: supply voltage on
- ③ Switching threshold adjustment

## Connection diagram

Cd-086

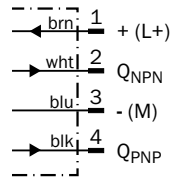

**B**

## Sensing distance

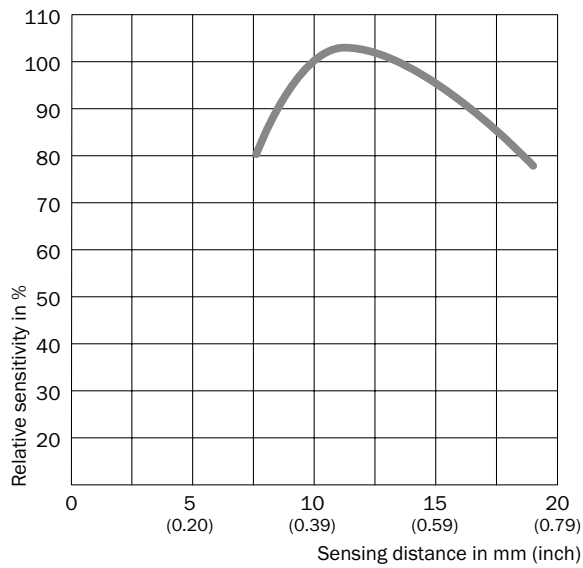

## Setting the switching threshold

For example dark switching

### 1. Position background

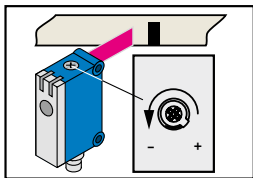

Start at "+" (right-hinged).  
Turn potentiometer in direction "-" until the yellow LED goes out.

### 2. Position mark

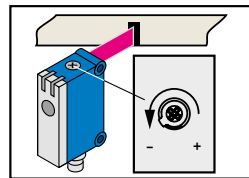

Yellow LED lights up.  
Continue to turn the potentiometer in direction "-" until the yellow LED goes out again.

### 3. Set switching threshold

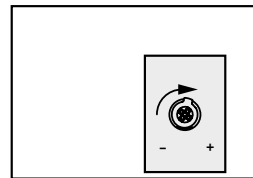

Turn between positions 1 and 2, to ensure that the switching threshold is optimally set.

### Switching characteristics

Light switching: yellow LED ≠ switching output Q  
Dark switching: yellow LED = switching output Q





Light/dark switching selectable by means of rotary switch  
KTM-xBxxx1xx: potentiometer can be adjusted with a screwdriver  
KTM-xBxxx9xx: potentiometer can be adjusted with a screwdriver or by hand



Recommended accessories



Universal bar clamp systems

B

Figure	Material	Description	Type	Part no.
	Steel, zinc coated	Universal clamp bracket for rod mounting	BEF-KHS-KH1	2022726
		Plate L for universal clamp bracket	BEF-KHS-L01	2023057
	Zinc plated steel (sheet), Diecast zinc (clamp)	Plate N08 for universal clamp bracket	BEF-KHS-N08	2051607
	Stainless steel 1.4571 (sheet), Stainless steel 1.4408 (clamp)	Plate N08N for universal clamp bracket	BEF-KHS-N08N	2051616
	Steel, zinc coated	Mounting bar, straight, 200 mm, steel	BEF-MS12G-A	4056054
		Mounting bar, straight, 300 mm, steel	BEF-MS12G-B	4056055
		Mounting bar, L-shaped, 150 mm x 150 mm, steel	BEF-MS12L-A	4056052
		Mounting bar, L-shaped, 250 x 250 mm, steel	BEF-MS12L-B	4056053

Mounting brackets and mounting plates

Mounting brackets

Figure	Material	Description	Type	Part no.
	Stainless steel	Mounting bracket for wall mounting	BEF-W100-A	5311520
	Steel, zinc coated	Mounting bracket for floor mounting	BEF-W100-B	5311521



Mounting plates

Figure	Material	Description	Type	Part no.
	Stainless steel	Adapter plate KT3 to KTM	BEF-AP-KTMS01	2068786



Plug connectors and cables

Connecting cables with female connector

M12, 4-pin, PVC, chemical resistant

Figure	Connection type head A	Connection type head B	Connecting cable	Type	Part no.
	Female connector, M12, 4-pin, straight, unshielded	Cable, open conductor heads	2 m, 4-wire	DOL-1204-G02M	6009382
			5 m, 4-wire	DOL-1204-G05M	6009866
	Female connector, M12, 4-pin, angled, unshielded	Cable, open conductor heads	2 m, 4-wire	DOL-1204-W02M	6009383
			5 m, 4-wire	DOL-1204-W05M	6009867

M8, 4-pin, PVC, chemical resistant

Figure	Connection type head A	Connection type head B	Connecting cable	Type	Part no.
	Female connector, M8, 4-pin, straight, unshielded	Cable, open conductor heads	2 m, 4-wire	DOL-0804-G02M	6009870
			5 m, 4-wire	DOL-0804-G05M	6009872
	Female connector, M8, 4-pin, angled, unshielded	Cable, open conductor heads	2 m, 4-wire	DOL-0804-W02M	6009871
			5 m, 4-wire	DOL-0804-W05M	6009873

→ For additional accessories, please see page K-240

**B**

## MINI, EASY, SPEEDY, ROBUST

B



**IO-Link**

CE III UL LISTED

**Additional information**

Detailed technical data . . . . . B-31  
 Ordering information . . . . . B-32  
 Dimensional drawings . . . . . B-33  
 Adjustments . . . . . B-33  
 Connection diagram . . . . . B-33  
 Sensing distance . . . . . B-34  
 Setting the switching threshold . . B-34  
 Recommended accessories . . . . B-36

### Product description

Top performance for universal, space-saving use in the packaging industry even under harsh conditions: The new KTM prime contrast sensor from SICK features a high grayscale resolution and is integrated into a small, tried-and-tested housing that is also available in stainless steel. The optimized OES4 ASIC technology and a response time of 35  $\mu$ s ensure reliable and accurate detection of contrast marks, even on glossy materials. The various teach-in methods (dynamic, static, and

switching threshold near the marks) ensure greater flexibility during commissioning. The integrated IO-Link interface can be used to access the parameter settings. This speeds up and simplifies format changes. The KTM reliably detects marks even in conditions with weak contrast ratios and is therefore ideal for use in a wide range of applications; in the stainless steel version, it can even be used in harsh environments during intensive cleaning.

### At a glance

- Small, tried-and-tested housing, also available in stainless steel
- High grayscale resolution
- Very large dynamic range means reliable detection of contrasts on glossy materials
- Static and dynamic teach-in in one variant
- Switching frequency: 15 kHz
- KTM Prime with IO-Link functions

### Your benefits

- Small housing allows installation even where space is limited
- Powerful, fast contrast sensor ensures high machine throughput
- Three-color LED technology allows a reliable process, with contrast marks detected even in conditions with weak contrast ratios
- Good contrast resolution and a very large dynamic range ensure good detection performance on glossy materials, thus increasing the range of application possibilities
- Various teach-in methods enable more flexible commissioning
- Long service life, even in harsh environments, thanks to stainless steel housing; as a result, excellent system throughput and low spare parts costs
- Enhanced diagnostics and visualization of sensor parameters, as well as quick and easy format changes, since parameter settings can be downloaded via IO-Link

→ [www.sick.com/de/en/KTM\\_Prime](http://www.sick.com/de/en/KTM_Prime)

For more information, just enter the link or scan the QR code and get direct access to technical data, CAD design models, operating instructions, software, application examples and much more.





## Detailed technical data

### Features

	KTM Prime	KTM Prime Inox
<b>Dimensions (W x H x D)</b>	31.5 mm x 21 mm x 12 mm	48.6 mm x 22.2 mm x 15.25 mm
<b>Sensing distance</b>	12.5 mm	11 mm
<b>Housing design (light emission)</b>	Rectangular	
<b>Sensing distance tolerance</b>	± 3 mm	
<b>Light source <sup>1)</sup></b>	LED	
<b>Type of light</b>	White/RGB	RGB
<b>Wave length</b>	470 nm, 525 nm, 625 nm	
<b>Light spot direction <sup>2)</sup></b>	Vertical	
<b>Max. web speed tech-in (dynamic) <sup>3)</sup></b>	1 m/s	
<b>Teach-in mode</b>	2-point teach-in static/dynamic + proximity to mark	
<b>Output function</b>	Light/dark switching	
<b>IO-Link functions</b>	Standard functions	–

<sup>1)</sup> Average service life: 100,000 h at  $T_U = +25$  °C.

<sup>2)</sup> In relation to long side of housing.

<sup>3)</sup> At a mark size of 4 mm.

### Mechanics/electronics

	KTM Prime	KTM Prime Inox
<b>Supply voltage <sup>1)</sup></b>	12 V DC ... 24 V DC	
<b>Ripple <sup>2)</sup></b>	≤ 5 V <sub>pp</sub>	
<b>Power consumption <sup>3)</sup></b>	< 50 mA	
<b>Switching frequency <sup>4)</sup></b>	15 kHz	
<b>Response time <sup>5)</sup></b>	35 μs	
<b>Jitter</b>	15 μs	
<b>Switching output</b>	PNP / NPN; PNP: HIGH = $V_S - \leq 2$ V / LOW approx. 0 V NPN: HIGH = approx. $V_S$ / LOW ≤ 2 V,	
<b>Output current I<sub>max.</sub> <sup>6)</sup></b>	50 mA	
<b>Input, teach-in (ET)</b>	PNP: Teach: U = 10,8 V ... < U <sub>v</sub> ; Run: U < 2 V or open NPN: Teach: U < 2 V; Run: U <sub>v</sub> - 2 V or open	
<b>Retention time (ET)</b>	28 ms, non-volatile memory	
<b>Connection type</b>	Connector M8, 4-pin / Cable with connector M12, 4-pin (depending on type)	Cable with connector M12, 4-pin
<b>Protection class</b>	III	
<b>Circuit protection</b>	$V_S$ connections reverse-polarity protected, Output Q short-circuit protected, Interference suppression	
<b>Fieldbus interface</b>	IO-Link (depending on type)	
<b>Enclosure rating</b>	IP 67	IP 67, IP 69K
<b>Weight</b>		
Connector M8, 4-pin	10 g	–
Cable with connector M12, 4-pin	25 g	60 g
<b>Housing material</b>	Plastic, ABS	Stainless steel 316L

<sup>1)</sup> Limit values: DC 12 V (–10 %) ... DC 24 V (+20 %). Operation in short-circuit protected network max. 8 A.

<sup>2)</sup> May not exceed or fall below U<sub>v</sub> tolerances.

<sup>3)</sup> Without load.

<sup>4)</sup> With light/dark ratio 1:1.

<sup>5)</sup> Signal transit time with resistive load.

<sup>6)</sup> At supply voltage > 24 V, I<sub>max.</sub> = 30 mA. I<sub>max.</sub> is consumption count of all Q<sub>n</sub>.

Ambient data

	KTM Prime	KTM Prime Inox
<b>Ambient operating temperature</b>	-10 °C ... +55 °C	-30 °C ... +70 °C
<b>Ambient storage temperature</b>	-20 °C ... +75 °C	-30 °C ... +75 °C
<b>Shock load</b>	According to IEC 60068	
<b>UL File No.</b>		
Connector M8, 4-pin	NRKH.E348498 & NRKH7.E348498	-
Cable with connector M12, 4-pin	NRKH.E348498	

B

Ordering information

Other models → [www.sick.com/de/en/KTM\\_Prime](http://www.sick.com/de/en/KTM_Prime)

KTM Prime

Type of light	Light spot size	Output type	Connection type	Connection diagram	Type	Part no.
White	Ø 2 mm	PNP	Connector M8, 4-pin	Cd-092	KTM-MP31181P	1065756
			Cable with connector M12, 4-pin	Cd-092	KTM-MP31182P	1070490
		NPN	Connector M8, 4-pin	Cd-092	KTM-MN31181P	1071947
		PNP, IO-Link	Connector M8, 4-pin	Cd-321	KTM-MP317A1P	1071482
	1.5 mm x 6.5 mm	PNP	Connector M8, 4-pin	Cd-092	KTM-MP11181P	1072473
RGB	1.5 mm x 6.5 mm	PNP	Connector M8, 4-pin	Cd-092	KTM-WP11181P	1062199
			Cable with connector M12, 4-pin	Cd-092	KTM-WP11182P	1062201
			Cable with connector M12, 4-pin	Cd-092	KTM-WP11282P <sup>1)</sup>	1072002
		NPN	Connector M8, 4-pin	Cd-092	KTM-WN11181P	1062200
			Cable with connector M12, 4-pin	Cd-092	KTM-WN11182P	1062150
		PNP, IO-Link	Connector M8, 4-pin	Cd-321	KTM-WP117A1P	1061770
		NPN, IO-Link	Connector M8, 4-pin	Cd-321	KTM-WN117A1P	1061787

<sup>1)</sup> Time delay: 32 ms.

KTM Prime Inox

Type of light	Light spot size	Output type	Connection type	Connection diagram	Type	Part no.
RGB	1.5 mm x 6.5 mm	PNP	Cable with connector M12, 4-pin	Cd-092	KTM-WP1A182V	1052956
		NPN	Cable with connector M12, 4-pin	Cd-092	KTM-WN1A182V	1062148
		PNP, IO-Link	Cable with connector M12, 4-pin	Cd-321	KTM-WP1A7A2V	1062147

**Dimensional drawings** (Dimensions in mm (inch))

**KTM Prime**

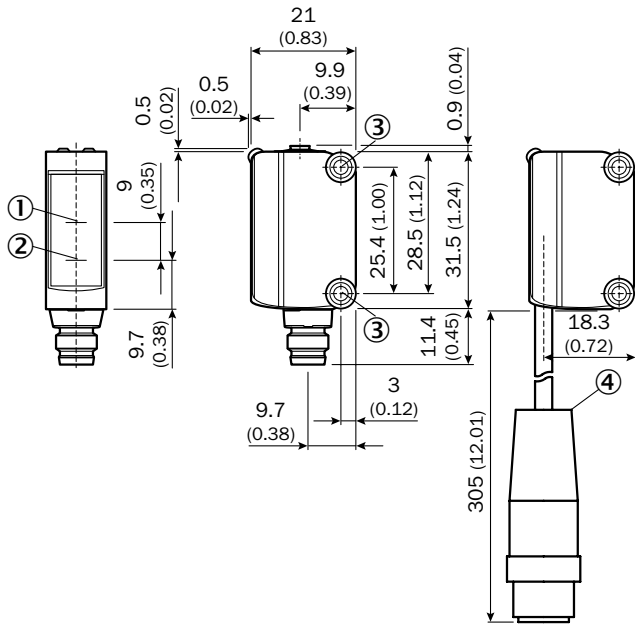

- ① Optical axis receiver
- ② Optical axis sender
- ③ Fixing hole M3
- ④ Cable with male connector M12 (only KTM-xxxxx2x)

**KTM Prime Inox**

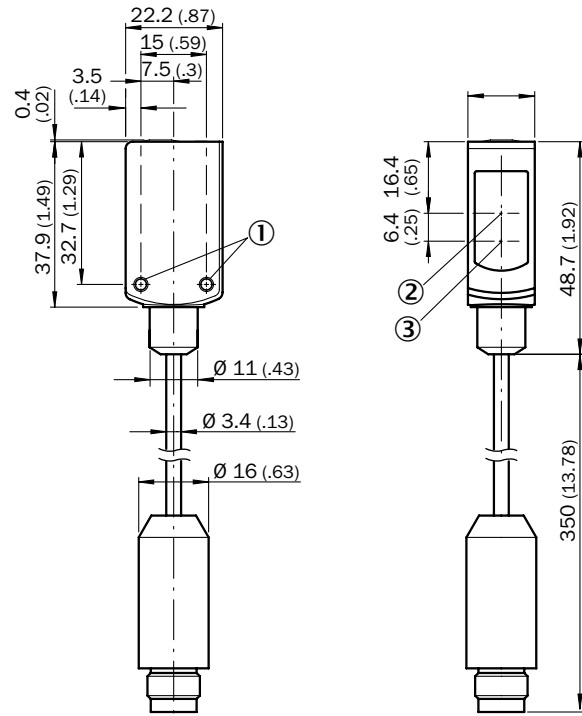

- ① Fixing hole M3
- ② Optical axis receiver
- ③ Optical axis sender

**Adjustments**

**KTM Prime**

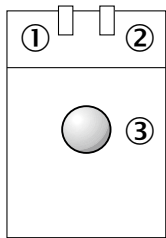

- ① Status indicator LED, yellow: Status switching output Q (dark switching)
- ② Status indicator LED green: supply voltage on
- ③ Teach-in button

**KTM Prime Inox**

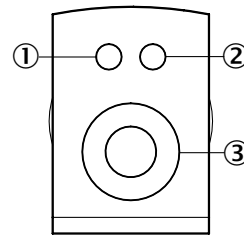

- ① Status indicator LED, yellow: Status switching output Q
- ② Status indicator LED green: supply voltage on
- ③ Teach-in button

**Connection diagram**

**Cd-092**

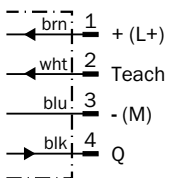

**Cd-321**

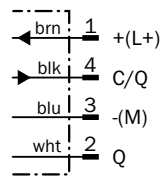

B

### Sensing distance

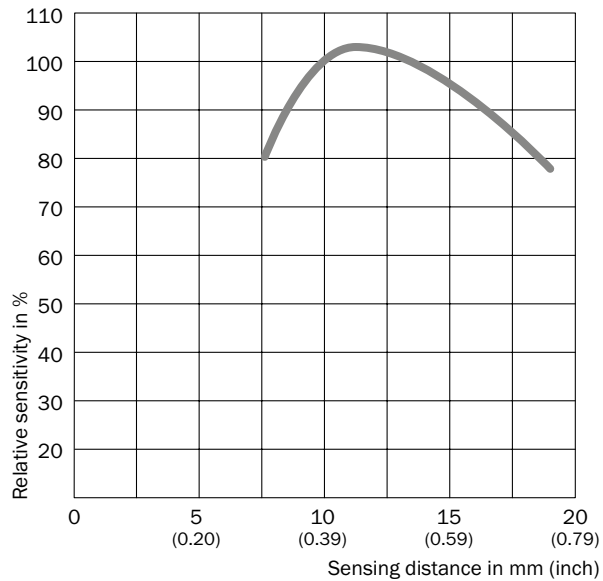

### Setting the switching threshold

#### Teach-in static

##### 1. Position mark

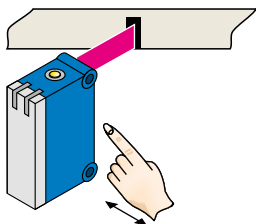

Press and hold teach-in button > 1 < 3 s.  
Yellow LED flashes slowly.

##### 2. Position background

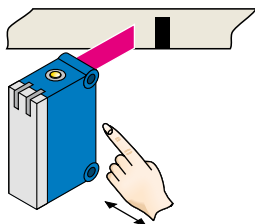

Press and hold teach-in button < 3 s.  
Yellow LED goes out.



## Teach-in dynamic

### 1. Position background

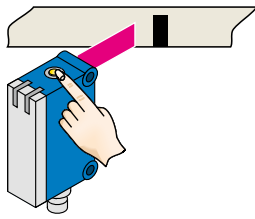

Press the teach-in button and keep it pressed. LED flashing slowly.

### 2. Move at least the mark and background using the light spot.

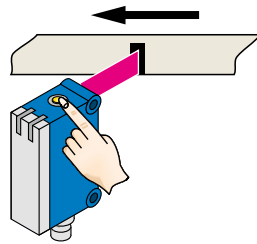

Keep the teach-in button > 3 < 30 s pressed.

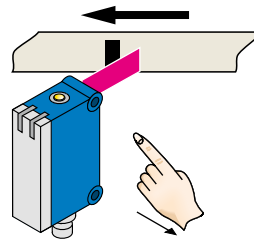

Release the teach-in button.

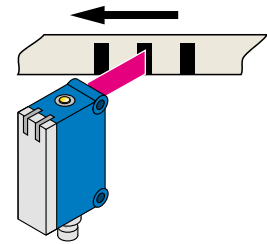

Yellow LED will illuminate, when emitted light is on the mark.

**B**

### Example

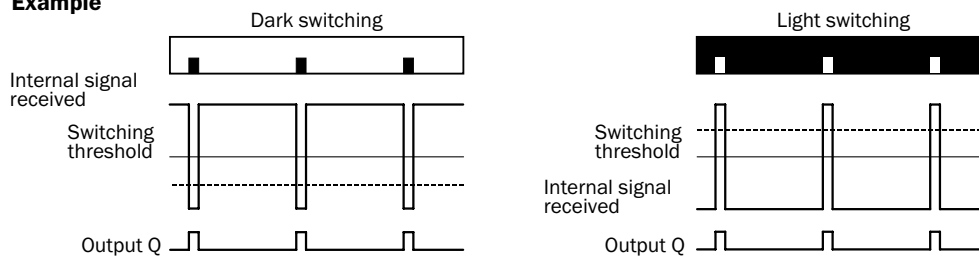

### Switching characteristics

The optimum emitted light is selected automatically (at RGB variants).

Static teach-in: light/dark setting is defined using teach-in sequence.

Dynamic teach-in: switching output active on mark, if background is longer in the field of view during the teach-in.

The switching threshold is set in the center between the background and the mark.

If the button is pressed again within 10 s of the teach ( $> 20 \text{ ms} < 10 \text{ s}$ ), the relative switching threshold is placed 75 % between mark (100 %) and background (0 %) (dotted line in Figure).

Teach-in can also be performed using an external control signal (only dynamic teach-in).

Keylock activation and deactivation: hold down teach-in button  $> 30 \text{ s}$ .

Teach-in failure: yellow LED indicator and the transmitted light of the sensor flashing quickly.



For dynamic teach-in with ET signal (5 Hz) via switching output Q.

Recommended accessories

Modules and gateways



Connection modules

B

Figure	Description	Type	Part no.
	IO-Link version V1.1, Port class 2, PIN 2, 4, 5 galvanically connected, Supply voltage 18 V DC ... 32 V DC (limit values, operation in short-circuit protected network max. 8 A)	SICK Memory Stick	1064290
	IO-Link V1.1 Class A port, USB2.0 port, optional external power supply 24V / 1A	SiLink2 Master	1061790

Mounting brackets and mounting plates

Mounting brackets

Figure	Material	Description	Type	Part no.
	Stainless steel	Mounting bracket for wall mounting	BEF-W100-A	5311520
	Steel, zinc coated	Mounting bracket for floor mounting	BEF-W100-B	5311521



Mounting plates

Figure	Material	Description	Type	Part no.
	Stainless steel	Adapter plate KT3 to KTM	BEF-AP-KTMS01	2068786



Plug connectors and cables

Connecting cables with female connector

M12, 4-pin, PVC, chemical resistant

Figure	Connection type head A	Connection type head B	Connecting cable	Type	Part no.
	Female connector, M12, 4-pin, straight, unshielded	Cable, open conductor heads	2 m, 4-wire	DOL-1204-G02M	6009382
			5 m, 4-wire	DOL-1204-G05M	6009866
	Female connector, M12, 4-pin, angled, unshielded	Cable, open conductor heads	2 m, 4-wire	DOL-1204-W02M	6009383
			5 m, 4-wire	DOL-1204-W05M	6009867

M8, 4-pin, PVC, chemical resistant

Figure	Connection type head A	Connection type head B	Connecting cable	Type	Part no.
	Female connector, M8, 4-pin, straight, unshielded	Cable, open conductor heads	2 m, 4-wire	DOL-0804-G02M	6009870
			5 m, 4-wire	DOL-0804-G05M	6009872
	Female connector, M8, 4-pin, angled, unshielded	Cable, open conductor heads	2 m, 4-wire	DOL-0804-W02M	6009871
			5 m, 4-wire	DOL-0804-W05M	6009873

→ For additional accessories, please see page K-240



**B**

## LONG SENSING DISTANCE – PRECISE DETECTION

B



The image shows a SICK KT3L Laser contrast sensor. It is a compact, rectangular device with a blue top half and a black bottom half. The top half has a yellow laser spot and a red laser line. The bottom half has a threaded mounting base. The label on the side of the sensor includes the SICK logo, the model number KT3L-P32245, the serial number 1.328.244, the DC voltage 12-24V, the current 0A-300mA, and the text 'Made in Germany'. There are also CE and UL listed logos on the label.

**CE**   **cUL US LISTED**

**CDRH**

**Additional information**

Detailed technical data . . . . . B-39  
 Ordering information . . . . . B-40  
 Dimensional drawings . . . . . B-40  
 Adjustments . . . . . B-40  
 Connection diagram . . . . . B-41  
 Sensing distance . . . . . B-41  
 Setting the switching threshold . . B-41  
 Recommended accessories . . . . B-42

### Product description

The KT3L Laser contrast sensor is ideally suited for detecting small contrast marks (1 x 1 mm<sup>2</sup>). The small, precise laser spot can detect objects at any distance, making the KT3L suitable for a wide range of contrast detection applications that require long sensing distances. The sensor, which is ideal for distances from 20 mm to 60 mm,

functions reliably even if the distance between the sensor and the object fluctuates during operation. The compact housing allows it to be installed in the tightest spaces. Plus, simple 2-point teach-in where the operator teaches the mark and the background enables quick setup.

### At a glance

- Very small housing
- Precise, small laser spot
- Sensing distance up to 60 mm
- Simple 2-point teach-in
- Switching frequency of 1,5 kHz
- Reliable operation for jittering materials

### Your benefits

- Compact design fits in applications with limited space
- Small, precise light spot detects the smallest contrast marks, e.g., 1 x 1 mm<sup>2</sup>, using Class II laser technology
- Long sensing distances up to 60 mm enable flexible installation
- The sensor's long depth-of-field ensures that it can be used at various sensing distances
- Automatic adaptation for high-gloss objects ensures high throughput
- Reliable operation for jittering materials

→ [www.sick.com/de/en/KT3](http://www.sick.com/de/en/KT3)

For more information, just enter the link or scan the QR code and get direct access to technical data, CAD design models, operating instructions, software, application examples and much more.





## Detailed technical data

### Features

<b>Dimensions (W x H x D)</b>	12 mm x 40 mm x 22 mm
<b>Sensing distance</b>	40 mm
<b>Housing design (light emission)</b>	Rectangular
<b>Sensing distance tolerance</b>	± 20 mm
<b>Light source <sup>1)</sup></b>	Laser
<b>Type of light</b>	Visible red light
<b>Wave length</b>	655 nm
<b>Light spot size</b>	1 mm x 2 mm
<b>Light spot direction <sup>2)</sup></b>	Vertical
<b>Laser class</b>	II
<b>Operating distance</b>	20 mm ... 60 mm
<b>Teach-in mode</b>	Static 2-point teach-in

<sup>1)</sup> Average service life 50,000 h at  $T_A = +25\text{ °C}$ .

<sup>2)</sup> In relation to long side of housing.

### Mechanics/electronics

<b>Supply voltage <sup>1)</sup></b>	10 V DC ... 30 V DC
<b>Ripple <sup>2)</sup></b>	≤ 5 V <sub>pp</sub>
<b>Power consumption <sup>3)</sup></b>	< 35 mA
<b>Switching frequency <sup>4)</sup></b>	1.5 kHz
<b>Response time <sup>5)</sup></b>	400 μs
<b>Switching output</b>	PNP: HIGH = $V_S - \leq 2\text{ V}$ / LOW approx. 0 V / NPN: HIGH = approx. $V_S$ / LOW ≤ 2 V,
<b>Output type</b>	PNP / NPN (depending on type)
<b>Output current I<sub>max.</sub></b>	100 mA
<b>Input, teach-in (ET)</b>	PNP: Teach U > 8 V; Run: U < 2 V NPN: Teach: U < 2 V; Run: U = U <sub>v</sub>
<b>Retention time (ET)</b>	25 ms, non-volatile memory
<b>Connection type</b>	Connector M12, 4-pin
<b>Protection class <sup>6)</sup></b>	II
<b>Circuit protection</b>	$V_S$ connections reverse-polarity protected, Output Q short-circuit protected, Interference suppression
<b>Enclosure rating</b>	IP 67
<b>Weight</b>	11 g
<b>Housing material</b>	Plastic, ABS

<sup>1)</sup> Limit values; operation in short-circuit protected network max. 8 A.

<sup>2)</sup> May not exceed or fall below U<sub>v</sub> tolerances.

<sup>3)</sup> Without load.

<sup>4)</sup> With light/dark ratio 1:1.

<sup>5)</sup> Signal transit time with resistive load.

<sup>6)</sup> Reference voltage DC 50 V.

### Ambient data

<b>Ambient operating temperature</b>	-10 °C ... +45 °C
<b>Ambient storage temperature</b>	-20 °C ... +75 °C
<b>Shock load</b>	According to IEC 60068
<b>UL File No.</b>	NRKH.E181493 & NRKH7.E181493, CDRH-conform

## Ordering information

Other models → [www.sick.com/de/en/KT3](http://www.sick.com/de/en/KT3)

## KT3L Laser

Light spot size	Light spot direction <sup>1)</sup>	Adjustment	Output type	Type	Part no.
1 mm x 2 mm	Vertical	Static 2-point teach-in	PNP	KT3L-P3216	1026244
			NPN	KT3L-N3216	1026245

<sup>1)</sup> In relation to long side of housing.

**B**

## Dimensional drawings

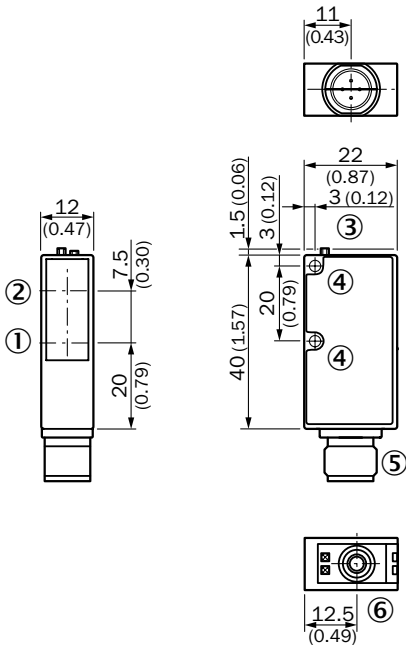

- ① Center of optical axis, sender
- ② Center of optical axis, receiver
- ③ LED signal strength indicator
- ④ Mounting hole, Ø 3 mm
- ⑤ Male connector M12
- ⑥ Teach-in button

## Adjustments

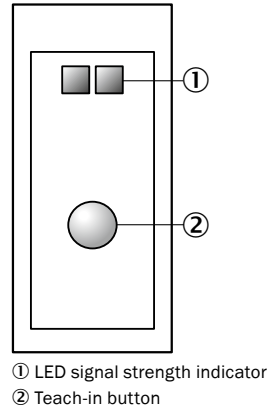

Connection diagram

Cd-092

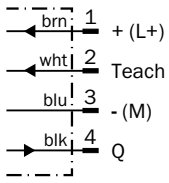

Sensing distance

KT3L Laser

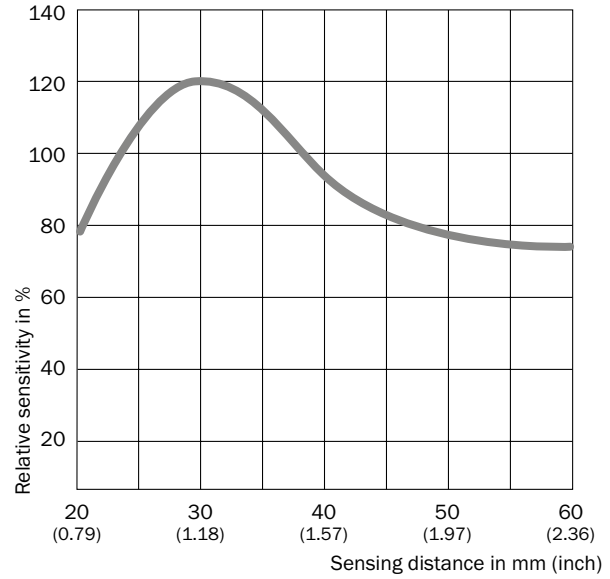

**B**

Setting the switching threshold

Teach-in static

1. Position mark

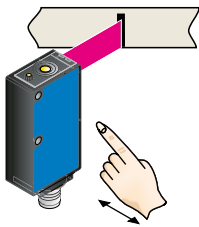

Press and hold teach-in button > 1 s.  
Yellow LED flashes slowly.

2. Position background

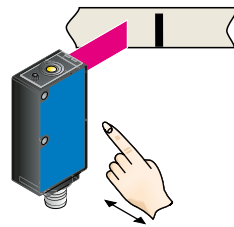

Press and hold teach-in button > 1 s.  
Yellow LED goes out.

Example

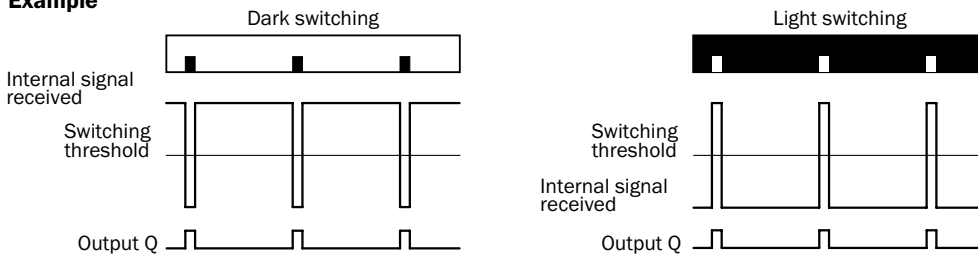



Switching characteristics

The optimum emitted light is selected automatically.  
Light/dark setting is defined using teach-in sequence.  
The switching threshold is set in the center between the background and the mark.  
Teach-in can also be performed using an external control signal.

Recommended accessories

Universal bar clamp systems

B

Figure	Material	Description	Type	Part no.
	Steel, zinc coated	Universal clamp bracket for rod mounting	BEF-KHS-KH1	2022726
		Plate L for universal clamp bracket	BEF-KHS-L01	2023057
		Mounting bar, straight, 200 mm, steel	BEF-MS12G-A	4056054
		Mounting bar, straight, 300 mm, steel	BEF-MS12G-B	4056055
		Mounting bar, L-shaped, 150 mm x 150 mm, steel	BEF-MS12L-A	4056052
		Mounting bar, L-shaped, 250 x 250 mm, steel	BEF-MS12L-B	4056053

Mounting brackets and mounting plates



Mounting brackets

Figure	Material	Description	Type	Part no.
	Steel, zinc coated	Mounting bracket	BEF-WN-W9-2	2022855

Plug connectors and cables

Connecting cables with female connector

M12, 4-pin, PVC, chemical resistant

Figure	Connection type head A	Connection type head B	Connecting cable	Type	Part no.
	Female connector, M12, 4-pin, straight, unshielded	Cable, open conductor heads	2 m, 4-wire	DOL-1204-G02M	6009382
			5 m, 4-wire	DOL-1204-G05M	6009866
	Female connector, M12, 4-pin, angled, unshielded	Cable, open conductor heads	2 m, 4-wire	DOL-1204-W02M	6009383
			5 m, 4-wire	DOL-1204-W05M	6009867

→ For additional accessories, please see page K-240





# CONTRAST SENSOR IN STANDARD METAL HOUSING

B



## Product description

KT5-2 contrast sensors are ideal for high-precision contrast detection, such as detecting marks on high-gloss materials. Thanks to the 3-color LED, the sensors are able to activate the best-possible emitted light source for each contrast. The device also offers various possibilities for adapting the switching point to the application via teach-in process or potentiometer. The sensor defines all necessary parameters automatically. The sensor then determines

the ideal switching threshold from the two gray values detected. High-precision contrast detection, automatic gloss adaptation for highly reflective objects, a sensing distance of 10 mm, 20 mm and 40 mm, switching frequency of 10 kHz and individual alignment and mounting options make the device suitable for a wide range of tasks. Simple mounting is also ensured – the M12 plug connection can be rotated 90°.

## At a glance

- Best contrast resolution thanks to RGB LED technology
- Intuitive 10-segment bar display indicates the detection reliability
- Dynamic or static teach-in method or manual potentiometer
- Switching frequency of 10 kHz
- Automatic gloss adjustment for highly reflective materials
- Various sensing distances and light spot directions
- M12 plug can be rotated 90°

## Your benefits

- Able to process all packaging materials (yellow mark/white background), resulting in high machine throughput
- Reliable operation, even with jittering and high gloss materials
- High positioning accuracy improves packaging quality
- Simple teach-in and highly visible light spot ensure easy setup
- A range of sensing distances, light spot directions and 90° rotatable plug enables optimal integration
- Interchangeable lenses for maximum mounting flexibility

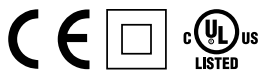

## Additional information

Detailed technical data . . . . .B-45  
 Ordering information . . . . .B-46  
 Dimensional drawings . . . . .B-49  
 Adjustments . . . . .B-50  
 Connection diagram. . . . .B-51  
 Sensing distance . . . . .B-51  
 Setting the switching threshold . .B-52  
 Recommended accessories . . . .B-56

→ [www.sick.com/de/en/KT5](http://www.sick.com/de/en/KT5)

For more information, just enter the link or scan the QR code and get direct access to technical data, CAD design models, operating instructions, software, application examples and much more.



## Detailed technical data

## Features

	KT5-2 Potentiometer	KT5-2 Teach-in	KT5-2 Display
Dimensions (W x H x D)	30.4 mm x 53 mm x 80 mm		
Sensing distance <sup>1)</sup>	10 mm / 20 mm / 40 mm / 50 mm (depending on type)	10 mm / 20 mm / 40 mm (depending on type)	
Housing design (light emission)	Rectangular		
Sensing distance tolerance	± 3 mm		
Light source <sup>2)</sup>	LED		
Type of light	White Green (depending on type)	Green Red RGB	RGB
Light emission	Long and short side of housing, exchangeable		
Function	-	Off delay 20 ms (depending on type)	-
Output function	Light/dark switching adjustable	Light/dark switching (determined Teach-in sequence)	

<sup>1)</sup> From front edge of lens.

<sup>2)</sup> Average service life: 100,000 h at  $T_U = +25\text{ °C}$ .

## Mechanics/electronics

	KT5-2 Potentiometer	KT5-2 Teach-in	KT5-2 Display
Supply voltage <sup>1)</sup>	10 V DC ... 30 V DC		
Ripple <sup>2)</sup>	≤ 5 V <sub>pp</sub>		
Power consumption <sup>3)</sup>	< 80 mA		< 130 mA
Switching frequency <sup>4)</sup>	10 kHz		
Response time <sup>5)</sup>	50 μs		
Switching output	PNP: HIGH = $V_S - \leq 2\text{ V}$ / LOW approx. 0 V NPN: HIGH = approx. $V_S$ / LOW ≤ 2 V,		
Output type	PNP / NPN		
Analog output $Q_A$	0.3 mA ... 10 mA	-	
Output current $I_{max}$	100 mA <sup>6)</sup>		
Input, teach-in (ET)	-	PNP Teach: $U = 10\text{ V} \dots < U_V$ Run: $U < 2\text{ V}$ NPN Teach: $U < 2\text{ V}$ Run: $U = 10\text{ V} \dots < U_V$	
Input, light/dark (L/D)	-	PNP Light: $U = 0\text{ V}$ Dark: $U > 10\text{ V} \dots < U_V$ NPN: light: $U = U_V$ Dark: $U = 0\text{ V}$ (depending on type)	
Retention time (ET)	-	25 ms, non-volatile memory	
Time delay	20 ms		
Connection type	Connector M12, 4-pin	Connector M12, 5-pin	Connector M12, 5-pin
Protection class	II <sup>7)</sup>	II <sup>7)</sup> / III (KT5RG)	II <sup>7)</sup>
Circuit protection	$V_S$ connections reverse-polarity protected, Output Q short-circuit protected, Interference suppression		

B

	KT5-2 Potentiometer	KT5-2 Teach-in	KT5-2 Display
Enclosure rating	IP 67		
Weight	400 g	-	
Housing material	Metal, zinc diecast		

<sup>1)</sup> Limit values; operation in short-circuit protected network max. 8 A.

<sup>2)</sup> May not exceed or fall below  $U_v$  tolerances.

<sup>3)</sup> Without load.

<sup>4)</sup> With light/dark ratio 1:1.

<sup>5)</sup> Signal transit time with resistive load.

<sup>6)</sup> Short-circuit protected.

<sup>7)</sup> Reference voltage DC 50 V.

### Ambient data

	KT5-2 Potentiometer	KT5-2 Teach-in	KT5-2 Display
Ambient operating temperature	-10 °C ... +55 °C		
Ambient storage temperature	-25 °C ... +75 °C		
Shock load	According to IEC 60068		
UL File No.	NRKH.E181493 & NRKH7.E181493		

### Ordering information

Other models → [www.sick.com/de/en/KT5](http://www.sick.com/de/en/KT5)

#### KT5-2 Potentiometer, white

- **Wave length:** 450 ... 650 nm
- **Adjustment:** Manual adjustment, potentiometer
- **Connection:** Male connector M12, 4-pin

Sensing distance <sup>1)</sup>	Light spot size	Light spot direction <sup>2)</sup>	Output type	Analog output	Connection diagram	Type	Part no.
10 mm	1.2 mm x 4.2 mm	Vertical	PNP	0.3 mA ... 10 mA	Cd-327	KT5M-2P1151	1044400
			NPN	-	Cd-327	KT5M-2N1111	1048489

<sup>1)</sup> From front edge of lens.

<sup>2)</sup> In relation to long side of housing.



KT5-2 Potentiometer, green

- **Wave length:** 520 nm
- **Adjustment:** Manual adjustment, potentiometer
- **Connection:** Male connector M12, 4-pin

Sensing distance <sup>1)</sup>	Light spot size	Light spot direction <sup>2)</sup>	Output type	Time delay	Connection diagram	Type	Part no.	
10 mm	1.2 mm x 4.2 mm	Vertical	PNP	-	Cd-327	KT5G-2P1111	1015993	
				20 ms	Cd-327	KT5G-2P1121	1015997	
			NPN	-	Cd-327	KT5G-2N1111	1015981	
		20 ms		Cd-327	KT5G-2N1121	1015983		
		Horizontal		PNP	-	Cd-327	KT5G-2P2111	1016008
			20 ms		Cd-327	KT5G-2P2121	1016009	
NPN	-		Cd-327	KT5G-2N2111	1015990			
	20 mm	1.5 mm x 5.5 mm	Vertical	PNP	-	Cd-327	KT5G-2P1211	1015999
20 ms					Cd-327	KT5G-2P1221	1016001	
NPN				-	Cd-327	KT5G-2N1211	1015985	
			Horizontal	PNP	-	Cd-327	KT5G-2P2211	1016010
					20 ms	Cd-327	KT5G-2P2221	1016011
NPN			-	Cd-327	KT5G-2N2211	1015991		
	40 mm	1.1 mm x 4.2 mm	Vertical	PNP	-	Cd-327	KT5G-2P1311	1016003
20 ms					Cd-327	KT5G-2P1321	1016005	
NPN				-	Cd-327	KT5G-2N1311	1015988	
			Horizontal	PNP	-	Cd-327	KT5G-2P2311	1016012
					20 ms	Cd-327	KT5G-2P2321	1016013
NPN			-	Cd-327	KT5G-2N2311	1015992		

<sup>1)</sup> From front edge of lens.

<sup>2)</sup> In relation to long side of housing.

KT5-2 Potentiometer, green, analog output

- **Wave length:** 520 nm
- **Adjustment:** Manual adjustment, potentiometer
- **Analog output:** 0.3 mA ... 10 mA
- **Connection:** Male connector M12, 4-pin

Sensing distance <sup>1)</sup>	Light spot size	Light spot direction <sup>2)</sup>	Output type	Connection diagram	Type	Part no.
10 mm	1.2 mm x 4.2 mm	Vertical	PNP	Cd-327	KT5G-2P1151	1016195
			NPN	Cd-327	KT5G-2N1151	1016385
		Horizontal	PNP	Cd-327	KT5G-2P2151	1017809
20 mm	1.5 mm x 5.5 mm	Vertical	PNP	Cd-327	KT5G-2P1251	1016196
			NPN	Cd-327	KT5G-2N1251	1022582
40 mm	1.1 mm x 4.2 mm	Vertical	PNP	Cd-327	KT5G-2P1351	1016197
			NPN	Cd-327	KT5G-2N1351	1016728
		Horizontal	PNP	Cd-327	KT5G-2P2351	1018067
			NPN	Cd-327	KT5G-2N2351	1018068

<sup>1)</sup> From front edge of lens.

<sup>2)</sup> In relation to long side of housing.

KT5-2 Teach-in, red / green

- **Wave length:** 640 nm, 525 nm
- **Connection:** Male connector M12, 5-pin

Adjustment	Sensing distance <sup>1)</sup>	Light spot size	Light spot direction <sup>2)</sup>	Output type	Time delay	Connection diagram	Type	Part no.
Static 2-point teach-in	10 mm	1.2 mm x 4.2 mm	Vertical	PNP	-	Cd-066	KT5RG-2P1116	1027393
					20 ms	Cd-066	KT5RG-2P1126	1027396
				NPN	-	Cd-066	KT5RG-2N1116	1027394

<sup>1)</sup> From front edge of lens.

<sup>2)</sup> In relation to long side of housing.

KT5-2 Teach-in, RGB

- **Wave length:** 640 nm, 525 nm, 470 nm
- **Connection:** Male connector M12, 5-pin

Adjustment	Sensing distance <sup>1)</sup>	Light spot size	Light spot direction <sup>2)</sup>	Output type	Time delay	Connection diagram	Type	Part no.
Dynamic teach-in	10 mm	1.2 mm x 4.2 mm	Vertical	PNP	-	Cd-324	KT5W-2P1113	1016629
					20 ms	Cd-324	KT5W-2P1123	1017810
			Horizontal	PNP	-	Cd-324	KT5W-2N1113	1016630
					-	Cd-324	KT5W-2P2113	1018043
	20 mm	1.5 mm x 5.5 mm	Vertical	PNP	-	Cd-324	KT5W-2P1213	1016715
					-	Cd-324	KT5W-2N1213	1016716
	40 mm	1.1 mm x 4.2 mm	Horizontal	PNP	20 ms	Cd-324	KT5W-2P2323	1022165
	Static 2-point teach-in	10 mm	1.2 mm x 4.2 mm	Vertical	PNP	-	Cd-323	KT5W-2P1116
20 ms						Cd-323	KT5W-2P1126	1018587
NPN				-	Cd-323	KT5W-2N1116	1018045	
20 mm		1.5 mm x 5.5 mm	Vertical	PNP	-	Cd-323	KT5W-2P2116	1022312
					-	Cd-323	KT5W-2P1216	1018586
			Horizontal	PNP	-	Cd-323	KT5W-2N1216	1019022
-		Cd-323			KT5W-2P2216	1019020		
40 mm		1.1 mm x 4.2 mm	Vertical	PNP	-	Cd-323	KT5W-2P1316	1018961
					-	Cd-323	KT5W-2N1316	1022678

<sup>1)</sup> From front edge of lens.

<sup>2)</sup> In relation to long side of housing.

**KT5-2 Display**

- **Wave length:** 470 nm, 525 nm, 640 nm
- **Connection:** Male connector M12, 5-pin

Adjustment	Sensing distance <sup>1)</sup>	Light spot size	Light spot direction <sup>2)</sup>	Output type	Time delay	Connection diagram	Type	Part no.
Static 2-point teach-in with manual fine adjustment	10 mm	1.2 mm x 4.2 mm	Vertical	PNP	-	Cd-323	KT5W-2P1116D	1026538
					20 ms	Cd-323	KT5W-2P1126D	1026579
				NPN	-	Cd-323	KT5W-2N1116D	1026540
					20 ms	Cd-323	KT5W-2N1126D	1026582
			Horizontal	PNP	-	Cd-323	KT5W-2P2116D	1026584
					NPN	-	Cd-323	KT5W-2N2116D
	20 mm	1.5 mm x 5.5 mm	Vertical	PNP	-	Cd-323	KT5W-2P1216D	1026577
					NPN	-	Cd-323	KT5W-2N1216D
				PNP	-	Cd-323	KT5W-2P1316D	1026578
					NPN	-	Cd-323	KT5W-2N1316D

<sup>1)</sup> From front edge of lens.

<sup>2)</sup> In relation to long side of housing.

**Dimensional drawings** (Dimensions in mm (inch))

**KT5-2 Potentiometer**

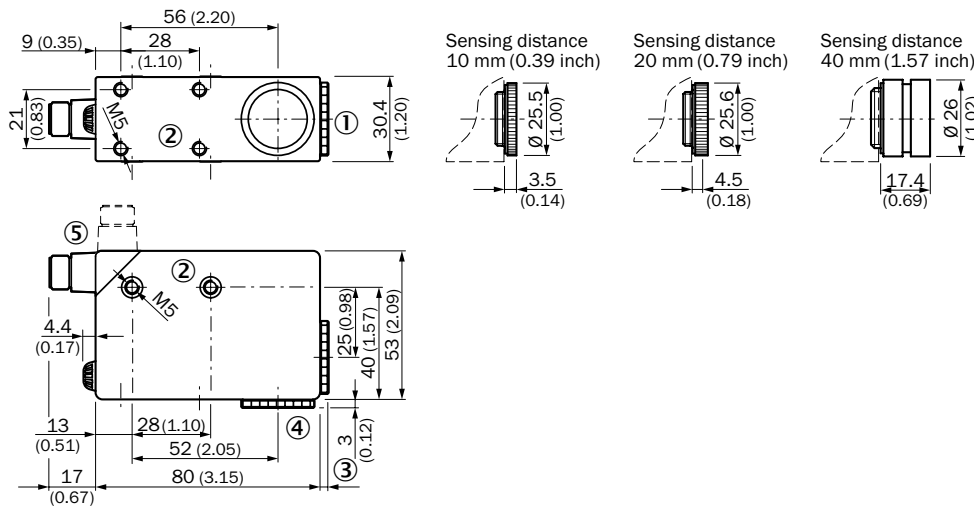

- ① Lens (light transmission), can be exchanged for pos. 4
- ② M5 threaded mounting hole, 5.5 mm deep
- ③ See dimensional drawing for lens
- ④ Blind screw can be replaced by pos. 1
- ⑤ Connector M12 (rotatable up to 90°)

B

KT5-2 Teach-in, KT5-2 Display

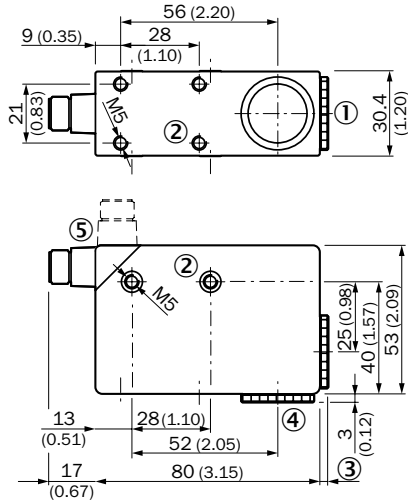

Sensing distance 10 mm (0.39 inch)

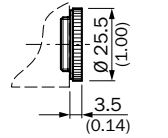

Sensing distance 20 mm (0.79 inch)

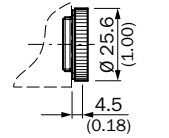

Sensing distance 40 mm (1.57 inch)

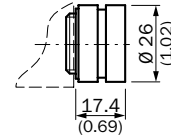

- ① Lens (light transmission), can be exchanged for pos. 4
- ② M5 threaded mounting hole, 5.5 mm deep
- ③ See dimensional drawing for lens
- ④ Blind screw can be replaced by pos. 1
- ⑤ Connector M12 (rotatable up to 90°)

Adjustments

KT5-2 Potentiometer

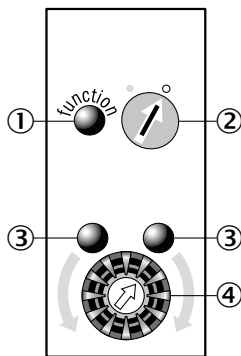

- ① Function signal indicator (yellow)
- ② Pre-selection switch (light/dark switching)
- ③ Switching threshold adjustment
- ④ Adjustment indicators (green)

KT5-2 Teach-in, KT5G-xxx6, KT5W-xxx6

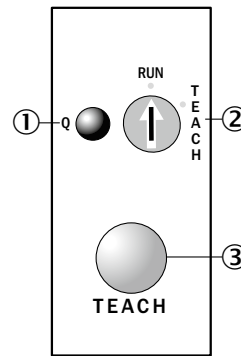

- ① Function signal indicator (yellow)
- ② Pre-selection switch
- ③ Teach-in button

KT5-2 Teach-in, KT5RG-xxx6

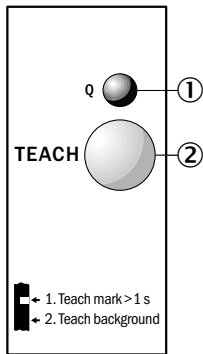

- ① Function signal indicator (yellow)
- ② Teach-in button

KT5-2 Teach-in, KT5W-xxx3

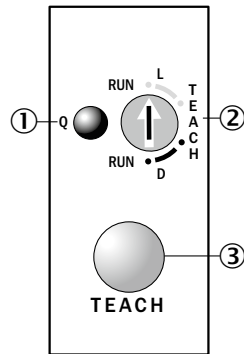

- ① Function signal indicator (yellow)
- ② Pre-selection switch
- ③ Teach-in button

KT5-2 Display

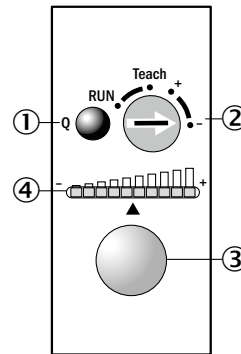

- ① Function signal indicator (yellow)
- ② Pre-selection switch
- ③ Teach-in button
- ④ Bar graph (green)

Connection diagram

Cd-066

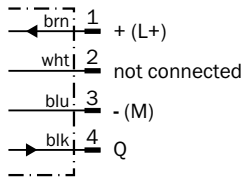

Cd-323

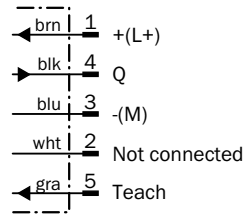

Cd-324

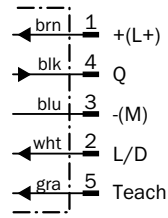

Cd-327

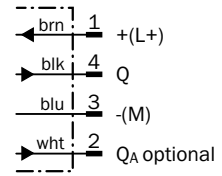

**B**

Sensing distance

KT5-2 Teach-in, KT5G, KT5W, KT5-2 Display

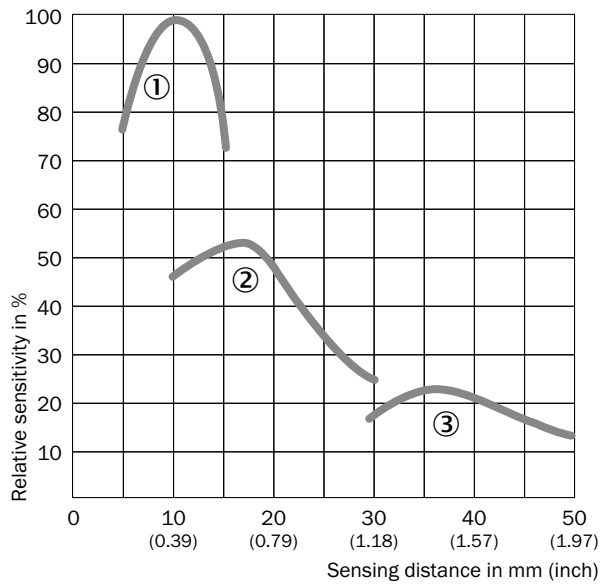

- ① Sensing distance 10 mm
- ② Sensing distance 20 mm
- ③ Sensing distance 40 mm

KT5-2 Teach-in, KT5RG-xxx6

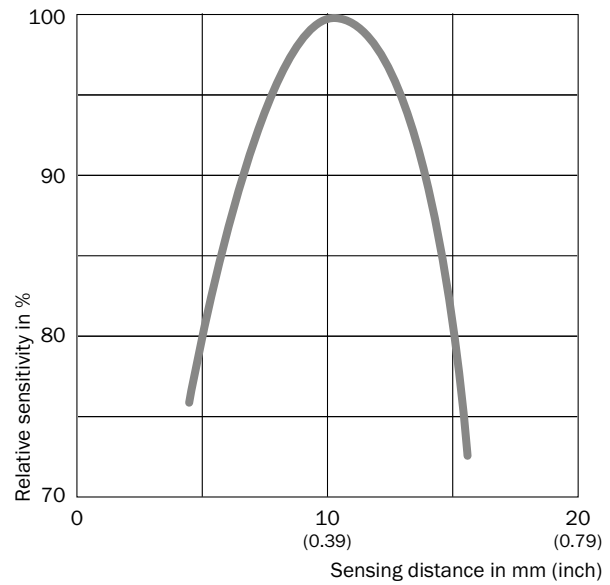



Setting the switching threshold

KT5-2 Potentiometer

1. Select switching function (light/dark)

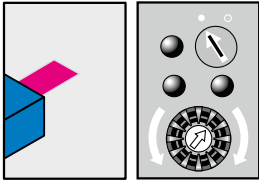

Turn the rotary switch to the desired position.  
 ○ = light switching  
 ● = dark switching

2. Position mark

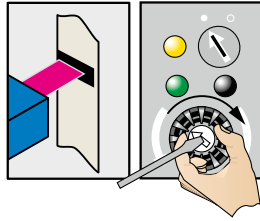

Turn potentiometer in the direction shown (green LED illuminates) until the yellow LED status changes and the green LED opposite illuminates.

3. Position background

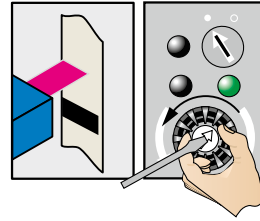

Gradually turn back the potentiometer (count the number of turns) until the yellow LED changes status again and illuminates.

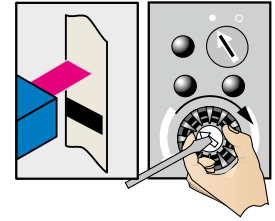

Turn the potentiometer forward again by half the number of turns to ensure that the switching threshold is optimally set.

Example

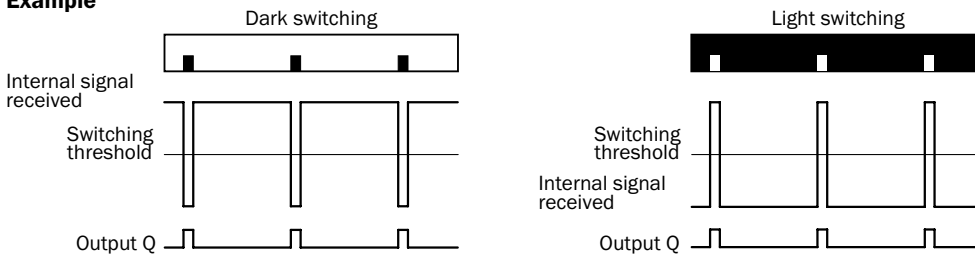

Switching characteristics

The switching threshold is set in the center between the background and the mark.

B

## KT5-2 Teach-in, teach-in static

### 1. Position mark

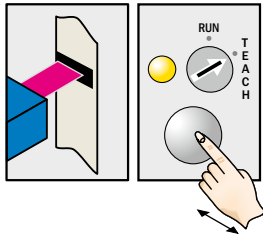

Turn rotary switch to "Teach" position. Press and hold teach-in button > 1 s. Red emitted light and yellow LED flash.

### 2. Position background

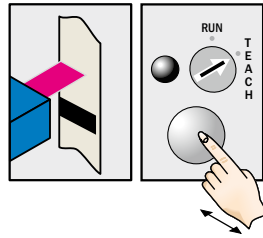

Press and hold teach-in button > 1 s. Yellow LED goes out.

### Example

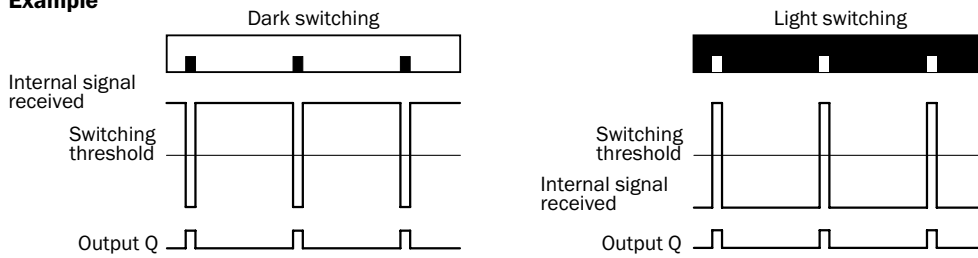

### Switching characteristics

The optimum emitted light is selected automatically.

Light/dark setting is defined using teach-in sequence.

The switching threshold is set in the center between the background and the mark.

Teach-in can also be performed using an external control signal.

**B**

**KT5-2 Teach-in, teach-in dynamic**

**B**

**1. Select switching function (light/dark)**

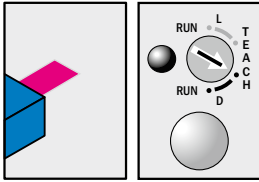

Turn rotary switch to desired teach position:  
D = dark switching  
L = light switching

**2. Position mark or background**

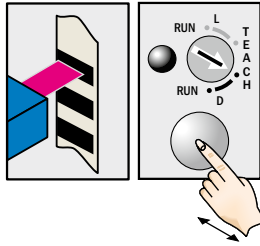

Press the teach-in button and keep it pressed.

**3. Move at least one repeat length using the light spot**

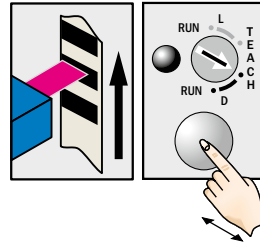

Keep the teach-in button pressed.

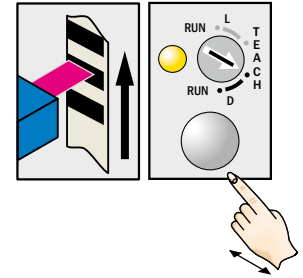

Release the teach-in button. Yellow LED will illuminate, when emitted light is on the mark.

**Example**

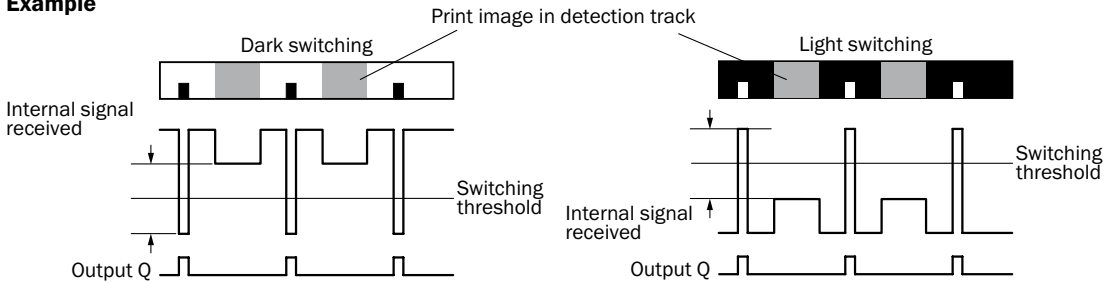

**Switching characteristics**

The optimum emitted light is selected automatically.  
The switching threshold is set in the center between the lowest and the second-lowest reflectivity.  
Teach-in can also be performed using an external control signal.  
Light/dark setting can also be configured using an external control signal.  
Observe the minimum speed (25 mm/s ... 300 mm/s).

## KT5-2 Display, Teach-in static

### 1. Position mark

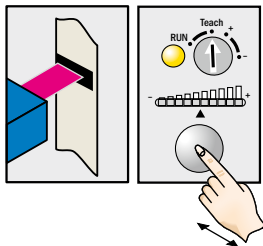

Turn rotary switch to "Teach" position. Press and hold teach-in button > 1 s. Red emitted light and yellow LED flash.

### 2. Position background

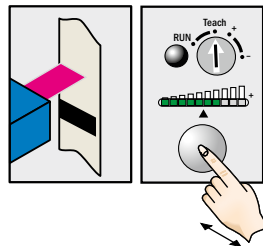

Press and hold teach-in button > 1 s. Yellow LED goes out. Optimum emitted light is selected.

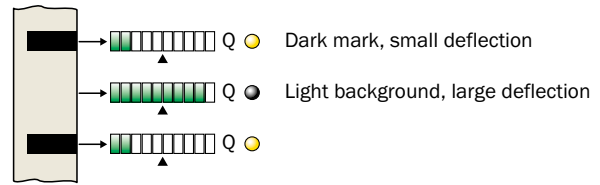

Fine adjustment possible using the "+" / "-" buttons.

### Note

The bar display visualizes the detection reliability during teach-in. The more LEDs that illuminate, the better the teach-in:

- 1 LED illuminates = operation not reliable – contrast difference too low
- ≤ 4 LEDs illuminate = operation OK – sufficient contrast difference
- > 4 LEDs illuminate = reliable operation – high contrast difference

### Example

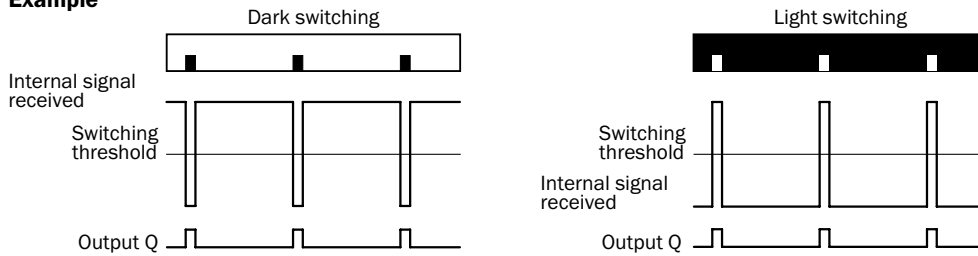

### Switching characteristics

The optimum emitted light is selected automatically. Light/dark setting is defined using teach-in sequence. The switching threshold is set in the center between the background and the mark. Teach-in can also be performed using an external control signal.







Recommended accessories

Lens and accessories

B

Description	Diameter	Type	Part no.
Lens, 40 mm sensing distance	26 mm	OBJ-210	2010945
Lens, 10 mm sensing distance	25.6 mm	OBJ-211	1004936
Lens, 20 mm sensing distance	25.6 mm	OBJ-212	1011506



Universal bar clamp systems

Figure	Material	Description	Type	Part no.
	Steel, zinc coated	Plate G for universal clamp bracket	BEF-KHS-G01	2022464
		Plate K for universal clamp bracket	BEF-KHS-K01	2022718
		Universal clamp bracket for rod mounting	BEF-KHS-KH1	2022726
		Mounting bar, straight, 200 mm, steel	BEF-MS12G-A	4056054
		Mounting bar, straight, 300 mm, steel	BEF-MS12G-B	4056055
		Mounting bar, L-shaped, 150 mm x 150 mm, steel	BEF-MS12L-A	4056052
		Mounting bar, L-shaped, 250 x 250 mm, steel	BEF-MS12L-B	4056053



Plug connectors and cables

Connecting cables with female connector

M12, 4-pin, PVC, chemical resistant

Figure	Connection type head A	Connection type head B	Connecting cable	Type	Part no.
	Female connector, M12, 4-pin, straight, unshielded	Cable, open conductor heads	2 m, 4-wire	DOL-1204-G02M	6009382
			5 m, 4-wire	DOL-1204-G05M	6009866
	Female connector, M12, 4-pin, angled, unshielded	Cable, open conductor heads	2 m, 4-wire	DOL-1204-W02M	6009383
			5 m, 4-wire	DOL-1204-W05M	6009867

M12, 5-pin, PVC, chemical resistant

Figure	Connection type head A	Connection type head B	Connecting cable	Type	Part no.
	Female connector, M12, 5-pin, straight, unshielded	Cable, open conductor heads	2 m, 5-wire	DOL-1205-G02M	6008899
			5 m, 5-wire	DOL-1205-G05M	6009868
	Female connector, M12, 5-pin, angled, unshielded	Cable, open conductor heads	2 m, 5-wire	DOL-1205-W02M	6008900
			5 m, 5-wire	DOL-1205-W05M	6009869

→ For additional accessories, please see page K-240





## CONTRAST SENSORS WITH FIBER-OPTIC CABLES

B



### Product description

When steam, heat or dust are present, the KTL5-2 family of contrast sensors with fiber-optic cables offers the ideal solution. Various straight or angled fiber-optics can be easily mounted on the sensor. Due to the 3-color RGB LED technology, the sensors are able to activate the best possible emitted light source for each contrast. In addition, the sensors feature application-specific teach-in processes. The sensor defines all necessary parameters automatically

– either via the teach-in button on the device or via an external control cable. The sensor then determines the ideal switching threshold from the two gray values detected. High-precision contrast detection, automatic adaptation for high-gloss objects, a 10 kHz switching frequency, analog output, and individual alignment and mounting options make the device suitable for a wide range of tasks.

### At a glance

- Various heat-resistant fiber-optic cable models are available
- Various teach-in methods, including potentiometer
- Analog output
- Switching frequency of 10 kHz

### Your benefits

- Reliable contrast detection
- Flexible integration into machines due to minimal space requirements and various fiber-optic cable versions
- Durable, glass fiber-optic cables
- Reliable operation in adverse environmental conditions, such as extreme temperatures and moisture
- Resistant to aggressive cleaning agents
- Compact design fits in applications with limited space

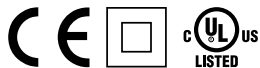

### Additional information

Detailed technical data . . . . .B-59  
 Ordering information . . . . .B-60  
 Dimensional drawing . . . . .B-60  
 Adjustments . . . . .B-61  
 Connection diagram. . . . .B-61  
 Sensing distance . . . . .B-61  
 Setting the switching threshold . .B-62  
 Recommended accessories . . . .B-64

→ [www.sick.com/de/en/KT5](http://www.sick.com/de/en/KT5)

For more information, just enter the link or scan the QR code and get direct access to technical data, CAD design models, operating instructions, software, application examples and much more.



## Detailed technical data

### Features

<b>Dimensions (W x H x D)</b>	30.4 mm x 53 mm x 80 mm
<b>Sensing distance</b>	Dependent on the fiber-optic cable
<b>Housing design (light emission)</b>	Rectangular
<b>Light source <sup>1)</sup></b>	LED
<b>Type of light</b>	Green, RGB (depending on type)
<b>Output function</b>	Light/dark switching

<sup>1)</sup> Average service life: 100,000 h at  $T_U = +25\text{ °C}$ .

### Mechanics/electronics

<b>Supply voltage <sup>1)</sup></b>	10 V DC ... 30 V DC
<b>Ripple <sup>2)</sup></b>	$\leq 5 V_{pp}$
<b>Power consumption <sup>3)</sup></b>	< 80 mA
<b>Switching frequency <sup>4)</sup></b>	10 kHz
<b>Response time <sup>5)</sup></b>	50 $\mu$ s
<b>Switching output</b>	PNP: HIGH = $V_S - \leq 2\text{ V}$ / LOW approx. 0 V / NPN: HIGH = approx. $V_S$ / LOW $\leq 2\text{ V}$ ,
<b>Output type</b>	PNP / NPN (depending on type)
<b>Analog output <math>Q_A</math></b>	0.3 mA ... 10 mA
<b>Output current <math>I_{max}</math></b>	100 mA
<b>Input, teach-in (ET)</b>	PNP: Teach: $U = 10\text{ V} \dots < U_V$ ; Run: $U < 2\text{ V}$ NPN: Teach: $U < 2\text{ V}$ ; Run: $U = 10\text{ V} \dots < U_V$
<b>Input, fine/coarse (F/C)</b>	PNP: fine: $U = 0\text{ V}$ ; Coarse: $U > 10\text{ V} \dots < U_V$
<b>Input, light/dark (L/D)</b>	PNP / light: $U = 0\text{ V}$ ; dark: $U > 10\text{ V} \dots < U_V$ NPN: light: $U = U_V$ ; dark: $U = 0\text{ V}$ (depending on type)
<b>Retention time (ET)</b>	25 ms, non-volatile memory
<b>Time delay</b>	20 ms
<b>Connection type</b>	Connector M12, 4-pin / Connector M12, 5-pin (depending on type)
<b>Protection class <sup>6)</sup></b>	II
<b>Circuit protection</b>	$V_S$ connections reverse-polarity protected, Output Q short-circuit protected, Interference suppression
<b>Enclosure rating</b>	IP 67
<b>Weight</b>	400 g
<b>Housing material</b>	Metal, zinc diecast

<sup>1)</sup> Limit values; operation in short-circuit protected network max. 8 A.

<sup>2)</sup> May not exceed or fall below  $U_V$  tolerances.

<sup>3)</sup> Without load.

<sup>4)</sup> With light/dark ratio 1:1.

<sup>5)</sup> Signal transit time with resistive load.

<sup>6)</sup> Reference voltage DC 50 V.

### Ambient data

<b>Ambient operating temperature</b>	-10 °C ... +55 °C
<b>Ambient storage temperature</b>	-25 °C ... +75 °C
<b>Shock load</b>	According to IEC 60068
<b>UL File No.</b>	NRKH.E181493 & NRKH7.E181493

## Ordering information

Other models → [www.sick.com/de/en/KT5](http://www.sick.com/de/en/KT5)

### KTL5-2 Fiber Optic

- **Sensing distance:** Dependent on the fiber-optic cable
- **Light spot size:** Dependent on the fiber-optic cable

**B**

Type of light	Wave length	Adjustment	Output type	Time delay	Analog output	Connection diagram	Type	Part no.
Green	520 nm	Manual adjustment, potentiometer	PNP	-	-	Cd-327	KTL5G-2P11	1016294
				0.3 mA ... 10 mA	Cd-327	KTL5G-2P51	1016950	
			NPN	-	-	Cd-327	KTL5G-2N11	1016295
				0.3 mA ... 10 mA	Cd-327	KTL5G-2N51	1016951	
		Without, automatic contrast detection	NPN	-	-	Cd-325	KTL5G-2P14	1022091
				20 ms	-	Cd-325	KTL5G-2P24	1019162
RGB	640 nm, 525 nm, 470 nm	Dynamic teach-in	PNP	-	-	Cd-324	KTL5W-2P13	1027562
				20 ms	-	Cd-324	KTL5W-2P23	1019551
			NPN	-	-	Cd-324	KTL5W-2N13	1019661
				-	-	Cd-323	KTL5W-2P16	1026006
		Static 2-point teach-in	PNP	-	-	Cd-323	KTL5W-2N16	1025995
				-	-	Cd-323	KTL5W-2N16	1025995

## Dimensional drawing (Dimensions in mm (inch))

### KTL5-2 Fiber Optic

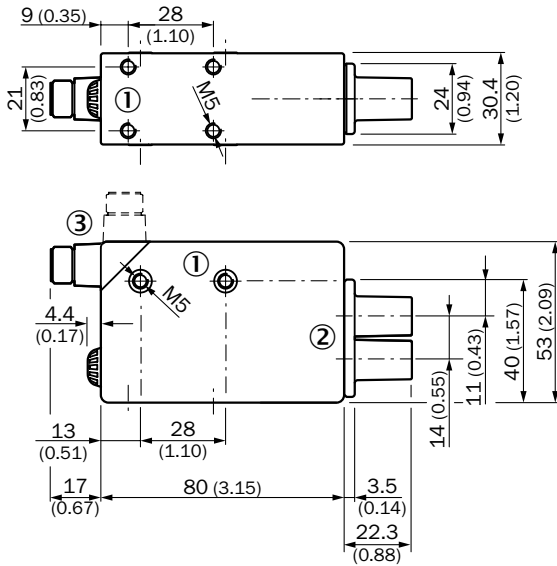

- ① M5 threaded mounting hole, 5.5 mm deep
- ② Fiber-optic adapter (M12 x 1 internal thread)
- ③ Connector M12 (rotatable up to 90°)

**Adjustments**

KTL5-2 Fiber Optic, KTL5G-xxx1

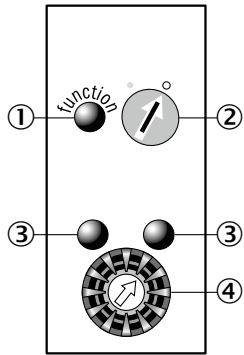

- ① Function signal indicator (yellow)
- ② Pre-selection switch (light/dark switching)
- ③ Adjustment indicators (green)
- ④ Switching threshold adjustment

KTL5-2 Fiber Optic, KTL5G-xxx4

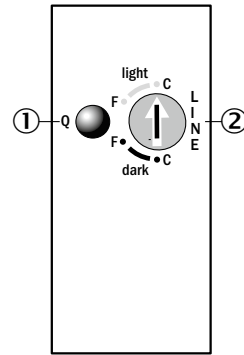

- ① Function signal indicator (yellow)
- ② Fine/coarse switch

KTL5-2 Fiber Optic, KTL5W-xxx3

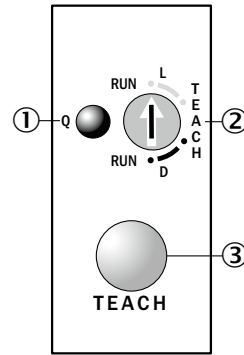

- ① Function signal indicator (yellow)
- ② Pre-selection switch (light/dark switching)
- ③ Teach-in button

KTL5-2 Fiber Optic, KTL5W-xxx6

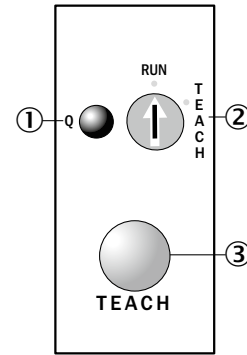

- ① Function signal indicator (yellow)
- ② Pre-selection switch
- ③ Teach-in button

**B**

**Connection diagram**

Cd-323

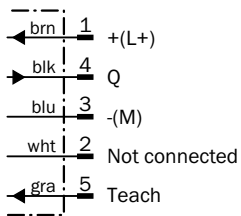

Cd-324

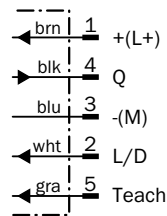

Cd-325

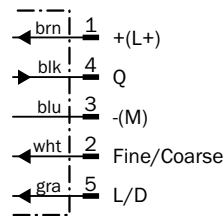

Cd-327

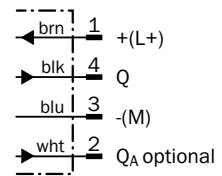

**Sensing distance**

KTL5-2 Fiber Optic

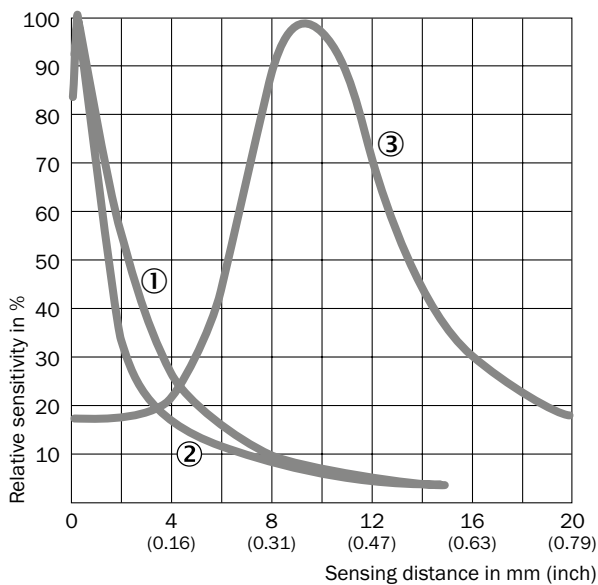

- ① Fiber-optic cable LBST 32900
- ② Fiber-optic cable LBSR 32900
- ③ Fiber-optic cable OCSL

Setting the switching threshold

Potentiometer

B

1. Select switching function (light/dark)

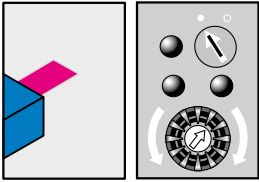

Turn the rotary switch to the desired position:  
 ○ = light switching  
 ● = dark switching

2. Position mark

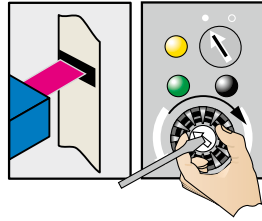

Turn potentiometer in the direction shown (green LED illuminates) until the yellow LED status changes and the green LED opposite illuminates.

3. Position background

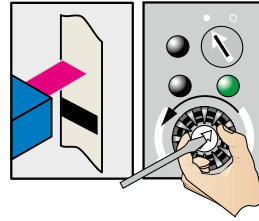

Gradually turn back the potentiometer (count the number of turns) until the yellow LED changes status again and illuminates.

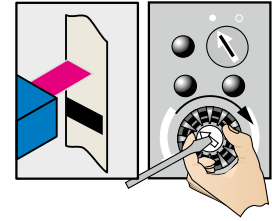

Turn the potentiometer forward again by half the number of turns to ensure that the switching threshold is optimally set.

Switching characteristics

The optimum emitted light is selected automatically.  
 The switching threshold is set in the center between the background and the mark.

Teach-in dynamic

1. Select switching function (light/dark)

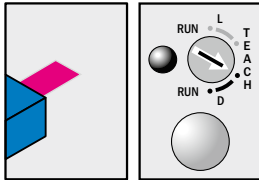

Turn the rotary switch to the desired teach position:  
 D = dark switching  
 L = light switching

2. Position mark or background

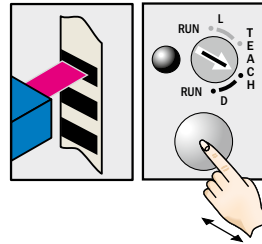

Press the teach-in button and keep it pressed.

3. Move at least one repeat length using the light spot

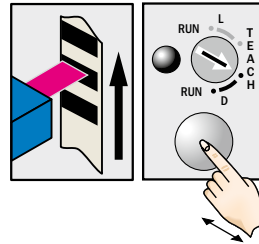

Keep the teach-in button pressed.

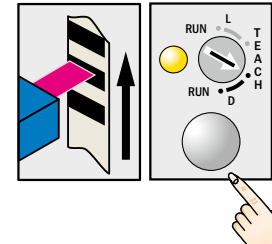

Release the teach-in button. Yellow LED will illuminate, when emitted light is on the mark.

Example

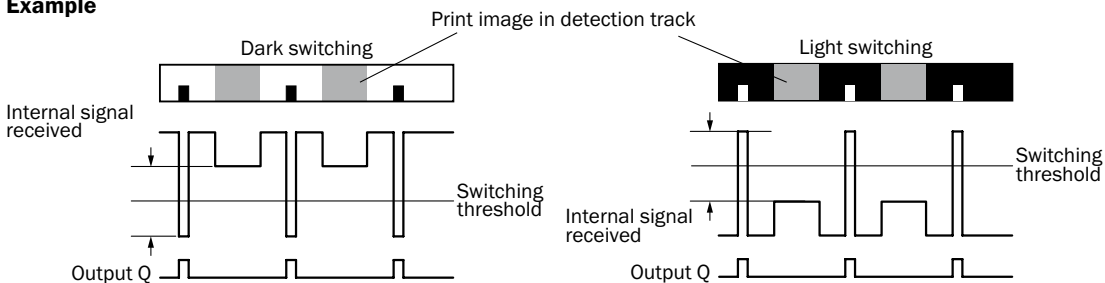

Switching characteristics

The optimum emitted light is selected automatically.  
 The switching threshold is set in the center between the lowest and the second-lowest reflectivity.  
 Teach-in can also be performed using an external control signal.  
 Light/dark setting can also be configured using an external control signal.  
 Observe the minimum speed (25 mm/s ... 300 mm/s).

## Teach-in static

### 1. Position mark

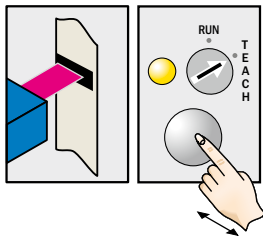

Turn rotary switch to "Teach" position. Press and hold teach-in button > 1 s. Red emitted light and yellow LED flash.

### 2. Position background

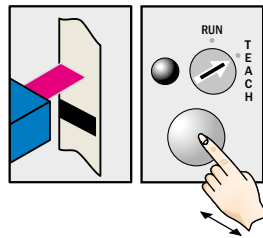

Press and hold teach-in button > 1 s. Yellow LED goes out.

### Example (for both settings)

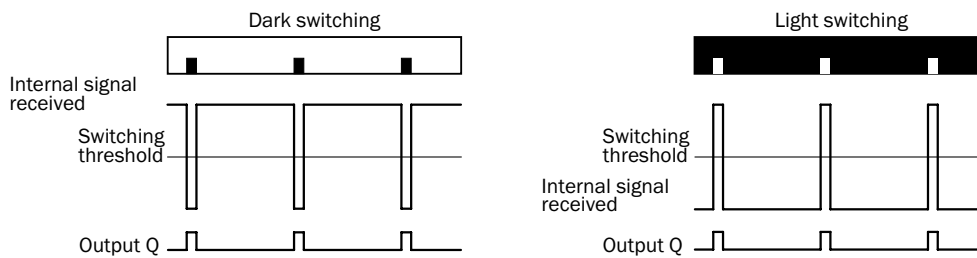

### Switching characteristics

The optimum emitted light is selected automatically.  
 Light/dark setting is defined using teach-in sequence.  
 The switching threshold is set in the center between the background and the mark.  
 Teach-in can also be performed using an external control signal.

**B**









Recommended accessories

Others

Description	Core material	Fiber length	Minimum bend radius	Detection principle	Type	Part no.
Fiber optic, bifurcated, thread/angle tip, 3.2 mm bundle, glass/stainless steel	Glass fiber	5 m	19 mm	Proximity system	LBSTA325000	7022348



Universal bar clamp systems

Figure	Material	Description	Type	Part no.
	Steel, zinc coated	Plate G for universal clamp bracket	BEF-KHS-G01	2022464
		Plate K for universal clamp bracket	BEF-KHS-K01	2022718
		Universal clamp bracket for rod mounting	BEF-KHS-KH1	2022726
		Mounting bar, straight, 200 mm, steel	BEF-MS12G-A	4056054
		Mounting bar, straight, 300 mm, steel	BEF-MS12G-B	4056055
		Mounting bar, L-shaped, 150 mm x 150 mm, steel	BEF-MS12L-A	4056052
		Mounting bar, L-shaped, 250 x 250 mm, steel	BEF-MS12L-B	4056053



Plug connectors and cables

Connecting cables with female connector

M12, 4-pin, PVC, chemical resistant

Figure	Connection type head A	Connection type head B	Connecting cable	Type	Part no.
	Female connector, M12, 4-pin, straight, unshielded	Cable, open conductor heads	2 m, 4-wire	DOL-1204-G02M	6009382
			5 m, 4-wire	DOL-1204-G05M	6009866
	Female connector, M12, 4-pin, angled, unshielded	Cable, open conductor heads	2 m, 4-wire	DOL-1204-W02M	6009383
			5 m, 4-wire	DOL-1204-W05M	6009867

M12, 5-pin, PVC, chemical resistant

Figure	Connection type head A	Connection type head B	Connecting cable	Type	Part no.
	Female connector, M12, 5-pin, straight, unshielded	Cable, open conductor heads	2 m, 5-wire	DOL-1205-G02M	6008899
			5 m, 5-wire	DOL-1205-G05M	6009868
	Female connector, M12, 5-pin, angled, unshielded	Cable, open conductor heads	2 m, 5-wire	DOL-1205-W02M	6008900
			5 m, 5-wire	DOL-1205-W05M	6009869

→ For additional accessories, please see page K-240



## EASY CONTRAST DETECTION

B

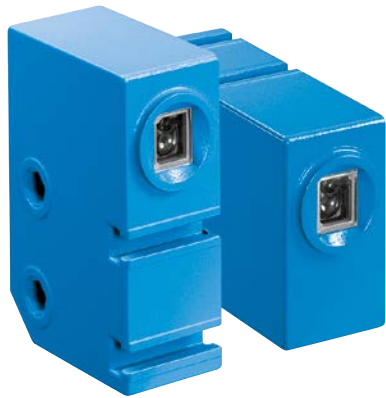

### Product description

The KT6W-2 is a high-performance, cost-competitive contrast sensor with easy setup. The 3-color RGB LED technology allows even the smallest marks and contrasts to be reliably detected. High-gloss reflective marks are also detected due to the sensor's automatic gloss adjustment feature. A tough, metal housing ensures a long service life and high quality. The teach-in process is sim-

ple and easy all key parameters, such as transmission color and light/dark switching are detected automatically by the sensor. The KT6W-2 is available with the light emission located on the side of the device or on the end of the device. In addition to sturdy fixing holes, the KT6W-2 features two additional t-slots for even more mounting flexibility.

### At a glance

- 3-color RGB LED technology
- 2-point teach-in (mark and background)
- Tough, metal housing
- Automatic gloss adjustment for highly reflective materials
- 10 mm sensing distance
- Light exits at end or side, based on model
- Common mounting footprint

### Your benefits

- 3-color RGB LED for all registration mark applications – one sensor fits all
- Tough, metal housing for long service life
- Reliable operation, even with high-gloss reflective and jittering materials
- Easy setup – detect all marks with one sensor



### Additional information

Detailed technical data . . . . . B-67  
 Ordering information . . . . . B-68  
 Dimensional drawings . . . . . B-68  
 Adjustments . . . . . B-69  
 Connection diagram . . . . . B-69  
 Sensing distance . . . . . B-69  
 Setting the switching threshold . . B-70  
 Recommended accessories . . . . B-71

→ [www.sick.com/de/en/KT6](http://www.sick.com/de/en/KT6)

For more information, just enter the link or scan the QR code and get direct access to technical data, CAD design models, operating instructions, software, application examples and much more.



## Detailed technical data

### Features

<b>Dimensions (W x H x D)</b>	30.4 mm x 53 mm x 80 mm
<b>Sensing distance</b>	10 mm
<b>Housing design (light emission)</b>	Rectangular
<b>Sensing distance tolerance</b>	± 3 mm
<b>Light source <sup>1)</sup></b>	LED
<b>Type of light</b>	RGB
<b>Light emission</b>	Short side of housing / Long side of housing (depending on type)
<b>Light spot size</b>	1.5 mm x 6.5 mm
<b>Light spot direction <sup>2)</sup></b>	Vertical
<b>Teach-in mode</b>	Static 2-point teach-in

<sup>1)</sup> Average service life: 100,000 h at  $T_U = +25\text{ °C}$ .

<sup>2)</sup> In relation to long side of housing.

### Mechanics/electronics

<b>Supply voltage <sup>1)</sup></b>	10 V DC ... 30 V DC
<b>Ripple <sup>2)</sup></b>	≤ 5 V <sub>pp</sub>
<b>Power consumption <sup>3)</sup></b>	< 40 mA
<b>Switching frequency <sup>4)</sup></b>	5 kHz
<b>Response time</b>	100 μs
<b>Switching output</b>	PNP: HIGH = $V_S - \leq 2\text{ V}$ / LOW approx. 0 V / NPN: HIGH = approx. $V_S$ / LOW ≤ 2 V,
<b>Output type</b>	PNP / NPN
<b>Output current I<sub>max.</sub></b>	100 mA
<b>Retention time (ET)</b>	25 ms, non-volatile memory
<b>Connection type</b>	Connector M12, 4-pin
<b>Protection class <sup>5)</sup></b>	II
<b>Circuit protection</b>	$V_S$ connections reverse-polarity protected, Output Q short-circuit protected, Interference suppression
<b>Enclosure rating</b>	IP 67
<b>Weight</b>	400 g
<b>Housing material</b>	Metal, zinc diecast

<sup>1)</sup> Limit values; operation in short-circuit protected network max. 8 A.

<sup>2)</sup> May not exceed or fall below  $U_v$  tolerances.

<sup>3)</sup> Without load.

<sup>4)</sup> With light/dark ratio 1:1.

<sup>5)</sup> Reference voltage DC 50 V.

### Ambient data

<b>Ambient operating temperature</b>	-10 °C ... +55 °C
<b>Ambient storage temperature</b>	-25 °C ... +75 °C
<b>Shock load</b>	According to IEC 60068

Ordering information

Other models → [www.sick.com/de/en/KT6](http://www.sick.com/de/en/KT6)

B

Light emission	Output type	Type	Part no.
Short side of housing	PNP	KT6W-2P5116	1046013
	NPN	KT6W-2N5116	1046010
Long side of housing	PNP	KT6W-2P6116	1046014
	NPN	KT6W-2N6116	1046012

Dimensional drawings (Dimensions in mm (inch))

KT6W-2x5xxx

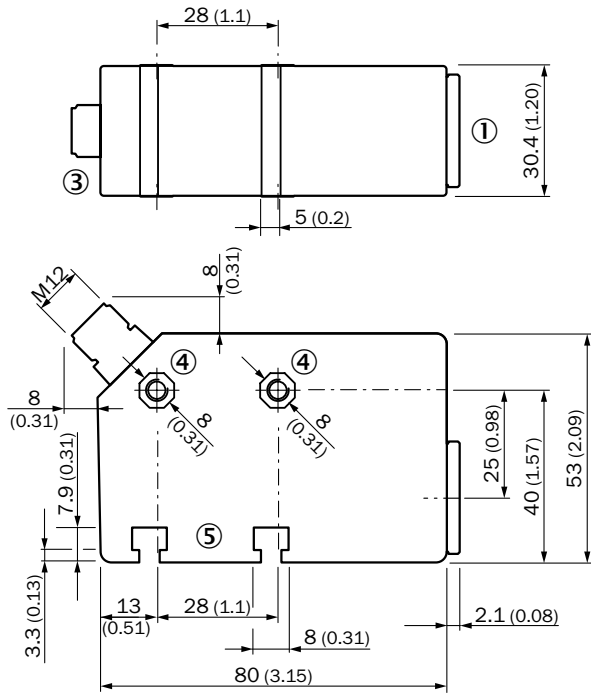

- ① Lens (light transmission), edge side
- ③ Connector M12
- ④ SW8 mounting hole for M5 nut
- ⑤ SW8 T-slot for M5 nut

KT6W-2x6xxx

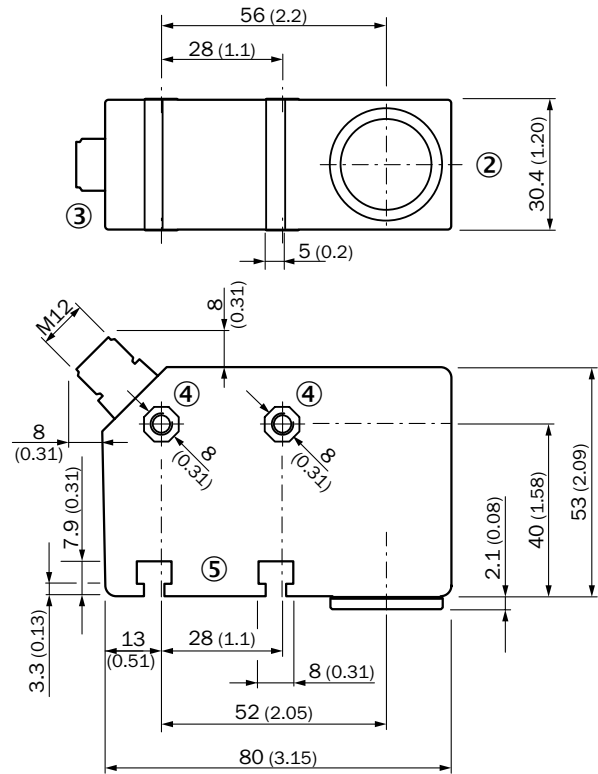

- ② Lens (light transmission), length side
- ③ Connector M12
- ④ SW8 mounting hole for M5 nut
- ⑤ SW8 T-slot for M5 nut

### Adjustments

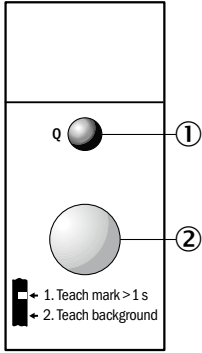

- ① Function signal indicator
- ② Teach-in button

### Connection diagram

Cd-066

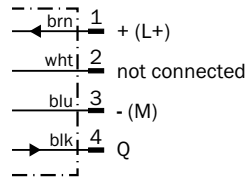

**B**

### Sensing distance

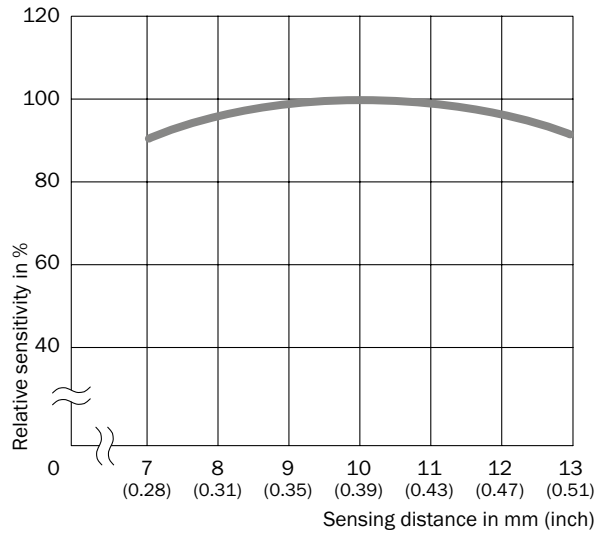



Setting the switching threshold

Teach-in static

1. Position mark

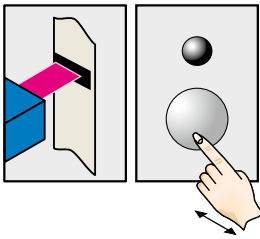

Press and hold teach-in button > 1 s.  
Red emitted light flashes.

2. Position background

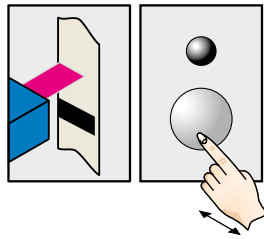

Press and hold teach-in button > 1 s.  
Yellow LED will illuminate, when emitted light is on the mark.

Example

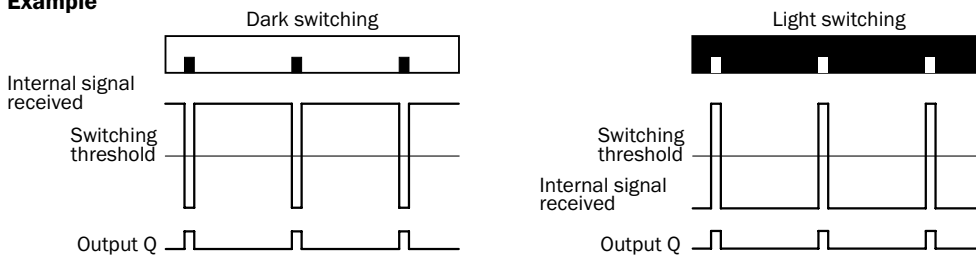







Switching characteristics

The optimum emitted light is selected automatically.  
Light/dark setting is defined using teach-in sequence.  
The switching threshold is set in the center between the background and the mark.

B

Recommended accessories

Universal bar clamp systems



Figure	Material	Description	Type	Part no.
	Steel, zinc coated	Plate K for universal clamp bracket	BEF-KHS-K01	2022718
		Universal clamp bracket for rod mounting	BEF-KHS-KH1	2022726
		Mounting bar, straight, 200 mm, steel	BEF-MS12G-A	4056054
		Mounting bar, straight, 300 mm, steel	BEF-MS12G-B	4056055
		Mounting bar, L-shaped, 150 mm x 150 mm, steel	BEF-MS12L-A	4056052
		Mounting bar, L-shaped, 250 x 250 mm, steel	BEF-MS12L-B	4056053

**B**

Plug connectors and cables

Connecting cables with female connector

M12, 4-pin, PVC, chemical resistant

Figure	Connection type head A	Connection type head B	Connecting cable	Type	Part no.
	Female connector, M12, 4-pin, straight, unshielded	Cable, open conductor heads	2 m, 4-wire	DOL-1204-G02M	6009382
			5 m, 4-wire	DOL-1204-G05M	6009866
	Female connector, M12, 4-pin, angled, unshielded	Cable, open conductor heads	2 m, 4-wire	DOL-1204-W02M	6009383
			5 m, 4-wire	DOL-1204-W05M	6009867

→ For additional accessories, please see page K-240

# LASER CONTRAST SENSOR AND CAN COMMUNICATION

B

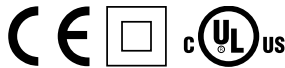

### Additional information

Detailed technical data . . . . . B-73  
 Ordering information . . . . . B-74  
 Dimensional drawings . . . . . B-74  
 Adjustments . . . . . B-75  
 Connection diagram . . . . . B-75  
 Sensing distance . . . . . B-76  
 Setting the switching threshold . . B-76  
 Recommended accessories . . . . B-78

### Product description

The KT8 contrast sensor family has two versions. The first variant, KT8L, allows a highly reliable detection of the smallest contrast marks and objects thanks to the precise laser. Lasers are used in contrast sensors for either long-range detection (800 mm) or detection of very small objects. The KT8L provides both. Two light spot sizes are available: <0.3 mm for detecting small objects and marks and 3 mm for larger objects and marks. The second variant, KT8 CAN, is distinguished primarily by its ability to

communicate. The CAN interface makes adjusting the sensor and integrating additional functions into a machine easier. Any number of parameter sets can be stored in the machine controller via the CAN interface, such as for different packaging. In addition, important process data, like contamination or current switching thresholds can be queried via the CAN interface. A 3-color LED, gloss adaptation, automatic drift correction and fast response times are also included.

### At a glance

- Laser version offers sensing distances of 30 mm to 800 mm
- Very small and precise laser light spot (Class II)
- Fast switching frequency of 17 kHz
- Detection reliability displayed in the bar graph display
- CAN interface version for parameter setup, diagnostics and function selection
- Very precise light spot

### Your benefits

- Wide selection of varying distances, depending on the application
- Precise detection of the smallest marks and objects, e.g., 1 x 1 mm<sup>2</sup>
- Reliable operation, even with unsteady objects
- Easy integration into machine designs, thanks to standard CAN protocol
- Access to the sensor via the control system saves the machine operator time and effort during configuration
- Individual, application-specific configuration and settings
- Automatic drift correction ensures high production reliability with faded print marks and other difficult to detect marks
- Reliable operation, even with high-gloss reflective surfaces, increasing throughput

→ [www.mysick.com/en/KT8](http://www.mysick.com/en/KT8)

For more information, just enter the link or scan the QR code and get direct access to technical data, CAD design models, operating instructions, software, application examples and much more.



## Detailed technical data

## Features

	KT8 CAN	KT8L Laser
<b>Dimensions (W x H x D)</b>	30.4 mm x 53 mm x 80 mm	
<b>Sensing distance <sup>1)</sup></b>	10 mm / 20 mm (depending on type)	150 mm
<b>Housing design (light emission)</b>	Rectangular	
<b>Light source</b>	LED <sup>2)</sup>	Laser <sup>3)</sup>
<b>Type of light</b>	RGB	Red
<b>Wave length</b>	640 nm, 525 nm, 470 nm	655 nm
<b>Light emission</b>	Long and short side of housing, exchangeable	Long side of housing
<b>Light spot direction</b>	Vertical <sup>4)</sup>	Round
<b>Operating distance</b>	-	30 mm ... 800 mm <sup>5)</sup> (depending on type)
<b>Teach-in mode</b>	Static 2-point teach-in, Dynamic teach-in (min/max)	
<b>Function</b>	Automatic drift correction, Deactivation delay, 10 ms / 20 ms / 40 ms, adjustable, CAN interface	Automatic drift correction

<sup>1)</sup> From front edge of lens.

<sup>2)</sup> Average service life: 100,000 h at  $T_U = +25$  °C.

<sup>3)</sup> Average service life 50,000 h at  $T_A = +25$  °C.

<sup>4)</sup> In relation to long side of housing.

<sup>5)</sup> With respect to black-white contrast 6 % / 90 %.

## Mechanics/electronics

	KT8 CAN	KT8L Laser
<b>Supply voltage <sup>1)</sup></b>	10 V DC ... 30 V DC	
<b>Ripple <sup>2)</sup></b>	$\leq 5 V_{pp}$	
<b>Power consumption <sup>3)</sup></b>	< 120 mA	< 80 mA
<b>Switching frequency <sup>4)</sup></b>	22.5 kHz	17 kHz
<b>Response time <sup>5)</sup></b>	22 $\mu$ s	30 $\mu$ s
<b>Jitter</b>	< 11 $\mu$ s	< 15 $\mu$ s
<b>Switching output</b>	PNP: HIGH = $V_S - \leq 2 V$ / LOW approx. 0 V NPN: HIGH = approx. $V_S$ / LOW $\leq 2 V$ ,	
<b>Analog output <math>Q_A</math></b>	-	0.3 mA ... 28.5 mA
<b>Output current <math>I_{max.}</math></b>	100 mA	
<b>Input, teach-in (ET)</b>	PNP: Teach: $U = 10 V \dots < U_V$ ; Run: $U < 2 V$ NPN: Teach: $U < 2 V$ ; Run: $U = 10 V \dots < U_V$	
<b>Retention time (ET)</b>	25 ms, non-volatile memory	
<b>Time delay</b>	-	20 ms, adjustable
<b>Connection type</b>	Male connector M12, 8-pin	Connector M12, 5-pin
<b>Protection class</b>	II <sup>6)</sup>	II <sup>7)</sup>
<b>Circuit protection</b>	$V_S$ connections reverse-polarity protected, Output Q short-circuit protected, Interference suppression	
<b>Enclosure rating</b>	IP 67	
<b>Weight</b>	400 g	
<b>Housing material</b>	Metal, zinc diecast	

<sup>1)</sup> Limit values; operation in short-circuit protected network max. 8 A.

<sup>2)</sup> May not exceed or fall below  $U_V$  tolerances.

<sup>3)</sup> Without load.

<sup>4)</sup> With light/dark ratio 1:1.

<sup>5)</sup> Signal transit time with resistive load.

<sup>6)</sup> Reference voltage DC 32 V.

<sup>7)</sup> Reference voltage DC 50 V.

Ambient data

	KT8 CAN	KT8L Laser
Ambient operating temperature	-10 °C ... +55 °C	-10 °C ... +45 °C
Ambient storage temperature	-10 °C ... +75 °C	
Shock load	According to IEC 60068	
UL File No.	NRKH.E181493 & NRKH7.E181493	242368, CDRH-conform

B

Ordering information

Other models → [www.mysick.com/en/KT8](http://www.mysick.com/en/KT8)

KT8 CAN

Sensing distance <sup>1)</sup>	Sensing distance tolerance	Light spot size	Output type	Connection diagram	Type	Part no.
10 mm	± 3 mm	0.8 mm x 4 mm	PNP	Cd-328	KT8W-P111C	1027919
			NPN	Cd-328	KT8W-N111C	1028223
20 mm	± 3 mm	1.5 mm x 5.5 mm	PNP	Cd-328	KT8W-P121C	1043689

<sup>1)</sup> From front edge of lens.

KT8L Laser

Sensing distance <sup>1)</sup>	Operating distance <sup>2)</sup>	Light spot size <sup>3)</sup>	Output type	Connection diagram	Type	Part no.
150 mm	30 mm ... 800 mm	Ø 0.3 mm	PNP	Cd-329	KT8L-P3656	1041262
			NPN	Cd-329	KT8L-N3656	1041263
	30 mm ... 600 mm	Ø 3 mm	PNP	Cd-329	KT8L-P3756	1041351
			NPN	Cd-329	KT8L-N3756	1041352

<sup>1)</sup> From front edge of lens.

<sup>2)</sup> With respect to black-white contrast 6 % / 90 %.

<sup>3)</sup> At focal point = sensing distance 150 mm.

Dimensional drawings (Dimensions in mm (inch))

KT8 CAN

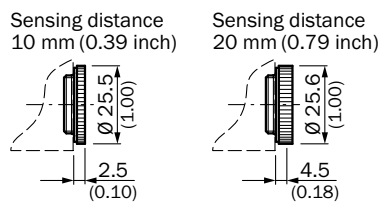
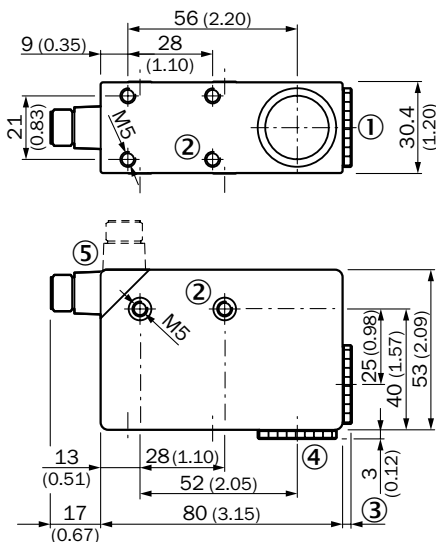

- ① Lens (light transmission), can be exchanged for pos. 4
- ② M5 threaded mounting hole, 5.5 mm deep
- ③ See dimensional drawing for lens
- ④ Blind screw can be replaced by pos. 1
- ⑤ Connector M12 (rotatable up to 90°)

KT8L Laser

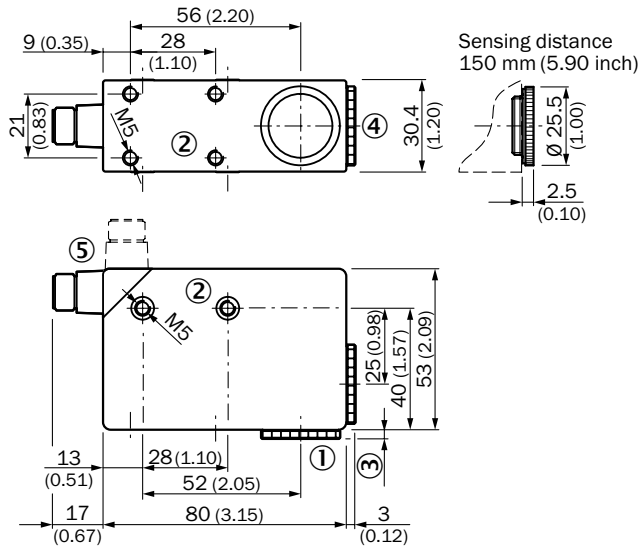

- ① Lens (light transmission), cannot be exchanged for pos. 4
- ② M5 threaded mounting hole, 5.5 mm deep
- ③ See dimensional drawing of lens
- ④ Blind screw cannot be replaced by pos. 1
- ⑤ Connector M12 (rotatable up to 90°)

**B**

Adjustments

KT8 CAN

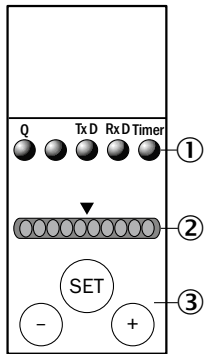

- ① Function signal indicators (yellow)
- ② Bar graph (green)
- ③ Teach-in button/"+" and "-" button

KT8L Laser

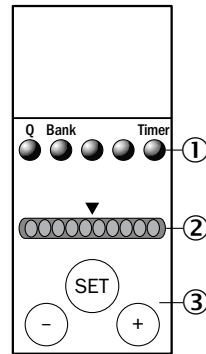

- ① Function signal indicators (yellow)
- ② Bar graph (green)
- ③ Teach-in button/"+" and "-" button

Connection diagram

Cd-328

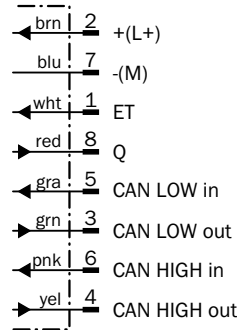

Cd-329

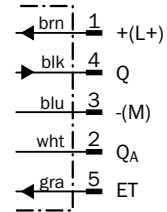



B

Sensing distance

KT8 CAN, KT10-2

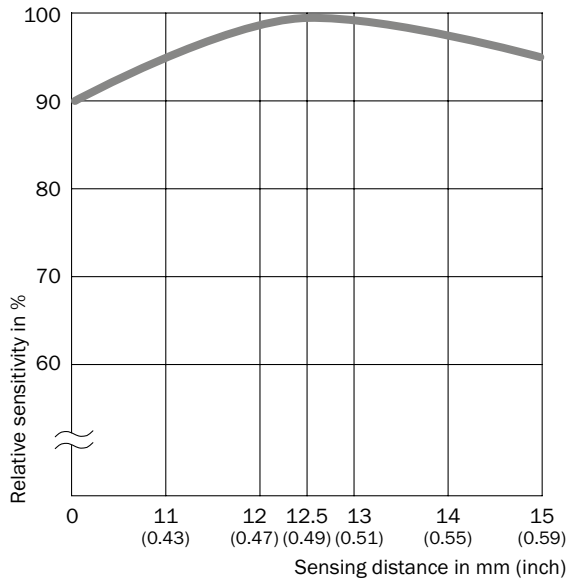

KT8L Laser

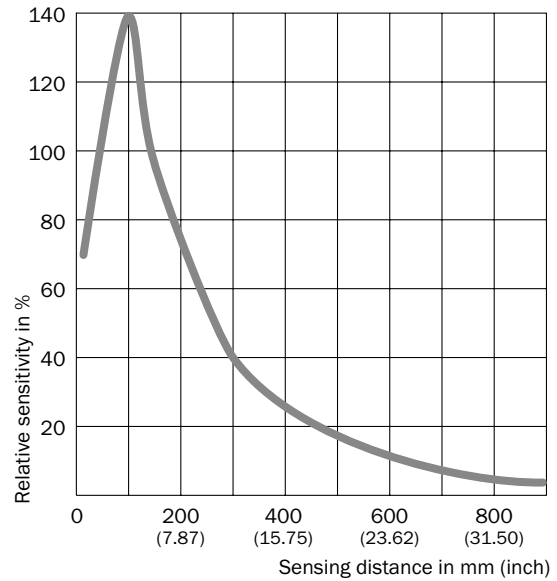

Setting the switching threshold

KT8, Teach-in static (default setting KT8 Laser)

1. Position mark

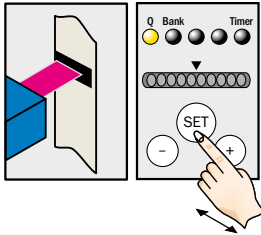

Press and hold SET button > 1 s.  
Yellow LED flashes.

2. Position background

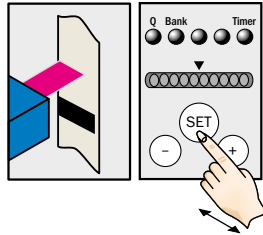

Press and hold SET button > 1 s.  
Yellow LED goes out.

**KT8, Teach-in dynamic (default setting KT8 CAN)**

**1. Position background**

**2. Move at least one repeat length using the light spot**

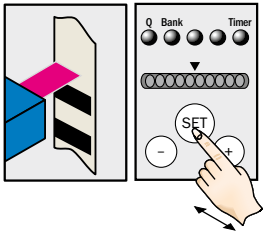

Press and hold SET button.  
Emitted light turns white.

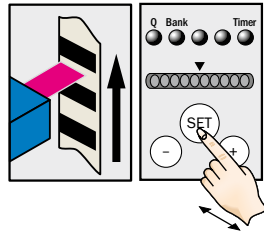

Hold down SET button.

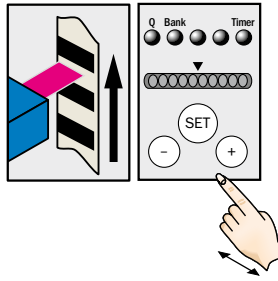

Release SET button.

**Note**

The bar display visualizes the detection reliability during teach-in. The more LEDs that illuminate, the better the teach-in:

- 1 LED illuminates = operation not reliable – contrast difference too low
- ≤ 4 LEDs illuminate = operation OK – sufficient contrast difference
- > 4 LEDs illuminate = reliable operation – high contrast difference

**Example**

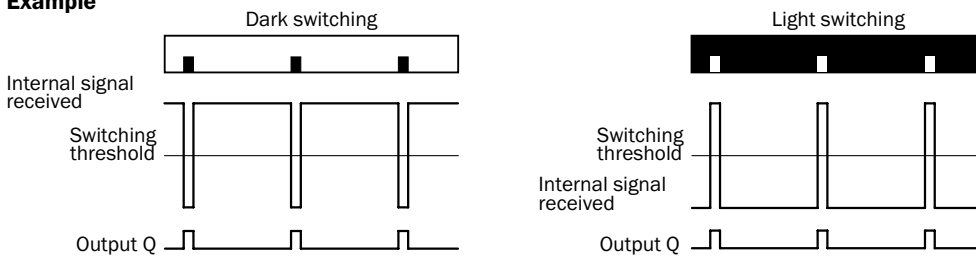

**Switching characteristics**







Light/dark setting is defined using teach-in sequence or menu, cf. operating instructions. The switching threshold is set in the center between the background and the mark. Teach-in and the light/dark setting can also be configured using an external control signal. Configuration only possible via CAN (see operating instruction).

**B**

Recommended accessories

Universal bar clamp systems



B

Figure	Material	Description	Type	Part no.
	Steel, zinc coated	Plate G for universal clamp bracket	BEF-KHS-G01	2022464
		Plate K for universal clamp bracket	BEF-KHS-K01	2022718
		Universal clamp bracket for rod mounting	BEF-KHS-KH1	2022726
		Mounting bar, straight, 200 mm, steel	BEF-MS12G-A	4056054
		Mounting bar, straight, 300 mm, steel	BEF-MS12G-B	4056055
		Mounting bar, L-shaped, 150 mm x 150 mm, steel	BEF-MS12L-A	4056052
		Mounting bar, L-shaped, 250 x 250 mm, steel	BEF-MS12L-B	4056053

Plug connectors and cables

Connecting cables with female connector

M12, 5-pin, PVC, chemical resistant

Figure	Connection type head A	Connection type head B	Connecting cable	Type	Part no.
	Female connector, M12, 5-pin, straight, unshielded	Cable, open conductor heads	2 m, 5-wire	DOL-1205-G02M	6008899
			5 m, 5-wire	DOL-1205-G05M	6009868
	Female connector, M12, 5-pin, angled, unshielded	Cable, open conductor heads	2 m, 5-wire	DOL-1205-W02M	6008900
			5 m, 5-wire	DOL-1205-W05M	6009869

M12, 8-pin, PUR, halogen-free

Figure	Connection type head A	Connection type head B	Connecting cable	Type	Part no.
	Female connector, M12, 8-pin, angled, shielded	Cable, open conductor heads	2 m, 8-wire	DOL-1208-W02MAS01	6029224

→ For additional accessories, please see page K-240



# THE INDUSTRY CHOICE FOR HIGH-SPEED AND PRECISION MARK DETECTION

B



## Product description

Extremely high speeds, poor contrasts and reflective materials are no problem for the KT10-2. Ease of use is the defining feature of the second generation of the KT10. Even during the teach-in phase, the sensor selects the transmission color that best matches the existing contrast. And, the sensor adjusts itself if marks need to be detected on glossy foils. In addition, the sensor compensates for dirt build-up on lenses using

automatic drift correction. The KT10-2 offers an exceptionally fast switching frequency, an easy-to-read bar graph display and 2 light exits. The bar graph display provides visible confirmation of the teach-in and can be used to monitor the sensor's status during operation. The sensor's two interchangeable light exits enable the KT10-2 to be mounted in more places.

## At a glance

- Very low jitter (< 10 µs)
- Precise light spot
- Best contrast resolution thanks to RGB LED technology
- Two interchangeable light exits
- Automatic drift correction
- Fast switching frequency of 25 kHz
- Easy-to-read bar graph display

## Your benefits

- Very precise detection of print marks enables optimal results for packaging and printing applications
- All contrast marks, even pale yellow on white paper, can be reliably detected thanks to RGB LED technology
- Automatic drift correction helps detect difficult to see marks, such as faded print marks, enabling higher production reliability
- Reliable operation, even with high-gloss reflective surfaces, increasing throughput
- Simple teach-in via an external signal can be performed while the material is moving, enabling shorter setup time
- Long-lasting, tough metal housing

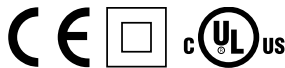

## Additional information

Detailed technical data . . . . .B-81  
 Ordering information . . . . .B-82  
 Dimensional drawing . . . . .B-82  
 Adjustments . . . . .B-82  
 Connection diagram. . . . .B-83  
 Sensing distance . . . . .B-83  
 Setting the switching threshold . .B-83  
 Recommended accessories . . . .B-85

→ [www.sick.com/de/en/KT10](http://www.sick.com/de/en/KT10)

For more information, just enter the link or scan the QR code and get direct access to technical data, CAD design models, operating instructions, software, application examples and much more.



## Detailed technical data

### Features

<b>Dimensions (W x H x D)</b>	30.4 mm x 53 mm x 80 mm
<b>Sensing distance <sup>1)</sup></b>	10 mm
<b>Housing design (light emission)</b>	Rectangular
<b>Sensing distance tolerance</b>	± 3 mm
<b>Light source <sup>2)</sup></b>	LED
<b>Type of light</b>	RGB
<b>Wave length</b>	640 nm, 525 nm, 470 nm
<b>Light emission</b>	Long and short side of housing, exchangeable
<b>Light spot size</b>	0.8 mm x 4 mm
<b>Light spot direction <sup>3)</sup></b>	Vertical / Horizontal (depending on type)
<b>Teach-in mode</b>	Static 2-point teach-in, Dynamic teach-in (min/max)
<b>Function</b>	Automatic drift correction

<sup>1)</sup> From front edge of lens.

<sup>2)</sup> Average service life: 100,000 h at  $T_U = +25\text{ °C}$ .

<sup>3)</sup> In relation to long side of housing.

### Mechanics/electronics

<b>Supply voltage <sup>1)</sup></b>	10 V DC ... 30 V DC
<b>Ripple <sup>2)</sup></b>	≤ 5 V <sub>pp</sub>
<b>Power consumption <sup>3)</sup></b>	< 120 mA
<b>Switching frequency <sup>4)</sup></b>	25 kHz
<b>Response time <sup>5)</sup></b>	20 μs
<b>Jitter</b>	< 10 μs
<b>Switching output</b>	PNP: HIGH = $V_S - \leq 2\text{ V}$ / LOW approx. 0 V / NPN: HIGH = approx. $V_S$ / LOW ≤ 2 V,
<b>Output type</b>	PNP / NPN (depending on type)
<b>Output current I<sub>max</sub></b>	100 mA
<b>Input, teach-in (ET)</b>	PNP: Teach: $U = 10\text{ V} \dots < U_V$ ; Run: $U < 2\text{ V}$ NPN: Teach: $U < 2\text{ V}$ ; Run: $U = 10\text{ V} \dots < U_V$
<b>Input, blanking input (AT)</b>	PNP: Blanked: $U > 10\text{ V} \dots < U_V$ ; Free-running: $U < 2\text{ V}$ <sup>6)</sup> NPN: Blanked: $U < 2\text{ V}$ ; Free-running: $U > 10\text{ V} \dots < U_V$ <sup>6)</sup>
<b>Retention time (ET)</b>	25 ms, non-volatile memory
<b>Time delay</b>	20 ms, adjustable
<b>Connection type</b>	Connector M12, 5-pin
<b>Protection class <sup>7)</sup></b>	II
<b>Circuit protection</b>	$V_S$ connections reverse-polarity protected, Output Q short-circuit protected, Interference suppression, Outputs overcurrent and short-circuit protected
<b>Enclosure rating</b>	IP 67
<b>Weight</b>	400 g
<b>Housing material</b>	Metal, zinc diecast

<sup>1)</sup> Limit values; operation in short-circuit protected network max. 8 A.

<sup>2)</sup> May not exceed or fall below  $U_V$  tolerances.

<sup>3)</sup> Without load.

<sup>4)</sup> With light/dark ratio 1:1.

<sup>5)</sup> Signal transit time with resistive load.

<sup>6)</sup> AT > 200 μs.

<sup>7)</sup> Reference voltage DC 50 V.

## Ambient data

<b>Ambient operating temperature</b>	-10 °C ... +55 °C
<b>Ambient storage temperature</b>	-10 °C ... +75 °C
<b>Shock load</b>	According to IEC 60068
<b>UL File No.</b>	NRKH.E181493 & NRKH7.E181493

B

## Ordering information

Other models → [www.sick.com/de/en/KT10](http://www.sick.com/de/en/KT10)

Light spot direction <sup>1)</sup>	Output type	Type	Part no.
Vertical	PNP	KT10W-2P1115	1028232
	NPN	KT10W-2N1115	1028233
Horizontal	PNP	KT10W-2P2115	1029070
	NPN	KT10W-2N2115	1029071

<sup>1)</sup> In relation to long side of housing.

## Dimensional drawing (Dimensions in mm (inch))

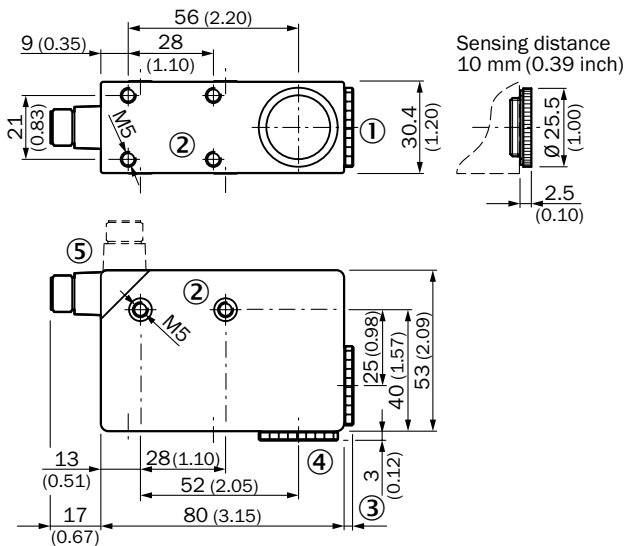

- ① Lens (light transmission)
- ② M5 threaded mounting hole, 5.5 mm deep
- ③ See dimensional drawing of lens
- ④ Blind screw can be replaced by pos. 1
- ⑤ Connector M12 (rotatable up to 90°)

## Adjustments

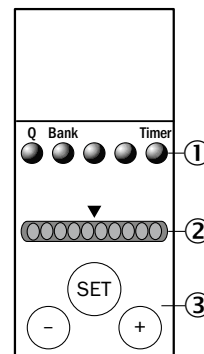

- ① Function signal indicators (yellow)
- ② Bar graph (green)
- ③ Teach-in button/"+" and "-" button



Connection diagram

Cd-313

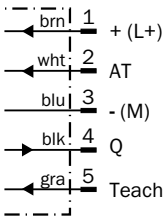

Sensing distance

KT8 CAN, KT10-2

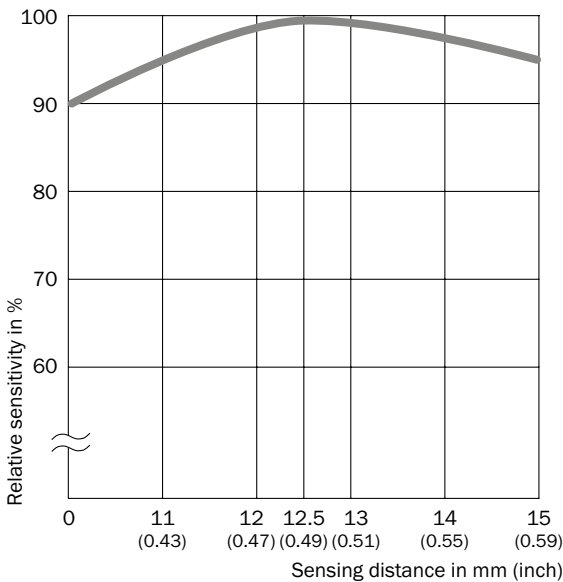

**B**

Setting the switching threshold

Teach-in dynamic

1. Position background

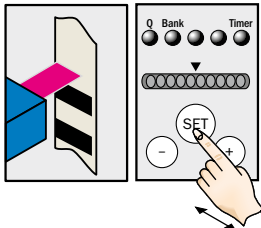

Press and hold SET button. Emitted light turns white.

2. Move at least one repeat length using the light spot

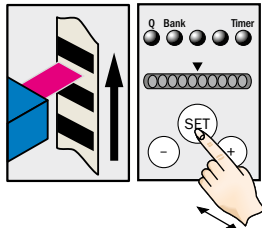

Hold down SET button.

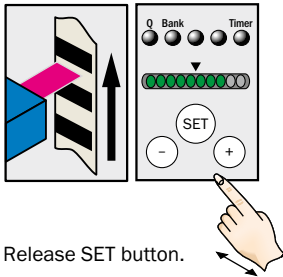

Release SET button.

B

**Teach-in static**

**1. Position mark**

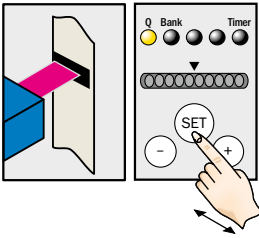

Press and hold SET button > 1 s.  
Red emitted light and yellow LED flash.

**2. Position background**

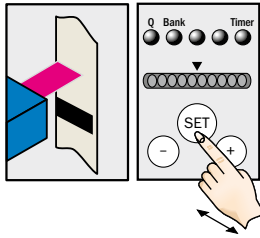

Press and hold SET button > 1 s.  
Yellow LED goes out.  
Optimum emitted light is selected.

**Note**

The bar display visualizes the detection reliability during teach-in. The more LEDs that illuminate, the better the teach-in:  
 1 LED illuminates = operation not reliable – lowest contrast difference  
 ≤ 4 LEDs illuminate = operation OK – sufficient contrast difference  
 > 4 LEDs illuminate = reliable operation – high contrast difference

**Example**

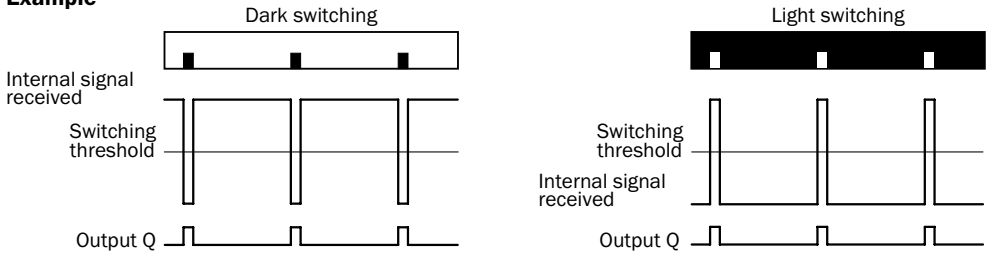







**Switching characteristics**

Light/dark setting is defined using teach-in sequence.  
 The switching threshold is set in the center between the background and the mark.  
 Teach-in and the light/dark setting can also be configured using an external control signal.

Recommended accessories

Universal bar clamp systems



Figure	Material	Description	Type	Part no.
	Steel, zinc coated	Plate G for universal clamp bracket	BEF-KHS-G01	2022464
		Plate K for universal clamp bracket	BEF-KHS-K01	2022718
		Universal clamp bracket for rod mounting	BEF-KHS-KH1	2022726
		Mounting bar, straight, 200 mm, steel	BEF-MS12G-A	4056054
		Mounting bar, straight, 300 mm, steel	BEF-MS12G-B	4056055
		Mounting bar, L-shaped, 150 mm x 150 mm, steel	BEF-MS12L-A	4056052
		Mounting bar, L-shaped, 250 x 250 mm, steel	BEF-MS12L-B	4056053

**B**

Plug connectors and cables

Connecting cables with female connector

M12, 5-pin, PVC, chemical resistant

Figure	Connection type head A	Connection type head B	Connecting cable	Type	Part no.
	Female connector, M12, 5-pin, straight, unshielded	Cable, open conductor heads	2 m, 5-wire	DOL-1205-G02M	6008899
			5 m, 5-wire	DOL-1205-G05M	6009868
	Female connector, M12, 5-pin, angled, unshielded	Cable, open conductor heads	2 m, 5-wire	DOL-1205-W02M	6008900
			5 m, 5-wire	DOL-1205-W05M	6009869

→ For additional accessories, please see page K-240

C



## COLOR SENSORS

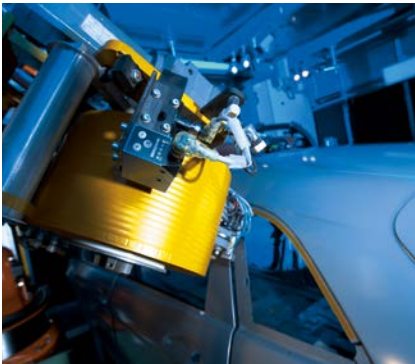

### Focus on color

Color sensors detect the color of a surface. The sensors cast light (red, green, and blue LEDs) on the objects to be tested, calculate the chromaticity coordinates from the reflected radiation and compare them with previously stored reference colors. If the color values are



within the set tolerance range, a switching output is activated.

#### Your benefits

- Identify and store up to eight colors. No need to reprogram the sensor for changeovers, reducing downtime.
- High resolution colors can be matched exactly for better process reliability
- Simple, intuitive operation saves time
- Broad spectrum of color tolerances enables more flexible use



C

<b>General information</b> . . . . .		<b>C-88</b>
<b>Product family overview</b> . . . . .		<b>C-93</b>
	<b>CSM</b> . . . . . Mini, easy, smart	<b>C-94</b>
	<b>CS8</b> . . . . . High-performance color sensing	<b>C-100</b>

## THEY'LL NEVER MAKE YOU BLUE

**C** When confronted with too many colors, some people start to see red. In situations like this, you need something that will keep a cool head and retain control – like SICK color sensors, which will give you the green light for color detection and distinction.

Whenever color is the most important criterion for precise detection, checking, and sorting, SICK color sensors are the right choice. They

offer impressively simple teach-in, high switching frequencies, and numerous application possibilities.



# INTELLIGENT COLOR DETECTION

Thanks to additive color mixing, the color sensors are able to generate white light with red, green, and blue light emitting diodes (●●●, RGB). The sensors send this light to the object to be detected. The sensors calculate the chromaticity coordinates from the beam reflected from the object and compare these with the previously stored reference tristimulus values.

If the color values are within the set tolerance band, a switching output is activated. Intelligent analysis in the sensor provides the basis for reliable operation.



C

## Teach-in



Reference colors can be easily stored via the teach-in procedure. If the color sensor detects the stored value, it automatically activates the switching output.

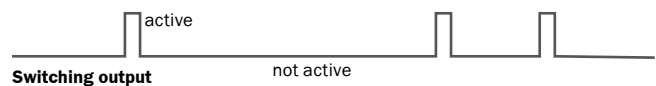
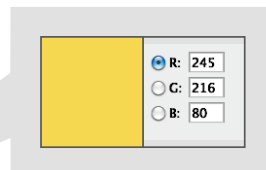



Tolerance

C



Tolerances can be easily configured for color sensors, ranging from coarse to fine depending on the application.

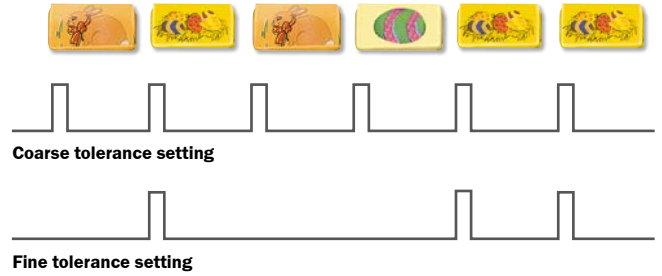

Light spot



The size of the color sensor's light spot depends on the sensing distance.

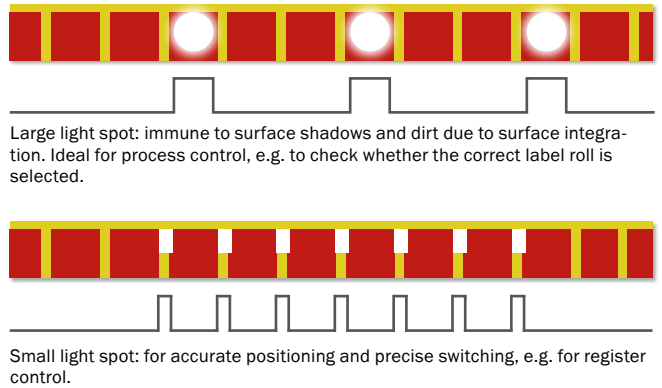

## TYPICAL APPLICATIONS

### Stamp monitoring

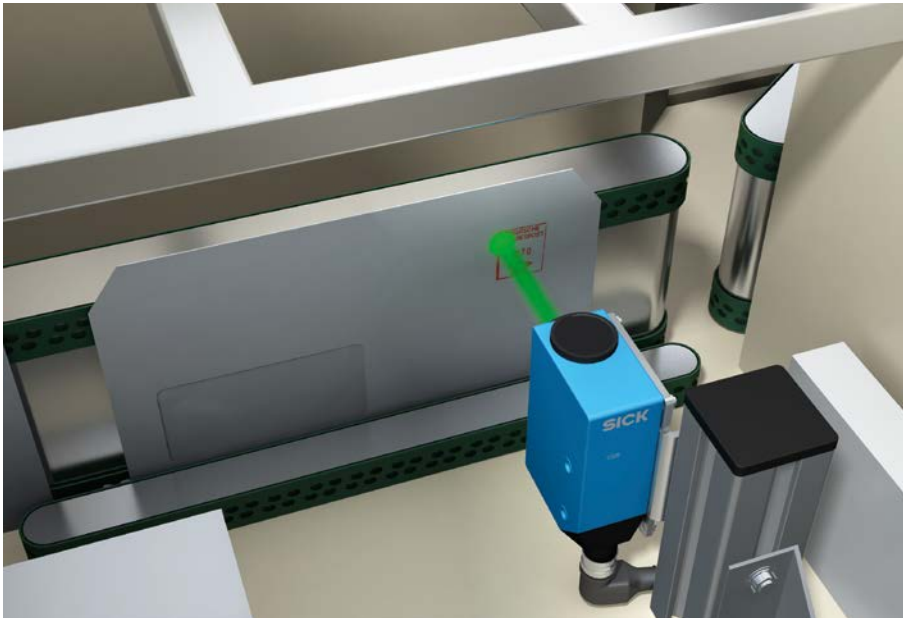

The CS8 color sensor securely and reliably checks that the taught red stamping is present and legible.

C

### PSDI control on a packaging machine

For aesthetic reasons, the manufacturer does not want print marks or the associated reading lines on the back of the packaging. The color sensor controls the packaging process based solely on a color element in the print image. Here, one-off teach-in to the color sensor is sufficient. With the small, precise light spot, the color sensor scans the foil and switches whenever it detects the taught color. Print marks are, therefore, no longer necessary.



### Food industry

In the food industry, CSM color sensors are used to detect print errors on packaging. So that packages with incorrect printing can be rejected reliably, the correct color or color scheme is taught in on the color sensor through a simple teach-in operation and the tolerance is set. This means that erroneous packages will be detected and removed.



C

# PRODUCT FAMILY OVERVIEW



**CSM**  
Mini, easy, smart

**CS8**  
High-performance color sensing

Technical data overview		
Sensing distance	12.5 mm	12.5 mm 60 mm
Light spot size	1.5 mm x 6.5 mm	2 mm x 4 mm 13 mm x 13 mm
Switching frequency	1.7 kHz	1 color up to 6 kHz 4 colors up to 3.5 kHz
Response time	300 µs	1 color up to 85 µs 4 colors up to 145 µs
Output type	PNP / NPN	PNP / NPN
Output (channel)	1 color	1 color 4 colors
Adjustment	1-point-teach-in	Static 1-point teach-in
Connection type	Cable with male connector	Male connector

At a glance		
	<ul style="list-style-type: none"> <li>• Color sensor in a new miniature housing</li> <li>• Static and teach-in method for 1 color using control cable or control panel</li> <li>• Over IO-Link up to 8 colors teachable</li> <li>• Switching frequency: 1.7 kHz</li> <li>• Sensing distance: 12.5 mm</li> <li>• Compatibility with older color sensors thanks to cable with male connector M12</li> </ul>	<ul style="list-style-type: none"> <li>• One (CS8-1) or four (CS8-4) colors can be saved</li> <li>• 12.5 mm or 60 mm sensing distance</li> <li>• Fast response time up to 85 µs</li> <li>• High resolution color</li> <li>• Bar graph display shows the correlation of the colors</li> <li>• Extremely precise light spot and high resolution</li> <li>• Metal housing with two light exits (interchangeable)</li> </ul>

Detailed information	→ C-94	→ C-100
----------------------	--------	---------

# MINI, EASY, SMART

C



## Product description

The new CSM color sensor from SICK offers improved gloss behavior combined with an IO-Link function and a miniature housing. The CSM is ideal for applications where color characteristics need to be detected reliably and installation space is at a premium. The sensor detects and monitors objects on the basis of their color. The small CSM

color sensor can be set using a simple teach-in method, while the new IO-Link function enables intelligent diagnostics, visualization of sensor parameters, and straightforward format changes. Thanks to a switching frequency of up to 1.7 kHz, the CSM is also suitable for use with high-speed machines and manufacturing processes.

## At a glance

- Color sensor in a new miniature housing
- Static and teach-in method for 1 color using control cable or control panel
- Over IO-Link up to 8 colors teachable
- Switching frequency: 1.7 kHz
- Sensing distance: 12.5 mm
- Compatibility with older color sensors thanks to cable with male connector M12

## Your benefits

- Fast, seamless integration into existing applications thanks to a new miniature housing, saving time and money
- Increased switching frequency for improved machine productivity
- Flexible application possibilities thanks to a wide range of color tolerances
- Enhanced, intelligent diagnostics and visualization, as well as quick and easy format changes, thanks to IO-Link function
- Quick and easy installation cuts down on installation time
- Sorting processes are simplified by the distinction of up to 8 colors in one job



## Additional information

Detailed technical data . . . . .C-95  
 Ordering information . . . . .C-96  
 Dimensional drawing . . . . .C-96  
 Connection diagram. . . . .C-96  
 Adjustments . . . . .C-97  
 Sensing distance . . . . .C-97  
 Setting the switching threshold . .C-97  
 Recommended accessories . . . .C-98

→ [www.sick.com/de/en/CSM](http://www.sick.com/de/en/CSM)

For more information, just enter the link or scan the QR code and get direct access to technical data, CAD design models, operating instructions, software, application examples and much more.



## Detailed technical data

### Features

<b>Dimensions (W x H x D)</b>	12 mm x 32 mm x 22 mm
<b>Housing design (light emission)</b>	Rectangular
<b>Light source <sup>1)</sup></b>	LED
<b>Type of light</b>	RGB
<b>Wave length</b>	640 nm, 525 nm, 470 nm
<b>Teach-in mode</b>	1-point-teach-in

<sup>1)</sup> Average service life: 100,000 h at  $T_U = +25\text{ °C}$ .

### Mechanics/electronics

<b>Supply voltage <sup>1)</sup></b>	12 V DC ... 24 V DC
<b>Ripple <sup>2)</sup></b>	$< 5 V_{pp}$
<b>Power consumption <sup>3)</sup></b>	$< 50\text{ mA}$
<b>Switching frequency <sup>4)</sup></b>	1.7 kHz
<b>Response time <sup>5)</sup></b>	300 $\mu\text{s}$
<b>Jitter</b>	150 $\mu\text{s}$
<b>Switching output</b>	PNP: HIGH = $V_S - \leq 2\text{ V}$ / LOW approx. 0 V NPN: HIGH = approx. $V_S$ / LOW $\leq 2\text{ V}$ (depending on type)
<b>Output (channel)</b>	1 color / 8 colors via IO-Link
<b>Output current <math>I_{max}</math> <sup>6)</sup></b>	$< 100\text{ mA}$
<b>Input, teach-in (ET)</b>	PNP Teach: $U = 10\text{ V} \dots < U_V$ Run: $U < 2\text{ V}$ or open NPN Teach: $U < 2\text{ V}$ Run: $U = 10\text{ V} \dots < U_V$ or open (depending on type)
<b>Connection type</b>	Cable with connector M12, 4-pin, 0.2 m
<b>Protection class</b>	III
<b>Circuit protection</b>	$V_S$ connections reverse-polarity protected, Output Q short-circuit protected, Interference suppression
<b>Enclosure rating</b>	IP 67
<b>Weight</b>	25 g
<b>Housing material</b>	Plastic, ABS

<sup>1)</sup> Limit values: DC 12 V (-10 %) ... DC 24 V (+20 %). Operation in short-circuit protected network max. 8 A.

<sup>2)</sup> May not exceed or fall below  $U_V$  tolerances.

<sup>3)</sup> Without load.

<sup>4)</sup> With light/dark ratio 1:1.

<sup>5)</sup> Signal transit time with resistive load.

<sup>6)</sup> At supply voltage  $> 24\text{ V}$ ,  $I_{max} = 30\text{ mA}$ .  $I_{max}$  is consumption count of all  $Q_n$ .

### Ambient data

<b>Ambient operating temperature</b>	-10 °C ... +55 °C
<b>Ambient storage temperature</b>	-20 °C ... +75 °C
<b>Shock load</b>	According to IEC 60068
<b>UL File No.</b>	NRKH.E181493 & NRKH7.E181493

Ordering information

Other models → [www.sick.com/de/en/CSM](http://www.sick.com/de/en/CSM)

- Sensing distance tolerance: ± 3 mm
- Light spot direction: vertical

Sensing distance <sup>1)</sup>	Light spot size	Fieldbus interface	Output type	Connection diagram	Type	Part no.
12.5 mm	1.5 mm x 6.5 mm	-	PNP	Cd-092	CSM-WP11122P	1067291
			NPN	Cd-092	CSM-WN11122P	1067293
		IO-Link	PNP	Cd-321	CSM-WP117A2P	1067294

<sup>1)</sup> From front edge of lens.

C

Dimensional drawing (Dimensions in mm (inch))

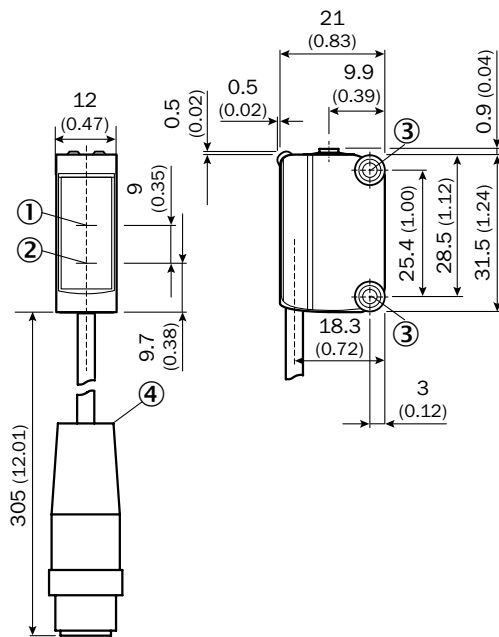

- ① Optical axis receiver
- ② Optical axis sender
- ③ Fixing hole M3
- ④ Cable with male connector

Connection diagram

Cd-092

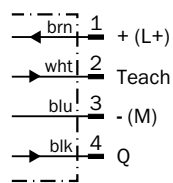

Cd-321

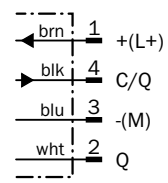



Adjustments

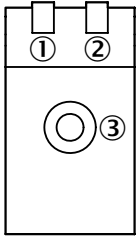

- ① Status indicator LED, yellow: Status switching output Q
- ② Status indicator LED green: supply voltage on
- ③ Teach-in button

Sensing distance

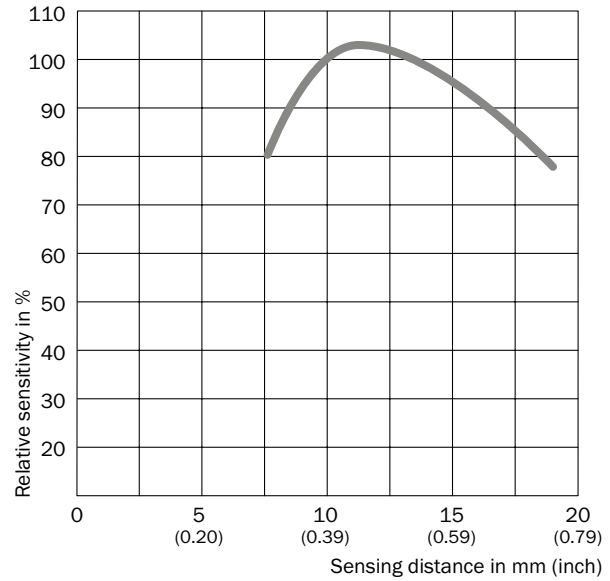

Setting the switching threshold

1. Trigger teach-in

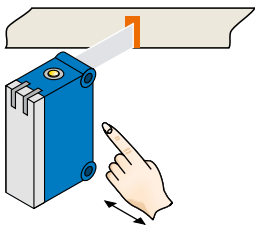

Position object in light field.  
Press teach-in button > 1 s.

2. Select color tolerance

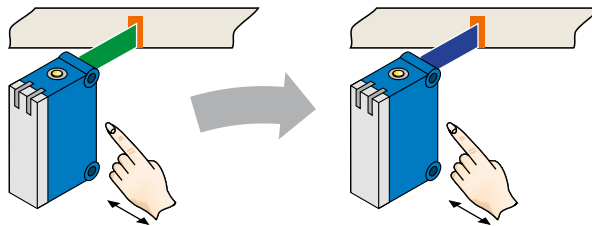

Press teach-in button when transmitted light is green  
= **tolerance medium**  
(standard setting).

Press teach-in button when transmitted light is blue  
= **tolerance precise.**

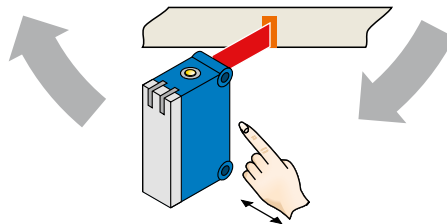

Press teach-in button when transmitted light is red  
= **tolerance coarse.**

Teach-in can also be performed using an external control signal (only dynamic teach-in).



Keylock activation and deactivation: hold down teach-in button > 30 s.

Teach-in failure: yellow LED indicator and the transmitted light of the sensor flashing quickly.

Recommended accessories



Universal bar clamp systems

C

Figure	Material	Description	Type	Part no.
	Steel, zinc coated	Universal clamp bracket for rod mounting	BEF-KHS-KH1	2022726
		Plate L for universal clamp bracket	BEF-KHS-L01	2023057
	Zinc plated steel (sheet), diecast zinc (clamp)	Plate N08 for universal clamp bracket	BEF-KHS-N08	2051607
	Stainless steel 1.4571 (sheet), stainless steel 1.4408 (clamp)	Plate N08N for universal clamp bracket	BEF-KHS-N08N	2051616
	Steel, zinc coated	Mounting bar, straight, 200 mm, steel	BEF-MS12G-A	4056054
		Mounting bar, straight, 300 mm, steel	BEF-MS12G-B	4056055
Mounting bar, L-shaped, 150 mm x 150 mm, steel		BEF-MS12L-A	4056052	
Mounting bar, L-shaped, 250 x 250 mm, steel		BEF-MS12L-B	4056053	

Mounting brackets and mounting plates

Mounting brackets



Figure	Material	Description	Type	Part no.
	Stainless steel	Mounting bracket for wall mounting	BEF-W100-A	5311520
	Steel, zinc coated	Mounting bracket for floor mounting	BEF-W100-B	5311521
			BEF-WN-W100-S01	4073866

Mounting plates

Figure	Material	Description	Type	Part no.
	Stainless steel	Adapter plate CSM1 to CSM	BEF-AP-KTMS01	2068786

Modules and gateways



Connection modules

Figure	Description	Type	Part no.
	IO-Link version V1.1, Port class 2, PIN 2, 4, 5 galvanically connected, Supply voltage 18 V DC ... 32 V DC (limit values, operation in short-circuit protected network max. 8 A)	SICK Memory Stick	1064290
	IO-Link V1.1 Class A port, USB2.0 port, optional external power supply 24V / 1A	SiLink2 Master	1061790

## Plug connectors and cables

Connecting cables with female connector

M12, 4-pin, PVC, chemical resistant

Figure	Connection type head A	Connection type head B	Connecting cable	Type	Part no.
	Female connector, M12, 4-pin, straight, unshielded	Cable, open conductor heads	2 m, 4-wire	DOL-1204-G02M	6009382
			5 m, 4-wire	DOL-1204-G05M	6009866
	Female connector, M12, 4-pin, angled, unshielded	Cable, open conductor heads	2 m, 4-wire	DOL-1204-W02M	6009383
			5 m, 4-wire	DOL-1204-W05M	6009867

→ For additional accessories, please see page K-240

**C**

# HIGH-PERFORMANCE COLOR SENSING

C

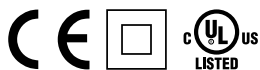

### Additional information

Detailed technical data . . . . .C-101  
 Ordering information . . . . .C-102  
 Dimensional drawing . . . . .C-102  
 Connection diagram . . . . .C-102  
 Adjustments . . . . .C-103  
 Display color correspondence . .C-104  
 Setting the switching threshold .C-103  
 Recommended accessories . . .C-104

### Product description

The ability to teach up to four colors can lead to faster changeovers and shorter downtime. The CS8 series offers high switching speeds – as fast as 6 kHz (85 µsec) – enabling higher throughput. And, the sensor maintains the extreme precision of the lightspot; this sharp,

well-defined spot provides tighter process control and more consistent object detection. A bar graph display enables easy setup and provides information about the color quality and detection reliability.

### At a glance

- One (CS8-1) or four (CS8-4) colors can be saved
- 12.5 mm or 60 mm sensing distance
- Fast response time up to 85 µs
- High resolution color
- Bar graph display shows the correlation of the colors
- Extremely precise light spot and high resolution
- Metal housing with two light exits (interchangeable)

### Your benefits

- Identify and store up to four colors. No need to reprogram the sensor for changeovers, reducing downtime.
- High resolution colors can be matched exactly for better process reliability
- Maintains the extreme precision of the light spot, enabling a consistent object detection
- A bar graph display provides information about the color quality and detection reliability, ensuring simple process monitoring
- Broad spectrum of color tolerances enables more flexible use
- Fast response times at high speeds for reliable detection
- Detection reliability is not affected by varying temperatures

→ [www.sick.com/de/en/CS8](http://www.sick.com/de/en/CS8)

For more information, just enter the link or scan the QR code and get direct access to technical data, CAD design models, operating instructions, software, application examples and much more.



## Detailed technical data

### Features

<b>Dimensions (W x H x D)</b>	30.4 mm x 80 mm x 53 mm
<b>Housing design (light emission)</b>	Rectangular
<b>Light source <sup>1)</sup></b>	LED
<b>Type of light</b>	RGB
<b>Wave length</b>	640 nm, 525 nm, 470 nm
<b>Teach-in mode</b>	Static 1-point teach-in

<sup>1)</sup> Average service life: 100,000 h at  $T_U = +25\text{ °C}$ .

### Mechanics/electronics

<b>Supply voltage <sup>1)</sup></b>	10 V DC ... 30 V DC
<b>Ripple <sup>2)</sup></b>	$< 5 V_{pp}$
<b>Power consumption <sup>3)</sup></b>	$< 120\text{ mA}$
<b>Switching output</b>	PNP: HIGH = $V_S - \leq 2\text{ V}$ / LOW approx. 0 V / NPN: HIGH = approx. $V_S$ / LOW $\leq 2\text{ V}$ (depending on type)
<b>Output current <math>I_{max.}</math> <sup>4)</sup></b>	$< 100\text{ mA}$
<b>Input, teach-in (ET)</b>	PNP Teach: $U = 10\text{ V} \dots < U_V$ Run: $U < 2\text{ V}$ NPN Teach: $U < 2\text{ V}$ Run: $U = 10\text{ V} \dots < U_V$
<b>Input, blanking input (AT)</b>	PNP Blanked: $U > 10\text{ V} \dots < U_V$ Free-running: $U < 2\text{ V}$ <sup>5)</sup> NPN Blanked: $U < 2\text{ V}$ Free-running: $U > 10\text{ V} \dots < U_V$ <sup>5)</sup>
<b>Retention time (ET)</b>	25 ms, non-volatile memory
<b>Time delay</b>	Deactivation delay 20 ms, shiftable
<b>Connection type</b>	Connector M12, 5-pin, male connector M12, 8-pin (depending on type)
<b>Protection class <sup>6)</sup></b>	II
<b>Circuit protection</b>	$V_S$ connections reverse-polarity protected, Output Q short-circuit protected, Interference suppression
<b>Fieldbus interface</b>	-
<b>Enclosure rating</b>	IP 67
<b>Weight</b>	400 g
<b>Housing material</b>	Metal, zinc diecast

<sup>1)</sup> Limit values; operation in short-circuit protected network max. 8 A.

<sup>2)</sup> May not exceed or fall below  $U_V$  tolerances.

<sup>3)</sup> Without load.

<sup>4)</sup> Consumption count Q1 / Q2.

<sup>5)</sup> AT > 200  $\mu\text{s}$ .

<sup>6)</sup> Reference voltage DC 32 V.

### Ambient data

<b>Ambient operating temperature</b>	$-10\text{ °C} \dots +55\text{ °C}$
<b>Ambient storage temperature</b>	$-20\text{ °C} \dots +75\text{ °C}$
<b>Shock load</b>	According to IEC 60068
<b>UL File No.</b>	NRKH.E181493 & NRKH7.E181493

Ordering information

Other models → [www.sick.com/de/en/CS8](http://www.sick.com/de/en/CS8)

CS8-1, 1 color

- **Switching frequency:** 1 kHz, 3 kHz, 6 kHz (adjustable, with light/dark ratio 1:1.)
- **Response time:** 500 µs, 160 µs, 85 µs (Signal transit time with resistive load.)
- **Connection type:** connector M12, 5-pin

Sensing distance <sup>1)</sup>	Sensing distance tolerance	Light spot size	Light spot direction	Output type	Connection diagram	Type	Part no.
12.5 mm	± 3 mm	2 mm x 4 mm	Vertical	PNP	Cd-313	CS81-P1112	1028224
				NPN	Cd-313	CS81-N1112	1028228
60 mm	± 9 mm	13 mm x 13 mm	-	PNP	Cd-313	CS81-P3612	1028225
				NPN	Cd-313	CS81-N3612	1028229

<sup>1)</sup> From front edge of lens.

C

CS8-4, 4 colors

- **Switching frequency:** 0.5 kHz, 1 kHz, 3.5 kHz (adjustable, with light/dark ratio 1:1.)
- **Response time:** 1,000 µs, 500 µs, 145 µs (Signal transit time with resistive load.)
- **Connection type:** male connector M12, 8-pin

Sensing distance <sup>1)</sup>	Sensing distance tolerance	Light spot size	Light spot direction	Output type	Connection diagram	Type	Part no.
12.5 mm	± 3 mm	2 mm x 4 mm	Vertical	PNP	Cd-311	CS84-P1112	1028226
				NPN	Cd-311	CS84-N1112	1028230
60 mm	± 9 mm	13 mm x 13 mm	-	PNP	Cd-311	CS84-P3612	1028227
				NPN	Cd-311	CS84-N3612	1028231

<sup>1)</sup> From front edge of lens.

Dimensional drawing (Dimensions in mm (inch))

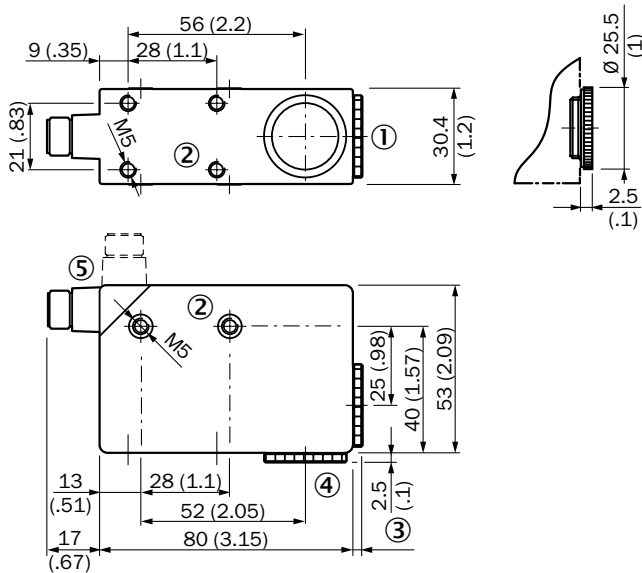

- ① Lens (light transmission)
- ② M5 threaded mounting hole, 5.5 mm deep
- ③ See dimensional drawing for lens
- ④ Blind screw can be replaced by lens
- ⑤ Connector M12 (rotatable up to 90°)

Connection diagram

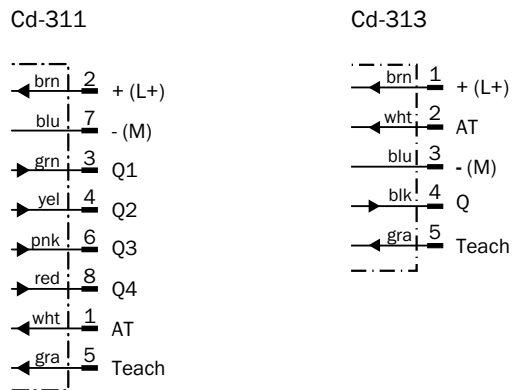

Adjustments

CS8-1

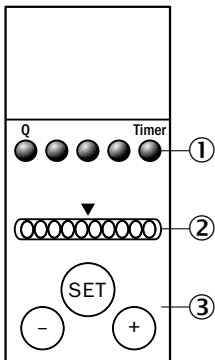

- ① Function signal indicators (yellow)
- ② Bar graph (green), Power on left LED
- ③ Teach-in button/"+" and "-" button

CS8-4

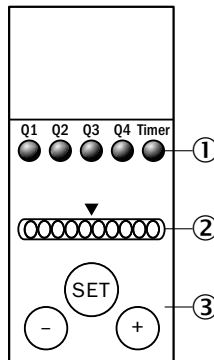

- ① Function signal indicators (yellow)
- ② Bar graph (green), Power on left LED
- ③ Teach-in button/"+" and "-" button

C

Setting the switching threshold

CS8-1

1. Trigger teach-in

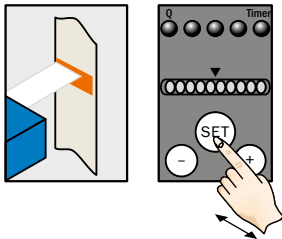

Position object in light field.  
Press SET button > 1 s.

2. Select color tolerance

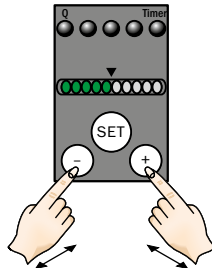

If necessary adapt tolerance with  
"+" button (more coarse) or  
"-" button (more precise).

3. Confirm teach-in

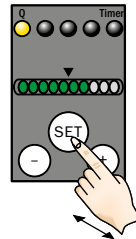

Press SET button > 1 s.  
Color correspondence is  
visualized via bar graph display.

CS8-4

1. Trigger teach-in

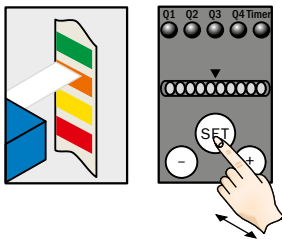

Position object in light field.  
Press SET button > 1 s.

2. Select color tolerance

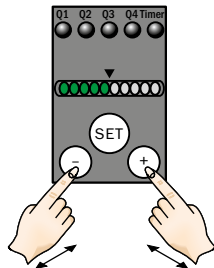

If requested adapt tolerance with  
"+" button (more coarse) or  
"-" button (more precise).  
Press SET button > 1 s.

3. Allocate channel to color

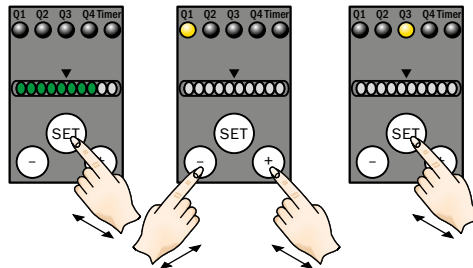

Allocate channel for color with  
"+" button (Q1 to Q4) or  
"-" button (Q4 to Q1).  
Press SET button > 1 s.

4. Confirm teach-in

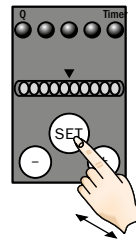

Press SET button > 1 s.  
Color correspondence is  
visualized via bar graph  
display.

## Display of the color correspondence

### 1. Full correspondence

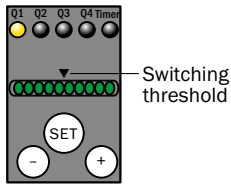

Color detected  
= Q active.

### 2. Correspondence

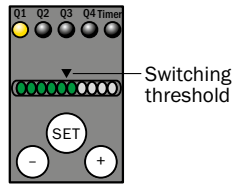

Color just detected  
= Q active.

### 3. No correspondence

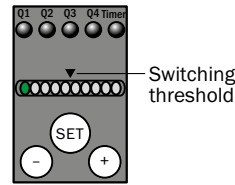

Color not detected  
= Q inactive.

### Special settings

“Evaluation mode,” “Tolerance change during operation,” “Show quality,” “Time stage,” and “Output logic” can be set via a special menu (cf. appropriate operating instructions for the device).



> 1 s = enter/exit

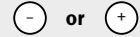

< 1 s = navigate



> 1 s = select/confirm

## Recommended accessories

### Universal bar clamp systems

Figure	Material	Description	Type	Part no.
	Steel, zinc coated	Plate G for universal clamp bracket	BEF-KHS-G01	2022464
		Plate K for universal clamp bracket	BEF-KHS-K01	2022718
		Universal clamp bracket for rod mounting	BEF-KHS-KH1	2022726
		Mounting bar, straight, 200 mm, steel	BEF-MS12G-A	4056054
		Mounting bar, straight, 300 mm, steel	BEF-MS12G-B	4056055
		Mounting bar, L-shaped, 150 mm x 150 mm, steel	BEF-MS12L-A	4056052
		Mounting bar, L-shaped, 250 x 250 mm, steel	BEF-MS12L-B	4056053

### Plug connectors and cables

#### Connecting cables with female connector

##### M12, 5-pin, PVC, chemical resistant

Figure	Connection type head A	Connection type head B	Connecting cable	Type	Part no.
	Female connector, M12, 5-pin, straight, unshielded	Cable, open conductor heads	2 m, 5-wire	DOL-1205-G02M	6008899
			5 m, 5-wire	DOL-1205-G05M	6009868
			10 m, 5-wire	DOL-1205-G10M	6010544
	Female connector, M12, 5-pin, angled, unshielded	Cable, open conductor heads	2 m, 5-wire	DOL-1205-W02M	6008900
			5 m, 5-wire	DOL-1205-W05M	6009869
			10 m, 5-wire	DOL-1205-W10M	6010542

##### M12, 8-pin, PVC

Figure	Connection type head A	Connection type head B	Connecting cable	Type	Part no.
	Female connector, M12, 8-pin, straight, shielded	Cable, open conductor heads	2 m, 8-wire	DOL-1208-G02MA	6020633
			5 m, 8-wire	DOL-1208-G05MA	6020993



Figure	Connection type head A	Connection type head B	Connecting cable	Type	Part no.
	Female connector, M12, 8-pin, angled, shielded	Cable, open conductor heads	2 m, 8-wire	DOL-1208-W02MA	6020992
			5 m, 8-wire	DOL-1208-W05MA	6021033

→ For additional accessories, please see page K-240

**C**

D



## LUMINESCENCE SENSORS



### The bright idea for fluorescent material

Luminescence sensors detect visible and non-visible marks that illuminate when using ultraviolet (UV) light. Fluorescent material and marks are reliably detected independently of their pattern, colors or surface conditions on any material. Luminescence sensors emit UV light with a wave length of approximately 375 nm. Fluorescent substances

convert the UV light into long-wave visible light, which is then received and evaluated by the luminescence sensor.





#### Your benefits

- 90 % of the applications can be solved using the default factory setting. A simple setup permits the adjustment to specific tasks.

- Set up in minutes, saving time and money
- The right solution for everybody – there is a wide range of models, depending on applications
- Filters ensure that background luminescence is reliably suppressed, enabling greater process reliability



D

<b>General information</b> . . . . .		<b>.D-108</b>
<b>Product family overview</b> . . . . .		<b>.D-112</b>
	<b>LUTM</b> . . . . . Small, intelligent luminescence sensor	<b>.D-114</b>
	<b>LUT3-6</b> . . . . . The solution for standard applications	<b>.D-120</b>
	<b>LUT8</b> . . . . . For universal use with easy adjustment	<b>.D-126</b>
	<b>LUT9</b> . . . . . The new standard for high-performance luminescence sensors	<b>.D-132</b>

## CAN YOU SEE WHAT IT SEES?

Sometimes there is no point in taking a second look: Some things simply cannot be detected. And that is why even a detective needs the right tool to hunt down clues. SICK luminescence sensors deploy a UV light to uncover things that would otherwise remain concealed.

Luminescence sensors detect marks that light up exclusively under UV light. This is due to fluorescent substances contained in the mark,

which convert UV light into visible light. The luminescence sensor receives the light reflected by the object and analyzes it.



D

## LUMINOPHORES PROVIDE THE CRUCIAL CLUE

The illumination effect of the fluorescent substances is attributable to admixed luminophores – small particles that convert UV light into visible light in different wavelength ranges and at different intensities. Luminophores can be admixed with almost all substances. Typical examples are chalk or wax crayon, ink, oil, grease, labels, and felt-tip pens.

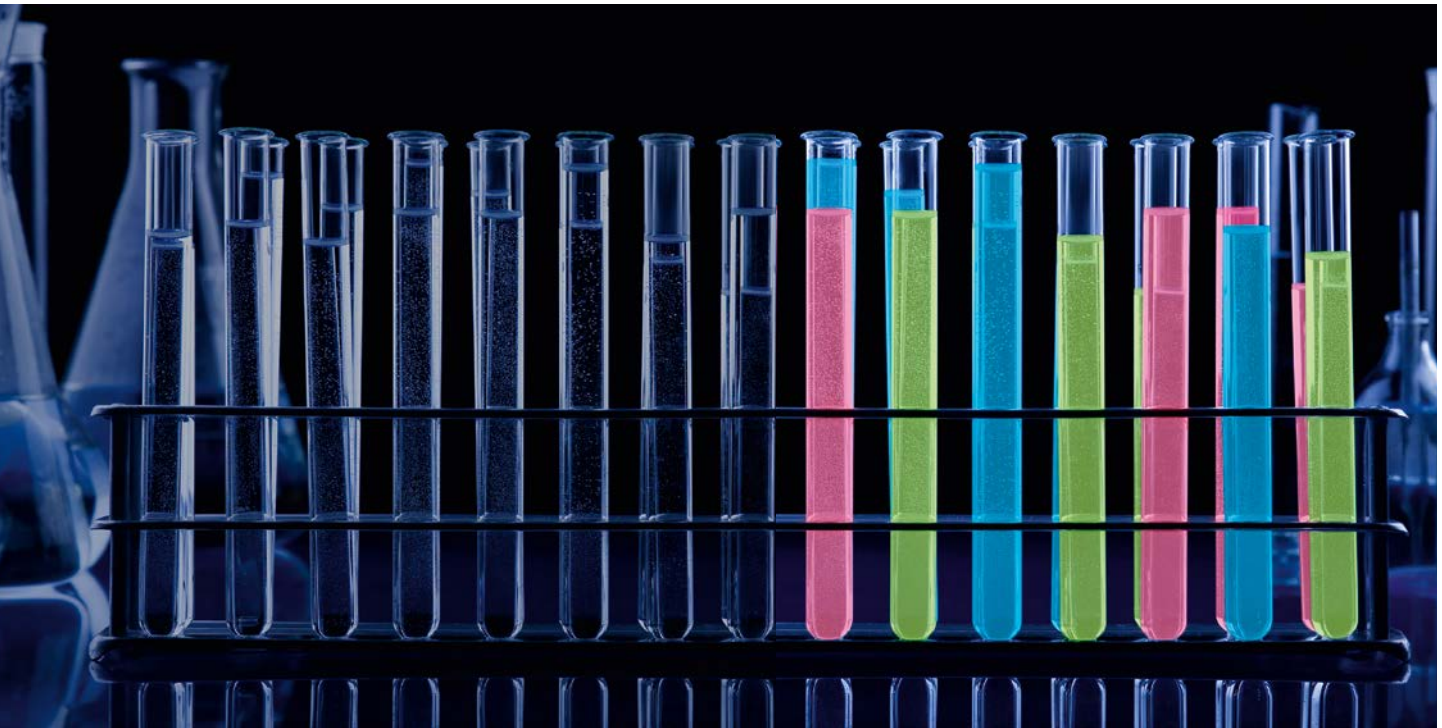

D

### Operating principle

Luminescence sensors emit modulated UV light with a wavelength of 375 nm. This stimulates fluorescent substances, which send back light with a long wavelength in the visible spectrum (approx. 420 to 750 nm). Luminescence sensors detect this light and analyze it.

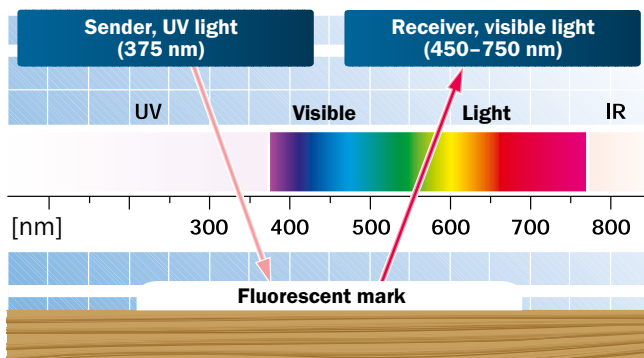

### Function of the filters

The example shows the use of the RG610 filter. Wavelength ranges below 610 nm (purple, blue, green) are suppressed and only visible light with a wavelength of more than 610 nm (red) reaches the receiver. This means that disruptive background luminescences that light up green or blue can be reliably suppressed, e.g. a red mark on white paper.

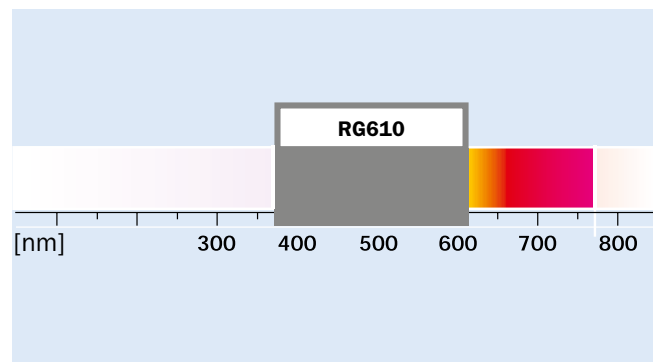



## Luminescence scale

The luminescence scale (available from SICK) is used as the reference for the switching properties of the luminescence sensors. The luminescence scale can be used to check readability under different signal intensities to achieve reliable use in different areas of application. The check is a relative mea-

surement between the scale and the test material with the aid of the analog output. With the LUT8 and LUT9 sensors, the bar graph shows the luminescence intensity – left 30 %, right 200 % in relation to the reference, depending on the sensing distance.



30 % signal strength in relation to the reference



200 % signal strength in relation to the reference

## TYPICAL APPLICATIONS

### Woodworking industry: Calculating capping

Knotholes and other “flaws” in wooden boards are marked for subsequent removal by sawing. The luminescence sensor picks up fluorescent chalk or ink on a very wide range of wood. Due to their large sensing distances, the sensors can also be mounted at greater distances from the objects to be detected. This means that marks can be reliably detected on different thicknesses of wood – without any mechanical adjustment to the sensors. Their robust metal housing allows the sensors to be used in harsh industrial conditions too.



### Woodworking industry: Monitoring adhesive application

Once the dispenser has applied the adhesive layer, the LUT9 luminescence sensor checks for the adhesive based on the presence of luminophores in the adhesive.



## Food and beverage industry



Manufacturers of luxury goods do not want control marks to impair the visual impact of high-quality label designs. Labels and sealing flaps on these items are aligned with invisible luminescent marks which light up exclusively under UV light and can be detected by the luminescence sensors with ease.



D

## Pharmaceutical industry

Whether inserting package slips into packages or attaching labels to ampules, luminescence sensors maximize process reliability. For this to be possible, a high switching frequency and detection reliability are required – precisely the qualities offered by the luminescence sensors.



## Automotive industry: Front screen quality control

Before a windshield is used, the IVC-2D 2D vision sensor checks whether this is a front screen with a heating wire. The luminescence sensor detects whether a protective coating against UV light is present. The UV light-sensitive sensor is configured such that the path of the sensor beam goes through the front screen onto a mark on the robot. If the front screen is not coated, the beam can detect the mark through the glass unhindered. If the glass has a UV coating, on the other hand, the sensor beam is interrupted.

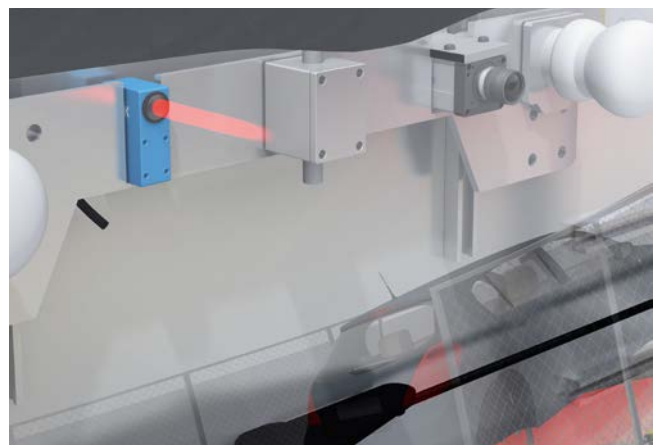

# PRODUCT FAMILY OVERVIEW



**LUTM**

Small, intelligent luminescence sensor



**LUT3-6**

The solution for standard applications

## Technical data overview

<b>Sensing distance</b>	12.5 mm	10 mm 20 mm 50 mm
<b>Type of light</b>	UV	UV
<b>Light emission</b>	Long side	Long side
<b>Switching frequency</b>	6 kHz	1.5 kHz
<b>Response time</b>	80 µs	350 µs
<b>Analog output Q<sub>A</sub></b>	-	-
<b>Adjustment</b>	2-point teach-in static/dynamic	Manual (potentiometer)
<b>Connection type</b>	Cable with connector M12, 4-pin	Connector M12, 4-pin

## At a glance

- |  |  |
|--|--|
| <ul style="list-style-type: none"> <li>• Luminescence sensor in a miniature housing</li> <li>• Static and dynamic teach-in methods in a single variant</li> <li>• Reliable detection even at a low level luminescence</li> <li>• Switching frequency of 6 kHz</li> <li>• Operating range 8 ... 20 mm</li> <li>• Remote monitoring and rapid analysis using IO-Link function</li> <li>• Compatibility with older LUT sensors thanks to cable with male connector M12</li> </ul> | <ul style="list-style-type: none"> <li>• Tough metal housing</li> <li>• Operating range: 0 mm ... 15 mm / 10 mm ... 35 mm / 30 mm ... 60 mm</li> <li>• Sensing distances selectable through interchangeable lenses</li> <li>• Transmitter LED UV (375 nm)</li> </ul> |
|--|--|

Detailed information

→ D-114

→ D-120

D





**LUT8**

For universal use with easy adjustment



**LUT9**

The new standard for high-performance luminescence sensors

	10 mm 20 mm 50 mm 90 mm		10 mm 20 mm 50 mm 90 mm 150 mm
	UV		UV / visible blue light
	Long side		Long side / Long and short side, exchangeable
	2.5 kHz		0.5 kHz 2.5 kHz 6.5 kHz
	200 µs		1 ms / 200 µs / 75 µs
	0 mA ... 13 mA		0 mA ... 13 mA
	Manual (rotary switch)		Static 2-point teach-in with manual fine adjustment / IO-Link (optional)
	Connector M12, 5-pin		Connector M12, 5-pin Connector M12, 4-pin

- Tough metal housing
- Simple sensitivity adjustment in 8 stages
- Bar graph display provides information about the luminescence intensity
- Sensing distances selectable through interchangeable lenses
- Additional optical filters suppress background luminescence
- Fiber-optic cable connection (with 20 mm lens)
- Switching and analog output
- Operating range: 0 mm ... 20 mm / 10 mm ... 40 mm / 20 mm ... 70 mm / 30 mm ... 110 m

→ D-126

- Simple teach-in
- Operating range up to 250 mm
- Version with IO-Link for remote monitoring
- Bar graph display provides information about the luminescence intensity
- High speed (6.5 kHz), standard (2.5 kHz), high resolution (500 Hz) models
- Additional optical filters suppress background luminescence
- Fiber-optic cable connection (with 20 mm lens)
- Switching and analog output

→ D-132

## SMALL, INTELLIGENT LUMINESCENCE SENSOR

D



### Product description

Enhanced performance for fluorescent materials: The new LUTM luminescence sensor from SICK features a novel miniature housing combined with an IO-Link function. The LUTM is ideal for all applications where fluorescent marks need to be reliably detected in confined spaces. Even when the level of luminescence is low, the LUTM detects the relevant marks using its enhanced system

sensitivity. This mini luminescence sensor can be set using a straightforward teach-in method. The innovative IO-Link function enables enhanced, intelligent diagnostics and visualization of sensor parameters, as well as provide quick and easy format changes. Thanks to an increased switching frequency of up to 6 kHz, the LUTM is also suitable for high machine production capacities.

### At a glance

- Luminescence sensor in a miniature housing
- Static and dynamic teach-in methods in a single variant
- Reliable detection even at a low level luminescence
- Switching frequency of 6 kHz
- Operating range 8 ... 20 mm
- Remote monitoring and rapid analysis using IO-Link function
- Compatibility with older LUT sensors thanks to cable with male connector M12

### Your benefits

- Miniature housing enables installation in small spaces
- Quick and easy commissioning saves time and money
- Increased switching frequency for improved machine productivity
- Enhanced, intelligent diagnostics and visualization of sensor parameters, as well as quick and easy format changes, thanks to IO-Link function

 **IO-Link**



### Additional information

Detailed technical data . . . . .	D-115
Ordering information . . . . .	D-116
Dimensional drawing . . . . .	D-116
Adjustments . . . . .	D-116
Connection diagram . . . . .	D-117
Sensing distance . . . . .	D-117
Setting the switching threshold	D-118
Recommended accessories . . .	D-119

→ [www.sick.com/de/en/LUTM](http://www.sick.com/de/en/LUTM)

For more information, just enter the link or scan the QR code and get direct access to technical data, CAD design models, operating instructions, software, application examples and much more.



## Detailed technical data

## Features

Dimensions (W x H x D)	31.5 mm x 21 mm x 12 mm
Sensing distance <sup>1)</sup>	12.5 mm
Housing design (light emission)	Rectangular
Operating range	8 mm, 20 mm
Light source <sup>2)</sup>	LED
Type of light	Ultraviolet light
Wave length	370 nm
Light emission	Long side
Light spot size <sup>3)</sup>	2 mm x 2.5 mm
Light spot direction	Vertical
Receiving range	450 nm ... 750 nm
Adjustment	2-point teach-in static/dynamic
Output function <sup>4)</sup>	Light/dark switching

<sup>1)</sup> From front edge of lens.

<sup>2)</sup> Average service life: 100,000 h at  $T_U = +25\text{ °C}$ .

<sup>3)</sup> At sensing distance.

<sup>4)</sup> L/D switching via teach-in.

## Mechanics/electronics

Supply voltage <sup>1)</sup>	12 V DC ... 24 V DC
Ripple <sup>2)</sup>	$\leq 5\text{ V}_{pp}$
Power consumption <sup>3)</sup>	$\leq 50\text{ mA}$
Switching frequency <sup>4)</sup>	6 kHz
Response time <sup>5)</sup>	80 $\mu\text{s}$
Jitter	40 $\mu\text{s}$
Switching output	PNP: HIGH = $V_S - \leq 2\text{ V}$ / LOW approx. 0 V / NPN: HIGH = approx. $V_S$ / LOW $\leq 2\text{ V}$ ,
Output type	PNP / NPN
Output current $I_{max.}$ <sup>6)</sup>	$< 100\text{ mA}$
Input, teach-in (ET)	PNP Teach: $U = 10\text{ V} \dots < U_V$ Run: $U < 2\text{ V}$ NPN Teach: $U < 2\text{ V}$ Run: $U = 10\text{ V} \dots < U_V$ (depending on type)
Connection type	Cable with connector M12, 4-pin
Protection class	III
Circuit protection	$V_S$ connections reverse-polarity protected, Output Q short-circuit protected, Interference suppression
Fieldbus interface	- / IO-Link (depending on type)
Enclosure rating	IP 67
Weight	25 g
Housing material	Plastic, ABS

<sup>1)</sup> Limit values: DC 12 V (-10 %) ... DC 24 V (+20 %). Operation in short-circuit protected network max. 8 A.

<sup>2)</sup> May not exceed or fall below  $U_V$  tolerances.

<sup>3)</sup> Without load.

<sup>4)</sup> With light/dark ratio 1:1.

<sup>5)</sup> Signal transit time with resistive load.

<sup>6)</sup> At supply voltage  $> 24\text{ V}$ ,  $I_{max.} = 30\text{ mA}$ .  $I_{max.}$  is consumption count of all  $Q_n$ .

Ambient data

Ambient operating temperature	-10 °C ... +55 °C
Ambient storage temperature	-20 °C ... +75 °C
Shock load	According to IEC 60068
UL File No.	NRKH.E181493 & NRKH7.E181493

Ordering information

Other models → [www.sick.com/de/en/LUTM](http://www.sick.com/de/en/LUTM)

- **Light spot size:** 2 mm x 2.5 mm (At sensing distance.)
- **Receiving range:** 450 nm ... 750 nm
- **Connection type:** Cable with connector M12, 4-pin

Sensing distance <sup>1)</sup>	Operating range	Output type	Fieldbus interface	Connection diagram	Type	Part no.
12.5 mm	8 mm ... 20 mm	PNP	-	Cd-023	LUTM-UP81162P	1067295
			IO-Link	Cd-321	LUTM-UP817A2P	1067297
		NPN	-	Cd-023	LUTM-UN81162P	1067296

<sup>1)</sup> From front edge of lens.

D

Dimensional drawing (Dimensions in mm (inch))

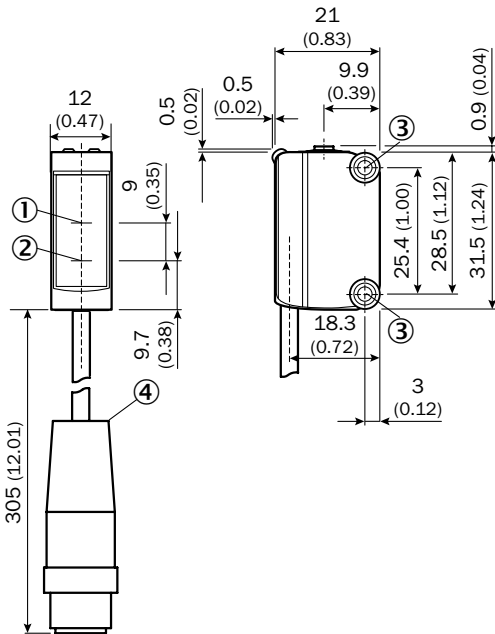

- ① Optical axis receiver
- ② Optical axis sender
- ③ Fixing hole M3
- ④ Cable with male connector

Adjustments

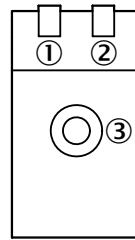

- ① Status indicator LED, yellow: Status switching output Q
- ② Status indicator LED green: supply voltage on
- ③ Teach-in button

### Connection diagram

Cd-023

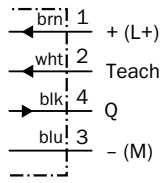

Cd-321

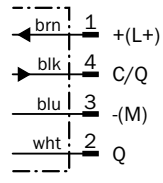

### Sensing distance

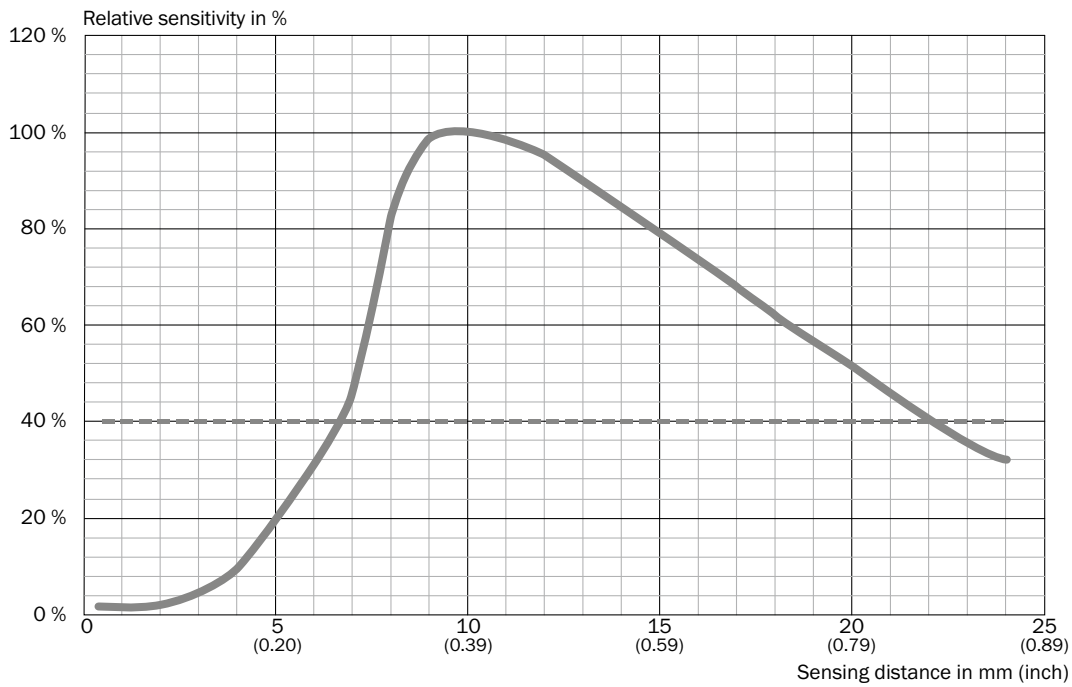

D

## Setting the switching threshold

Setting the switching threshold (static)

### 1. Position fluorescent mark

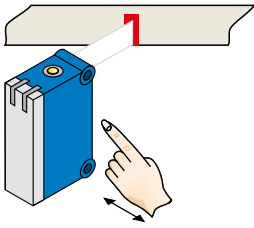

Press and hold teach-in button  $> 1 < 3$  s.  
Yellow LED flashes slowly.

### 2. Position background

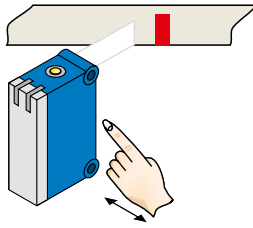

Press and hold teach-in button  $< 3$  s.  
Yellow LED goes out.

Setting the switching threshold (dynamic)

### 1. Position background

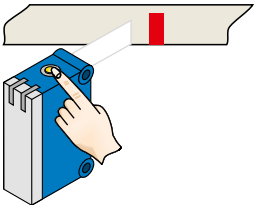

Press the teach-in button and keep it pressed. LED flashing slowly.

### 2. Move at least the fluorescent mark and background using the light spot.

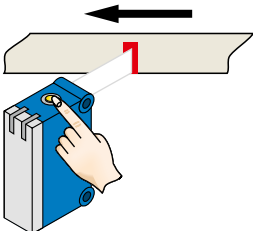

Keep the teach-in button  $> 3 < 30$  s pressed.

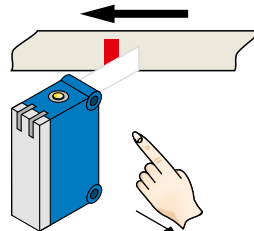

Release the teach-in button.

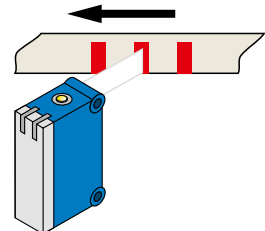

Yellow LED will illuminate, when emitted light is on the fluorescent mark.

## Sensitivity setting

Signal strength

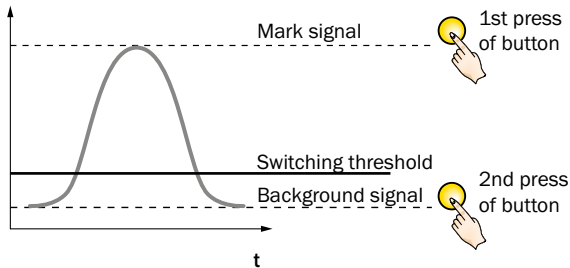

## Switching characteristics

Static teach-in: light/dark setting is defined using teach-in sequence.

Dynamic teach-in: switching output active on fluorescent mark, if background is longer in the field of view during the teach-in. The switching threshold is set automatically between the background and the mark.

Teach-in can also be performed using an external control signal (only dynamic teach-in).



Keylock activation and deactivation: hold down teach-in button  $> 30$  s.

Teach-in failure: yellow LED indicator and the transmitted light of the sensor flashing quickly.  
For dynamic teach-in with ET signal (5 Hz) via switching output Q.



## Recommended accessories

### Modules and gateways

#### Connection modules



Figure	Description	Type	Part no.
	IO-Link version V1.1, Port class 2, PIN 2, 4, 5 galvanically connected, Supply voltage 18 V DC ... 32 V DC (limit values, operation in short-circuit protected network max. 8 A)	SICK Memory Stick	1064290
	IO-Link V1.1 Class A port, USB2.0 port, optional external power supply 24V / 1A	SiLink2 Master	1061790

#### Universal bar clamp systems

Figure	Material	Description	Type	Part no.
	Steel, zinc coated	Universal clamp bracket for rod mounting	BEF-KHS-KH1	2022726
		Plate L for universal clamp bracket	BEF-KHS-L01	2023057
	Zinc plated steel (sheet), Diecast zinc (clamp)	Plate N08 for universal clamp bracket	BEF-KHS-N08	2051607
	Stainless steel 1.4571 (sheet), Stainless steel 1.4408 (clamp)	Plate N08N for universal clamp bracket	BEF-KHS-N08N	2051616

#### Mounting brackets and mounting plates

##### Mounting brackets

Figure	Material	Description	Type	Part no.
	Stainless steel	Mounting bracket for wall mounting	BEF-W100-A	5311520
	Steel, zinc coated	Mounting bracket for floor mounting	BEF-W100-B	5311521
			BEF-WN-W100-S01	4073866



##### Mounting plates

Figure	Material	Description	Type	Part no.
	Stainless steel	Adapter plate KT3 to KTM	BEF-AP-KTMS01	2068786

#### Plug connectors and cables

##### Connecting cables with female connector

##### M12, 4-pin, PVC, chemical resistant

Figure	Connection type head A	Connection type head B	Connecting cable	Type	Part no.
	Female connector, M12, 4-pin, straight, unshielded	Cable, open conductor heads	2 m, 4-wire	DOL-1204-G02M	6009382
			5 m, 4-wire	DOL-1204-G05M	6009866
	Female connector, M12, 4-pin, angled, unshielded	Cable, open conductor heads	2 m, 4-wire	DOL-1204-W02M	6009383
			5 m, 4-wire	DOL-1204-W05M	6009867

→ For additional accessories, please see page K-240

## THE SOLUTION FOR STANDARD APPLICATIONS

D



### Product description

Whether ensuring that the package insert is in the packaging or the labels are on the vial – the LUT3-6 luminescence sensor permits reliable monitoring. For

optimum adjustment to the fluorescent mark, the sensitivity of the LUT3-6 luminescence sensor is set with an infinite potentiometer.

### At a glance

- Tough metal housing
- Operating range: 0 mm ... 15 mm / 10 mm ... 35 mm / 30 mm ... 60 mm
- Sensing distances selectable through interchangeable lenses
- Transmitter LED UV (375 nm)

### Your benefits

- Sensitivity of the sensor can be infinitely adjusted using a potentiometer, saves time and reduces costs
- Filters ensure that background luminescence is reliably suppressed, ensuring greater process reliability
- Interchangeable lenses for different sensing distances provide flexibility

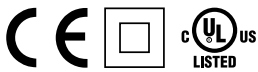

### Additional information

Detailed technical data . . . . .	D-121
Ordering information . . . . .	D-122
Dimensional drawing . . . . .	D-122
Adjustments . . . . .	D-122
Connection diagram . . . . .	D-122
Sensing distance . . . . .	D-123
Light spot size . . . . .	D-123
Setting the switching threshold . . . . .	D-123
Recommended accessories . . . . .	D-124

→ [www.sick.com/de/en/LUT3](http://www.sick.com/de/en/LUT3)

For more information, just enter the link or scan the QR code and get direct access to technical data, CAD design models, operating instructions, software, application examples and much more.





## Detailed technical data

## Features

Dimensions (W x H x D)	30.4 mm x 53 mm x 80 mm
Sensing distance	10 mm <sup>1)</sup> / 20 mm <sup>1)</sup> / 50 mm <sup>1)</sup> (depending on type)
Housing design (light emission)	Rectangular
Operating range	0 mm ... 15 mm / 10 mm ... 35 mm / 30 mm ... 60 mm (depending on type)
Light source <sup>2)</sup>	LED
Type of light	UV
Wave length	375 nm
Light emission	Long side
Light spot direction	Vertical
Receiving filters	KV 418 (standard)
Receiving range	450 nm ... 750 nm
Adjustment	Manual (potentiometer)
Output function	Light switching

<sup>1)</sup> From front edge of lens.

<sup>2)</sup> Average service life: 100,000 h at T<sub>U</sub> = +25 °C.

## Mechanics/electronics

Supply voltage <sup>1)</sup>	12 V DC ... 30 V DC
Ripple <sup>2)</sup>	< 2 V <sub>pp</sub>
Power consumption <sup>3)</sup>	< 60 mA
Switching frequency <sup>4)</sup>	1.5 kHz
Response time <sup>5)</sup>	350 μs
Switching output	PNP: HIGH = V <sub>S</sub> - ≤ 3 V / LOW = approx. 0 V NPN: HIGH = approx. V <sub>S</sub> / LOW ≤ 2 V
Output type	PNP / NPN
Output current I <sub>max.</sub>	100 mA
Connection type	Connector M12, 4-pin
Protection class <sup>6)</sup>	II
Circuit protection	V <sub>S</sub> connections reverse-polarity protected, Output Q short-circuit protected, Interference suppression
Fieldbus interface	-
Enclosure rating	IP 67
Weight	400 g
Housing material	Metal, zinc diecast

<sup>1)</sup> Limit values; operation in short-circuit protected network max. 8 A.

<sup>2)</sup> May not exceed or fall below U<sub>v</sub> tolerances.

<sup>3)</sup> Without load.

<sup>4)</sup> With light/dark ratio 1:1.

<sup>5)</sup> Signal transit time with resistive load.

<sup>6)</sup> Reference voltage DC 50 V.

## Ambient data

Ambient operating temperature	-10 °C ... +55 °C
Ambient storage temperature	-25 °C ... +75 °C
Shock load	According to IEC 60068
UL File No.	NRKH.E181493 & NRKH7.E181493

## Ordering information

Other models → [www.sick.com/de/en/LUT3](http://www.sick.com/de/en/LUT3)

Sensing distance <sup>1)</sup>	Operating range	Light spot size	Type	Part no.
10 mm	0 mm ... 15 mm	2 mm x 6 mm	LUT3-610	1015396
20 mm	10 mm ... 35 mm	3 mm x 9 mm	LUT3-620	1015397
50 mm	30 mm ... 60 mm	5 mm x 15 mm	LUT3-650	1015398

<sup>1)</sup> From front edge of lens.

## Dimensional drawing (Dimensions in mm (inch))

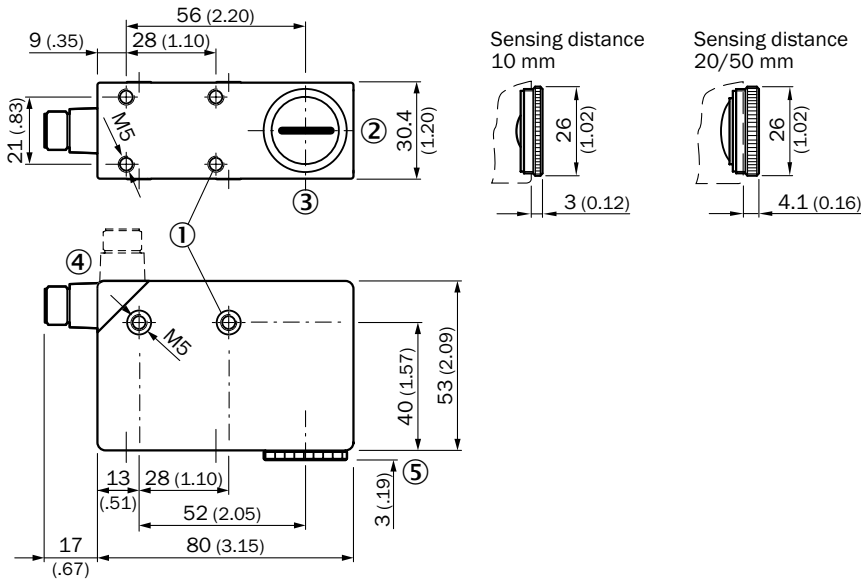

- ① M5 threaded mounting hole, 5.5 mm deep
- ② Light spot direction
- ③ Center of optical axis
- ④ Connector M12 (rotatable up to 90°)
- ⑤ See dimensional drawing for lens

## Adjustments

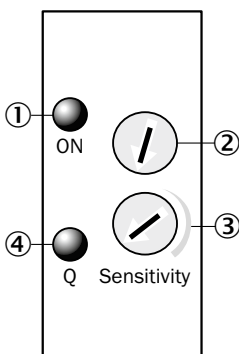

- ① Function signal indicator (green)
- ② Not connected
- ③ Sensitivity adjustment
- ④ Function signal indicator (yellow), switching output

## Connection diagram

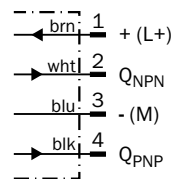

## Sensing distance

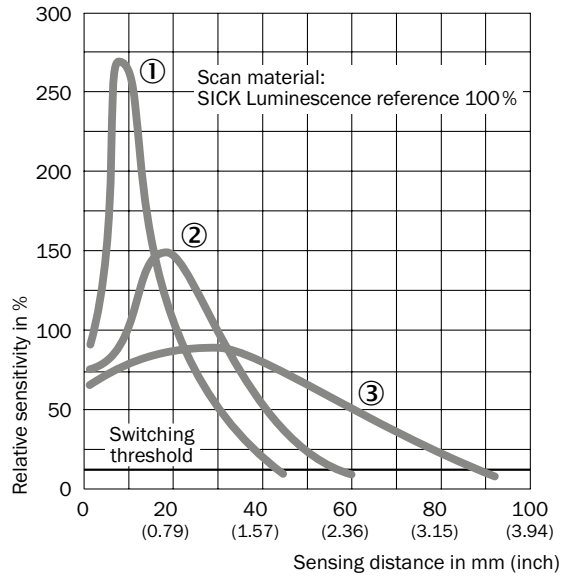

- ① Sensing distance 10 mm
- ② Sensing distance 20 mm
- ③ Sensing distance 50 mm

## Light spot size

### Sensing distance 10 mm

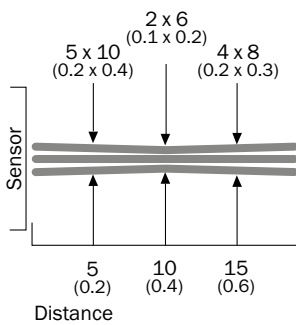

### Sensing distance 20 mm

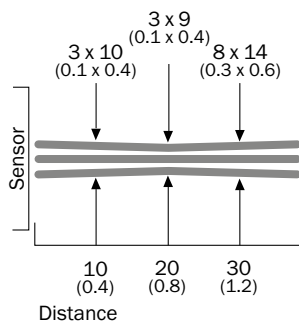

### Sensing distance 50 mm

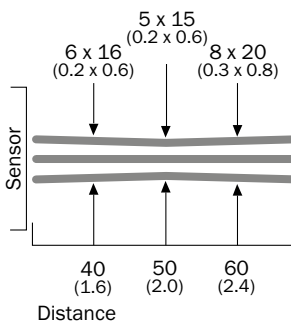

## Setting the switching threshold

Potentiometer

### 1. Position mark

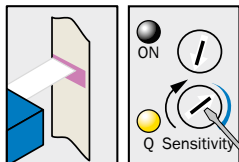

Turn "Sensitivity" rotary switch clockwise until yellow LED illuminates.

### 2. Position background

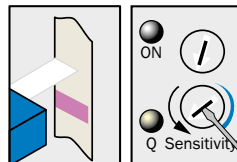

If yellow LED illuminates, turn "Sensitivity" rotary switch counter-clockwise until the yellow LED just goes out.

### Sensitivity setting

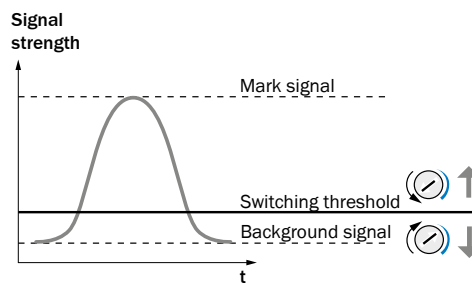

### Note

Adjustments are intended for luminescence background suppression.

Recommended accessories

Lens and accessories







Description	Diameter	Type	Part no.
Lens, 10 mm sensing distance	26 mm	OBJ-LUT3-10	2016348
Lens, 20 mm sensing distance	26 mm	OBJ-LUT3-20	2016349
Lens, 50 mm sensing distance	26 mm	OBJ-LUT3-50	2016350

Reference materials

Material	Description	Type	Part no.
Crayon	Crayon, red fluorescence	LUM-FT	1004460
Writing chalk	Writing chalk, red fluorescence	LUM-KLK	1002959

Universal bar clamp systems



D

Figure	Material	Description	Type	Part no.
	Steel, zinc coated	Plate G for universal clamp bracket	BEF-KHS-G01	2022464
		Plate K for universal clamp bracket	BEF-KHS-K01	2022718
		Universal clamp bracket for rod mounting	BEF-KHS-KH1	2022726
		Mounting bar, straight, 200 mm, steel	BEF-MS12G-A	4056054
		Mounting bar, straight, 300 mm, steel	BEF-MS12G-B	4056055
		Mounting bar, L-shaped, 150 mm x 150 mm, steel	BEF-MS12L-A	4056052
		Mounting bar, L-shaped, 250 x 250 mm, steel	BEF-MS12L-B	4056053

Plug connectors and cables

Connecting cables with female connector

M12, 4-pin, PVC, chemical resistant

Figure	Connection type head A	Connection type head B	Connecting cable	Type	Part no.
	Female connector, M12, 4-pin, straight, unshielded	Cable, open conductor heads	2 m, 4-wire	DOL-1204-G02M	6009382
			5 m, 4-wire	DOL-1204-G05M	6009866
	Female connector, M12, 4-pin, angled, unshielded	Cable, open conductor heads	2 m, 4-wire	DOL-1204-W02M	6009383
			5 m, 4-wire	DOL-1204-W05M	6009867

→ For additional accessories, please see page K-240

**D**

## FOR UNIVERSAL USE WITH EASY ADJUSTMENT

D



## Additional information

Detailed technical data . . . . .	D-127
Ordering information . . . . .	D-128
Dimensional drawing . . . . .	D-128
Adjustments . . . . .	D-129
Connection diagram . . . . .	D-129
Sensing distance . . . . .	D-129
Light spot size . . . . .	D-129
Setting the switching threshold . . . . .	D-130
Recommended accessories . . . . .	D-130

## Product description

The strength of the LUT8 is its straightforward operating concept. The sensitivity of the LUT8, and the switching reliability, can easily be adapted to the mark to be detected with the help of the

8-position rotary switch. An additional advantage is the bar graph display which visualizes the luminescence intensity of the mark and that of the background.

## At a glance

- Tough metal housing
- Simple sensitivity adjustment in 8 stages
- Bar graph display provides information about the luminescence intensity
- Sensing distances selectable through interchangeable lenses
- Additional optical filters suppress background luminescence
- Fiber-optic cable connection (with 20 mm lens)
- Switching and analog output
- Operating range: 0 mm ... 20 mm / 10 mm ... 40 mm / 20 mm ... 70 mm / 30 mm ... 110 m

## Your benefits

- An 8-step rotary switch easily adjusts to accurately determine the switching output position for different materials
- Bar graph display provides continual process control through easy visualization of the luminescence intensity
- Filters ensure that background luminescence is reliably suppressed, ensuring greater process reliability
- Interchangeable lenses for different sensing distances provide flexibility

→ [www.sick.com/de/en/LUT8](http://www.sick.com/de/en/LUT8)

For more information, just enter the link or scan the QR code and get direct access to technical data, CAD design models, operating instructions, software, application examples and much more.



## Detailed technical data

## Features

<b>Dimensions (W x H x D)</b>	30.4 mm x 53 mm x 80 mm
<b>Sensing distance <sup>1)</sup></b>	10 mm / 20 mm / 50 mm / 90 mm (depending on type)
<b>Housing design (light emission)</b>	Rectangular
<b>Operating range</b>	0 mm ... 20 mm / 10 mm ... 40 mm / 20 mm ... 70 mm / 30 mm ... 110 mm (depending on type)
<b>Light source <sup>2)</sup></b>	LED
<b>Type of light</b>	UV
<b>Wave length</b>	375 nm
<b>Light emission</b>	Long side
<b>Light spot direction</b>	Vertical
<b>Receiving range</b>	450 nm ... 750 nm (depending on type)
<b>Adjustment</b>	Manual (rotary switch)
<b>Output function</b>	Light switching

<sup>1)</sup> From front edge of lens.

<sup>2)</sup> Average service life: 100,000 h at  $T_U = +25\text{ °C}$ .

## Mechanics/electronics

<b>Supply voltage <sup>1)</sup></b>	12 V DC ... 30 V DC
<b>Ripple <sup>2)</sup></b>	$< 5 V_{pp}$
<b>Power consumption <sup>3)</sup></b>	$< 100\text{ mA}$
<b>Switching frequency <sup>4)</sup></b>	2.5 kHz
<b>Response time <sup>5)</sup></b>	200 $\mu\text{s}$
<b>Switching output</b>	PNP: HIGH = $V_S - \leq 3\text{ V}$ / LOW = approx. 0 V NPN: HIGH = approx. $V_S$ / LOW $\leq 2\text{ V}$
<b>Output type</b>	PNP / NPN
<b>Analog output <math>Q_A</math></b>	0 mA ... 13 mA
<b>Output current <math>I_{max.}</math></b>	100 mA
<b>Connection type</b>	Connector M12, 5-pin
<b>Protection class <sup>6)</sup></b>	II
<b>Circuit protection</b>	$V_S$ connections reverse-polarity protected, Output Q short-circuit protected, Interference suppression
<b>Fieldbus interface</b>	-
<b>Enclosure rating</b>	IP 67
<b>Weight</b>	400 g
<b>Housing material</b>	Metal, zinc diecast

<sup>1)</sup> Limit values; operation in short-circuit protected network max. 8 A.

<sup>2)</sup> May not exceed or fall below  $U_v$  tolerances.

<sup>3)</sup> Without load.

<sup>4)</sup> With light/dark ratio 1:1.

<sup>5)</sup> Signal transit time with resistive load.

<sup>6)</sup> Reference voltage DC 50 V.

## Ambient data

<b>Ambient operating temperature</b>	-10 °C ... +55 °C
<b>Ambient storage temperature</b>	-25 °C ... +75 °C
<b>Shock load</b>	According to IEC 60068

Ordering information

Other models → [www.sick.com/de/en/LUT8](http://www.sick.com/de/en/LUT8)

Sensing distance <sup>1)</sup>	Operating range	Light spot size	Receiving filters	Receiving range	Type	Part no.
10 mm	0 mm ... 20 mm	2 mm x 6 mm	KV 418 (standard)	450 nm ... 750 nm	LUT8U-11101	1046711
20 mm	10 mm ... 40 mm	3 mm x 9 mm	KV 418 (standard)	450 nm ... 750 nm	LUT8U-11201	1047042
50 mm	20 mm ... 70 mm	5 mm x 15 mm	KV 418 (standard)	450 nm ... 750 nm	LUT8U-11301	1047043
			OG 570	570 nm ... 750 nm	LUT8U-11311	1047045
			RG 610	610 nm ... 750 nm	LUT8U-11321	1047046
			RG 665	670 nm ... 750 nm	LUT8U-11331	1047047
			KV 418 (standard)	450 nm ... 750 nm	LUT8U-11701	1047048
90 mm	30 mm ... 110 mm	12 mm x 12 mm	KV 418 (standard)	450 nm ... 750 nm	LUT8U-11401	1047044

<sup>1)</sup> From front edge of lens.

D

Dimensional drawing (Dimensions in mm (inch))

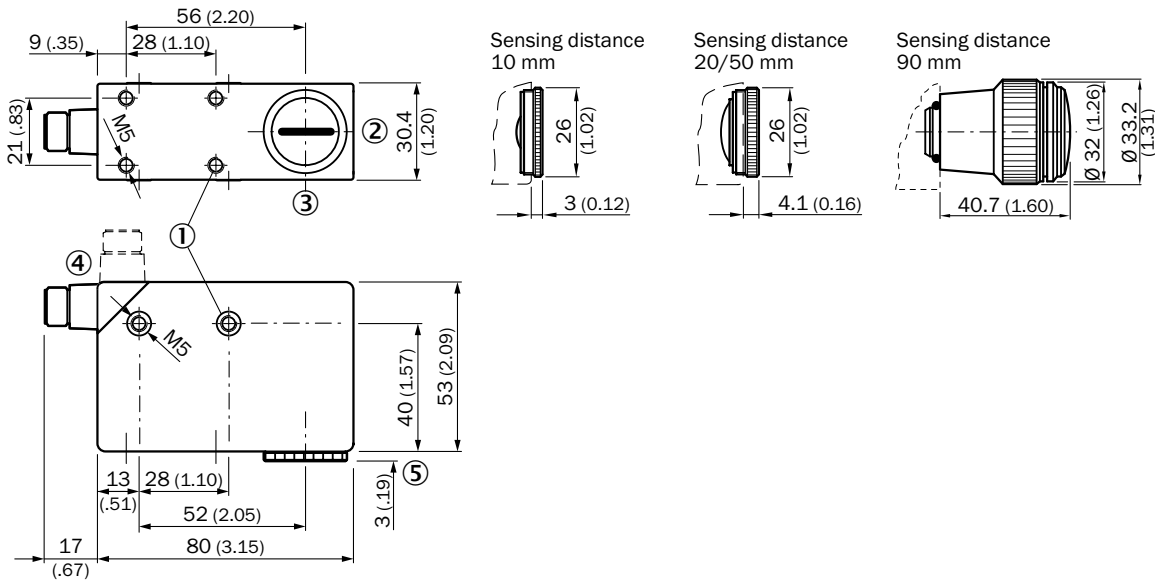

- ① M5 threaded mounting hole, 5.5 mm deep
- ② Light spot direction
- ③ Center of optical axis
- ④ Connector M12 (rotatable up to 90°)
- ⑤ See dimensional drawing for lens



### Adjustments

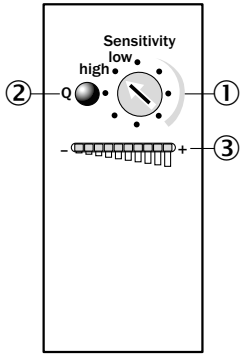

- ① Rotary selection switch
- ② Function signal indicator (yellow), switching output
- ③ Bar graph (green), Power on left LED

### Connection diagram

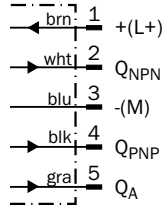

### Sensing distance

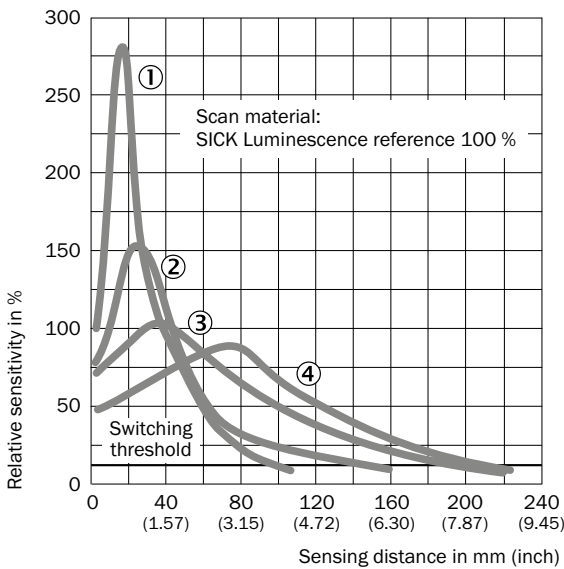

- ① Sensing distance 10 mm
- ② Sensing distance 20 mm
- ③ Sensing distance 50 mm
- ④ Sensing distance 90 mm

### Light spot size

#### Sensing distance 10 mm

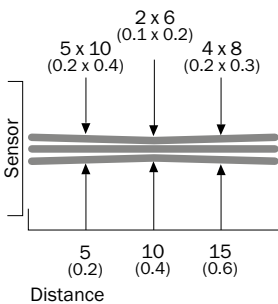

#### Sensing distance 20 mm

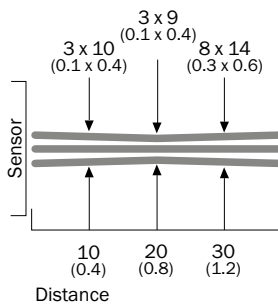

#### Sensing distance 50 mm

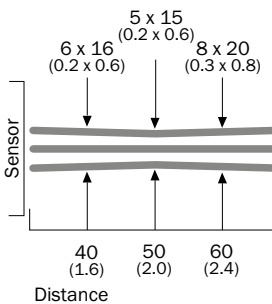

#### Sensing distance 90 mm

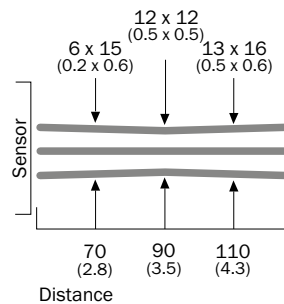

All dimensions in mm (inch)

## Setting the switching threshold

Rotary switch

### 1. Position mark

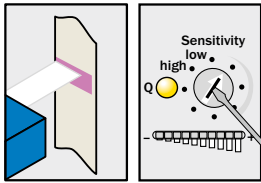

Turn "Sensitivity" rotary switch clockwise until yellow LED illuminates.

### 2. Position background

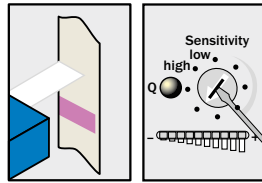

If yellow LED illuminates, turn "Sensitivity" rotary switch counter-clockwise until the yellow LED just goes out.

### Sensitivity setting

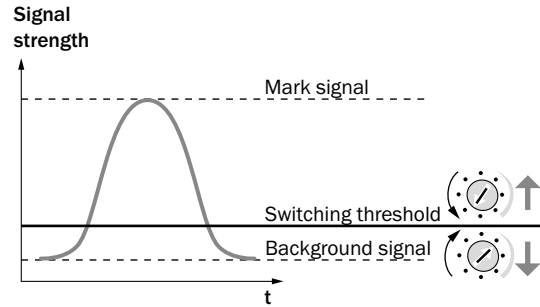

### Note

The bar graph display shows the luminescence intensity (regardless of switching threshold setting). Adjustments are intended for luminescence background suppression.

## Recommended accessories

### Lens and accessories

Description	Diameter	Type	Part no.
Lens, 10 mm sensing distance	26 mm	OBJ-LUT3-10	2016348
Lens, 20 mm sensing distance	26 mm	OBJ-LUT3-20	2016349
Lens, 50 mm sensing distance	26 mm	OBJ-LUT3-50	2016350

### Reference materials

Material	Description	Type	Part no.
Crayon	Crayon, red fluorescence	LUM-FT	1004460
Writing chalk	Writing chalk, red fluorescence	LUM-KLK	1002959



### Universal bar clamp systems

Figure	Material	Description	Type	Part no.
	Steel, zinc coated	Plate G for universal clamp bracket	BEF-KHS-G01	2022464
		Plate K for universal clamp bracket	BEF-KHS-K01	2022718
		Universal clamp bracket for rod mounting	BEF-KHS-KH1	2022726
		Mounting bar, straight, 200 mm, steel	BEF-MS12G-A	4056054
		Mounting bar, straight, 300 mm, steel	BEF-MS12G-B	4056055
		Mounting bar, L-shaped, 150 mm x 150 mm, steel	BEF-MS12L-A	4056052
		Mounting bar, L-shaped, 250 x 250 mm, steel	BEF-MS12L-B	4056053

## Plug connectors and cables

Connecting cables with female connector

M12, 5-pin, PVC, chemical resistant

Figure	Connection type head A	Connection type head B	Connecting cable	Type	Part no.
	Female connector, M12, 5-pin, straight, unshielded	Cable, open conductor heads	2 m, 5-wire	DOL-1205-G02M	6008899
			5 m, 5-wire	DOL-1205-G05M	6009868
	Female connector, M12, 5-pin, angled, unshielded	Cable, open conductor heads	2 m, 5-wire	DOL-1205-W02M	6008900
			5 m, 5-wire	DOL-1205-W05M	6009869

→ For additional accessories, please see page K-240

D

# THE NEW STANDARD FOR HIGH-PERFORMANCE LUMINESCENCE SENSORS

D



 **IO-Link**



## Additional information

Detailed technical data . . . . .	D-133
Ordering information . . . . .	D-134
Dimensional drawings . . . . .	D-135
Adjustments . . . . .	D-136
Connection diagram . . . . .	D-136
Sensing distance . . . . .	D-137
Light spot size . . . . .	D-137
Setting the switching threshold	D-138
Recommended accessories . . .	D-139

## Product description

The LUT9 luminescence sensor offers a long sensing distance and remote monitoring capabilities via IO-Link. With a sensing distance of up to 250 mm, the LUT9 sets a new standard for luminescence sensors. Due to the long distances possible between the sensor and the object, marks on lumber with varying thicknesses, for example, can be reliably detected without mechanical adjustment of the sensors. In

addition, the teach function and manual fine adjustment allow for maximum process reliability. The LUT9 version with IO-Link can actively be integrated into the machine control logic, configured/monitored from the controller, and used for process data collection. Especially helpful is a bar graph display on the device indicating the luminescence intensity.

## At a glance

- Simple teach-in
- Operating range up to 250 mm
- Version with IO-Link for remote monitoring
- Bar graph display provides information about the luminescence intensity
- High speed (6.5 kHz), standard (2.5 kHz), high resolution (500 Hz) models
- Additional optical filters suppress background luminescence
- Fiber-optic cable connection (with 20 mm lens)
- Switching and analog output

## Your benefits

- Simple sensitivity adjustment via teach-in for optimum adaptation to the application
- Long sensing distance tolerance leads to less mechanical height adjustments of the sensor on the machine
- Using IO-Link, the sensor can be configured and monitored by the central control system, enabling simple, cost-effective diagnostics and data collection
- Bar graph display provides continual process control through easy visualization of the luminescence intensity
- Filters ensure that background luminescence is reliably suppressed, ensuring greater process reliability
- Interchangeable lenses for different sensing distances and the second light exit provide flexibility
- High detection reliability ensures the process and reduces downtime
- Select speed or high resolution, making it ideal for any application.

→ [www.sick.com/de/en/LUT9](http://www.sick.com/de/en/LUT9)

For more information, just enter the link or scan the QR code and get direct access to technical data, CAD design models, operating instructions, software, application examples and much more.



## Detailed technical data

## Features

<b>Dimensions (W x H x D)</b>	30.4 mm x 53 mm x 80 mm
<b>Sensing distance <sup>1)</sup></b>	10 mm / 20 mm / 50 mm / 90 mm / 150 mm (depending on type)
<b>Housing design (light emission)</b>	Rectangular
<b>Light source <sup>2)</sup></b>	LED
<b>Type of light</b>	UV / visible blue light (depending on type)
<b>Wave length</b>	470 nm / 375 nm (depending on type)
<b>Light emission</b>	Long side / Long and short side, exchangeable (depending on type)
<b>Light spot direction</b>	Vertical
<b>Receiving range</b>	450 nm ... 750 nm (depending on type)
<b>Adjustment</b>	Static 2-point teach-in with manual fine adjustment / IO-Link (optional) (depending on type)
<b>Output function <sup>3)</sup></b>	Light switching

<sup>1)</sup> From front edge of lens.

<sup>2)</sup> Average service life: 100,000 h at  $T_U = +25\text{ °C}$ .

<sup>3)</sup> L/D switching via teach-in or IO-Link.

## Mechanics/electronics

<b>Supply voltage <sup>1)</sup></b>	10 V DC ... 30 V DC
<b>Ripple <sup>2)</sup></b>	$< 5 V_{pp}$
<b>Power consumption <sup>3)</sup></b>	$< 100\text{ mA}$
<b>Switching frequency <sup>4)</sup></b>	0.5 kHz / 2.5 kHz / 6.5 kHz, adjustable
<b>Response time <sup>5)</sup></b>	1 ms, 200 $\mu\text{s}$ , 75 $\mu\text{s}$
<b>Switching output</b>	PNP: HIGH = $V_S - \leq 2\text{ V}$ / LOW approx. 0 V NPN: HIGH = approx. $V_S$ / LOW $\leq 2\text{ V}$
<b>Output type</b>	PNP / NPN
<b>Analog output <math>Q_A</math></b>	0 mA ... 13 mA
<b>Output current <math>I_{max.}</math></b>	100 mA
<b>Time delay</b>	0 ms / 10 ms / 20 ms, adjustable
<b>Connection type</b>	Connector M12, 5-pin / Connector M12, 4-pin (depending on type)
<b>Protection class <sup>6)</sup></b>	II
<b>Circuit protection</b>	$V_S$ connections reverse-polarity protected, Output Q short-circuit protected, Interference suppression
<b>Fieldbus interface</b>	- / IO-Link (depending on type)
<b>Enclosure rating</b>	IP 67
<b>Weight</b>	400 g
<b>Housing material</b>	Metal, zinc diecast

<sup>1)</sup> Limit values; operation in short-circuit protected network max. 8 A.

<sup>2)</sup> May not exceed or fall below  $U_V$  tolerances.

<sup>3)</sup> Without load.

<sup>4)</sup> With light/dark ratio 1:1, no time delay.

<sup>5)</sup> Signal transit time with resistive load.

<sup>6)</sup> Reference voltage DC 50 V.

## Ambient data

<b>Ambient operating temperature</b>	-10 °C ... +55 °C
<b>Ambient storage temperature</b>	-25 °C ... +75 °C
<b>Shock load</b>	According to IEC 60068

Ordering information

Other models → [www.sick.com/de/en/LUT9](http://www.sick.com/de/en/LUT9)

Sensing distance: 10 mm

- **Light spot size:** 2 mm x 6 mm
- **Operating range:** 0 mm ... 20 mm

Type of light	Light emission	Receiving range	Output type	Fieldbus interface	Connection	Connection diagram	Type	Part no.
Ultraviolet light	Long side	450 nm ... 750 nm	PNP/NPN	-	Connector M12, 5-pin	Cd-312	LUT9U-11106	1047049

Sensing distance: 20 mm

- **Light spot size:** 3 mm x 9 mm
- **Operating range:** 10 mm ... 40 mm

Type of light	Light emission	Receiving range	Output type	Fieldbus interface	Connection	Connection diagram	Type	Part no.
Ultraviolet light	Long side	450 nm ... 750 nm	PNP/NPN	-	Connector M12, 5-pin	Cd-312	LUT9U-11206	1047050
	Long and short side, exchangeable	450 nm ... 750 nm	PNP/NPN	-	Connector M12, 5-pin	Cd-321	LUT9U-12206	1046749
	Long side	450 nm ... 750 nm	PNP	IO-Link	Connector M12, 4-pin	Cd-321	LUT9U-P120L	1046188

Sensing distance: 50 mm

- **Light spot size:** 5 mm x 15 mm
- **Operating range:** 20 mm ... 70 mm

Type of light	Light emission	Receiving range	Output type	Fieldbus interface	Connection	Connection diagram	Type	Part no.
Ultraviolet light	Long side	450 nm ... 750 nm	PNP/NPN	-	Connector M12, 5-pin	Cd-312	LUT9U-11306	1046712
		570 nm ... 750 nm	PNP/NPN	-	Connector M12, 5-pin	Cd-312	LUT9U-11316	1047052
		610 nm ... 750 nm	PNP/NPN	-	Connector M12, 5-pin	Cd-312	LUT9U-11326	1047053
		670 nm ... 750 nm	PNP/NPN	-	Connector M12, 5-pin	Cd-312	LUT9U-11336	1047054
	Long and short side, exchangeable	450 nm ... 750 nm	PNP/NPN	-	Connector M12, 5-pin	Cd-321	LUT9U-12306	1047055
	Long side	450 nm ... 750 nm	PNP	IO-Link	Connector M12, 4-pin	Cd-321	LUT9U-P130L	1045606

Sensing distance: 90 mm

- **Light spot size:** 12 mm x 12 mm
- **Operating range:** 30 mm ... 110 mm

Type of light	Light emission	Receiving range	Output type	Fieldbus interface	Connection	Connection diagram	Type	Part no.
Ultraviolet light	Long side	450 nm ... 750 nm	PNP/NPN	-	Connector M12, 5-pin	Cd-312	LUT9U-11406	1047051

Sensing distance: 150 mm

- **Light spot size:** 5 mm x 12 mm
- **Operating range:** 50 mm ... 250 mm

Type of light	Light emission	Receiving range	Output type	Fieldbus interface	Connection	Connection diagram	Type	Part no.
Ultraviolet light	Long side	450 nm ... 750 nm	PNP/NPN	-	Connector M12, 5-pin	Cd-312	LUT9U-11606	1047414
Visible blue light	Long side	610 nm ... 750 nm	PNP/NPN	-	Connector M12, 5-pin	Cd-312	LUT9B-11626	1047056

**Dimensional drawings** (Dimensions in mm (inch))

LUT9x-x1xxx, light Emission: Long side

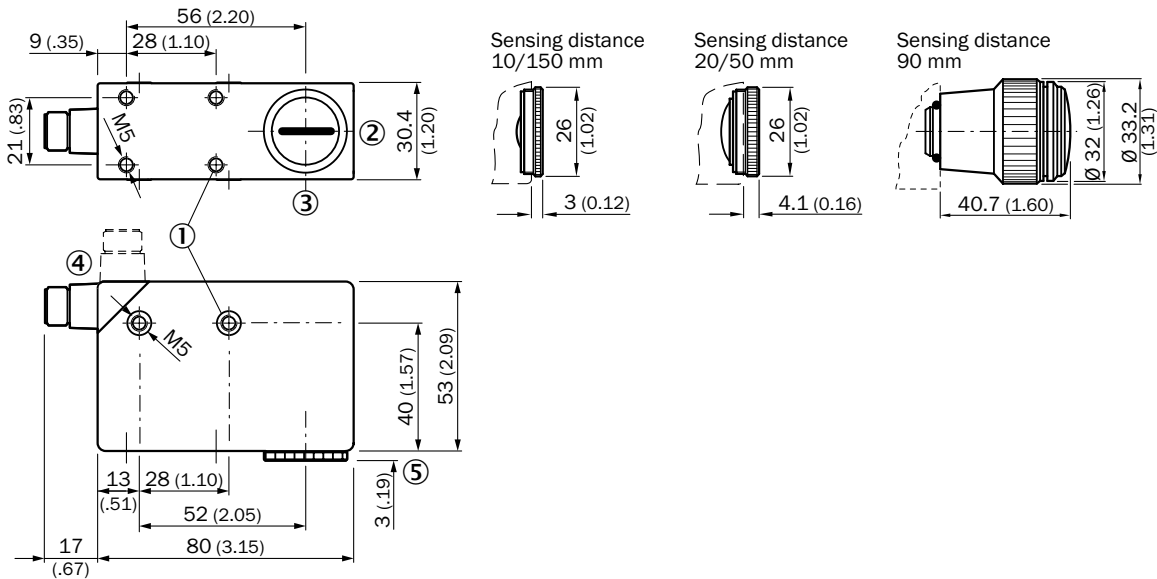

- ① M5 threaded mounting hole, 5.5 mm deep
- ② Lens (light transmission), can be replaced by blind screw
- ③ Center of optical axis
- ④ Connector M12 (rotatable up to 90°)
- ⑤ See dimensional drawing for lens
- ⑥ Blind screw can be replaced by lens

D

LUT9x-x2xxx, light emission: long and short side, exchangeable

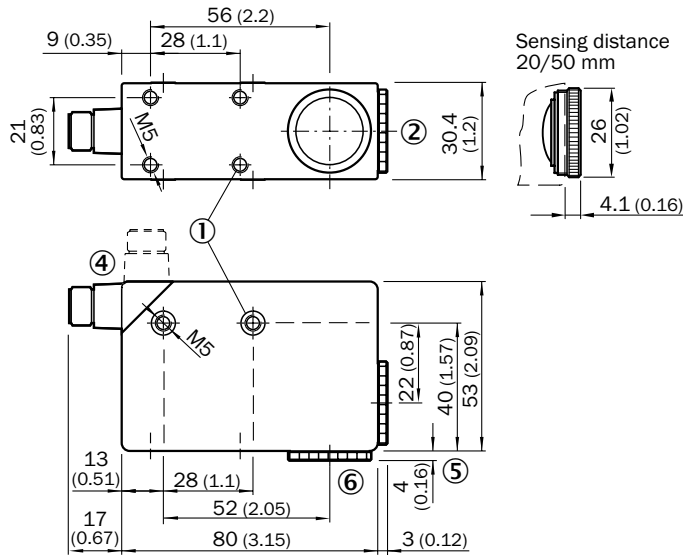

D

- ① M5 threaded mounting hole, 5.5 mm deep
- ② Lens (light transmission), can be replaced by blind screw
- ④ Connector M12 (rotatable up to 90°)
- ⑤ See dimensional drawing for lens
- ⑥ Blind screw can be replaced by lens

### Adjustments

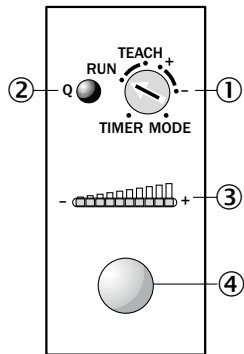

- ① Rotary selection switch
- ② Function signal indicator (yellow), switching output
- ③ Bar graph (green), Power on left LED
- ④ Teach-in button

### Connection diagram

Cd-312

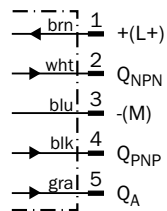

Cd-321

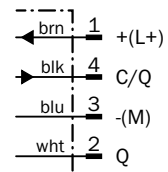



Sensing distance

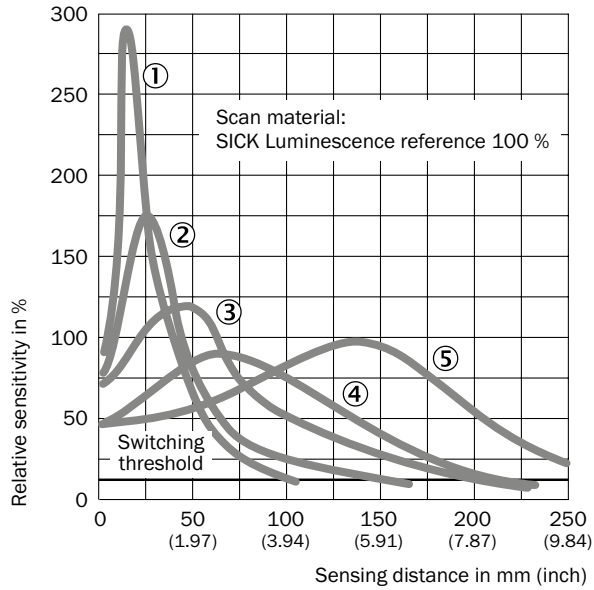

- ① Sensing distance 10 mm
- ② Sensing distance 20 mm
- ③ Sensing distance 50 mm
- ④ Sensing distance 90 mm
- ⑤ Sensing distance 150 mm

Light spot size

Sensing distance 10 mm

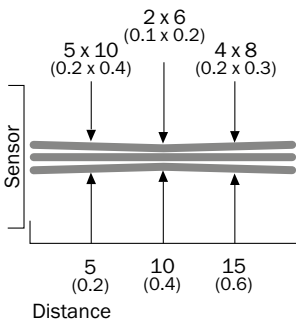

Sensing distance 20 mm

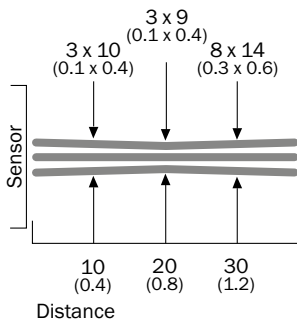

Sensing distance 50 mm

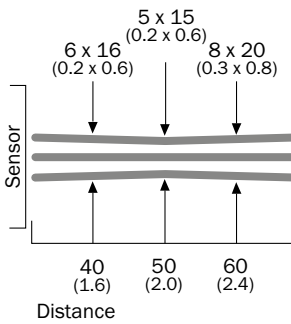

Sensing distance 90 mm

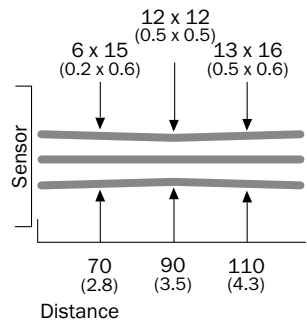

Sensing distance 150 mm

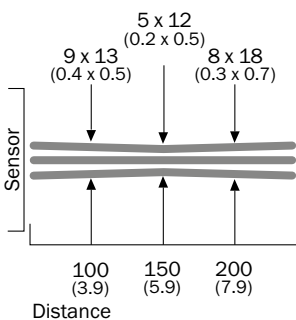

All dimensions in mm (inch)

### Setting the switching threshold

Button +/-

#### 1. Position mark

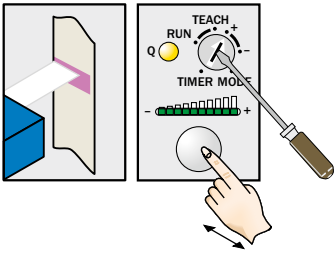

Turn rotary switch to “+” position and press and hold teach-in button until yellow light goes out (more green LEDs illuminate on the bar display).

#### 2. Position background

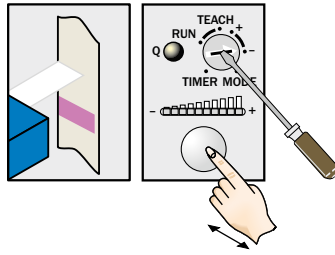

If yellow LED illuminates, turn rotary switch to “-” position and press and hold teach-in button until yellow light just goes out (green LEDs go out on the bar display).

#### Sensitivity setting

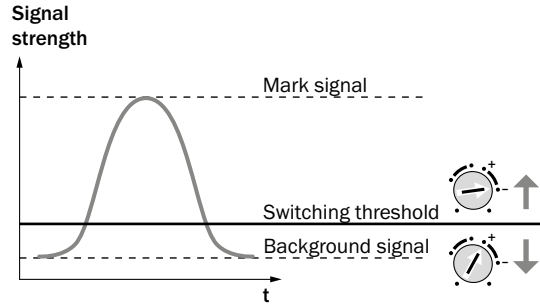

D

#### Note for all settings

Once configuration is complete, turn the rotary switch to the “RUN” position. The bar display then shows the luminescence intensity (regardless of switching threshold setting).

Adjustments are intended for luminescence background suppression.

Teach-in static

#### 1. Position mark

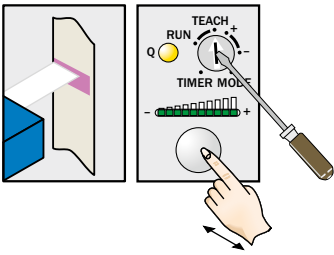

Turn rotary switch to “TEACH” position and press and hold teach-in button > 1 s. Yellow LED flashes slowly.

#### 2. Position background

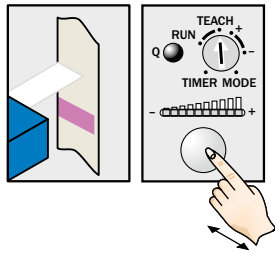

Press and hold teach-in button again > 1 s. Yellow LED goes out.

#### Sensitivity setting

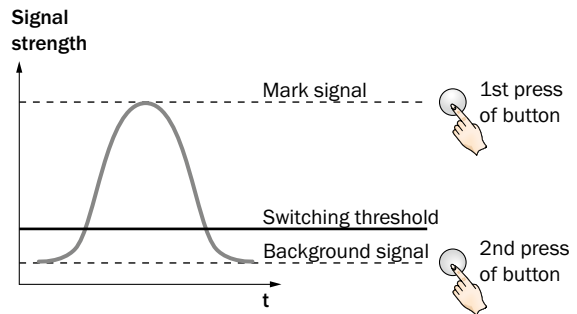



#### Note

The bar graph display shows detection reliability. The more LEDs that illuminate, the better the teach-in.

## Recommended accessories

### Modules and gateways

#### Connection modules

Figure	Description	Type	Part no.
	IO-Link version V1.1, Port class 2, PIN 2, 4, 5 galvanically connected, Supply voltage 18 V DC ... 32 V DC (limit values, operation in short-circuit protected network max. 8 A)	SICK Memory Stick	1064290
	IO-Link V1.1 Class A port, USB2.0 port, optional external power supply 24V / 1A	SiLink2 Master	1061790







#### Lens and accessories

Description	Diameter	Type	Part no.
Lens, 10 mm sensing distance	26 mm	OBJ-LUT3-10	2016348
Lens, 20 mm sensing distance	26 mm	OBJ-LUT3-20	2016349
Lens, 50 mm sensing distance	26 mm	OBJ-LUT3-50	2016350

#### Reference materials

Material	Description	Type	Part no.
Crayon	Crayon, red fluorescence	LUM-FT	1004460
Writing chalk	Writing chalk, red fluorescence	LUM-KLK	1002959



#### Universal bar clamp systems

Figure	Material	Description	Type	Part no.
	Steel, zinc coated	Plate G for universal clamp bracket	BEF-KHS-G01	2022464
		Plate K for universal clamp bracket	BEF-KHS-K01	2022718
		Universal clamp bracket for rod mounting	BEF-KHS-KH1	2022726
		Mounting bar, straight, 200 mm, steel	BEF-MS12G-A	4056054
		Mounting bar, straight, 300 mm, steel	BEF-MS12G-B	4056055
		Mounting bar, L-shaped, 150 mm x 150 mm, steel	BEF-MS12L-A	4056052
		Mounting bar, L-shaped, 250 x 250 mm, steel	BEF-MS12L-B	4056053



#### Plug connectors and cables

##### Connecting cables with female connector

##### M12, 4-pin, PVC, chemical resistant

Figure	Connection type head A	Connection type head B	Connecting cable	Type	Part no.
	Female connector, M12, 4-pin, straight, unshielded	Cable, open conductor heads	2 m, 4-wire	DOL-1204-G02M	6009382
			5 m, 4-wire	DOL-1204-G05M	6009866
	Female connector, M12, 4-pin, angled, unshielded	Cable, open conductor heads	2 m, 4-wire	DOL-1204-W02M	6009383
			5 m, 4-wire	DOL-1204-W05M	6009867

M12, 5-pin, PVC, chemical resistant

Figure	Connection type head A	Connection type head B	Connecting cable	Type	Part no.
	Female connector, M12, 5-pin, straight, unshielded	Cable, open conductor heads	2 m, 5-wire	DOL-1205-G02M	6008899
			5 m, 5-wire	DOL-1205-G05M	6009868
	Female connector, M12, 5-pin, angled, unshielded	Cable, open conductor heads	2 m, 5-wire	DOL-1205-W02M	6008900
			5 m, 5-wire	DOL-1205-W05M	6009869

→ For additional accessories, please see page K-240

D

**D**



## E GLARE SENSORS



### Gloss and performance combined

The Glare sensor detects and distinguishes glare on even surfaces. It also provides maximum reliability and saves costs. Previously, gloss on object surfaces was a disruptive factor that regularly had engineers breaking into a sweat.

Now, gloss properties are a distinguishing criterion for process control – regardless of color, transparency or pattern. And it will be engineers' eyes that shine, not their brows. Equipped with intelligent Delta-S-Technology, Glare is a

further milestone in customer-oriented sensor development. Once again, SICK is confirming its leading position in optoelectronic sensors for the detection of a range of objects.



E

General information . . . . .	E-144
Product family overview . . . . .	E-149



Glare . . . . .	E-150
The authority on gloss	

## REDEFINING POLISHED PERFORMANCE

Star players are usually applauded for a good performance, so glare sensor from SICK should expect a standing ovation or two. Its performance in detecting and distinguishing between different gloss levels is truly award-worthy.

Previously, gloss on object surfaces was a disruptive factor that regularly had engineers breaking into a sweat. Now, gloss properties are a distinguishing criterion for process control – regardless of color, transparency, or pattern. And it will be engineers' eyes that shine, not

their brows. Equipped with intelligent Delta-S-Technology, Glare is a further milestone in sensor development. Once again, SICK confirms its leading position in opto-electronic sensors for the detection of a range of objects.

E







## GLOSS AND PERFORMANCE COMBINED

Glare checks for the presence of glossy objects, regardless of color, transparency, or pattern. The principle of operation is as simple as it is innovative – sheer technological brilliance. This results in exceptionally high process reliability with very low material, installation, and configuration outlay. In inspection tasks, Glare is therefore the cost-efficient alternative to complex camera systems.

E

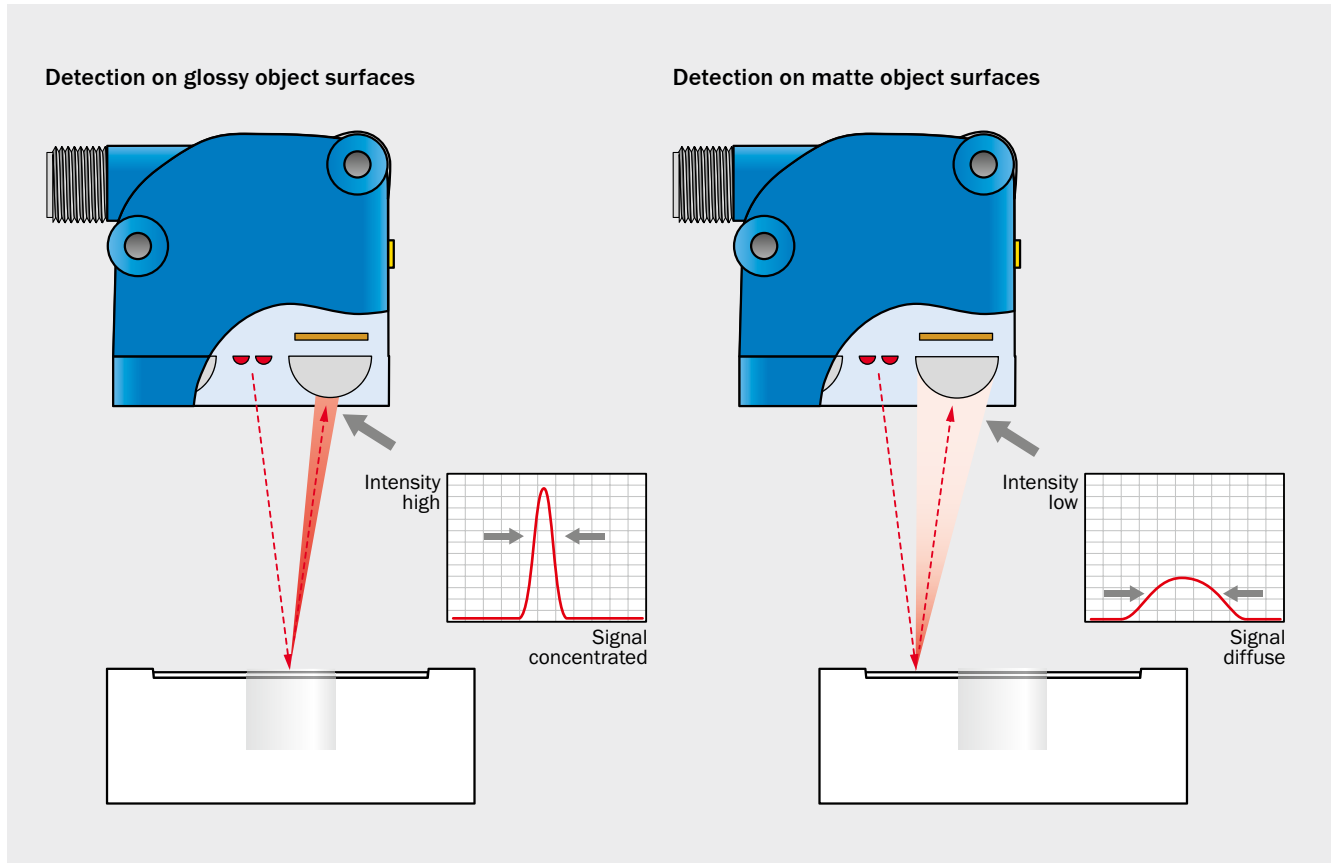

At a defined angle, visible red light lands on the object to be detected. Depending on the gloss level of the surface, it throws back the light beam with a different intensity and scatter. This information is recorded and analyzed via two high-resolution line sensors with the patented Delta-S-Technology.

Glare's strengths also include simple installation and commissioning with the SOPAS configuration software and intelligent communication with additional benefits via the IO-Link interface. This results in exceptionally high process reliability with very low material, installation, and configuration outlay. In inspection tasks, Glare is therefore the cost-efficient alternative to complex camera systems.

## TYPICAL APPLICATIONS



### Detecting authenticity features

To protect products against tampering, authenticity features such as seals, holograms, and labels are added to packages before they leave production. Steps must be taken to guarantee that these features are indeed added, for example for medications. If the glare of a feature differs from the packaging material, Glare will reliably detect it – even if a packaging design or writing appears underneath the seal.



### Detecting coatings

The gloss level of moist or dry coatings such as oils, adhesives, and paints differs from that of an object's other, non-coated surfaces. Glare verifies that these coatings have been applied correctly, ensuring quality in the production process.



### Detecting different surface treatments

Smoothing, cleaning, and polishing materials affects their surface structure and, therefore, their gloss properties. Glare checks these surface treatments.



### Detecting protective packaging

Outer packaging for products and protective films for sensitive surfaces are generally made from transparent or glossy materials. Glare reliably verifies the presence of such protective packaging, ensuring an error-free packaging process.

E

## PRODUCT FAMILY OVERVIEW



**Glare**

The authority on gloss

### Technical data overview

Sensing range	50 mm
Type of light	Visible red light
Light spot size	10 mm x 12 mm
Adjustment	Static 1-point teach-in Static 2-point teach-in 2-point teach-in dynamic Static 3-point teach-in
Connection type	Connector M12, 5-pin

### At a glance

- Object detection and differentiation on the basis of surface gloss level
- Configurable in many different operating modes to meet the requirements of any application
- Integrated alignment aid
- Integrated automation functions
- Two digital push-pull outputs and one configurable input
- Sensitivity adjusts to object properties
- IO-Link provides easy data access from the PLC
- Quick and easy configuration

### Detailed information

→ E-150

E



# THE AUTHORITY ON GLOSS

E



### Additional information

Detailed technical data . . . . . E-151  
 Ordering information . . . . . E-152  
 Dimensional drawing . . . . . E-153  
 Connection diagram . . . . . E-153  
 Recommended accessories . . . . E-154

### Product description

The Glare sensor is specially designed to recognize and differentiate objects on the basis of their gloss in order to control production processes. The Glare sensor analyzes the spatial distribution of reflected light using Delta-S technology, which allows the sensor to determine the gloss level of flat object surfaces and to differentiate between objects of differing gloss levels. The measurement result is transmitted to the process controls either via two digital switching outputs or IO-Link. Several operating

modes are available, making the Glare sensor perfectly suited to a range of different applications. The combination of intelligent signal evaluation algorithms, the multi-sensor arrangement and sensitivity adjustments ensure increased operational safety in industrial applications. The Glare's IO-Link interface enables the sensor to be integrated into the machine controller, featuring automatic, process-oriented configuration and online diagnostics.

### At a glance

- Object detection and differentiation on the basis of surface gloss level
- Configurable in many different operating modes to meet the requirements of any application
- Integrated alignment aid
- Integrated automation functions
- Two digital push-pull outputs and one configurable input
- Sensitivity adjusts to object properties
- IO-Link provides easy data access from the PLC
- Quick and easy configuration

### Your benefits

- Quick installation via alignment mode
- Integrated key lock reduces the risk of operating errors and tampering
- Sensitivity adjustments increase the system's operational safety
- Teach-in via the single teach-in button or SOPAS operating software facilitates quick and easy operation
- Reliable gloss identification regardless of color, labeling or structure increases operational safety
- State-of-the-art detection method makes it possible to conduct inspections at lower costs than with camera solutions
- Sensor's resistance to object fluctuations increases operational safety
- Flexible sensor settings, monitoring, advanced diagnostics, and visualization thanks to IO-Link

→ [www.sick.com/de/en/Glare](http://www.sick.com/de/en/Glare)

For more information, just enter the link or scan the QR code and get direct access to technical data, CAD design models, operating instructions, software, application examples and much more.



## Detailed technical data

## Features

	Glare	Glare, IO-Link
Dimensions (W x H x D)	42.5 mm x 44 mm x 43.4 mm	
Sensor principle	Delta-S-Technology®	
Sensing distance	50 mm	
Housing design (light emission)	Rectangular	
Sensing distance tolerance	± 5 mm	
Tilt angle tolerance	± 5°	
Minimum detectable object (MDO)	12 x 14 mm	
Light source <sup>1)</sup>	LED	
Type of light	Visible red light	
Wave length	640 nm	
Light spot size	10 mm x 12 mm	
Object speed max. <sup>2)</sup>	2 m/s	
Sensitivity	Fine, middle, coarse	
Teach-in mode	1-point teach-in / 2-point teach-in / 2-point teach-in dynamic / 3-point teach-in	
IO-Link	-	✓
IO-Link functions	-	Standard functions / advanced functions (depending on type)
IO-Link advanced functions	-	Timestamp / High speed counter (depending on type)

<sup>1)</sup> Average service life: 100,000 h at T<sub>U</sub> = +25 °C.

<sup>2)</sup> Minimum object size.

## Mechanics/electronics

	Glare	Glare, IO-Link
Supply voltage <sup>1)</sup>	10 V DC ... 30 V DC	
Ripple <sup>2)</sup>	≤ 5 V <sub>pp</sub>	
Power consumption <sup>3)</sup>	< 150 mA	
Switching frequency <sup>4)</sup>	500 Hz	
Response time <sup>5)</sup>	1 ms	
Jitter	500 µs	
Input	HIGH = > V <sub>S</sub> - 2 V / LOW = open or < 2 V	
Switching output	Push/Pull (High: V <sub>S</sub> - 3 V, Low: < 3 V)	
Number of switching outputs	2 (Q1, Q2)	
Output current I <sub>max.</sub> <sup>6)</sup>	< 100 mA	
Initialization time	< 2.5 s	
On delay	-	0 s ... 30 s
Off delay	-	0 s ... 30 s
Pulse duration	-	≤ 30 s
Connection type	Connector M12, 5-pin	
Ambient light safety	> 50 klx	
Circuit protection	A <sup>7)</sup> , C <sup>8)</sup> , D <sup>9)</sup>	
Protection class	III	
Fieldbus interface	-	IO-Link
Enclosure rating	IP 67	

	Glare	Glare, IO-Link
<b>Weight</b>	130 g	
<b>Housing material</b>	Plastic, ABS	

<sup>1)</sup> Limit values; operation in short-circuit protected network max. 8 A.

<sup>2)</sup> May not exceed or fall below  $U_v$  tolerances.

<sup>3)</sup> Without load.

<sup>4)</sup> With light/dark ratio 1:1.

<sup>5)</sup> Signal transit time with resistive load.

<sup>6)</sup> Consumption count Q1 / Q2.

<sup>7)</sup> A =  $V_s$  connections reverse-polarity protected.

<sup>8)</sup> C = interference suppression.

<sup>9)</sup> D = outputs overcurrent and short-circuit protected.

## Ambient data

<b>Ambient operating temperature</b>	-10 °C ... +55 °C
<b>Ambient storage temperature</b>	-25 °C ... +75 °C
<b>Shock load</b>	According to EN 60068-2-27, single shock (30 g/11 MS), continuous shock (25 g/11 MS)
<b>UL File No.</b>	NRKH.E181493



## Ordering information

Other models → [www.sick.com/de/en/Glare](http://www.sick.com/de/en/Glare)

### Glare

IO-Link	Advanced functions	Adjustment	Connection diagram	Type	Part no.
-	-	Rotary switch (Sensitivity (Q, Q/, teach-in)) Cable (Teach-in) Single teach-in button (Teach-in)	Cd-280	OPR20G-RB111517	1065685

### Glare, IO-Link

IO-Link	Advanced functions	Adjustment	Connection diagram	Type	Part no.
Standard functions	-	Rotary switch (Sensitivity (Q, Q/, teach-in)) Cable, IO-Link (Teach-in / Keylock) <sup>1)</sup> Single teach-in button (Teach-in)	Cd-281	OPR20G-RB317537	1068822
		Rotary switch (Sensitivity (Q, Q/, teach-in)) Cable, IO-Link (Teach-in / Keylock) <sup>2)</sup> Single teach-in button (Teach-in)	Cd-281	OPR20G-RB417537	1068823
Standard functions, advanced functions	Timestamp	Rotary switch (Sensitivity (Q, Q/, teach-in)) Cable, IO-Link (Teach-in / Keylock) <sup>1)</sup> Single teach-in button (Teach-in)	Cd-281	OPR20G-RB317537A90	1072052
	High speed counter	Rotary switch (Sensitivity (Q, Q/, teach-in)) Cable, IO-Link (counter reset) Single teach-in button (Teach-in)	Cd-281	OPR20G-RB517537A01	1072051

<sup>1)</sup> Default: Teach-in.

<sup>2)</sup> Default: Keylock.



Dimensional drawing (Dimensions in mm (inch))

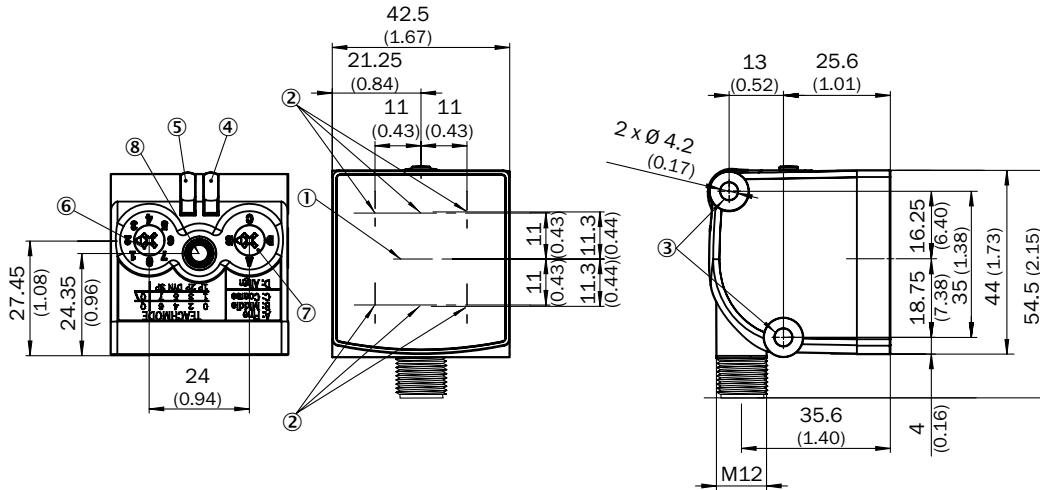

- ① Center of optical axis, sender
- ② Center of optical axis, receiver
- ③ Mounting hole
- ④ Status indicator LED green: supply voltage on
- ⑤ Status indicator LED, yellow: Detection of gloss level 1
- ⑥ Teach-in mode, inverting switching output
- ⑦ Sensitivity adjustment (A, B, C) / Operating mode (D)
- ⑧ Teach-in button

Connection diagram

Cd-280

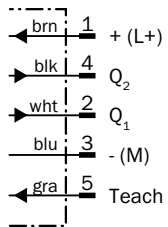

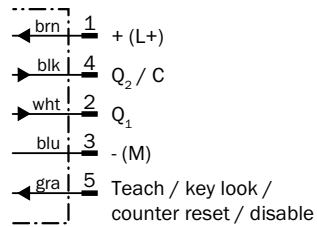

Cd-281



Recommended accessories

Modules and gateways

Connection modules

Figure	Description	Type	Part no.
	IO-Link version V1.1, Port class 2, PIN 2, 4, 5 galvanically connected, Supply voltage 18 V DC ... 32 V DC (limit values, operation in short-circuit protected network max. 8 A)	SICK Memory Stick	1064290
	IO-Link V1.1 Class A port, USB2.0 port, optional external power supply 24V / 1A	SiLink2 Master	1061790



Universal bar clamp systems

Figure	Material	Description	Type	Part no.
	Zinc diecast	Universal bar clamp for mounting bars with 12 mm diameter	BEF-KHS-KH3	5322626
	Stainless steel 1.4571 (sheet), Stainless steel 1.4408 (clamp)	Plate N10 for universal clamp bracket	BEF-KHS-N11N	2071081
	Steel, zinc coated	Mounting bar, straight, 200 mm, steel	BEF-MS12G-A	4056054
		Mounting bar, straight, 300 mm, steel	BEF-MS12G-B	4056055
	Steel, zinc coated	Mounting bar, L-shaped, 150 mm x 150 mm, steel	BEF-MS12L-A	4056052
		Mounting bar, L-shaped, 250 x 250 mm, steel	BEF-MS12L-B	4056053
	Steel, zinc coated	Mounting bar, Z-shaped, 150 mm x 70 mm x 150 mm, steel	BEF-MS12Z-A	4056056
		Mounting bar, Z-shaped, 150 mm x 70 mm x 250 mm, steel	BEF-MS12Z-B	4056057
	Aluminum	Bar clamp for bar diameter of 12 mm (fixing the mounting rod)	BEF-RMC-D12	5321878

Plug connectors and cables

Connecting cables with female connector

M12, 5-pin, PVC, chemical resistant

Figure	Connection type head A	Connection type head B	Connecting cable	Type	Part no.
	Female connector, M12, 5-pin, straight, unshielded	Cable, open conductor heads	2 m, 5-wire	DOL-1205-G02M	6008899
			5 m, 5-wire	DOL-1205-G05M	6009868
	Female connector, M12, 5-pin, angled, unshielded	Cable, open conductor heads	2 m, 5-wire	DOL-1205-W02M	6008900
			5 m, 5-wire	DOL-1205-W05M	6009869

→ For additional accessories, please see page K-240

**E**



## FORK SENSORS

F



### SICK fork sensors: more models, more functionality





Fork sensors, which operate using a through-beam design, combine the sender and receiver in a single housing. As a result, alignment is no longer time-consuming. Even very slight differences in light attenuation are detected due to highly focused light emission and high detection accuracy. Easy installation, high immunity to ambient light, and a wide range of fork widths are some of the many advantages that SICK fork

sensors offer. Applications include detecting labels or parts on conveyors.

#### Your benefits

- An integrated housing that combines the sender and receiver keeps installation time to a minimum
- A wide variety of fork widths, depths and different detection technologies (IR LED, red LED, laser and ultrasonic) meet any need
- A highly visible light spot in the laser and red light versions make these sensors easy to adjust
- High switching frequencies ensure reliable performance
- High immunity to ambient light provides reliable detection
- Aluminum housing meets requirements for use in general industrial conditions



	<b>General information</b> . . . . .	<b>F-158</b>
	<b>Product family overview</b> . . . . .	<b>F-162</b>
	<b>WFS</b> . . . . . Agile and flexible – ideal mounting for labeling applications	<b>F-164</b>
	<b>UFnext</b> . . . . . The clear choice for detecting transparent labels	<b>F-170</b>
	<b>WFnext</b> . . . . . WFnext - it's next for high-speed applications	<b>F-174</b>
	<b>WFL</b> . . . . . Get precise detection of small targets with WFL	<b>F-182</b>
	<b>WFM</b> . . . . . WFM – connect and get started	<b>F-188</b>



# RELIABLE DETECTION – QUICK AND SIMPLE ADJUSTMENT

Precision means hitting the mark without lengthy preparations. But accuracy is not the only impressive thing about SICK fork sensors. They are also excellently equipped: Their senders and receivers are contained in one housing, saving time during alignment.

Sensors that work on the through-beam principle always require a certain degree of adjustment and alignment. That is, unless the sender and receiver are contained in a stable housing made from plastic or aluminum – like SICK fork

sensors. The variants available – infrared or red light, laser or ultrasonic – therefore have a crucial advantage in the reliable detection of labels, double sheets, and different objects.

F



# TWO PRINCIPLES OF OPERATION, ONE GOAL

SICK fork sensors work on one of two principles of operation.



Optical fork sensors

Optical fork sensors detect objects via the interruption of the light beam. Even small differences in light absorption can be detected reliably.

**Fields of application**

- Label detection
- Counting and positioning objects
- Process control

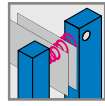

Ultrasonic fork sensors

The material properties (e.g. thickness, adhesion), rather than the translucency, are evaluated and detected reliably. Thicker materials absorb the sensor's ultrasound to a greater degree than thin materials. Transparent materials are detected regardless of printing or color.

**Fields of application**

- Label detection
- Double sheet detection
- Adhesive surface detection

## Switching function

**Switching output Q = dark-switching**

The switching output is active when the beam path is interrupted, i.e. when there is an object in the beam path.

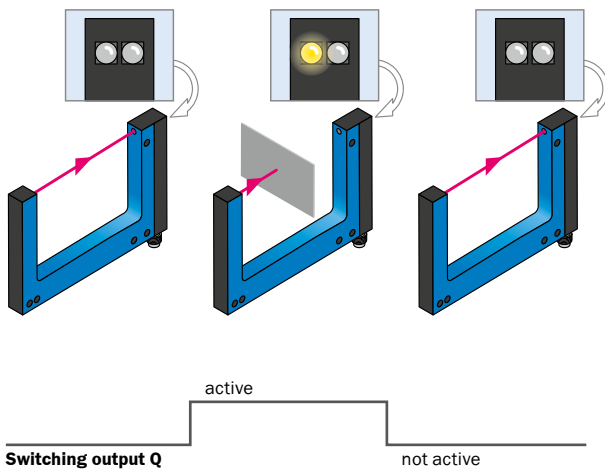

**Switching output  $\bar{Q}$  = light-switching**

The switching output is active when there is no object in the beam path.

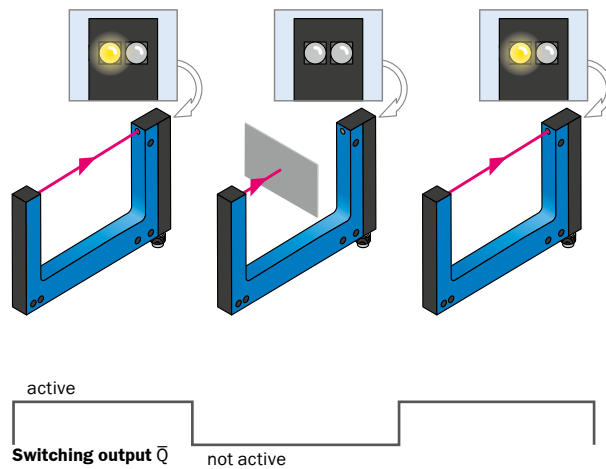

In label detection, this means that:  
The switching output is active when the label is present.

In label detection, this means that:  
The switching output is active when the label is not present.

F



## TYPICAL APPLICATIONS

### Label or double sheet detection

Transparent, shiny, metallic labels, white, opaque, and colored carrier materials, thin foils, foil on foil, paper on paper – modern labeling machines are confronted with a variety of materials and surface conditions. SICK fork sensors always offer the right solution. Optical fork sensors reliably recognize opaque labels, for example. Ultrasonic fork sensors detect even transparent materials reliably, regardless of the printing.

**WFS – Agile and flexible – ideal mounting for labeling applications**



**IO-Link**

- Infrared emission source
- Optimized housing with slim fork shape
- Dynamic teach-in via IO-Link or control panel and manual fine adjustment with plus/minus button
- Quick format change through simple configuration via IO-Link

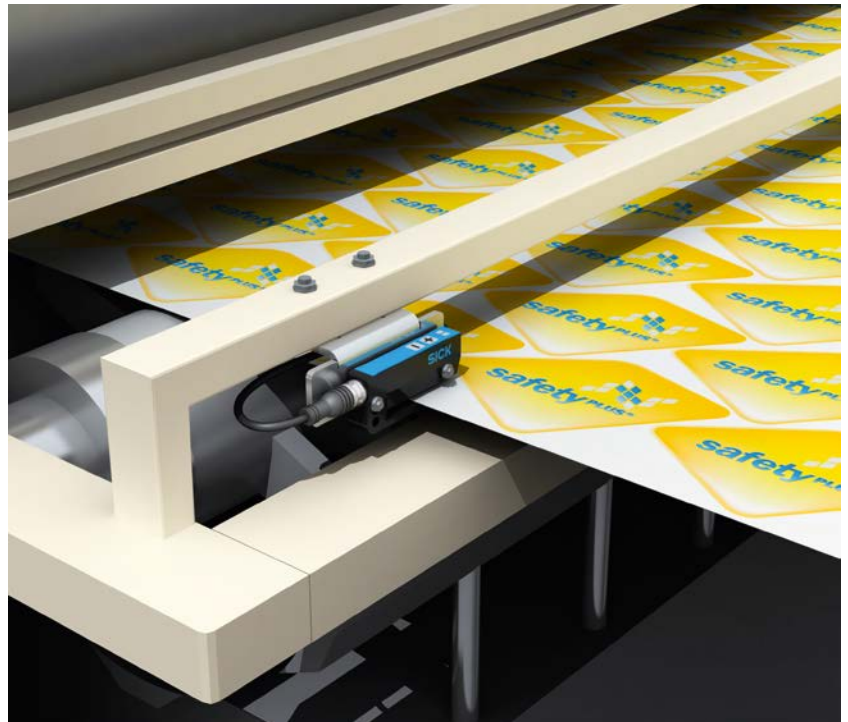

**UFnext – The clear choice for detecting transparent labels**



- Ultrasonic emission source
- Detection of transparent, opaque, or printed labels
- No interference due to metalized colors
- Response time of 250 µs



F



## Object detection

To control various processes logistically, it is necessary to reliably detect certain objects on the conveyor belts. As soon as an object passes the fork sensor, the object is detected. Thanks to different emission sources and sizes, the right fork sensor can always be found for a wide range of requirements. In accordance with the design, the sender and receiver are located in the same housing. Mounting is quick and commissioning correspondingly easy, since no complex, time-consuming alignment is needed.

### WFnext – The all-rounder for high-speed applications



- Infrared emission source
- Simple and precise setting by means of teach-in or manually with plus/minus button
- Fast response time (max. 100 µs)



### WFL – For small parts and precise positioning





- Very precise laser (Class 1)
- Simple and precise adjustment via teach-in
- Minimum detectable object size of just 0.05 mm



F

# PRODUCT FAMILY OVERVIEW

	 <p style="text-align: center;"><b>WFS</b></p>	 <p style="text-align: center;"><b>UFnext</b></p>
	<p>Agile and flexible – ideal mounting for labeling applications</p>	<p>The clear choice for detecting transparent labels</p>

Technical data overview			
<b>Functional principle</b>	Optical detection principle	Ultrasonic detection principle	
<b>Fork width</b>	3 mm	3 mm	
<b>Fork depth</b>	42 mm	69 mm	
<b>MDO</b>	Gap between labels: 2 mm Size of labels: 2 mm	Gap between labels: 2 mm Size of labels: 2 mm	
<b>Light source</b>	LED	-	
<b>Switching frequency</b>	10 kHz / 15 kHz	1.5 kHz	
<b>Response time</b>	50 µs / 35 µs	250 µs	
<b>Output function</b>	Light/darkswitching, selectable via button	Light/darkswitching, selectable via button	
<b>Connection type</b>	Connector M8, 4-pin	Connector M8, 4-pin	
<b>Fieldbus integration</b>	- / IO-Link	-	

## F

At a glance		
	<ul style="list-style-type: none"> <li>• Optimized housing with slim fork shape</li> <li>• Dynamic teach-in IO Link or control panel and manual fine adjustment with “+”/“-” buttons</li> <li>• Light/dark switching function</li> <li>• Fast response time of 35 µs</li> <li>• PNP or NPN</li> <li>• IP 65 plastic housing</li> <li>• Switching output also during teach-in active</li> <li>• IO-Link version 1.1</li> </ul>	<ul style="list-style-type: none"> <li>• Detection of transparent, opaque or printed labels</li> <li>• Unaffected by metallic foils and labels</li> <li>• Fast response time of 250 µs</li> <li>• Simple and accurate adjustment via “+”/“-”-buttons or teach-in</li> <li>• Rugged, IP 65 aluminum housing</li> </ul>

<p>Detailed information</p>	<p>→ F-164</p>	<p>→ F-170</p>
-----------------------------	----------------	----------------



**WFnext**

WFnext - it's next for high-speed applications



**WFL**

Get precise detection of small targets with WFL



**WFM**

WFM – connect and get started

	Optical detection principle	Optical detection principle	Optical detection principle
	2 mm ... 120 mm	2 mm ... 120 mm	30 mm ... 180 mm
	42 mm ... 95 mm	42 mm ... 95 mm	42 mm ... 124 mm
	0.2 mm	0.05 mm	0.8 mm
	LED	Laser	LED
	10 kHz	10 kHz	4 kHz
	100 µs	100 µs	125 µs
	Light/darkswitching, selectable via button	Light/darkswitching, selectable via button	Dark switching / Light switching
	Connector M8, 4-pin	Connector M8, 4-pin	Connector M8, 3-pin Cable, 3-wire 2 m
	-	-	-

- Infrared light source
- Simple and accurate adjustment via teach-in or manually via “+”/”-” buttons
- Fast response time (max. 100 µs)
- PNP and NPN switching output
- Light/dark switching function
- 21 different models with different fork widths and depths
- Rugged, IP 65 aluminum housing

→ F-174

- Very precise laser beam (Class 1 laser)
- Simple and accurate adjustment via teach-in
- Fast response time (max. 100 µs)
- Minimum detectable object size of 0.05 mm
- PNP and NPN switching output
- Light/dark switching function
- 21 different models with different fork widths and depths
- Rugged, IP 65 aluminum housing

→ F-182

- Highly visible red emitted light
- No setup, out-of-the-box operation
- 360° output indicator
- 5 fork sizes: maximum depth 120 mm, maximum width 180 mm
- Rugged, IP 67 aluminum housing

→ F-188



# AGILE AND FLEXIBLE – IDEAL MOUNTING FOR LABELING APPLICATIONS



## Product description

The slim, forked shape of the WFS has been specially developed for the requirements of the labeling process. The design allows the sensor to be mounted directly on the edge of the dispenser. Difficulty in detecting the label gap is finally eliminated – the sensor's switch-

ing threshold can be taught-in while the label strip is running. The improved operating concept means the sensor can be adjusted to different labels quickly, easily and reliably. The fast response time guarantees exceptional repeat accuracy.

## At a glance

- Optimized housing with slim fork shape
- Dynamic teach-in IO Link or control panel and manual fine adjustment with “+”/“-” buttons
- Light/dark switching function
- Fast response time of 35 µs
- PNP or NPN
- IP 65 plastic housing
- Switching output also during teach-in active
- IO-Link version 1.1

## Your benefits

- Slim design allows flexible mounting close to the dispenser of the label which ensures higher accuracy in the process
- Compact housing ensures space-saving installation
- User friendly adjustment allows easy and quick start-up
- IO Link or external teach-in allows automatic threshold adjustment via the PLC during the process which ensures reliable detection all the time
- Short and fast response times enables precise detection – even at high web speeds
- IO-Link provides easy data access from the PLC
- Quick and easy integration using function blocks
- Flexible sensor settings, monitoring, advanced diagnostics, and visualization thanks to IO-Link

 **IO-Link**



## Additional information

- Detailed technical data . . . . . F-165
- Ordering information . . . . . F-166
- Dimensional drawing . . . . . F-166
- Adjustments . . . . . F-166
- Connection diagram . . . . . F-167
- Setting the switching threshold . F-167
- Recommended accessories . . . . F-168

→ [www.sick.com/de/en/WFS](http://www.sick.com/de/en/WFS)

For more information, just enter the link or scan the QR code and get direct access to technical data, CAD design models, operating instructions, software, application examples and much more.



F

## Detailed technical data

### Features

	WFS	WFS IO-Link
Dimensions (W x H x D)	10 mm x 25 mm x 64.3 mm	
Functional principle	Optical detection principle	
Housing design (light emission)	Fork shaped	
Fork width	3 mm	
Fork depth	42 mm	
Minimum detectable object (MDO)	Gap between labels: 2 mm / Size of labels: 2 mm <sup>1)</sup>	
Label detection	✓	
Light source	LED	
Type of light	Infrared light	
Adjustment	Dynamic teach-in, Static teach-in, Manual ("+"/"-" button)	Dynamic teach-in, Static teach-in, Manual ("+"/"-" button), IO-Link
Output function	Light/darkswitching, selectable via button	

<sup>1)</sup> Depends on the label thickness.

### Mechanics/electronics

	WFS	WFS IO-Link
Supply voltage <sup>1)</sup>	10 V DC ... 30 V DC	
Ripple <sup>2)</sup>	< 10 %	
Power consumption <sup>3)</sup>	20 mA	
Switching frequency	10 kHz <sup>4)</sup>	15 kHz <sup>5)</sup>
Response time <sup>6)</sup>	50 µs	35 µs
Stability of response time	± 20 µs	
Jitter	-	15 µs
Switching output	PNP: HIGH = $V_S - \leq 2 \text{ V}$ / LOW approx. 0 V NPN: HIGH = approx. $V_S$ / LOW $\leq 2 \text{ V}$	
Output type	PNP / NPN (depending on type)	
Output current $I_{\text{max}}$	100 mA	
Input, teach-in (ET)	PNP Teach: $U > 5 \text{ V} \dots < U_V$ Run: $U < 4 \text{ V}$ NPN Teach: $U < (U_V - 6 \text{ V})$ Run: $U > (U_V - 5 \text{ V})$	
Initialization time	20 ms	40 ms
Connection type	Connector M8, 4-pin	
Ambient light safety	$\leq 10,000 \text{ lx}$	
Protection class	III	
Circuit protection	$V_S$ connections reverse-polarity protected, Output Q short-circuit protected, Interference suppression	
Fieldbus interface	-	IO-Link
Enclosure rating	IP 65	
Weight	Approx. 36 g	
Housing material	Plastic, PA (glass-fiber reinforced)	

<sup>1)</sup> Limit values, reverse-polarity protected, operation in short-circuit protected network: max. 8 A.

<sup>2)</sup> May not exceed or fall below  $U_V$  tolerances.

<sup>3)</sup> Without load.

<sup>4)</sup> With light/dark ratio 1:1.

<sup>5)</sup> With light/dark ratio 1:1, typical, during teach-in 6 kHz.

<sup>6)</sup> Signal transit time with resistive load.



## Connection diagram

Cd-092

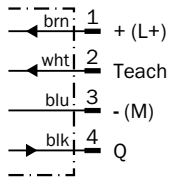

Cd-278

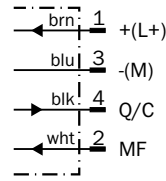

## Setting the switching threshold

1. Position label or substrate in the active area of the fork sensor
2. Move multiple labels through the fork sensor

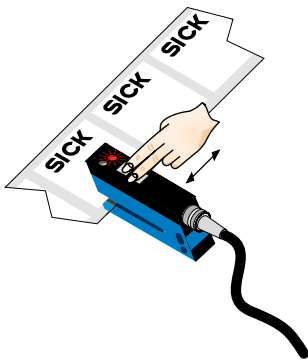

Press both the "+" and "-" buttons together, hold > 1 s and then release the teach-in buttons. The red LED flashes.

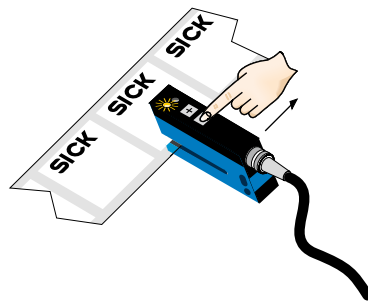

Press "-" button, teach-in process is finished.

### Notes

Switching threshold adaptation:

Only, the first teach-in procedure after switching on is permanently stored. Teach-in can be repeated cyclically. Switching output also during teach-in active.

- + Once teach-in process is complete, the switching threshold can be adjusted at any time using the "+" or "-" button. To make minor adjustments, press the "+" or "-" button once. To configure settings quickly, keep the "+" or "-" button pressed for longer.
- 

$\pm \frac{0}{3s}$  Press both the "+" and "-" buttons together (3 seconds) to lock the device and prevent unintentional actuation.

$\pm \frac{L/D}{6s}$  Press both the "+" and "-" buttons together (6 seconds) to define the switching function (light/dark switching). Standard setting: Q = light switching.

Teach-in (static): Setting the switching threshold without movements of label, cf. operating instruction.



Recommended accessories

Universal bar clamp systems

Material	Description	Type	Part no.
Steel, zinc coated	Mounting bar, straight	BEF-M12GF-A	2059414

Modules and gateways



Connection modules

Figure	Description	Type	Part no.
	IO-Link version V1.1, Port class 2, PIN 2, 4, 5 galvanically connected, Supply voltage 18 V DC ... 32 V DC (limit values, operation in short-circuit protected network max. 8 A)	SICK Memory Stick	1064290
	IO-Link V1.1 Class A port, USB2.0 port, optional external power supply 24V / 1A	SiLink2 Master	1061790

Plug connectors and cables

Connecting cables with female connector

M8, 4-pin, PVC, chemical resistant

Figure	Connection type head A	Connection type head B	Connecting cable	Type	Part no.
	Female connector, M8, 4-pin, straight, unshielded	Cable, open conductor heads	2 m, 4-wire	DOL-0804-G02M	6009870
			5 m, 4-wire	DOL-0804-G05M	6009872
			10 m, 4-wire	DOL-0804-G10M	6010754
	Female connector, M8, 4-pin, angled, unshielded	Cable, open conductor heads	2 m, 4-wire	DOL-0804-W02M	6009871
			5 m, 4-wire	DOL-0804-W05M	6009873
			10 m, 4-wire	DOL-0804-W10M	6010755

→ For additional accessories, please see page K-240

F



**F**

# THE CLEAR CHOICE FOR DETECTING TRANSPARENT LABELS



F

## Product description

The UF ultrasonic sensors reliably detects labels and materials, regardless of printed design, transparency or surface characteristics. Unlike optical sensors, the UF3 relies on damping – a process where the thickness of a material determines the degree to which the sensor absorbs sound waves. A high level of positioning accuracy and stable response times make the fork sensor suitable for nearly any environment. Due

to its small, compact metal housing, the UF can be used in harsh conditions and where space is limited. As a result, the UF3 can distinguish between labels located just 2 mm apart from one another on an adhesive tape. Applications include detecting transparent labels on transparent substrates, detecting labels with different printed designs or differentiating between single- and two-ply materials.

## At a glance

- Detection of transparent, opaque or printed labels
- Unaffected by metallic foils and labels
- Fast response time of 250 µs
- Simple and accurate adjustment via “+”/“-”-buttons or teach-in
- Rugged, IP 65 aluminum housing

## Your benefits

- Reliable label detection, regardless if labels are transparent, opaque or have a printed design, ensuring greater flexibility with one sensor
- Fast response times enable precise detection – even at high web speeds
- The aluminum housing meets all requirements for use in harsh industrial conditions
- Setting the switching threshold using the +/- push buttons or teach-in
- Ultrasonic technology prevents false detection, which may be caused by ambient light or shiny surfaces



## Additional information

Detailed technical data . . . . . F-171  
 Ordering information . . . . . F-172  
 Dimensional drawing . . . . . F-172  
 Adjustments . . . . . F-172  
 Connection diagram . . . . . F-172  
 Setting the switching threshold . F-173  
 Recommended accessories . . . . F-173

→ [www.sick.com/de/en/UF](http://www.sick.com/de/en/UF)

For more information, just enter the link or scan the QR code and get direct access to technical data, CAD design models, operating instructions, software, application examples and much more.



## Detailed technical data

### Features

<b>Dimensions (W x H x D)</b>	18 mm x 47.5 mm x 92.5 mm
<b>Functional principle</b>	Ultrasonic detection principle
<b>Housing design (light emission)</b>	Fork shaped
<b>Fork width</b>	3 mm
<b>Fork depth</b>	69 mm
<b>Minimum detectable object (MDO)</b>	Gap between labels: 2 mm Size of labels: 2 mm
<b>Label detection</b>	✓
<b>Adjustment</b>	Dynamic teach-in, Static teach-in
<b>Output function</b>	Light/darkswitching, selectable via button

### Mechanics/electronics

<b>Supply voltage</b> <sup>1)</sup>	10 V DC ... 30 V DC
<b>Ripple</b> <sup>2)</sup>	< 10 %
<b>Power consumption</b> <sup>3)</sup>	40 mA
<b>Switching frequency</b> <sup>4)</sup>	1.5 kHz
<b>Response time</b> <sup>5)</sup>	250 µs
<b>Switching output</b>	PNP: HIGH = $V_S - \leq 2 \text{ V}$ / LOW approx. 0 V NPN: HIGH = approx. $V_S$ / LOW $\leq 2 \text{ V}$ (depending on type)
<b>Output type</b>	PNP / NPN (depending on type)
<b>Output current <math>I_{\text{max}}</math></b> <sup>6)</sup>	100 mA
<b>Input, teach-in (ET)</b>	Teach: $U > 7 \text{ V} \dots < U_V$ ; Run: $U < 2 \text{ V}$
<b>Initialization time</b>	100 ms
<b>Connection type</b>	Connector M8, 4-pin
<b>Protection class</b> <sup>7)</sup>	III
<b>Circuit protection</b>	Output Q short-circuit protected, Interference suppression
<b>Enclosure rating</b>	IP 65
<b>Weight</b>	95 g
<b>Housing material</b>	Metal, aluminum

<sup>1)</sup> Limit values, reverse-polarity protected, operation in short-circuit protected network: max. 8 A.

<sup>2)</sup> May not exceed or fall below  $U_V$  tolerances.

<sup>3)</sup> Without load.

<sup>4)</sup> With light/dark ratio 1:1, typical, dependent on material and speed.

<sup>5)</sup> Signal transit time with resistive load.

<sup>6)</sup> Output current minimal 0.03 mA.

<sup>7)</sup> Reference voltage DC 50 V.

### Ambient data

<b>Ambient operating temperature</b> <sup>1)</sup>	+5 °C ... +55 °C
<b>Ambient storage temperature</b>	-20 °C ... +70 °C
<b>Shock load</b>	According to EN 60068-2-27
<b>EMC</b> <sup>2)</sup>	EN 60947-5-2

<sup>1)</sup> Do not bend below 0 °C.

<sup>2)</sup> The UFN complies with the Radio Safety Requirements (EMC) for the industrial sector (Radio Safety Class A). It may cause radio interference if used in residential areas.

Ordering information

Other models → [www.sick.com/de/en/UF](http://www.sick.com/de/en/UF)

- **Connection type:** Connector M8, 4-pin

Fork width	Fork depth	Teach-in	Output type	Connection diagram	Type	Part no.
3 mm	69 mm	-	PNP/NPN	Cd-086	UFN3-70B413	6049678
		Teach: $U > 7 V \dots < U_V$ Run: $U < 2 V$	NPN	Cd-092	UFN3-70N415	6049680
			PNP	Cd-092	UFN3-70P415	6049679

Dimensional drawing (Dimensions in mm (inch))

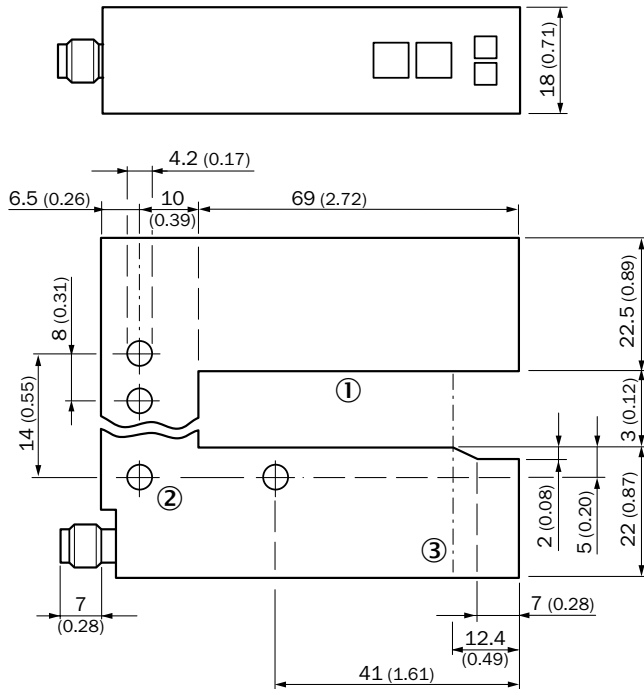

Adjustments

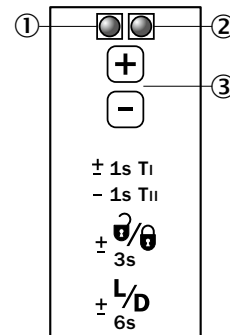

- ① Function signal indicator (yellow), switching output
- ② Function indicator (red)
- ③ “+”/“-” buttons and function button

- ① Fork opening: fork width 3 mm, forks depth 69 mm
- ② Mounting hole,  $\varnothing$  4.2 mm
- ③ Detection axis

Connection diagram

Cd-086

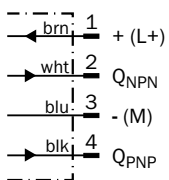

Cd-092

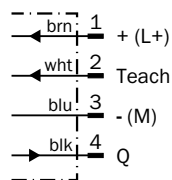

## Setting the switching threshold

Teach-in dynamic

### 1. Position label or substrate in the active area of the fork sensor

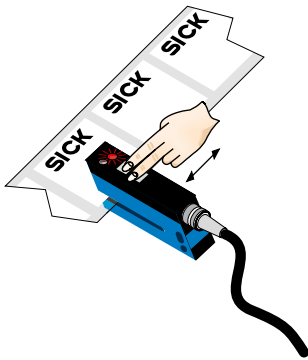

Press both the “+” and “-” buttons together, hold > 1 s and then release the teach-in buttons. The red LED flashes.

### 2. Move multiple labels through the fork sensor

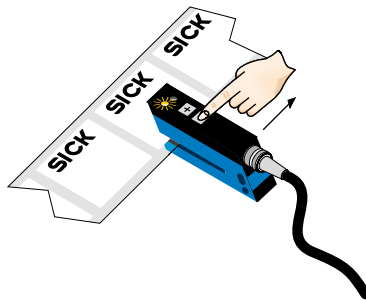

Press “-” button, teach-in process is finished.

### Notes

Switching threshold adaptation:  
Only, the first teach-in procedure after switching on is permanently stored. Teach-in can be repeated cyclically. Switching output also during teach-in active.

- + Once teach-in process is complete, the switching threshold can be adjusted at any time using the “+” or “-” button. To make minor adjustments, press the “+” or “-” button once. To configure settings quickly, keep the “+” or “-” button pressed for longer.
- 
- $\pm \frac{0}{3s}$  Press both the “+” and “-” buttons together (3 seconds) to lock the device and prevent unintentional actuation.
- $\pm \frac{L/D}{6s}$  Press both the “+” and “-” buttons together (6 seconds) to define the switching function (light/dark switching). Standard setting: Q = light switching.

Teach-in (static): Setting the switching threshold without movements of label, cf. operating instruction.

## Recommended accessories

### Plug connectors and cables

Connecting cables with female connector

M8, 4-pin, PVC, chemical resistant

Figure	Connection type head A	Connection type head B	Connecting cable	Type	Part no.
	Female connector, M8, 4-pin, straight, unshielded	Cable, open conductor heads	2 m, 4-wire	DOL-0804-G02M	6009870
			5 m, 4-wire	DOL-0804-G05M	6009872
			10 m, 4-wire	DOL-0804-G10M	6010754
	Female connector, M8, 4-pin, angled, unshielded	Cable, open conductor heads	2 m, 4-wire	DOL-0804-W02M	6009871
			5 m, 4-wire	DOL-0804-W05M	6009873
			10 m, 4-wire	DOL-0804-W10M	6010755

→ For additional accessories, please see page K-240

# WFNEXT – IT'S NEXT FOR HIGH-SPEED APPLICATIONS



F



### Additional information

Detailed technical data . . . . . F-175  
 Ordering information . . . . . F-176  
 Dimensional drawing . . . . . F-178  
 Adjustments . . . . . F-178  
 Connection diagram . . . . . F-178  
 Setting the switching threshold . F-179  
 Recommended accessories . . . . F-180

### Product description

The WFnext line is ideal for high-speed, accurate label detection. It includes more than 40 fork sensors with a large selection of fork widths and depths to fit any application, such as detecting labels, holes or double sheets. Since the sender and receiver are in one housing, adjustment is not necessary. This easy-to-use sensor line includes fork widths

between 2 mm and 120 mm with fork depths of 40 mm, 60 mm and 95 mm. Its fast response time and fine resolution make it possible to detect small and flat objects moving at high speeds. On multiple installations, WFnext sensors can be installed adjacent to one another with no cross talk.

### At a glance

- Infrared light source
- Simple and accurate adjustment via teach-in or manually via “+”/”-” buttons
- Fast response time (max. 100 µs)
- PNP and NPN switching output
- Light/dark switching function
- 21 different models with different fork widths and depths
- Rugged, IP 65 aluminum housing

### Your benefits

- Fast response time and fine resolution ensure reliable detection even at high speeds
- Infrared light source provides excellent ambient light immunity
- User friendly setting via teach-in or “+”/”-” button
- A wide range of different fork sizes enables flexible installation
- The aluminum housing meets all requirements for use in harsh industrial conditions

→ [www.sick.com/de/en/WF](http://www.sick.com/de/en/WF)

For more information, just enter the link or scan the QR code and get direct access to technical data, CAD design models, operating instructions, software, application examples and much more.



## Detailed technical data

### Features

<b>Functional principle</b>	Optical detection principle
<b>Housing design (light emission)</b>	Fork shaped
<b>Fork width</b>	2 mm ... 120 mm (depending on type)
<b>Fork depth</b>	42 mm ... 95 mm (depending on type)
<b>Minimum detectable object (MDO)</b>	0.2 mm
<b>Label detection</b>	✓ / - (depending on type)
<b>Light source</b>	LED
<b>Type of light</b>	Infrared light
<b>Adjustment</b>	Manual (“+”/“-” button) / Teach-in (depending on type)
<b>Output function</b>	Light/darkswitching, selectable via button

### Mechanics/electronics

<b>Supply voltage</b> <sup>1)</sup>	10 V DC ... 30 V DC
<b>Ripple</b> <sup>2)</sup>	< 10 %
<b>Power consumption</b> <sup>3)</sup>	40 mA
<b>Switching frequency</b> <sup>4)</sup>	10 kHz
<b>Response time</b> <sup>5)</sup>	100 µs
<b>Stability of response time</b>	± 20 µs
<b>Switching output</b>	PNP: HIGH = $V_S - \leq 2 \text{ V}$ / LOW approx. 0 V NPN: HIGH = approx. $V_S$ / LOW $\leq 2 \text{ V}$
<b>Output type</b>	PNP/NPN
<b>Output current <math>I_{\text{max}}</math></b>	100 mA
<b>Initialization time</b>	100 ms
<b>Connection type</b>	Connector M8, 4-pin
<b>Ambient light safety</b>	Sunlight: $\leq 10,000 \text{ klx}$
<b>Protection class</b> <sup>6)</sup>	III
<b>Circuit protection</b>	$V_S$ connections reverse-polarity protected, Output Q short-circuit protected, Interference suppression
<b>Enclosure rating</b>	IP 65
<b>Weight</b> <sup>7)</sup>	Approx. 36 g ... 160 g
<b>Housing material</b>	Metal, aluminum

<sup>1)</sup> Limit values, reverse-polarity protected, operation in short-circuit protected network: max. 8 A.

<sup>2)</sup> May not exceed or fall below  $U_v$  tolerances.

<sup>3)</sup> Without load.

<sup>4)</sup> With light/dark ratio 1:1.

<sup>5)</sup> Signal transit time with resistive load.

<sup>6)</sup> Reference voltage DC 50 V.

<sup>7)</sup> Depending on fork width.

### Ambient data

<b>Ambient operating temperature</b> <sup>1)</sup>	-20 °C ... +60 °C
<b>Ambient storage temperature</b>	-30 °C ... +80 °C
<b>Shock load</b>	According to EN 60068-2-27
<b>UL File No.</b>	NRKH.E191603

<sup>1)</sup> Do not bend below 0 °C.

## Ordering information

Other models → [www.sick.com/de/en/WF](http://www.sick.com/de/en/WF)

### WF2

- **Fork width:** 2 mm

MDO <sup>1)</sup>	Switching output	Adjustment	Fork depth	Type	Part no.
0.2 mm	PNP/NPN	Manual (“+”/“-” button)	42 mm	WF2-40B410	6028428
			59 mm	WF2-60B410	6028436
			95 mm	WF2-95B410	6028443
		Teach-in	42 mm	WF2-40B416	6028450
			59 mm	WF2-60B416	6028457
			95 mm	WF2-95B416	6028464

<sup>1)</sup> Minimum detectable object.

### WF5

- **Fork width:** 5 mm

MDO <sup>1)</sup>	Switching output	Adjustment	Fork depth	Type	Part no.
0.2 mm	PNP/NPN	Manual (“+”/“-” button)	42 mm	WF5-40B410	6028429
			59 mm	WF5-60B410	6028437
			95 mm	WF5-95B410	6028444
		Teach-in	42 mm	WF5-40B416	6028451
			59 mm	WF5-60B416	6028458
			95 mm	WF5-95B416	6028465

<sup>1)</sup> Minimum detectable object.

### WF15

- **Fork width:** 15 mm

MDO <sup>1)</sup>	Switching output	Adjustment	Fork depth	Type	Part no.
0.2 mm	PNP/NPN	Manual (“+”/“-” button)	42 mm	WF15-40B410	6028430
			59 mm	WF15-60B410	6028438
			95 mm	WF15-95B410	6028445
		Teach-in	42 mm	WF15-40B416	6028452
			59 mm	WF15-60B416	6028459
			95 mm	WF15-95B416	6028466

<sup>1)</sup> Minimum detectable object.

### WF30

- **Fork width:** 30 mm

MDO <sup>1)</sup>	Switching output	Adjustment	Fork depth	Type	Part no.
0.2 mm	PNP/NPN	Manual (“+”/“-” button)	42 mm	WF30-40B410	6028431
			59 mm	WF30-60B410	6028439
			95 mm	WF30-95B410	6028446
		Teach-in	42 mm	WF30-40B416	6028453
			59 mm	WF30-60B416	6028460
			95 mm	WF30-95B416	6028467

<sup>1)</sup> Minimum detectable object.

F



## WF50

- **Fork width:** 50 mm

MDO <sup>1)</sup>	Switching output	Adjustment	Fork depth	Type	Part no.
0.2 mm	PNP/NPN	Manual (“+”/“-” button)	42 mm	WF50-40B410	6028432
			59 mm	WF50-60B410	6028440
			95 mm	WF50-95B410	6028447
		Teach-in	42 mm	WF50-40B416	6028454
			59 mm	WF50-60B416	6028461
			95 mm	WF50-95B416	6028468

<sup>1)</sup> Minimum detectable object.

## WF80

- **Fork width:** 80 mm

MDO <sup>1)</sup>	Switching output	Adjustment	Fork depth	Type	Part no.
0.2 mm	PNP/NPN	Manual (“+”/“-” button)	42 mm	WF80-40B410	6028433
			59 mm	WF80-60B410	6028441
			95 mm	WF80-95B410	6028448
		Teach-in	42 mm	WF80-40B416	6028455
			59 mm	WF80-60B416	6028462
			95 mm	WF80-95B416	6028469

<sup>1)</sup> Minimum detectable object.

## WF120

- **Fork width:** 120 mm

MDO <sup>1)</sup>	Switching output	Adjustment	Fork depth	Type	Part no.
0.2 mm	PNP/NPN	Manual (“+”/“-” button)	42 mm	WF120-40B410	6028435
			59 mm	WF120-60B410	6028442
			95 mm	WF120-95B410	6028449
		Teach-in	42 mm	WF120-40B416	6028456
			59 mm	WF120-60B416	6028463
			95 mm	WF120-95B416	6028470

<sup>1)</sup> Minimum detectable object.



Dimensional drawing (Dimensions in mm (inch))

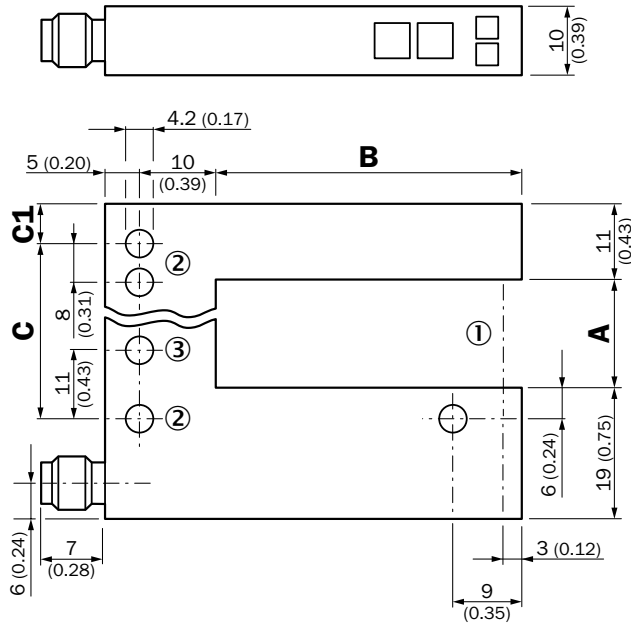

Dimensions in mm (inch)

	A Fork width	B Fork depth	C	C1
WF2	2 (0.08)	42/59/95 (1.65/2.32/3.74)	14 (0.55)	5 (0.20)
WF5	5 (0.20)	42/59/95 (1.65/2.32/3.74)	14 (0.55)	6.5 (0.20)
WF15	15 (0.59)	42/59/95 (1.65/2.32/3.74)	27 (1.06)	5 (0.20)
WF30	30 (1.18)	42/59/95 (1.65/2.32/3.74)	42 (1.65)	5 (0.20)
WF50	50 (1.97)	42/59/95 (1.65/2.32/3.74)	51 (2.01)	16 (0.63)
WF80	80 (3.15)	42/59/95 (1.65/2.32/3.74)	81 (3.19)	16 (0.63)
WF120	120 (4.72)	42/59/95 (1.65/2.32/3.74)	121 (4.76)	16 (0.63)

- ① Optical axis
- ② Mounting hole, Ø 4.2 mm
- ③ WF50/80/120 only

Adjustments

Manual

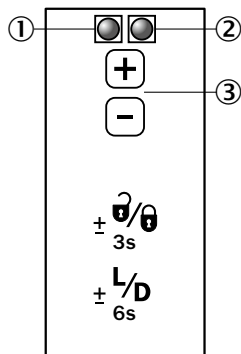

- ① Function signal indicator (yellow), switching output
- ② Function indicator (red)
- ③ “+”/“-” buttons and function button

Teach-in

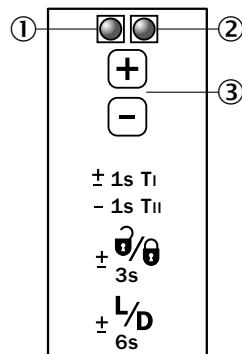

- ① Function signal indicator (yellow), switching output
- ② Function indicator (red)
- ③ “+”/“-” buttons and function button

Connection diagram

Cd-086

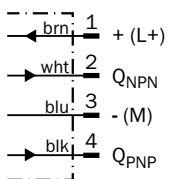

## Setting the switching threshold

+/- button

### 1. No object in the beam path

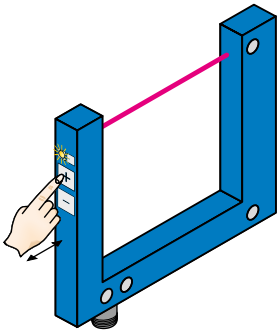

The yellow function indicator illuminates when the light received is at its optimum level. If necessary, increase sensitivity using the "+" button.

### 2. Object in the beam path

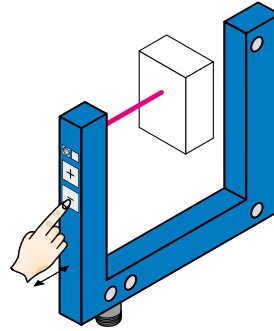

Yellow function indicator goes out. If necessary, reduce sensitivity using the "-" button.

Teach-in

**The switching threshold is set automatically. Fine adjustment is possible using the "+"/"-" buttons.**

### 1. No object or substrate in the beam path

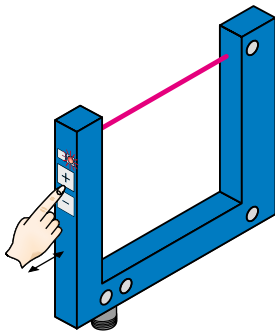

Press the "+" and "-" buttons together and hold for 1 second. The red function indicator flashes slowly.

### 2. Object or label in the beam path

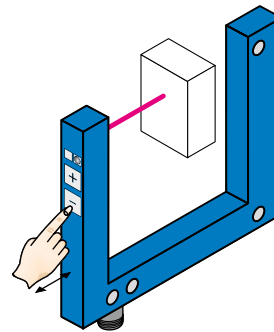

Press the "-" button for 1 second. Red function indicator goes out.

## Notes

Material speed = 0 (machine at a standstill).

- + Once teach-in process is complete, the switching threshold can be adjusted at any time using the "+" or "-" button. To make minor adjustments, press the "+" or "-" button once.
- To configure settings quickly, keep the "+" or "-" button pressed for longer.

$\pm \frac{0}{3s}$  Press both the "+" and "-" buttons together (3 seconds) to lock the device and prevent unintentional actuation.



$\pm \frac{L/D}{6s}$  Press both the "+" and "-" buttons together (6 seconds) to define the switching function (light/dark switching). Standard setting:  $\bar{Q}$  = light switching.

Recommended accessories

Plug connectors and cables

Connecting cables with female connector

M8, 4-pin, PVC, chemical resistant

Figure	Connection type head A	Connection type head B	Connecting cable	Type	Part no.
	Female connector, M8, 4-pin, straight, unshielded	Cable, open conductor heads	2 m, 4-wire	DOL-0804-G02M	6009870
			5 m, 4-wire	DOL-0804-G05M	6009872
			10 m, 4-wire	DOL-0804-G10M	6010754
	Female connector, M8, 4-pin, angled, unshielded	Cable, open conductor heads	2 m, 4-wire	DOL-0804-W02M	6009871
			5 m, 4-wire	DOL-0804-W05M	6009873
			10 m, 4-wire	DOL-0804-W10M	6010755

→ For additional accessories, please see page K-240

F

**F**

# GET PRECISE DETECTION OF SMALL TARGETS WITH WFL



F

## Product description

The WFL laser fork sensor family is characterized by fast response times and a highly focused visible laser beam. The sender and receiver, which operate using the through-beam principle, are combined in a single housing. This enables maximum positioning accuracy. Due to

extremely fast response times and high resolutions, these sensors are ideal for detecting very small objects, such as needles, and transparent objects. With more than 20 sensors available, this line of fork sensors can be used for a wide variety of applications.

## At a glance

- Very precise laser beam (Class 1 laser)
- Simple and accurate adjustment via teach-in
- Fast response time (max. 100 µs)
- Minimum detectable object size of 0.05 mm
- PNP and NPN switching output
- Light/dark switching function
- 21 different models with different fork widths and depths
- Rugged, IP 65 aluminum housing

## Your benefits

- A highly precise laser beam ensures consistent measurement accuracy along the entire measuring range and reliable detection of the smallest objects
- A visible laser light spot enables easy alignment and fast adjustment
- Reliable and simple setting via teach-in ensures high process reliability
- A wide range of different fork sizes increases installation flexibility
- The aluminum housing meets all requirements for use in harsh industrial conditions



## Additional information

Detailed technical data . . . . . F-183  
 Ordering information . . . . . F-184  
 Dimensional drawing . . . . . F-185  
 Adjustments . . . . . F-186  
 Connection diagram . . . . . F-186  
 Setting the switching threshold . F-186  
 Recommended accessories . . . . F-187

→ [www.sick.com/de/en/WFL](http://www.sick.com/de/en/WFL)

For more information, just enter the link or scan the QR code and get direct access to technical data, CAD design models, operating instructions, software, application examples and much more.



## Detailed technical data

### Features

<b>Functional principle</b>	Optical detection principle
<b>Housing design (light emission)</b>	Fork shaped
<b>Fork width</b>	2 mm ... 120 mm (depending on type)
<b>Fork depth</b>	42 mm ... 95 mm (depending on type)
<b>Minimum detectable object (MDO)</b>	0.05 mm
<b>Light source</b>	Laser
<b>Type of light</b>	Visible red light
<b>Wave length</b>	670 nm
<b>Laser class</b>	I
<b>Adjustment</b>	Teach-in
<b>Output function</b>	Light/darkswitching, selectable via button

### Mechanics/electronics

<b>Supply voltage</b> <sup>1)</sup>	10 V DC ... 30 V DC
<b>Ripple</b> <sup>2)</sup>	< 10 %
<b>Power consumption</b> <sup>3)</sup>	40 mA
<b>Switching frequency</b> <sup>4)</sup>	10 kHz
<b>Response time</b> <sup>5)</sup>	100 µs
<b>Stability of response time</b>	± 20 µs
<b>Switching output</b>	PNP: HIGH = $V_S - \leq 2 \text{ V}$ / LOW approx. 0 V NPN: HIGH = approx. $V_S$ / LOW $\leq 2 \text{ V}$
<b>Output type</b>	PNP/NPN
<b>Output current <math>I_{\text{max}}</math></b>	100 mA
<b>Initialization time</b>	100 ms
<b>Connection type</b>	Connector M8, 4-pin
<b>Ambient light safety</b>	Sunlight: $\leq 10,000 \text{ klx}$
<b>Protection class</b> <sup>6)</sup>	III
<b>Circuit protection</b>	$V_S$ connections reverse-polarity protected, Output Q short-circuit protected, Interference suppression
<b>Enclosure rating</b>	IP 65
<b>Weight</b> <sup>7)</sup>	Approx. 36 g ... 160 g
<b>Housing material</b>	Metal, aluminum

<sup>1)</sup> Limit values, reverse-polarity protected, operation in short-circuit protected network: max. 8 A.

<sup>2)</sup> May not exceed or fall below  $U_v$  tolerances.

<sup>3)</sup> Without load.

<sup>4)</sup> With light/dark ratio 1:1.

<sup>5)</sup> Signal transit time with resistive load.

<sup>6)</sup> Reference voltage DC 50 V.

<sup>7)</sup> Depending on fork width.

### Ambient data

<b>Ambient operating temperature</b> <sup>1)</sup>	-20 °C ... +50 °C
<b>Ambient storage temperature</b>	-30 °C ... +80 °C
<b>Shock load</b>	According to EN 60068-2-27
<b>UL File No.</b>	NRKH.E191603 & NRKH7.E191603, CDRH-conform

<sup>1)</sup> Do not bend below 0 °C.

Ordering information

Other models → [www.sick.com/de/en/WFL](http://www.sick.com/de/en/WFL)

Teach-in

WFL2

- **Fork width:** 2 mm

MDO	Switching output	Adjustment	Fork depth	Type	Part no.
0.05 mm	PNP/NPN	Teach-in	42 mm	WFL2-40B416	6036821
			59 mm	WFL2-60B416	6036828
			95 mm	WFL2-95B416	6036835

WFL5

- **Fork width:** 5 mm

MDO	Switching output	Adjustment	Fork depth	Type	Part no.
0.05 mm	PNP/NPN	Teach-in	42 mm	WFL5-40B416	6036822
			59 mm	WFL5-60B416	6036829
			95 mm	WFL5-95B416	6036836

WFL15

- **Fork width:** 15 mm

MDO	Switching output	Adjustment	Fork depth	Type	Part no.
0.05 mm	PNP/NPN	Teach-in	42 mm	WFL15-40B416	6036823
			59 mm	WFL15-60B416	6036830
			95 mm	WFL15-95B416	6036837

WFL30

- **Fork width:** 30 mm

MDO	Switching output	Adjustment	Fork depth	Type	Part no.
0.05 mm	PNP/NPN	Teach-in	42 mm	WFL30-40B416	6036824
			59 mm	WFL30-60B416	6036831
			95 mm	WFL30-95B416	6036838

WFL50

- **Fork width:** 50 mm

MDO	Switching output	Adjustment	Fork depth	Type	Part no.
0.05 mm	PNP/NPN	Teach-in	42 mm	WFL50-40B416	6036825
			59 mm	WFL50-60B416	6036832
			95 mm	WFL50-95B416	6036839





**WFL80**

- **Fork width:** 80 mm

MDO	Switching output	Adjustment	Fork depth	Type	Part no.
0.05 mm	PNP/NPN	Teach-in	42 mm	WFL80-40B416	6036826
			59 mm	WFL80-60B416	6036833
			95 mm	WFL80-95B416	6036840

**WFL120**

- **Fork width:** 120 mm

MDO	Switching output	Adjustment	Fork depth	Type	Part no.
0.05 mm	PNP/NPN	Teach-in	42 mm	WFL120-40B416	6036827
			59 mm	WFL120-60B416	6036834
			95 mm	WFL120-95B416	6036841

**Dimensional drawing** (Dimensions in mm (inch))

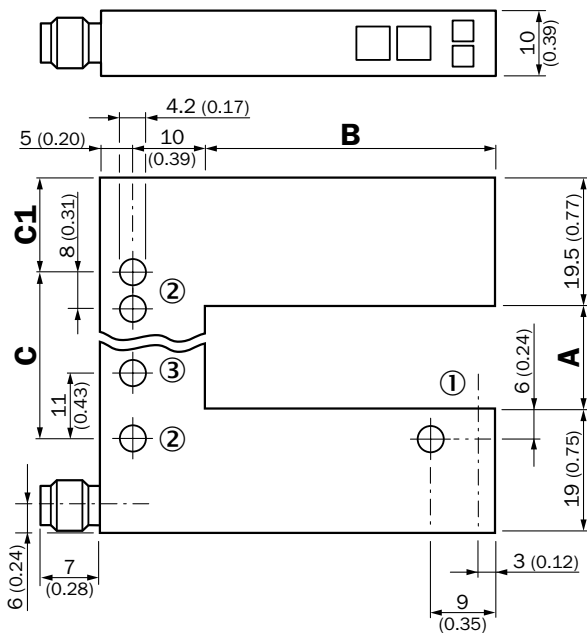

- ① Optical axis
- ② Mounting hole, Ø 4.2 mm
- ③ WFL50/80/120 only

**Dimensions in mm (inch)**

	A Fork width	B Fork depth	C	C1
<b>WFL2</b>	2 (0.08)	42/59/95 (1.65/2.32/3.74)	14 (0.55)	13.5 (0.53)
<b>WFL5</b>	5 (0.20)	42/59/95 (1.65/2.32/3.74)	14 (0.55)	15 (0.59)
<b>WFL15</b>	15 (0.59)	42/59/95 (1.65/2.32/3.74)	27 (1.06)	13.5 (0.53)
<b>WFL30</b>	30 (1.18)	42/59/95 (1.65/2.32/3.74)	42 (1.65)	13.5 (0.53)
<b>WFL50</b>	50 (1.97)	42/59/95 (1.65/2.32/3.74)	51 (2.01)	24.5 (0.96)
<b>WFL80</b>	80 (3.15)	42/59/95 (1.65/2.32/3.74)	81 (3.19)	24.5 (0.96)
<b>WFL120</b>	120 (4.72)	42/59/95 (1.65/2.32/3.74)	121 (4.76)	24.5 (0.96)



## Adjustments

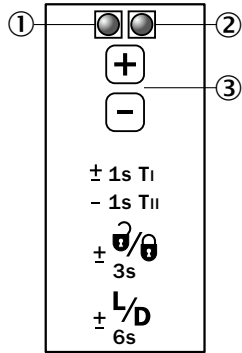

- ① Function signal indicator (yellow), switching output
- ② Function indicator (red)
- ③ “+”/“-” buttons and function button

## Connection diagram

Cd-086

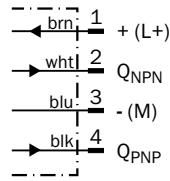

## Setting the switching threshold

Teach-in

The switching threshold is set automatically. Fine adjustment is possible using the “+”/“-” buttons.

### 1. No object or substrate in the beam path

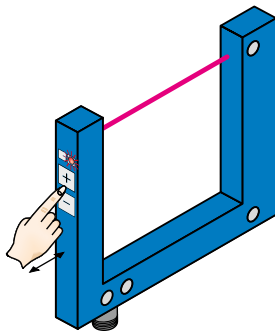

Press the “+” and “-” buttons together and hold for 1 second. The red function indicator flashes slowly.

### 2. Object or label in the beam path

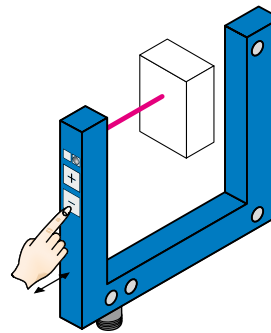

Press the “-” button for 1 second. Red function indicator goes out.

F

## Notes

Material speed = 0 (machine at a standstill).

- Once teach-in process is complete, the switching threshold can be adjusted at any time using the “+” or “-” button. To make minor adjustments, press the “+” or “-” button once.
- To configure settings quickly, keep the “+” or “-” button pressed for longer.

Press both the “+” and “-” buttons together (3 seconds) to lock the device and prevent unintentional actuation.



Press both the “+” and “-” buttons together (6 seconds) to define the switching function (light/dark switching). Standard setting:  $\bar{Q}$  = light switching.

## Recommended accessories

### Plug connectors and cables

Connecting cables with female connector

M8, 4-pin, PVC, chemical resistant

Figure	Connection type head A	Connection type head B	Connecting cable	Type	Part no.
	Female connector, M8, 4-pin, straight, unshielded	Cable, open conductor heads	2 m, 4-wire	DOL-0804-G02M	6009870
			5 m, 4-wire	DOL-0804-G05M	6009872
			10 m, 4-wire	DOL-0804-G10M	6010754
	Female connector, M8, 4-pin, angled, unshielded	Cable, open conductor heads	2 m, 4-wire	DOL-0804-W02M	6009871
			5 m, 4-wire	DOL-0804-W05M	6009873
			10 m, 4-wire	DOL-0804-W10M	6010755

→ For additional accessories, please see page K-240

# WFM – CONNECT AND GET STARTED



## Product description

WFM fork sensors can be integrated quickly due to Plug and Play installation – no time-consuming alignment is necessary. A 360-degree output indicator makes it easy to see the switching status during the operation. Since the sender and receiver of the sensor are integrated within the same aluminum housing, aligning the sensors is not necessary and detection tasks can be

prepared and solved even faster. The WFM line includes five different types with fork widths from 30 to 180 mm and fork depths from 40 to 120 mm, providing greater application flexibility. This generation of SICK fork sensors is suited for a variety of applications, such as detecting parts in production processes or checking presence when filling bottles.

## At a glance

- Highly visible red emitted light
- No setup, out-of-the-box operation
- 360° output indicator
- 5 fork sizes: maximum depth 120 mm, maximum width 180 mm
- Rugged, IP 67 aluminum housing

## Your benefits

- Fixed housings guarantee a high level of operational safety with simple commissioning
- A visible red light enables easy alignment and fast adjustment
- The 360-degree yellow output indicator makes continual process control possible
- A wide range of different fork sizes increases installation flexibility
- The aluminum housing meets all requirements for use in harsh industrial conditions



## Additional information

Detailed technical data . . . . . F-189  
 Ordering information . . . . . F-190  
 Connection diagram . . . . . F-191  
 Dimensional drawing . . . . . F-191  
 Recommended accessories . . . . F-192

→ [www.sick.com/de/en/WFM](http://www.sick.com/de/en/WFM)

For more information, just enter the link or scan the QR code and get direct access to technical data, CAD design models, operating instructions, software, application examples and much more.



F

## Detailed technical data

### Features

<b>Functional principle</b>	Optical detection principle
<b>Housing design (light emission)</b>	Fork shaped
<b>Fork width</b>	30 mm ... 180 mm (depending on type)
<b>Fork depth</b>	42 mm ... 124 mm (depending on type)
<b>Minimum detectable object (MDO)</b>	0.8 mm / 1 mm (depending on type)
<b>Light source</b>	LED
<b>Type of light</b>	Visible red light
<b>Adjustment</b>	None
<b>Output function</b>	Dark switching / Light switching (depending on type)

### Mechanics/electronics

<b>Supply voltage</b> <sup>1)</sup>	10 V DC ... 30 V DC
<b>Ripple</b> <sup>2)</sup>	< 10 %
<b>Power consumption</b> <sup>3)</sup>	< 20 mA
<b>Switching frequency</b> <sup>4)</sup>	4 kHz
<b>Response time</b> <sup>5)</sup>	125 µs
<b>Stability of response time</b>	± 15 µs
<b>Switching output</b>	PNP: HIGH = $V_S - \leq 1.5 \text{ V}$ / LOW = 0 V NPN: HIGH = approx. $V_S$ / LOW $\leq 1.5 \text{ V}$
<b>Output type</b>	PNP / NPN (depending on type)
<b>Output current <math>I_{\text{max}}</math></b>	100 mA
<b>Initialization time</b>	140 ms
<b>Connection type</b>	Connector M8, 3-pin / Cable, 3-wire, 2 m (depending on type)
<b>Ambient light safety</b>	Sunlight: $\leq 10,000 \text{ klx}$
<b>Protection class</b> <sup>6)</sup>	III
<b>Circuit protection</b>	$V_S$ connections reverse-polarity protected, Output Q short-circuit protected, Interference suppression
<b>Enclosure rating</b>	IP 67
<b>Weight</b> <sup>7)</sup>	Approx. 80 g ... 190 g
<b>Housing material</b>	Metal, Aluminum

<sup>1)</sup> Limit values, reverse-polarity protected, operation in short-circuit protected network: max. 8 A.

<sup>2)</sup> May not exceed or fall below  $U_V$  tolerances.

<sup>3)</sup> Without load.

<sup>4)</sup> With light/dark ratio 1:1.

<sup>5)</sup> Signal transit time with resistive load.

<sup>6)</sup> Reference voltage DC 50 V.

<sup>7)</sup> Depending on fork width.

### Ambient data

<b>Ambient operating temperature</b> <sup>1)</sup>	-10 °C ... +60 °C
<b>Ambient storage temperature</b>	-40 °C ... +80 °C
<b>Shock load</b>	According to EN 60068-2-27
<b>UL File No.</b>	NRKH.E191603 & NRKH7.E191603

<sup>1)</sup> Do not bend below 0 °C.

## Ordering information

Other models → [www.sick.com/de/en/WFM](http://www.sick.com/de/en/WFM)

### WFM30-40

- **Fork width:** 30 mm
- **Fork depth:** 42 mm

MDO <sup>1)</sup>	Connection type	Switching output	Output function	Type	Part no.
0.8 mm	Connector M8, 3-pin	PNP	Dark switching	WFM30-40P321	6037819
			Light switching	WFM30-40P311	6037820
		NPN	Dark switching	WFM30-40N321	6037821
			Light switching	WFM30-40N311	6037822
	Cable, 3-wire 2 m	PNP	Dark switching	WFM30-40P121	6037823

<sup>1)</sup> Minimum detectable object.

### WFM50-60

- **Fork width:** 50 mm
- **Fork depth:** 60 mm

MDO <sup>1)</sup>	Connection type	Switching output	Output function	Type	Part no.
0.8 mm	Connector M8, 3-pin	PNP	Dark switching	WFM50-60P321	6037824
			Light switching	WFM50-60P311	6037825
		NPN	Dark switching	WFM50-60N321	6037826
			Light switching	WFM50-60N311	6037827

<sup>1)</sup> Minimum detectable object.

F

### WFM80-60

- **Fork width:** 80 mm
- **Fork depth:** 60 mm

MDO <sup>1)</sup>	Connection type	Switching output	Output function	Type	Part no.
0.8 mm	Connector M8, 3-pin	PNP	Dark switching	WFM80-60P321	6037828
			Light switching	WFM80-60P311	6037829
		NPN	Dark switching	WFM80-60N321	6037830
			Light switching	WFM80-60N311	6037831

<sup>1)</sup> Minimum detectable object.

### WFM120-120

- **Fork width:** 120 mm
- **Fork depth:** 124 mm

MDO <sup>1)</sup>	Connection type	Switching output	Output function	Type	Part no.
0.8 mm	Connector M8, 3-pin	PNP	Dark switching	WFM120-120P321	6037832
			Light switching	WFM120-120P311	6037833
		NPN	Dark switching	WFM120-120N321	6037834
			Light switching	WFM120-120N311	6037835

<sup>1)</sup> Minimum detectable object.

WFM180-120

- **Fork width:** 180 mm
- **Fork depth:** 124 mm

MDO <sup>1)</sup>	Connection type	Switching output	Output function	Type	Part no.
1 mm	Connector M8, 3-pin	PNP	Dark switching	WFM180-120P321	6037836
			Light switching	WFM180-120P311	6037837
		NPN	Dark switching	WFM180-120N321	6037838
			Light switching	WFM180-120N311	6037839

<sup>1)</sup> Minimum detectable object.

Dimensional drawing (Dimensions in mm (inch))

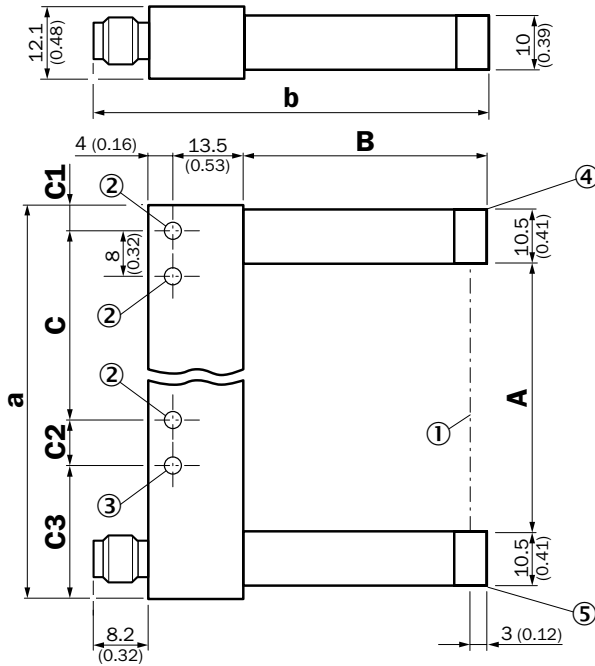

Dimensions in mm (inch)

	A Fork width	B Fork depth	C	C1
<b>WFM30</b>	30 (1.18)	42 (1.65)	30 (1.18)	6.5 (0.26)
<b>WFM50</b>	50 (1.97)	60 (2.36)	40 (1.57)	6.5 (0.26)
<b>WFM80</b>	80 (3.15)	60 (2.36)	70 (2.76)	6.5 (0.26)
<b>WFM120</b>	120 (4.72)	124.3 (4.89)	100 (3.94)	17 (0.67)
<b>WFM180</b>	180 (7.09)	124.3 (4.89)	152 (5.98)	22 (0.87)
	C2	C3	a	b
<b>WFM30</b>	- (-)	- (-)	54 (2.13)	67.7 (2.67)
<b>WFM50</b>	8 (0.31)	19.5 (0.77)	74 (2.91)	85.7 (3.37)
<b>WFM80</b>	8 (0.31)	19.5 (0.77)	104 (4.09)	85.7 (3.37)
<b>WFM120</b>	10 (0.39)	17 (0.67)	144 (5.67)	150.2 (5.91)
<b>WFM180</b>	8 (0.31)	22 (0.87)	204 (8.03)	150.2 (5.91)

- ① Optical axis
- ② Mounting hole, Ø 4.3 mm
- ③ WFM50/80/120/180
- ④ Transmitted light (red)
- ⑤ Function signal indicator (yellow), switching output

Connection diagram

Cd-045

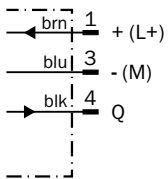



Recommended accessories

Plug connectors and cables

Connecting cables with female connector

M8, 3-pin, PVC, chemical resistant

Figure	Connection type head A	Connection type head B	Connecting cable	Type	Part no.
	Female connector, M8, 3-pin, straight, unshielded	Cable, open conductor heads	2 m, 3-wire	DOL-0803-G02M	6010785
			5 m, 3-wire	DOL-0803-G05M	6022009
			10 m, 3-wire	DOL-0803-G10M	6022011
	Female connector, M8, 3-pin, angled, unshielded	Cable, open conductor heads	2 m, 3-wire	DOL-0803-W02M	6008489
			5 m, 3-wire	DOL-0803-W05M	6022010
			10 m, 3-wire	DOL-0803-W10M	6022012

→ For additional accessories, please see page K-240

F



**F**



## REGISTER SENSORS



G

### Register control does the work in tough print mark applications

The register sensor line complements our wide range of contrast sensors. As specialists in the register control of printing presses they offer an optimal solution to detect marks in tough print conditions with extremely low contrast, complex colorful printouts or at very high speeds. Our range of register

sensors also includes an ATEX certified fiber-optic product, ensuring safe solutions in hazardous areas (e.g. when using solvent based ink).

#### Your benefits

- Solution for explosive gas areas (ATEX certificate)

- High precision to enhance print quality
- Reliable print quality systems at high speeds
- Cost-saving potential with less material waste and less production conversion time



<b>General information</b> . . . . .	<b>.G-196</b>
<b>Product family overview</b> . . . . .	<b>.G-199</b>



<b>RS10</b> . . . . .	<b>.G-200</b>
Adjustable individual thresholds	



<b>RS25</b> . . . . .	<b>.G-206</b>
For best performance even in hazardous areas!	

# IF IT DOESN'T FIT, WE'LL MAKE IT FIT

As in every industry, the printing industry needs an expert with a sharp eye for results. During continuous operations – at very high speeds – SICK register sensors make sure that nothing unsuitable gets through.

Color accuracy is the most important factor in achieving top results in printed products. To ensure this, the intake of the material to be printed must be precisely regulated. Activated by the machine's register control, the register sensors check every single printout as well as the distance and width of printed control

marks. If the control mark is not exactly where it should be, the entire print result will be considered unsuitable. The machine's register control uses the position deviations detected by the register sensors to correct the printout. SICK register sensors deal with all of this – what can we say, they're control freaks!



G

## EVERYTHING WASTED? NOT WITH US.

Register sensors detect printed control marks at full production speed. If a sensor detects deviations, this information is used to automatically correct printouts, for example. This is known as automatic register control.



### Function of register control

Register controls ensure an accurate infeed of material from one printout to the next for all types of printing press. To obtain a sharp print image, the individual colors must be printed accurately over matching layers. In each color run, a control mark is printed that is detected by the quick and precise register sensors. They measure both the distance between one mark and the next and the width of the marks.

The distance between the marks indicates whether the length of the print is correct (longitudinal register). The width of the marks is required to regulate the side register. The longitudinal register can be modified via a positioning roller between the printouts, which alters the length of the paper flow to the next printout. To adjust the side register, the print roller is moved to the right or left. The register sensors control all of this with lightning speed, preventing wastage.

G

#### Detecting an incorrect longitudinal register

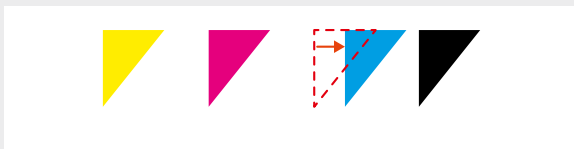

#### Configuring the printing machine via a positioning roller

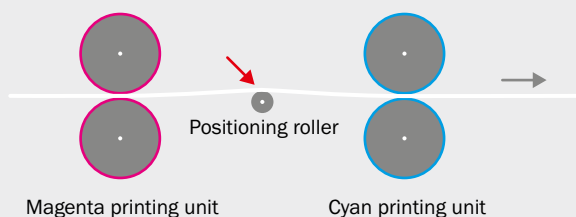

#### Detecting an incorrect side register

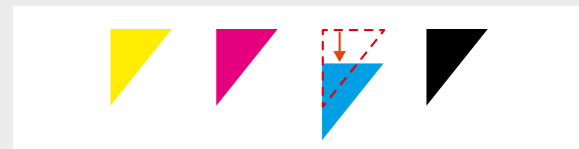

#### Configuring the printing machine via a print roller

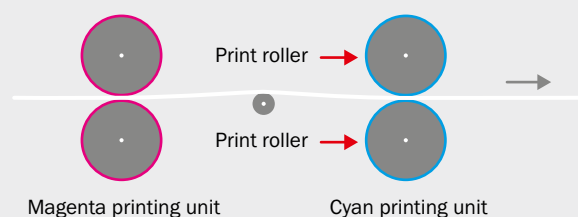

## INCREASING PROCESS SPEED AND EFFICIENCY

SICK register sensors reduce wastage and thus increase productivity and efficiency in the printing business. They even reduce costs during printing plate mounting and commissioning.

### RS10



The RS10 register sensor is perfect for detecting minor contrasts and lots of different colors. With an integrated register control system and configurable individual switching threshold, a sensor can detect up to 18 marks.

Because it is mounted with a simple screw, the RS10 is ready to use in just a short time.

### RS25





The RS25 register sensor is impressively simple and quick to use and features automatic teach-in mechanisms. This reduces machine setup and conversion times. It consists of a sensor head, fibers, and evaluation unit. Using an RGB light ensures excellent reading quality.

The RS25 register sensor is ATEX-certified and ideal for use in areas that contain explosive gases, e.g. where solvent-based colors are used. Communication via Ethernet POWERLINK enables the sensor to be easily incorporated into the machine operating concept.



## PRODUCT FAMILY OVERVIEW

	 <p style="text-align: center;"><b>RS10</b></p> <p style="text-align: center;">Adjustable individual thresholds</p>	 <p style="text-align: center;"><b>RS25</b></p> <p style="text-align: center;">For best performance even in hazardous areas!</p>
---	--	---

Technical data overview		
Sensing distance	13 mm	10 mm
Light source	LED	LED
Type of light	Visible white light	Visible red light, visible green light, visible blue light
Response time	≤ 20 μs	-
Output type	PNP/NPN, push-pull	-

At a glance		
	<ul style="list-style-type: none"> <li>• The register is controlled with individual thresholds</li> <li>• Unique housing: one screw mounting</li> <li>• Tight dual-sensor mounting ability</li> <li>• Detects 1-18 marks of different colors</li> <li>• Easy teach-in via button</li> </ul>	<ul style="list-style-type: none"> <li>• PLC embedded register control</li> <li>• Multi LED (RGB)</li> <li>• Fast communication via Ethernet Powerlink</li> <li>• Very high repeatability (≤ 40 μm)</li> <li>• Detects up to 20 marks of different colors</li> <li>• Reading window for improved reliability</li> </ul>

Detailed information	→ G-200	→ G-206
----------------------	---------	---------



# ADJUSTABLE INDIVIDUAL THRESHOLDS



## Product description

The RS10 is ideal for detecting print marks with low contrast or handling register marks with many different colors due to its individual threshold adjustment feature. Single screw mounting

makes it easy to integrate and adjust in the machine. The round-shaped, white LED improves accuracy at high speeds. Up to 18 marks can be handled by the embedded register control system.

## At a glance

- The register is controlled with individual thresholds
- Unique housing: one screw mounting
- Tight dual-sensor mounting ability
- Detects 1-18 marks of different colors
- Easy teach-in via button

## Your benefits

- Better performance in low contrast applications or with many color marks (>8)
- Unique housing allows for quick mounting and adjustment
- Dual sensors detect a double columns of marks
- Fast teach procedure for less downtime on the production line



## Additional information

Detailed technical data . . . . .	G-201
Ordering information . . . . .	G-201
Dimensional drawing . . . . .	G-202
Connection diagram . . . . .	G-202
Assembly note . . . . .	G-202
Functional principle . . . . .	G-203
Flow diagram . . . . .	G-203
Sensing distance . . . . .	G-204
Recommended accessories . . .	G-204

→ [www.sick.com/de/en/RS10](http://www.sick.com/de/en/RS10)

For more information, just enter the link or scan the QR code and get direct access to technical data, CAD design models, operating instructions, software, application examples and much more.



G



## Detailed technical data

## Features

Dimensions (W x H x D)	15 mm x 62 mm x 60 mm
Sensing distance	13 mm
Housing design (light emission)	Rectangular
Sensing distance tolerance	± 1 mm
Light source <sup>1)</sup>	LED
Type of light	Visible white light
Wave length	450 nm ... 650 nm

<sup>1)</sup> Average service life: 100,000 h at T<sub>U</sub> = +25 °C.

## Mechanics/electronics

Supply voltage <sup>1)</sup>	10 V DC ... 30 V DC
Ripple <sup>2)</sup>	≤ 5 V <sub>pp</sub>
Power consumption <sup>3)</sup>	< 100 mA
Response time <sup>4)</sup>	≤ 20 μs
Jitter	≤ 10 μs
Output type	PNP/NPN, push-pull
Output current I <sub>max.</sub>	< 100 mA
Input, teach-in (ET)	Run: U < 2 V Teach: U = 10 V ... < U <sub>V</sub>
Connection type	Male connector M12, 8-pin
Protection class <sup>5)</sup>	II
Circuit protection	V <sub>S</sub> connections reverse-polarity protected, Interference suppression, Outputs overcurrent and short-circuit protected
Enclosure rating	IP 67
Weight	400 g
Housing material	Metal, aluminum (anodised)

<sup>1)</sup> Limit values; operation in short-circuit protected network max. 8 A.

<sup>2)</sup> May not exceed or fall below U<sub>V</sub> tolerances.

<sup>3)</sup> Without load.

<sup>4)</sup> Signal transit time with resistive load.

<sup>5)</sup> Reference voltage DC 32 V.

## Ambient data

Ambient operating temperature	-10 °C ... +60 °C
Ambient storage temperature	-25 °C ... +75 °C
Shock load	According to IEC 60068

## Ordering information

Other models → [www.sick.com/de/en/RS10](http://www.sick.com/de/en/RS10)

Sensing distance	Response time <sup>1)</sup>	Output type	Type	Part no.
13 mm	≤ 20 μs	PNP/NPN, push-pull	RS10-M111	1060116

<sup>1)</sup> Signal transit time with resistive load.

Dimensional drawing (Dimensions in mm (inch))

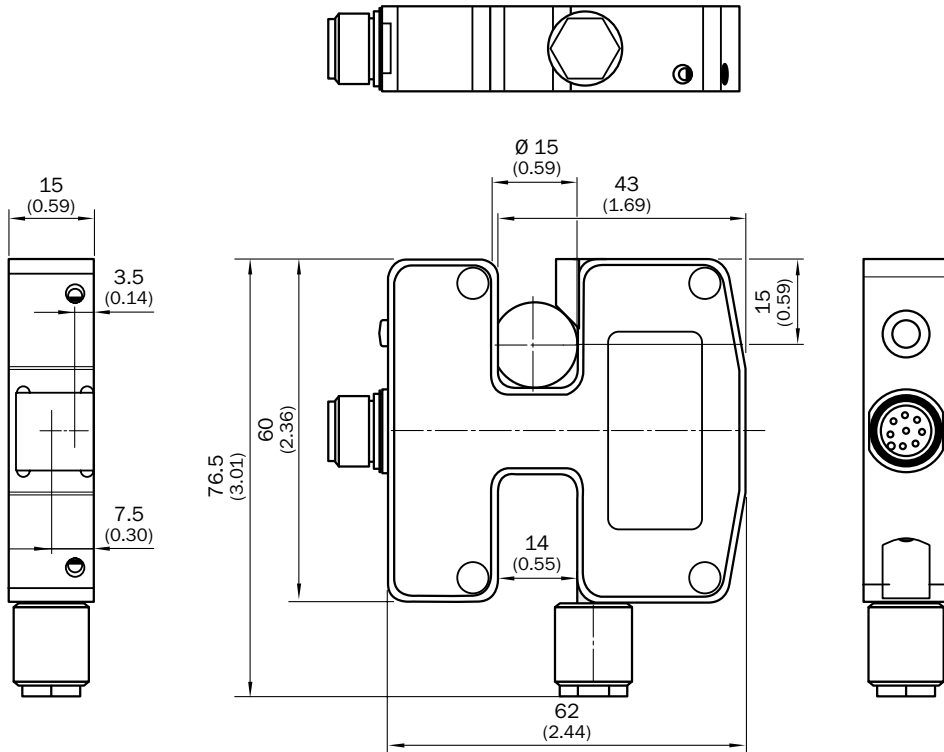

Connection diagram

Cd-316

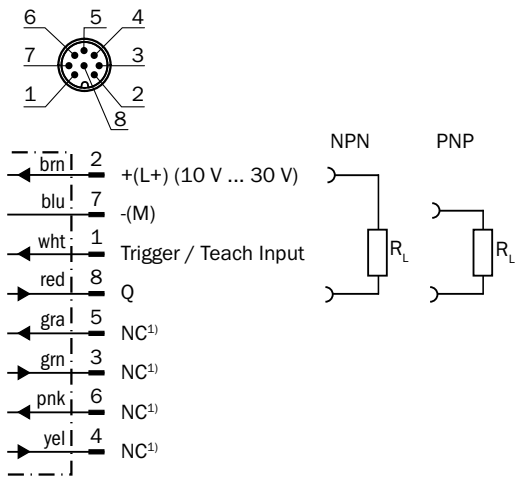

① Not connected. Leave open, do not wire to ground.

Assembly note

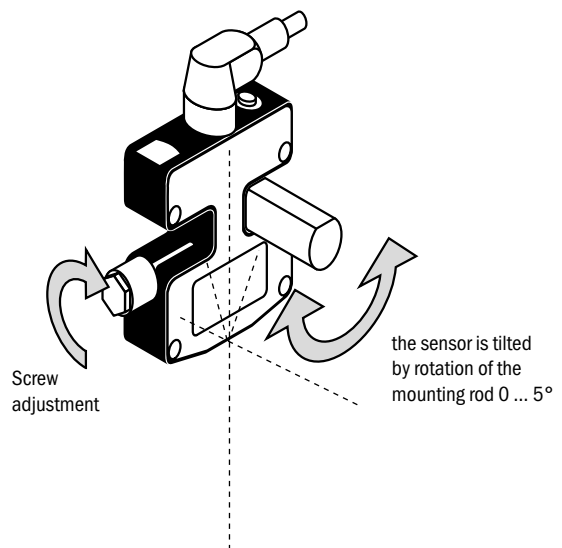

G

Functional principle

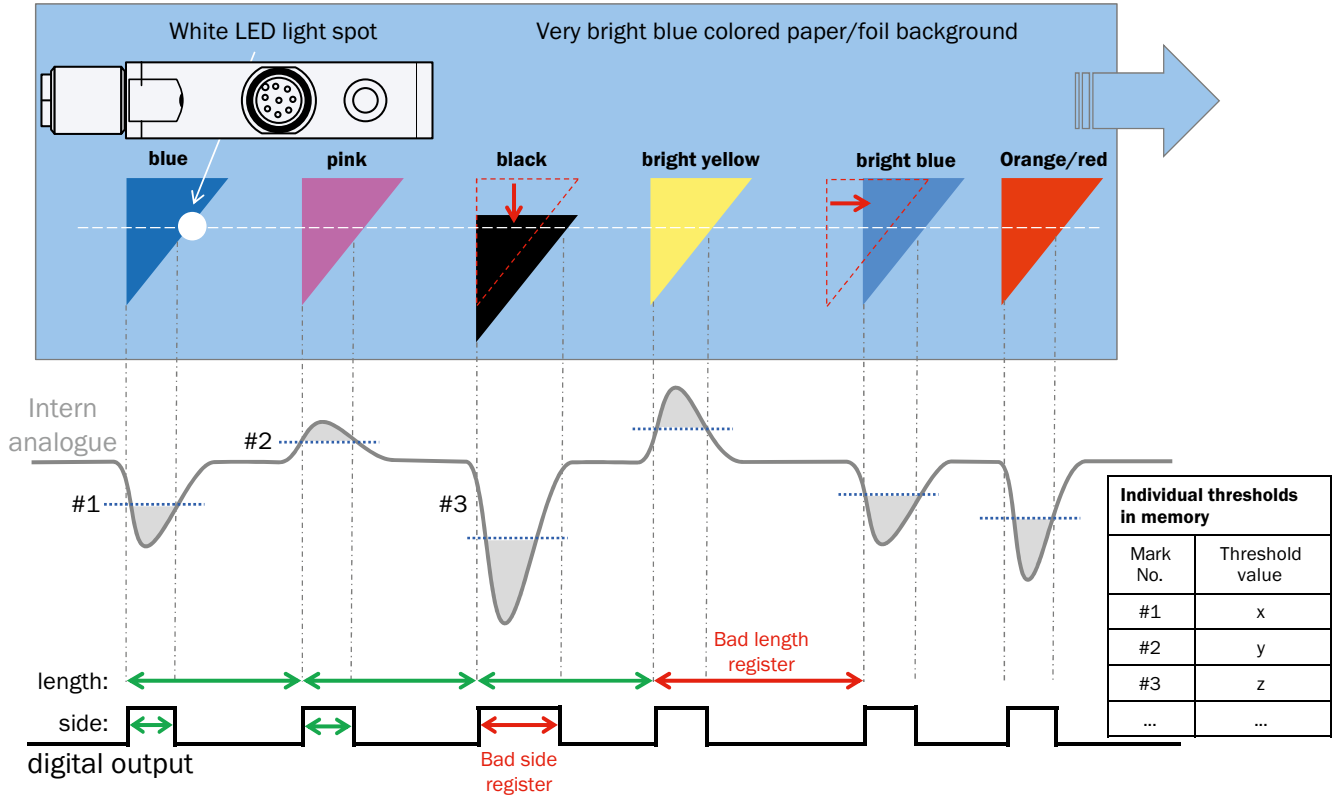

Flow diagram

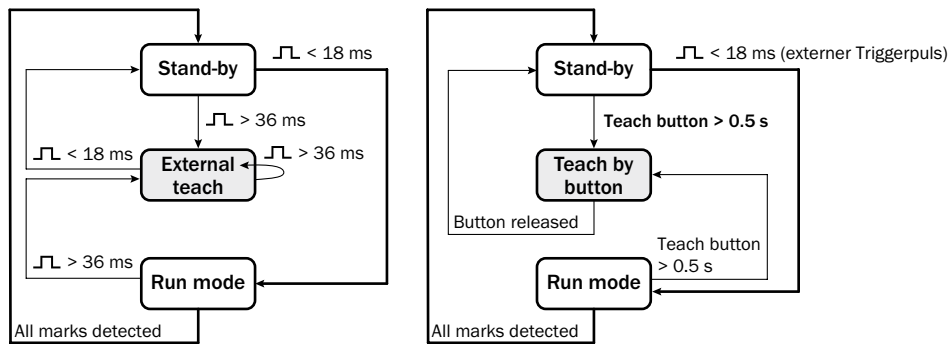

Sensing distance

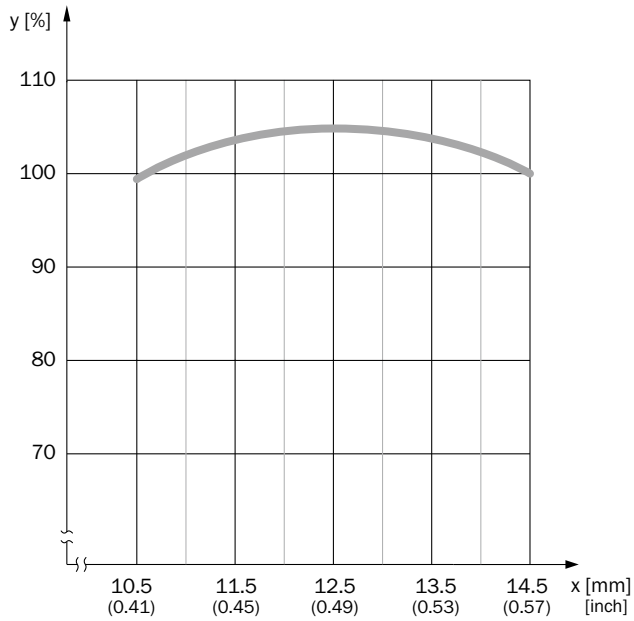



Recommended accessories

Plug connectors and cables

Connecting cables with female connector

M12, 8-pin, PUR, halogen-free

Figure	Connection type head A	Connection type head B	Connecting cable	Type	Part no.
	Female connector, M12, 8-pin, straight, shielded	Cable, open conductor heads	2 m, 8-wire	DOL-1208-G02MAH1	6032448
	Female connector, M12, 8-pin, angled, shielded	Cable, open conductor heads	2 m, 8-wire	DOL-1208-W02MAS01	6029224

→ For additional accessories, please see page K-240

G



# FOR BEST PERFORMANCE EVEN IN HAZARDOUS AREAS!



## Product description

The RS25 can be used in various print mark processes and the fiber-optic ATEX certified version is ideal in explosive gas environments. The sensor has extremely low jitter in combination with fast

communication via EthernetPowerlink, resulting in a very high repeatability. The multicolored LED is adapted to each mark to get the best possible contrast.

## At a glance

- PLC embedded register control
- Multi LED (RGB)
- Fast communication via Ethernet Powerlink
- Very high repeatability ( $\leq 40 \mu\text{m}$ )
- Detects up to 20 marks of different colors
- Reading window for improved reliability

## Your benefits

- High precision to enhance print quality
- Sensor for explosive gas areas – ATEX certified
- Flexible solution via the PLC embedded register control unit
- Cost-saving potential with less material waste and less production conversion time



## Additional information

Detailed technical data . . . . . G-207  
 Ordering information . . . . . G-208  
 Dimensional drawings . . . . . G-208  
 Connection diagram. . . . . G-209  
 Functional principle . . . . . G-210  
 Flow diagram. . . . . G-210  
 Recommended accessories . . . G-211

→ [www.sick.com/de/en/RS25](http://www.sick.com/de/en/RS25)

For more information, just enter the link or scan the QR code and get direct access to technical data, CAD design models, operating instructions, software, application examples and much more.



G

## Detailed technical data

## Features

	Evaluation unit	Optical sensor head
Dimensions (W x H x D)	100 mm x 47 mm x 200 mm	30 mm x 15 mm x 40 mm
Sensing distance	10 mm	-
Housing design (light emission)	Rectangular	
Sensing distance tolerance	± 1 mm	
Light source	LED	
Type of light	Visible red light, visible green light, visible blue light	
Maximum No. of marks in register	20	-
Start code	Configurable	-
Data interface	Ethernet POWERLINK	-

## Mechanics/electronics

	Evaluation unit	Optical sensor head
Supply voltage <sup>1)</sup>	12 V DC ... 30 V DC	-
Ripple <sup>2)</sup>	≤ 5 V <sub>pp</sub>	
Power consumption <sup>3)</sup>	< 250 mA	-
Accuracy	40 µm	-
Connection type	Connector M12, 4-pin	-
Protection class <sup>4)</sup>	III	-
Circuit protection	V <sub>S</sub> connections reverse-polarity protected, Interference suppression, Outputs overcurrent and short-circuit protected	-
Housing	-	Quadratic
Window material	-	Glass
Fiber length	-	3,200 mm
Diameter of fiber	-	8 mm
Bending radius (static)	-	40 mm
Bending radius (dynamic)	-	80 mm
Fieldbus interface	Ethernet POWERLINK	-
Enclosure rating	IP 65	
Weight	1,000 g	450 g
ATEX approval	- / ✓ (depending on type)	✓
ATEX marking	Ex II (2)G [Ex op is Gb] IIB	Ex II 2G Ex op is IIB T4 Gb
Housing material	Metal, aluminum	Metal, aluminum alloy, sandblasted

<sup>1)</sup> Limit values; operation in short-circuit protected network max. 8 A.

<sup>2)</sup> May not exceed or fall below U<sub>v</sub> tolerances.

<sup>3)</sup> Without load.

<sup>4)</sup> Reference voltage DC 50 V.

## Ambient data

	Evaluation unit	Optical sensor head
Ambient operating temperature	-10 °C ... +55 °C	
Ambient storage temperature	-20 °C ... +70 °C	
Shock load	According to IEC 60068	-

## Ordering information

Other models → [www.sick.com/de/en/RS25](http://www.sick.com/de/en/RS25)

Sensing distance	ATEX marking	Type	Part no.
10 mm	-	RS25-WF334000	1062005
	Ex II (2)G [Ex op is Gb] IIB	RS25-WL334000	1061571
-	Ex II 2G Ex op is IIB T4 Gb	RS25 - optical sensor head	-

## Dimensional drawings (Dimensions in mm (inch))

Evaluation unit

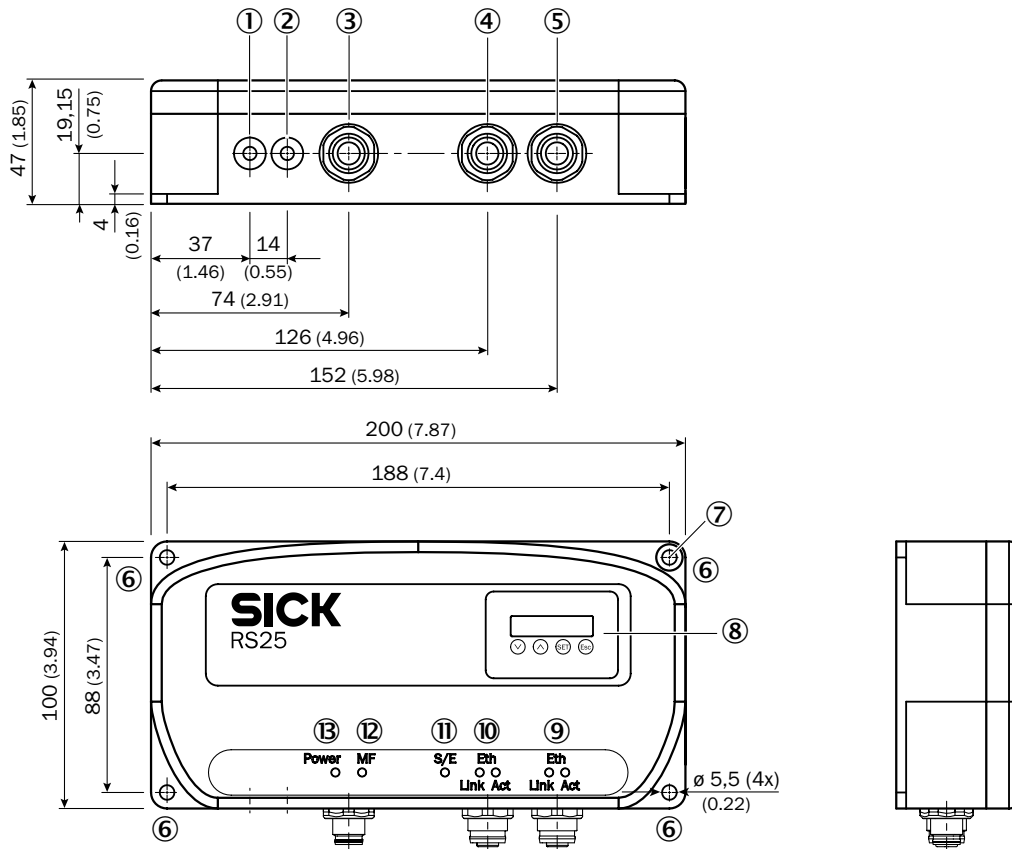

- ① Connection optical sensor head receiver
- ② Connection optical sensor head sender
- ③ Anschluss supply voltage
- ⑥ Mounting hole
- ⑨ LED function indicator (green) "Eth, Link and Act"
- ⑩ LED function indicator (green) "Eth, Link and Act"
- ⑪ LED function indicator (green/red) "S/E"
- ⑫ LED function indicator (yellow) "MF"
- ⑬ LED function indicator (green) "Power"



Optical sensor head

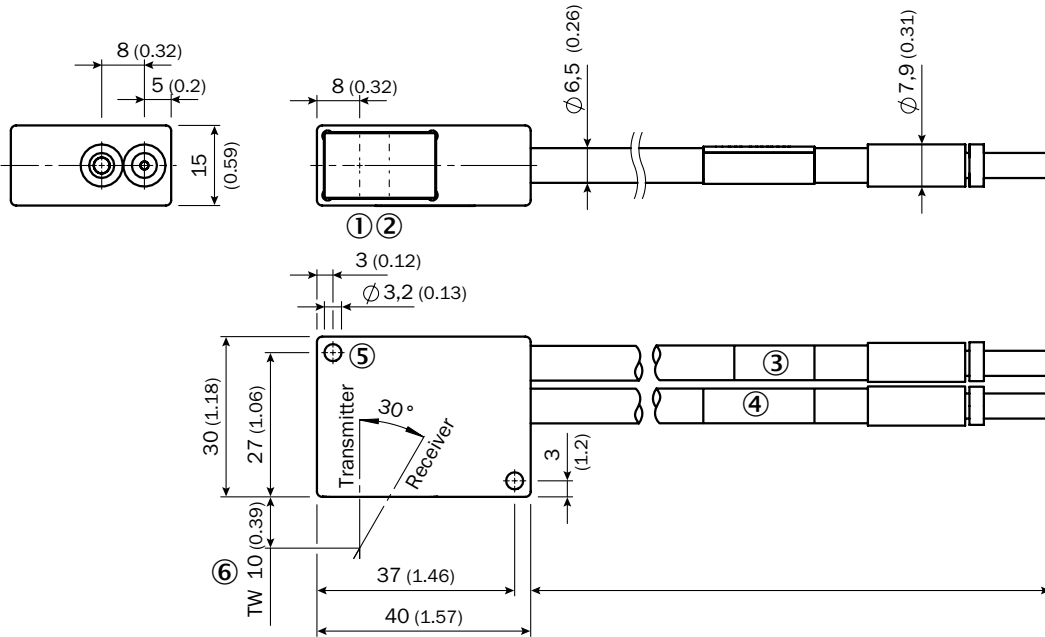

- ① Optical axis sender
- ② Optical axis receiver
- ⑤ Mounting hole
- ⑥ Sensing distance 10 mm

Connection diagram

Cd-317

Voltage supply

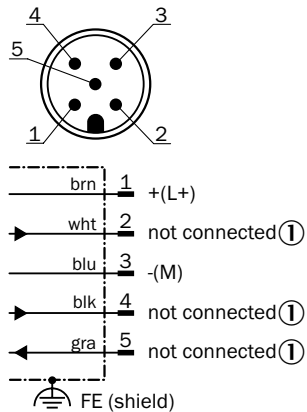

M12 (A-coded)

① Not connected

Cd-318

Ethernet POWERLINK

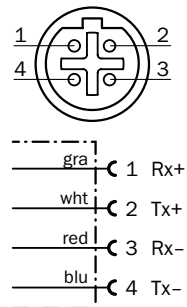

M12 (D-coded)



Functional principle

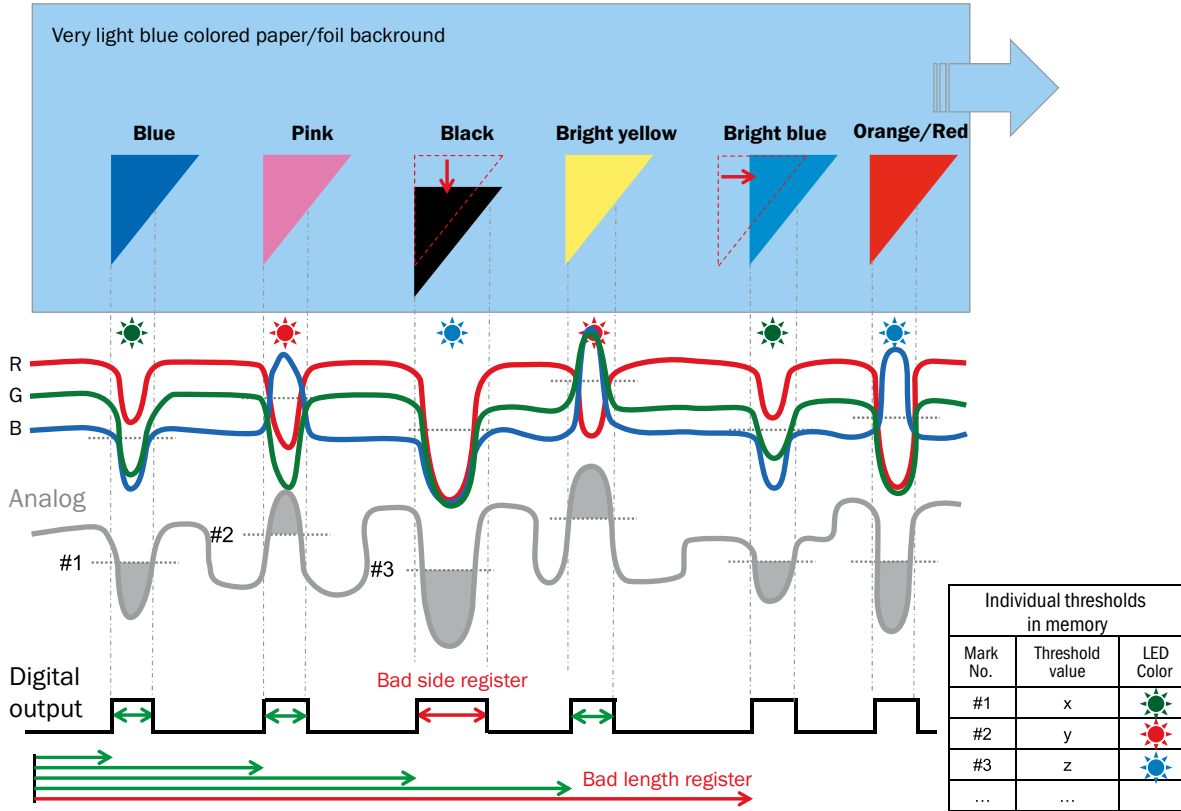

Flow diagram

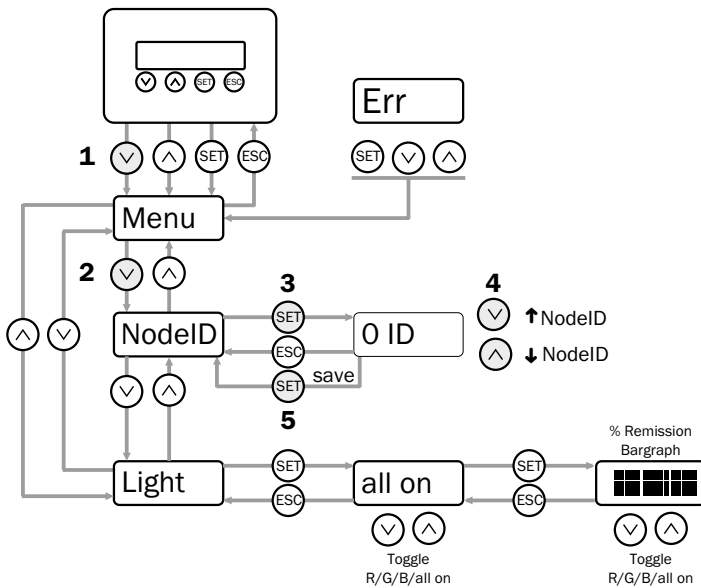

6. Perform a restart. This is done by switching the supply voltage off and then on again after 5 seconds.

The register sensor is ready to communicate with the control (PLC).

G

## Recommended accessories

### Plug connectors and cables

Connecting cables with female connector

M12, 5-pin, PUR, halogen-free, Oil / grease resistant

Figure	Connection type head A	Connection type head B	Connecting cable	Type	Part no.
	Female connector, M12, 5-pin, straight, shielded	Cable, open conductor heads	5 m, 5-wire	DOL-1205-G05MAC	6036384
			10 m, 5-wire	DOL-1205-G10MAC	6036385
			20 m, 5-wire	DOL-1205-G20MAC	6036386

Connection cables with male connector and male connector

M12, 4-pin, PUR, Ethernet

Figure	Connection type head A	Connection type head B	Connecting cable	Type	Part no.
	Male connector, M12, 4-pin, straight, D-coded, shielded	Male connector, RJ45, 8-pin, straight	2 m, 4-wire, AWG26	SSL-2J04-G02ME	6034414
			5 m, 4-wire, AWG26	SSL-2J04-G05ME	6035389
			10 m, 4-wire, AWG26	SSL-2J04-G10ME	6030928
			20 m, 4-wire, AWG26	SSL-2J04-G20ME	6036158
			25 m, 4-wire, AWG26	SSL-2J04-G25ME	6033555

M12, 4-pin, PUR, halogen-free, EtherNet/IP

Figure	Connection type head A	Connection type head B	Connecting cable	Type	Part no.
	Male connector, M12, 4-pin, straight, D-coded, shielded	Male connector, M12, 4-pin, straight, D-coded	2 m, 4-wire, CAT5, CAT5e	SSL-1204-G02ME90	6045222
			5 m, 4-wire, CAT5, CAT5e	SSL-1204-G05ME90	6045277
			10 m, 4-wire, CAT5, CAT5e	SSL-1204-G10ME90	6045279

→ For additional accessories, please see page K-240



## ARRAY SENSORS



H

### Ax20 array sensors for edge and diameter detection solutions

Array sensors use closely spaced beams of light to detect even the slightest differences in gray scale between the target and the background within their field-of-view. They are ideal for edge and diameter detection as well as detecting widths and gaps. SICK's array sensors offer industry-leading reproducibility, in addition to compact, rugged metal housings for use in highly restricted or harsh environments.

#### Your benefits

- Cost-effective solution to reliably determine edge position and width measurement
- Easy-to-integrate, compact housing can be mounted over the web so less downtime is required for maintenance
- No reflector is required, reducing maintenance and providing greater product reliability. Reduces downtime. Only array sensors available in diffuse mode, making them ideal for environments where dirt and dust can interfere with other types of solutions that require a reflector.
- High reproducibility of 0.03 mm and industry-leading resolution enable greater accuracy and quality control
- Highly visible white LED light spot ensures fast and accurate alignment, reducing time-consuming fine adjustment
- No teach, program or menu activities make setup virtually hassle free



General information . . . . .	.H-214
Product family overview . . . . .	.H-217



<b>Ax20 . . . . .</b>	<b>.H-218</b>
Ax20 array sensors for edge and diameter detection solutions	

## FURTHER AHEAD, LINE FOR LINE

The SICK array sensor is the ideal solution for accurate web edge and line tracing. Be it positioning print marks, controlling web edges, or monitoring consistent diameters, the Ax20's measuring principle of operation makes it the perfect solution.

SICK array sensors are the first choice for precise detection and tracing of contrast variations. They work on the proximity principle and can detect even the smallest grayscale variations in the visible area. In the measurement

field of up to 30 mm, even minuscule changes in contrast are precisely detected, traced, and output via an analog value accurate up to 30  $\mu\text{m}$ .



H

## TYPICAL APPLICATIONS

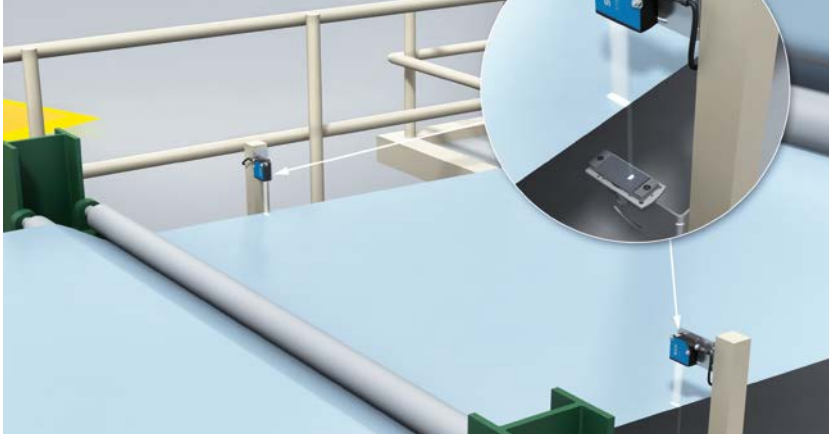

### Edge detection and web edge tracing

The Ax20 traces the position of web edges and detects the lateral position of the paper or foil web.

Ax20 array sensors enable precise web edge control. They offer a high repeatability of 30 µm and can detect even the smallest grayscale variations in their visible area.

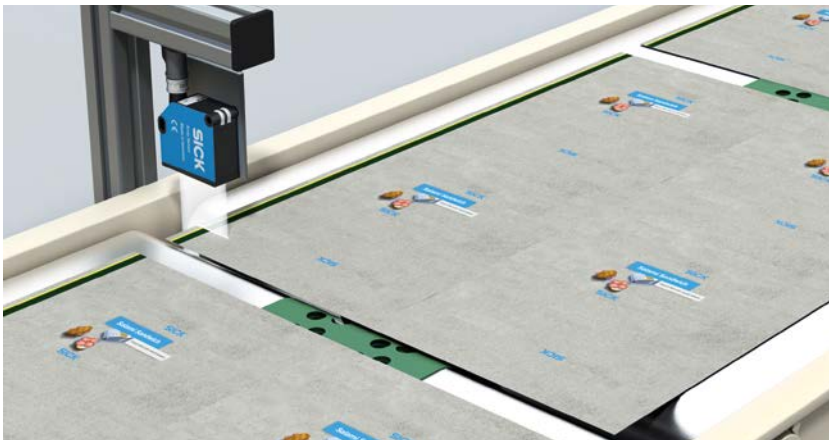

### Optical engagement

The AT20 array sensor registers the position of the sheet edge and thus regulates the sheet position.

It detects the position of a sheet edge and supplies an analog signal that is proportional to this position. This enables control of the sheet position and sheet travel with an accuracy of 30 µm.



### Object positioning

The quick and precise detection of the leading edge of objects, e.g. circuit boards, enables reliable positioning and loading processes.

The AT20 proximity array sensor positions a sheet based on the printed mark or the print image. This procedure does not require a reflector. A further advantage of the proximity principle is that the sheets are punched precisely to match the image. This eliminates the tolerance to the edge of the sheet.

H

### Your benefits

- Cost-effective solution for edge and diameter detection
- Resistant to environmental factors, e.g. dust by using proximity principle
- Less machine downtime
- Detection of many different materials, e.g. transparent foils
- Easy operation
- Visible light spot

## TECHNOLOGY

### Precisely detect contrast changes

The Ax20 array sensor works according to the proximity principle. Within the measurement field of up to 30 mm, changes in contrast are precisely detected, traced, and output via an analog value accurate up to 30 µm. With its extremely compact and sturdy metal housing, the sensor can be used in very tight or awkward spaces.

The benefits of the Ax20 at a glance

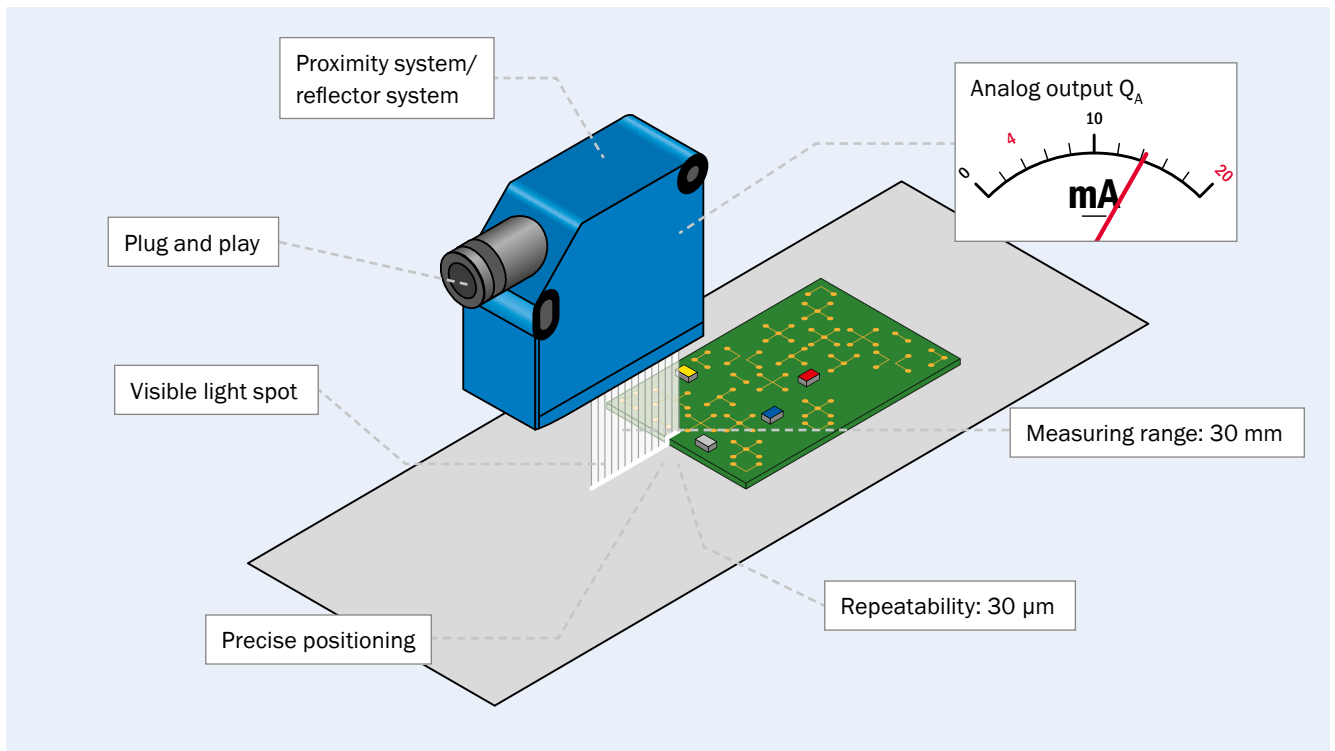

## H

Which sensor for which contrast change

AT20 with Reflektor



≥ 10 %

AL20 with Reflektor



≥ 17 %

AT20 without Reflektor



≥ 20 %



# PRODUCT FAMILY OVERVIEW



Technical data overview		
Functional principle	Edge detection, proximity and reflector / Edge detection, reflector	Diameter detection, proximity and reflector
Sensing distance	25 mm / 100 mm	25 mm / 100 mm
Measurement range	20 mm / 30 mm	20 mm / 30 mm
Repeatability	0.03 mm	0.03 mm
	0.05 mm	0.05 mm
MDO	0.8 mm	0.8 mm
	1.6 mm	1.6 mm
Analog output $Q_A$	4 mA ... 20 mA	4 mA ... 20 mA
Output type	PNP / NPN	PNP / NPN

At a glance		
	<ul style="list-style-type: none"> <li>• Detect position of edge of material</li> <li>• Reflector mode version also available</li> <li>• Compact, metal housing</li> <li>• Reproducibility of 0.03 mm</li> <li>• Sensing distance 25 mm or 100 mm</li> <li>• Measurement range up to 30 mm</li> <li>• Analog output 4 mA ... 20 mA</li> </ul>	<ul style="list-style-type: none"> <li>• Detection of diameter and width</li> <li>• Compact, metal housing</li> <li>• Reproducibility of 0.03 mm</li> <li>• Sensing distance 25 mm or 100 mm</li> <li>• Measurement range up to 30 mm</li> <li>• Analog output 4 mA ... 20 mA</li> </ul>

Further information		
Functional principle	<div style="display: flex; justify-content: space-around;"> <div style="text-align: center;"> <p>AT20E Proximity</p> </div> <div style="text-align: center;"> <p>AT20E/AL20E Reflector</p> </div> </div>	<div style="text-align: center;"> <p>AT20D</p> </div>
Analog output	<div style="display: flex; flex-wrap: wrap;"> <div style="width: 33%;"> <p>1. 20 mA</p> </div> <div style="width: 33%;"> <p>2. 12 mA</p> </div> <div style="width: 33%;"> <p>3. 4 mA</p> </div> <div style="width: 33%;"> <p>4. 20.5 mA</p> <p>Edge running on sensor head</p> </div> <div style="width: 33%;"> <p>5. 3.5 mA</p> <p>Edge running on connector side</p> </div> <div style="width: 33%;"> <p>6. 3 mA</p> <p>Web broken / edge out of visible range</p> </div> </div>	<div style="display: flex; justify-content: space-around;"> <div style="text-align: center;"> <p>4 mA</p> </div> <div style="text-align: center;"> <p>20 mA</p> </div> </div>
Fields of application	<ul style="list-style-type: none"> <li>• Measurement web edge guidance control, e.g., paper webs, foil and transparent materials</li> <li>• Object positioning (end of travel indication)</li> <li>• Line tracking</li> </ul>	<ul style="list-style-type: none"> <li>• Gap detection</li> <li>• Width measurement</li> <li>• Line diameter detection</li> </ul>
Detailed information	→ H-218	→ H-218

H

# AX20 ARRAY SENSORS FOR EDGE AND DIAMETER DETECTION SOLUTIONS

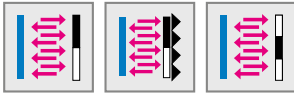

## Product description

Array sensors use closely spaced beams of light to detect even the slightest differences in gray scale between the target and the background within their field-of-view. They are ideal for edge and diameter detection as well as detecting

widths and gaps. SICK's array sensors offer industry-leading reproducibility, in addition to compact, rugged metal housings for use in highly restricted or harsh environments.

## At a glance

- Proximity contrast line sensor in a compact housing
- Application-specific sensor functions
- Detect position of edge of material
- Diameter, width and gap detection of different objects
- Very high reproducibility of 0.03 mm
- Large measurement range: 30 mm
- Visible white LED light spot to enable accurate alignment
- Simple setup, no teach-in necessary

## Your benefits

- Cost-effective solution to reliably determine edge position and width measurement
- Easy-to-integrate, compact housing can be mounted over the web so less downtime is required for maintenance
- No reflector is required, reducing maintenance and providing greater product reliability. Reduces downtime. Only array sensors available in diffuse mode, making them ideal for environments where dirt and dust can interfere with other types of solutions that require a reflector.
- High reproducibility of 0.03 mm and industry-leading resolution enable greater accuracy and quality control
- Highly visible white LED light spot ensures fast and accurate alignment, reducing time-consuming fine adjustment
- No teach, program or menu activities make setup virtually hassle free

H



## Additional information

- Detailed technical data . . . . . H-219
- Ordering information . . . . . H-220
- Dimensional drawing . . . . . H-221
- Connection diagram . . . . . H-221
- Setting the switching threshold . H-221
- Recommended accessories . . . H-222

→ [www.sick.com/de/en/Ax20](http://www.sick.com/de/en/Ax20)

For more information, just enter the link or scan the QR code and get direct access to technical data, CAD design models, operating instructions, software, application examples and much more.



## Detailed technical data

## Features

Dimensions (W x H x D)	24.3 mm x 59.8 mm x 54.1 mm
Sensing distance	25 mm / 100 mm (depending on type)
Housing design (light emission)	Rectangular
Operating range	20 mm, 30 mm / 90 mm, 110 mm (depending on type)
Measurement range	20 mm / 30 mm (depending on type)
Minimum detectable object (MDO)	0.8 mm / 1.6 mm (depending on type)
Light source	LED
Type of light	Visible white light
Wave length	400 nm ... 700 nm
Repeatability	0.03 mm <sup>1)</sup> / 0.05 mm <sup>1)</sup> (depending on type)
Linearity <sup>2)</sup>	± 2 %

<sup>1)</sup> With respect to sensing distance.

<sup>2)</sup> Analog current range (16 mA)

## Mechanics/electronics

Supply voltage <sup>1)</sup>	≤ 24 V DC
Ripple <sup>2)</sup>	≤ 5 V
Power consumption <sup>3)</sup>	< 3.1 W
Output type	PNP: HIGH = $V_S - \leq 2 \text{ V}$ / LOW approx. 0 V / NPN: HIGH = approx. $V_S$ / LOW ≤ 2 V (depending on type)
Output type	PNP <sup>4)</sup> / NPN <sup>4)</sup> (depending on type)
Analog output $Q_A$	4 mA ... 20 mA
Resolution of analog output	12 bit
Output rate of analog output	1 ms
Output current $I_{\text{max}}$	< 100 mA
Initialization time <sup>5)</sup>	0.48 s
Connection type	Connector M12, 5-pin
Protection class	III
Circuit protection	$V_S$ connections reverse-polarity protected, Output Q short-circuit protected, Interference suppression
Enclosure rating	IP 67
Weight	135 g
Housing material	Metal

<sup>1)</sup> ± 20 %. Operation in short-circuit protected network max. 8 A.

<sup>2)</sup> May not exceed or fall below  $U_v$  tolerances.

<sup>3)</sup> Without load.

<sup>4)</sup> Active when object detected.

<sup>5)</sup> Typ. max. 1.6 s.

## Ambient data

Ambient operating temperature	-10 °C ... +55 °C
Ambient storage temperature	-25 °C ... +75 °C
Shock load	According to IEC 60068
UL File No.	NRKH.E181493 & NRKH7.E181493

## Ordering information

Other models → [www.sick.com/de/en/Ax20](http://www.sick.com/de/en/Ax20)

### AT20E

- **Functional principle:** Edge detection
- **Operation mode:** Proximity and reflector

Sensing distance	Measurement range	Repeatability <sup>1)</sup>	MDO	Output type <sup>2)</sup>	Type	Part no.
25 mm	20 mm	0.03 mm	0.8 mm	PNP	AT20E-PM111	1044484
				NPN	AT20E-NM111	1046458
100 mm	30 mm	0.05 mm	1.6 mm	PNP	AT20E-PM331	1045990
				NPN	AT20E-NM331	1046459

<sup>1)</sup> With respect to sensing distance.

<sup>2)</sup> Active when object detected.

### AL20E

- **Functional principle:** Edge detection
- **Operation mode:** Reflector

Sensing distance	Measurement range	Repeatability <sup>1)</sup>	MDO	Output type <sup>2)</sup>	Type	Part no.
25 mm	20 mm	0.03 mm	0.8 mm	PNP	AL20E-PM111	1046463
				NPN	AL20E-NM111	1046460
100 mm	30 mm	0.05 mm	1.6 mm	PNP	AL20E-PM331	1046462
				NPN	AL20E-NM331	1046461

<sup>1)</sup> With respect to sensing distance.

<sup>2)</sup> Active when object detected.

### AT20D

- **Functional principle:** Diameter detection
- **Operation mode:** Proximity and reflector

Sensing distance	Measurement range	Repeatability <sup>1)</sup>	MDO	Output type <sup>2)</sup>	Type	Part no.
25 mm	20 mm	0.03 mm	0.8 mm	PNP	AT20D-PM111	1046464
				NPN	AT20D-NM111	1046466
100 mm	30 mm	0.05 mm	1.6 mm	PNP	AT20D-PM331	1046465
				NPN	AT20D-NM331	1046467

<sup>1)</sup> With respect to sensing distance.

<sup>2)</sup> Active when object detected.



Dimensional drawing (Dimensions in mm (inch))

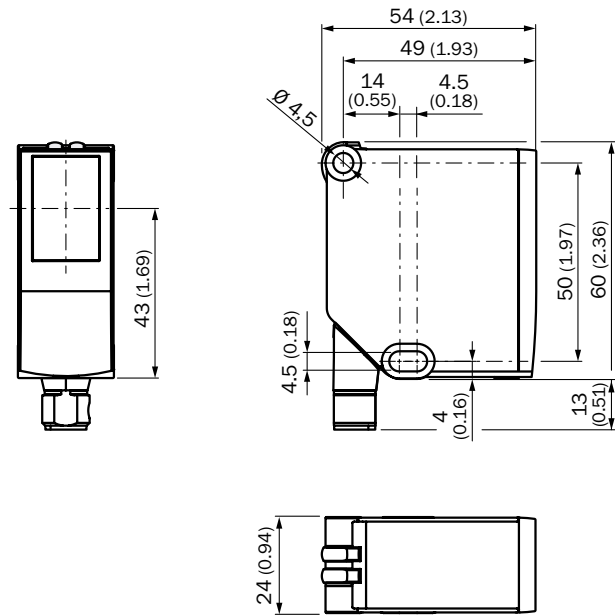

Connection diagram

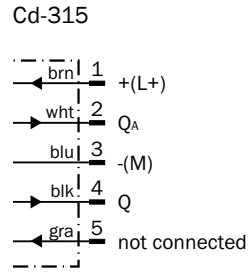

Setting the switching threshold

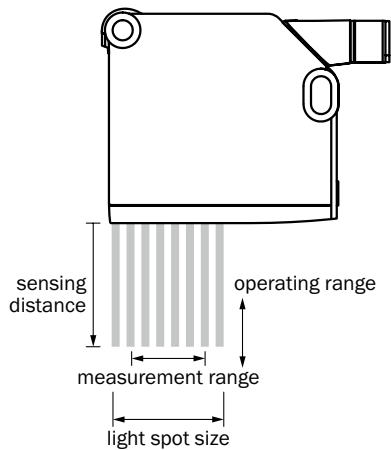

Sensing distance	Operating range	Measurement range	Light spot size
25 mm	20 mm ... 30 mm	20 mm	30 mm x 5 mm
100 mm	90 mm ... 110 mm	30 mm	50 mm x 10 mm

H

Recommended accessories

Mounting brackets and mounting plates

Mounting brackets

Figure	Description	Type	Part no.
	Mounting bracket, stainless steel (1.4404), without mounting material, for DT20 Hi	BEF-WN-DT20	4043524

Reflectors

Description	Type	Part no.
Glass covered reflector, 70 mm x 16 mm, reflective area: 40 mm x 10 mm	REF-AX-007	2080183



Reflective tape

Description	Type	Part no.
IRF 2000 reflective tape, 95 mm x 30 mm x 0.3 mm, without polarization effect	REF-AX-002	2049249
IRF 2000 reflective tape, 110 mm x 30 mm x 0.15 mm, without polarization effect	REF-AX-001	2049250
IRF 2000 reflective tape, 220 mm x 10 mm x 0.3 mm, without polarization effect	REF-AX-004	2062695
IRF 2000 reflective tape, 220 mm x 50 mm x 0.3 mm, without polarization effect	REF-AX-005	2069161

Plug connectors and cables

Connecting cables with female connector

M12, 5-pin, PVC, chemical resistant

Figure	Connection type head A	Connection type head B	Connecting cable	Type	Part no.
	Female connector, M12, 5-pin, straight, unshielded	Cable, open conductor heads	2 m, 5-wire	DOL-1205-G02M	6008899
			5 m, 5-wire	DOL-1205-G05M	6009868
			10 m, 5-wire	DOL-1205-G10M	6010544
	Female connector, M12, 5-pin, angled, unshielded	Cable, open conductor heads	2 m, 5-wire	DOL-1205-W02M	6008900
			5 m, 5-wire	DOL-1205-W05M	6009869
			10 m, 5-wire	DOL-1205-W10M	6010542

→ For additional accessories, please see page K-240







## MARKLESS SENSORS



### Running markless for stability and design freedom

The markless sensor is based on a pattern recognition principle. A taught-in image is used as a reference for the detection of a recurring contrast pattern. A stable switching signal is generated at high speed thanks to new technology without print marks. The markless sensor is ideal for applications in the packaging industry. User-friendly configuration is offered via the sensor's control panel or by using SICK's SOPAS software via Ethernet.

#### Your benefits

- Reliable detection, even with complex images reduces system downtime and waste
- Fewer machine builder restrictions mean more freedom when designing packaging
- Allows for more efficient utilization of space on the product instead of using unnecessary print marks and place markers
- Faster and easier format change by teaching of saved formats via Ethernet
- Monitor process and teach quality via a display or SOPAS, increasing reliability
- Fast and simple sensor alignment via a visible light spot and notches on the housing
- Easy sensor teach-in, directly via the control panel, external teach-in signal or using SOPAS via Ethernet





General information . . . . .	I-226
Product family overview . . . . .	I-231



<b>ML20 . . . . .</b>	<b>I-232</b>
Running markless for stability and design freedom	

# RUNNING MARKLESS FOR STABILITY AND DESIGN FREEDOM

Fewer marks – more design freedom! If SICK markless sensors could demonstrate, this is what their placards would say. With innovative technology and a whole new level of flexibility regarding the contrast patterns to be used, they are paving the way to a design-friendly future.

SICK markless sensors are particularly strong when it comes to rotary labeling: for example, when controlling the cutting process to isolate labels without the need for space-consuming

and unattractive print marks. Further advantages over sensors from other manufacturers include less machine downtime and less waste due to incorrect cutting.



## MORE DESIGN FREEDOM ACROSS THE ENTIRE FORMAT

No more playing hide and seek with marks on banderoles. The ML20 markless sensor gives a whole new meaning to “freedom from marks”. With the ML20, the need for print marks on beverage banderoles and packages for process control is a thing of the past.

### Banderole currently used with contrast mark



### New banderole without mark and with complete design freedom across the entire area



#### Your benefits

- Entire label can be used for advertising information
- No need to cover the contrast mark through material overlapping
- Low costs due to less material used
- No erroneous switching due to contrasts similar to marks

## TECHNOLOGY

The principle of operation for the markless sensors is based on a line sensor, which continuously searches for contrast differences in the available print image. This allows an exact switching point to be determined, even at high speeds.



Image captured from the perspective of the ML20

### Teach-in and configuration

Up to now, the position and mark were crucial for the correct teach-in of a sensor. With markless sensors, this is no longer necessary. Teaching-in new formats is extremely simple. With the ML20 markless sensor, formats already taught can be

saved via the SOPAS software and Ethernet UDP and reloaded to the sensor upon reuse. This reduces system and machine downtimes.

Start teach-in

Stop teach-in



Sensor field of view 34 mm

The red lines show the start and end points of an ideal teach-in procedure. Its starting position is then the switching point position.

The red circles identify the potential reference areas searched by the sensor when trying to detect the pattern.

## AN INNOVATIVE SOLUTION TO REQUIREMENTS

The innovative ML20 combines the flexibility of a vision sensor with precise mark detection in one housing. The use of a line allows quick and precise switching to repeating contrast patterns in a large field of view. Once again, SICK has succeeded in combining experience and expertise in tried-and-tested technologies and presenting the market with a pioneering sensor.

### MARKLESS SENSOR\*

- Speed of up to max. 7 m/s
- Simple teach-in through automatic selection of contrast areas in the overall image
- Accuracy of up to 0.6 mm

\* An encoder or motor feedback system is required for operation.

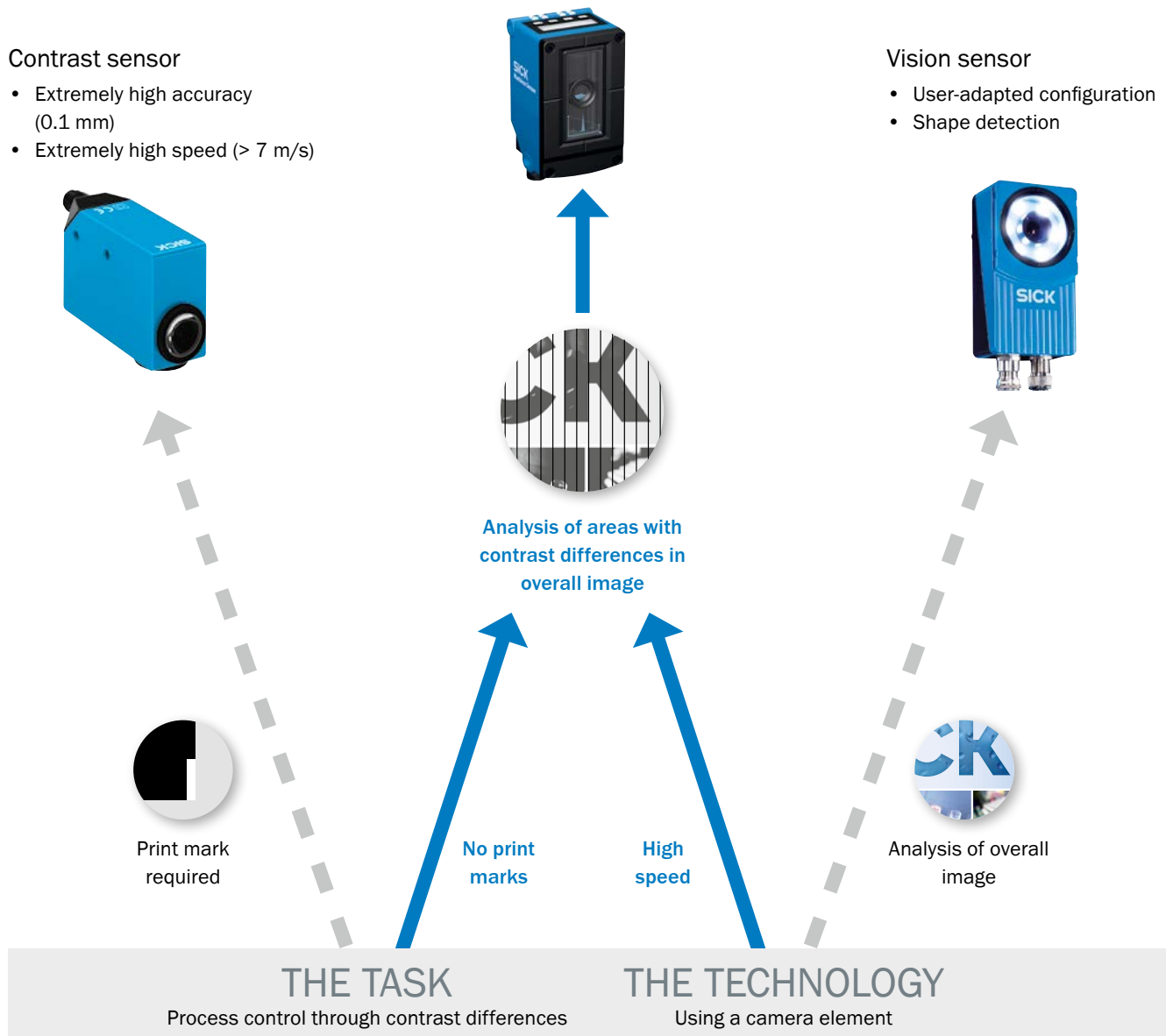



# PRODUCT FAMILY OVERVIEW



**ML20**

Running markless for stability and design freedom

### Technical data overview

Max. movement speed	7 m/s / 3.5 m/s (selectable)
Sensing distance	20 mm
Repeatability	0.6 mm / 0.3 mm (selectable)
Output type	PNP

### At a glance

- Tough metal housing
- Scanning speed of 7 m/s
- Monitor process quality via a control panel or SOPAS, via Ethernet
- Easy sensor teach-in and alignment
- Reproducibility up to 0.3 mm (2 Sigma)
- Plug can be rotated 90°

### Detailed information

→ I-232



# RUNNING MARKLESS FOR STABILITY AND DESIGN FREEDOM



## Product description

The markless sensor is based on a pattern recognition principle. A taught-in image is used as a reference for the detection of a recurring contrast pattern. A stable switching signal is generated at high speed thanks to new

technology without print marks. The markless sensor is ideal for applications in the packaging industry. User-friendly configuration is offered via the sensor's control panel or by using SICK's SOPAS software via Ethernet.

## At a glance

- Tough metal housing
- Scanning speed of 7 m/s
- Monitor process quality via a control panel or SOPAS, via Ethernet
- Easy sensor teach-in and alignment
- Reproducibility up to 0.3 mm (2 Sigma)
- Plug can be rotated 90°

## Your benefits

- Reliable detection, even with complex images reduces system downtime and waste
- More freedom when designing packaging
- Allows for more efficient utilization of space on the product instead of using unnecessary print marks and place markers
- Faster and easier format change by teaching of saved formats via Ethernet
- Monitor process and teach quality via a display or SOPAS, increasing reliability
- Fast and simple sensor alignment via a visible light spot and notches on the housing
- Easy sensor teach-in, directly via the control panel, external teach-in signal or using SOPAS via Ethernet



## Additional information

Detailed technical data . . . . . I-233  
 Ordering information . . . . . I-234  
 Dimensional drawing . . . . . I-234  
 Connection diagram . . . . . I-235  
 Recommended accessories . . . . I-235

→ [www.sick.com/de/en/ML20](http://www.sick.com/de/en/ML20)

For more information, just enter the link or scan the QR code and get direct access to technical data, CAD design models, operating instructions, software, application examples and much more.





## Detailed technical data

## Features

Dimensions (W x H x D)	46 mm x 77 mm x 46 mm
Sensing distance	20 mm
Housing design (light emission)	Rectangular
Sensing distance tolerance	± 2.5 mm
Light source <sup>1)</sup>	LED
Type of light	Visible white light
Wave length	400 nm ... 700 nm
Repeatability <sup>2)</sup>	0.6 mm (7 m/s) / 0.3 mm (3.5 m/s)
Max. movement speed	7 m/s
Teach-in mode	Start stop teach, trigger teach
Picture length (min.)	≥ 40 mm
Picture length (max.)	≤ 1,000 mm
Picture height (min.)	≥ 34 mm
Tolerance lateral movement	± 5 mm

<sup>1)</sup> Average service life: 100,000 h at  $T_U = +25$  °C.

<sup>2)</sup> Statistical error 2  $\sigma$ .

## Mechanics/electronics

Supply voltage <sup>1)</sup>	12 V DC ... 30 V DC
Ripple <sup>2)</sup>	≤ 5 V <sub>pp</sub>
Power consumption <sup>3)</sup>	< 6 W
Output type	PNP: HIGH = $V_S - \leq 2$ V / LOW < 0,5 V
Status output <sup>4)</sup>	PNP: HIGH = $V_S - \leq 2$ V / LOW < 0,5 V
Output type	PNP
Output current I <sub>max.</sub> <sup>5)</sup>	< 100 mA
Input, teach-in (ET)	PNP: Teach: U = 12 V ... < U <sub>v</sub> , Run: U < 2 V
Input, blanking input (AT) <sup>6)</sup>	PNP: blanked: U = 12 V ... < U <sub>v</sub> , free-running U < 2 V
Initialization time	< 10 s
Retention time (ET)	≥ 6 s, non-volatile memory
Connection type	Connector M12, 12-pin / Connector M12, 4-pin
Ambient light safety	30,000 lx
Protection class	III
Circuit protection	V <sub>S</sub> connections reverse-polarity protected, Output Q short-circuit protected, Interference suppression
Fieldbus interface	EtherNet/IP
Enclosure rating	IP 65
Weight	325 g
Housing material	Metal
Encoder resolution	100 $\mu$ m ... 400 $\mu$ m (in 1 $\mu$ m)
Encoder input	Differentiel: 4,5 V - 5,5 V / TTL / RS-422, single ended: 12 V - 30 V / HTL / push-pull

<sup>1)</sup> Limit values; operation in short-circuit protected network max. 8 A.

<sup>2)</sup> May not exceed or fall below U<sub>v</sub> tolerances.

<sup>3)</sup> Without load.

<sup>4)</sup> Detailed description of the status output in operating manual.

<sup>5)</sup> Sum I<sub>out</sub> = Q + Q status.

<sup>6)</sup> Fade-out of identical areas.

Ambient data

Ambient operating temperature	-10 °C ... +55 °C
Ambient storage temperature	-20 °C ... +75 °C
Shock load	According to IEC 60068
UL File No.	NRKH.E181493 & NRKH7.E181493

Ordering information

Other models → [www.sick.com/de/en/ML20](http://www.sick.com/de/en/ML20)

- **Data interface:** Ethernet TCP/IP

Light source <sup>1)</sup>	Max. movement speed	Sensing distance	Repeatability <sup>2)</sup>	Output type	Type	Part no.
LED	7 m/s / 3.5 m/s	20 mm	0.6 mm (7 m/s) / 0.3 mm (3.5 m/s)	PNP	ML20M-P1211	1044675

<sup>1)</sup> Average service life: 100,000 h at T<sub>U</sub> = +25 °C.

<sup>2)</sup> Statistical error 2 σ.

Dimensional drawing (Dimensions in mm (inch))

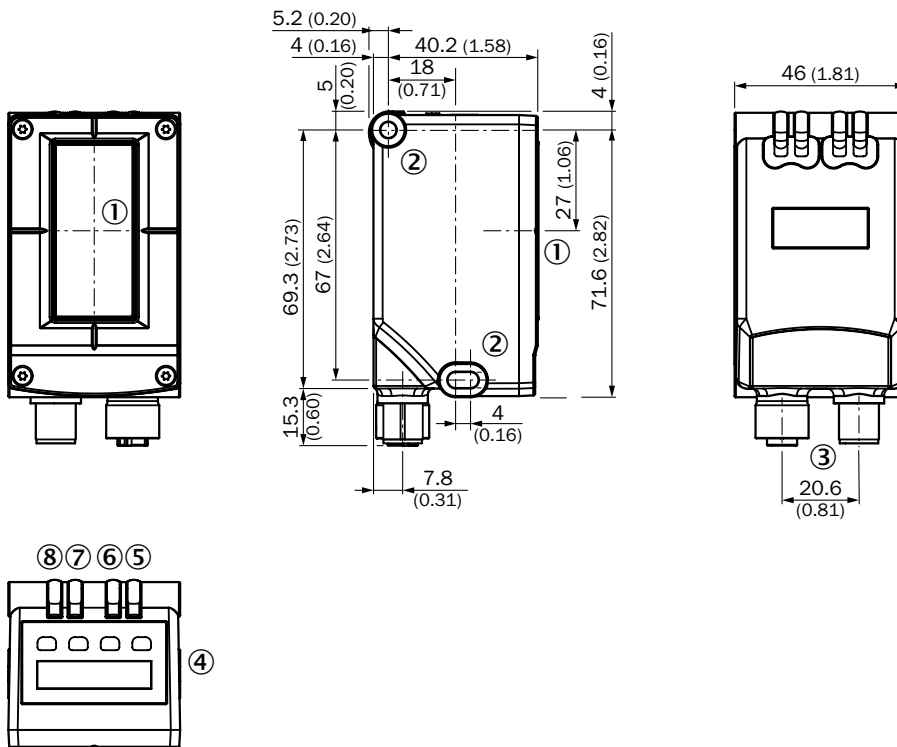

- ① Center of optical axis
- ② Mounting hole, Ø 4.2 mm
- ③ Connector M12, 12-pin/Connector M12, 4-pin, rotatable up to 90° (Ethernet)
- ④ Display and function buttons
- ⑤ Function signal indicator (green) "on"
- ⑥ Function signal indicator (yellow) "Q"
- ⑦ Function signal indicator (green) "Link"
- ⑧ Function signal indicator (yellow) "Act"

## Connection diagram

Cd-320

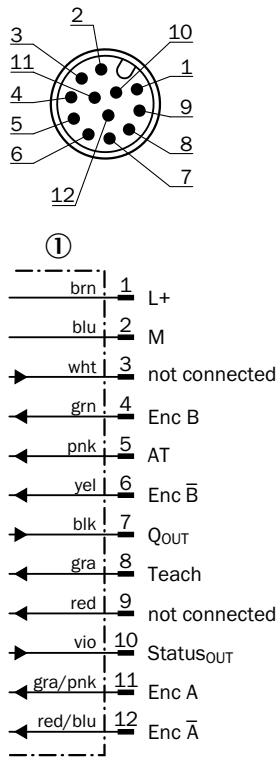

M12 (A-coded)

① Connection diagram M12, 12-pin

Cd-319

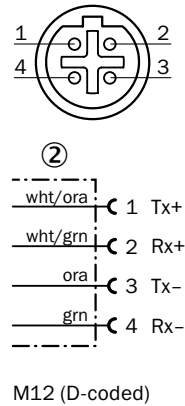

M12 (D-coded)

② Connection diagram M12, 4-pin

## Recommended accessories

### Universal bar clamp systems

Figure	Material	Description	Type	Part no.
	Zinc plated steel (sheet), Diecast zinc (clamp)	Plate N04 for universal clamp bracket, steel	BEF-KHS-N04	2051610
	Steel, zinc coated	Mounting bar, straight, 200 mm, steel	BEF-MS12G-A	4056054
		Mounting bar, L-shaped, 250 x 250 mm, steel	BEF-MS12L-B	4056053

### Plug connectors and cables

#### Connecting cables with female connector

M12, 12-pin, PVC

Figure	Connection type head A	Connection type head B	Connecting cable	Type	Part no.
	Female connector, M12, 12-pin, angled, shielded	Cable, open conductor heads	5 m, 12-wire	DOL1212- W05MAS02	6044109
	Female connector, M12, 12-pin, straight, shielded	Cable, open conductor heads	5 m, 12-wire, twisted pair	DOL1212- G05MAS02	6042754



Connection cables with female connector and male connector

M12, 12-pin, PVC

Figure	Connection type head A	Connection type head B	Connecting cable	Type	Part no.
	Female connector, M12, 12-pin, straight, shielded	Male connector, M12, 12-pin, straight	5 m, 12-wire, twisted pair	DSL-1212-G05MAS02	6045234

Connection cables with male connector and male connector

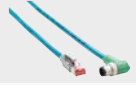
M12, 4-pin, Ethernet

Figure	Connection type head A	Connection type head B	Connecting cable	Type	Part no.
	Male connector, M12, 4-pin, angled, D-coded, shielded	Male connector, RJ45, 8-pin, straight	5 m	Connection cable (male connector-male connector)	6039488
	Male connector, M12, 4-pin, straight, D-coded, shielded	Male connector, RJ45, 8-pin, straight	5 m, 4-wire, AWG26	SSL-2J04-G05ME	6034415

→ For additional accessories, please see page K-240



## STANDARD FUNCTIONS WITH IO-LINK

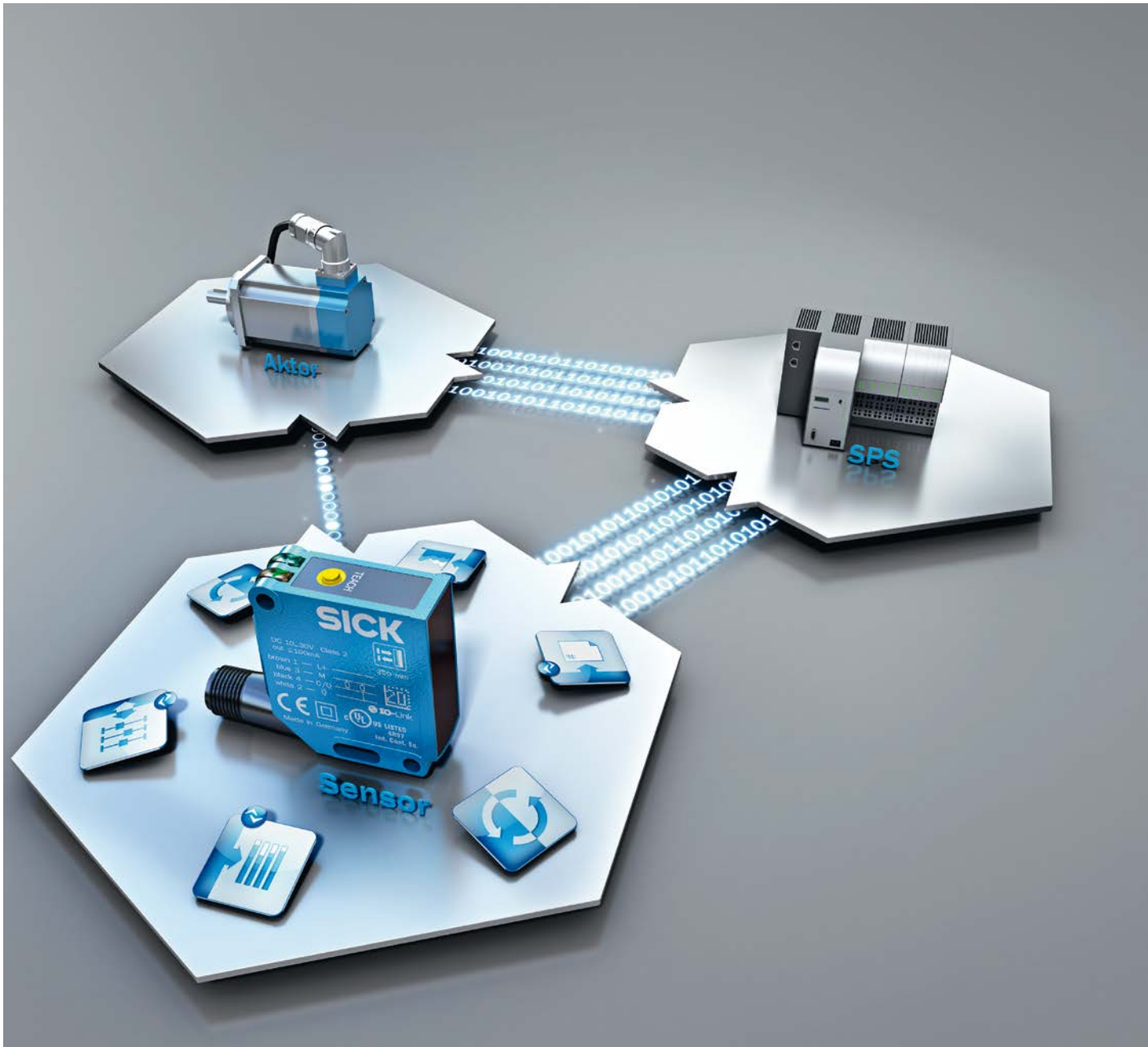

SICK sensors with IO-Link functions that can be integrated into an automation system offer a whole host of useful functions, from configuration and operation all the way through to monitoring. Even the standard functions go far beyond the scope of straightforward binary 0/1 switching signals.

## OPTIMIZED AUTOMATION FOR MACHINES AND SYSTEMS



### Condition monitoring / diagnostics

Implementing diagnostics and self-test options enables features such as contamination evaluation for sensors. Thanks to the monitoring capabilities of the sensors, preventive maintenance can be carried out using a precise maintenance plan. This ability to predict machine status even extends across area boundaries. The advantages of this are reduced maintenance and repair times, minimal risk of failure, as well as accurate fault localization and diagnostics.



### E-parts list / E-inventory

IO-Link enables the electronic documentation for all sensors in the machine or system's as-delivered state to be created quickly and using an automated method. The advantages of this are increased transparency in the electronic documentation for installed sensors, cables, and male connectors. This prevents time-consuming troubleshooting processes that result from different versions of documentation. What is more, the machine or system's as-delivered state can be documented easily and accurately in this way.



### Sensor visualization

Sensor data such as the device ID, serial number, teach-in values, hysteresis or switching behavior can be displayed and modified using visualization software and the SiLink Box on a PC. All parameters can be optimized and transferred to multiple sensors.

The advantages of this are:

- Comprehensive diagnostics options
- Availability values can be checked and parameters can be optimized
- Simplified range of function and performance options available for selection
- Quick and safe sensor pre-configuration
- Easy identification of optimized application parameters
- Simple commissioning



### Flexible sensor adjustment

An IO-Link sensor receives optimized, application-specific parameters (such as the sensing distance, hysteresis or threshold) from the automation system according to the production process or the product that is to be produced. The advantages of this are reduced machine downtimes and changeover times when switching products, more machine flexibility, and the prevention of incorrect settings.



### Easy device replacement

Sensors with IO-Link can be replaced quickly and easily, as they are able to adopt the set function parameters without any alterations. The parameters are stored in the IO-Link master or in the control system. The advantages of this are minimal downtimes, guaranteed machine availability, as well as recorded and documented replacement processes.

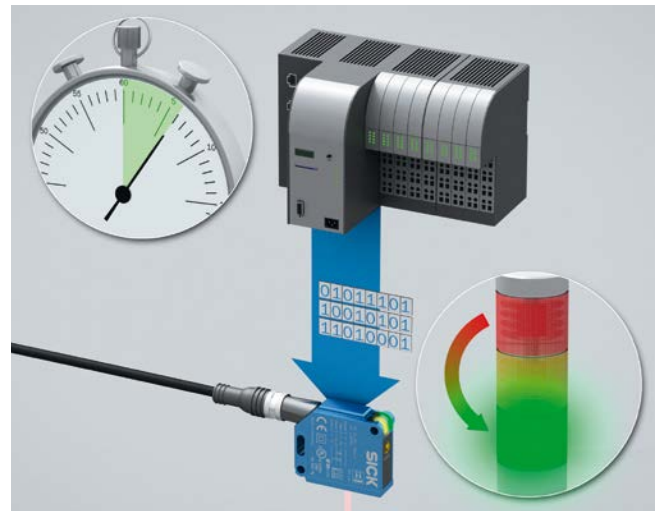



## ACCESSORIES



### Perfect sensor integration made easy

Innovative sensor technology is only one side of the coin when talking about intelligent automation solutions. The picture is completed by matching accessories for professional and cost-effective integration. Whether electrical connection technology or mechanical mounting systems, only the right integrative system products lead to a high quality,

highly available application solution. The advantage? Sensors and accessories work in conjunction to offer maximum operational safety.

In addition, the user is able to save additional costs for development, manufacture and procurement. A wide range of accessory components are always available on short-notice – convenient

single-source availability in combination with sensors. And in the event that a custom solution is required, SICK is on your side as a reliable and competent partner. Tailored developments and adaptations can be implemented in just a short period of time.





**Mounting systems . . . . .K-244**



**Reflectors and optics. . . . .K-249**



**Connection systems . . . . .K-254**

## MOUNTING SYSTEMS AND CONNECTIVITY

### Mounting systems



To integrate SICK sensors perfectly into a machine or system, mounting equipment tailored precisely to the sensors is required. Whether fine adjustment to precision equipment or protection against harsh environmental conditions, SICK provides matching designs and products for mounting, alignment, and protection for its sensors. When it comes to special applications, SICK works with the customer to develop tailored and system-specific mounting elements, which are then delivered with the sensor.

### Your benefits

- Quick system installation and maintenance thanks to a broad portfolio of simple, practical mounting options tailored to SICK sensors
- Flexible, customized alignment of the sensor to the object being detected using the universal clamp system
- Prevention of sensor damage (e.g. due to mechanical loads) and guarantee of sensor functionality with the aid of SICK sensor protection solutions
- Application-specific solutions for mounting, aligning, and protecting sensors

## Passive connectivity



A broad portfolio of termination screw male and female connectors allows customized wiring solutions to be implemented. Depending on the requirements, SICK offers different lengths of cable and materials that are delivered quickly and pre-assembled free of errors. Connecting cables (with a molded round connector at one end and open at the other end) offer maximum flexibility when wiring sensors.

### Your benefits





- Operational safety because the connectivity is designed for the sensors
- Low costs thanks to high-quality components with long service lives
- Guaranteed productivity thanks to reliable detection
- Ready to assemble plug connectors with screw connection or insulation piercing
- Broad portfolio of connecting and extension cables with PUR jacket (high resistance to oils, lubricants, and coolants), PVC jacket (good resistance to chemicals for use in dry zones), and for use in hygienic and washdown zones (maximum resistance to chemicals, acids, alkalis, and cleaning agents)



Mounting systems

Mounting brackets and mounting plates

Mounting brackets

Figure	Material	Description	Type	Part no.	KTM Core	KTM Prime	KTM Prime Inox	KT3LLaser	CSM	LUTM	Ax20
	Stainless steel	Mounting bracket for wall mounting	BEF-W100-A	5311520	●	●	●	-	●	●	-
		Mounting bracket, stainless steel (1.4404), without mounting material	BEF-WN-DT20	4043524	-	-	-	-	-	-	●
	Steel, zinc coated	Mounting bracket for floor mounting	BEF-W100-B	5311521	●	●	●	-	●	●	-
			BEF-WN-W100-S01	4073866	●	●	●	-	●	●	-
		Mounting bracket	BEF-WN-W9-2	2022855	-	-	-	●	-	-	-

→ For dimensional drawings, please see page K-245

Mounting plates

Figure	Material	Description	Type	Part no.	KTM Core	KTM Prime	KTM Prime Inox	CSM	LUTM
	Stainless steel	Adapter plate KT3 to KTM	BEF-AP-KTMS01	2068786	●	●	●	●	●

→ For dimensional drawings, please see page K-245

Universal bar clamp systems







Figure	Material	Description	Type	Part no.
	Steel, zinc coated	Plate G for universal clamp bracket	BEF-KHS-G01	2022464
		Plate K for universal clamp bracket	BEF-KHS-K01	2022718
		Universal clamp bracket for rod mounting	BEF-KHS-KH1	2022726
		Plate L for universal clamp bracket	BEF-KHS-L01	2023057
	Zinc plated steel (sheet), Diecast zinc (clamp)	Plate N08 for universal clamp bracket	BEF-KHS-N08	2051607
		Plate N04 for universal clamp bracket, steel	BEF-KHS-N04	2051610

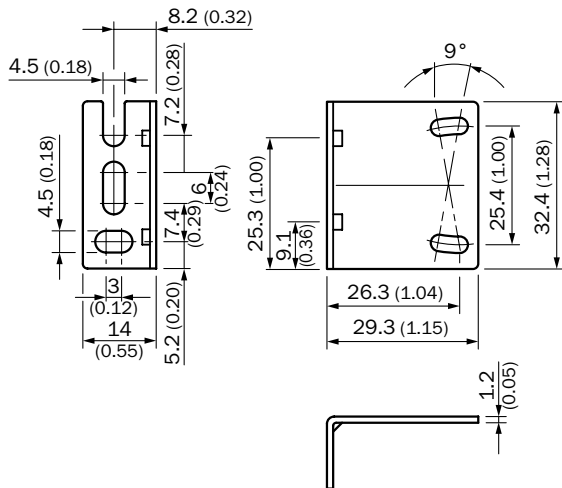

Figure	Material	Description	Type	Part no.
	Stainless steel 1.4571 (sheet), Stainless steel 1.4408 (clamp)	Plate N08N for universal clamp bracket	BEF-KHS-N08N	2051616
		Plate N04N for universal clamp bracket	BEF-KHS-N04N	2051620
		Plate N11N for universal clamp bracket	BEF-KHS-N11N	2071081
	Steel, zinc coated	Mounting bar, straight, 200 mm, steel	BEF-MS12G-A	4056054
		Mounting bar, straight, 300 mm, steel	BEF-MS12G-B	4056055
Mounting bar, straight		BEF-M12GF-A	2059414	
		Mounting bar, L-shaped, 150 mm x 150 mm, steel	BEF-MS12L-A	4056052
		Mounting bar, L-shaped, 250 x 250 mm, steel	BEF-MS12L-B	4056053
		Steel, zinc coated	Mounting bar, Z-shaped, 150 mm x 70 mm x 150 mm, steel	BEF-MS12Z-A
	Mounting bar, Z-shaped, 150 mm x 70 mm x 250 mm, steel		BEF-MS12Z-B	4056057
	Aluminum	Bar clamp for bar diameter of 12 mm (fixing the mounting rod)	BEF-RMC-D12	5321878

→ For dimensional drawings, please see page K-247

Dimensional drawings mounting systems

BEF-W100-A



BEF-WN-DT20

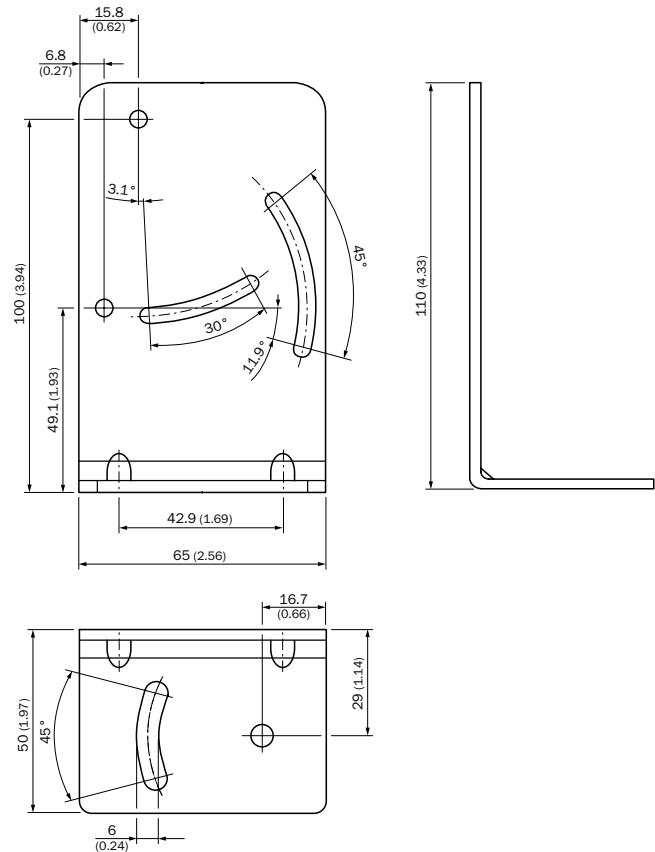

BEF-W100-B

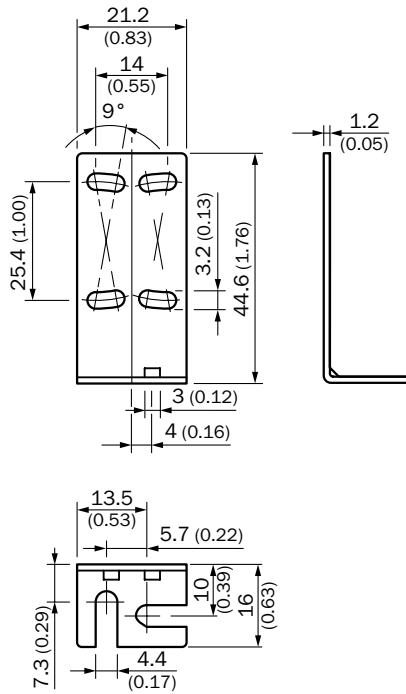

BEF-WN-W100-S01

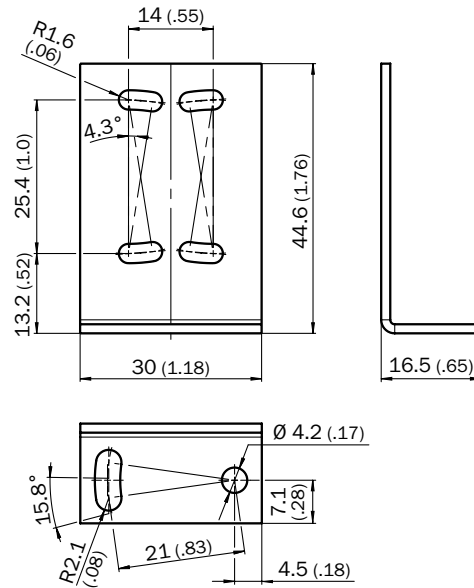

BEF-WN-W9-2

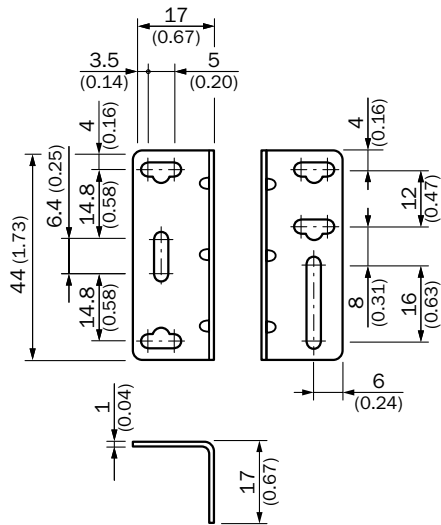

BEF-AP-KTMS01

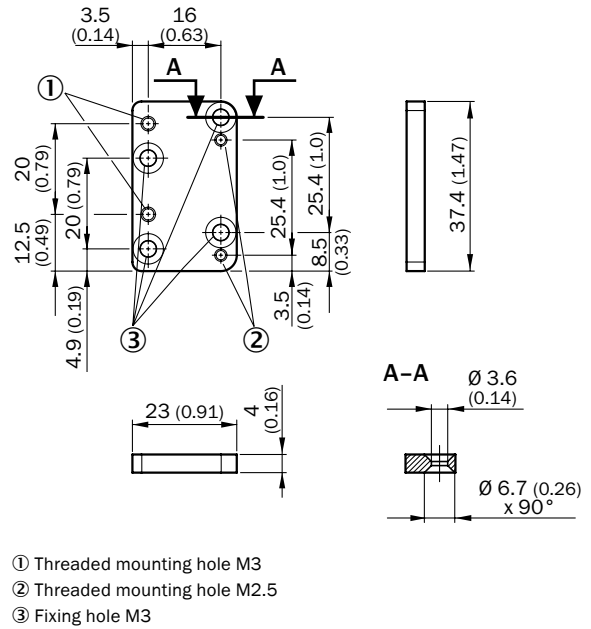

- ① Threaded mounting hole M3
- ② Threaded mounting hole M2.5
- ③ Fixing hole M3

Dimensional drawings universal bar clamp systems

BEF-KHS-G01

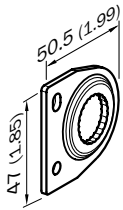

BEF-KHS-K01

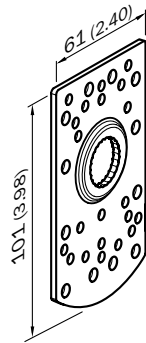

BEF-KHS-KH1

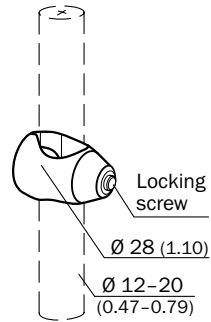

BEF-KHS-L01

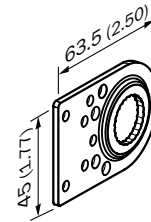

BEF-KHS-N04, BEF-KHS-N04N

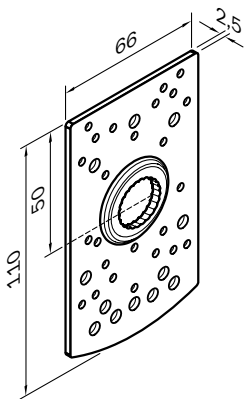

BEF-KHS-N11N

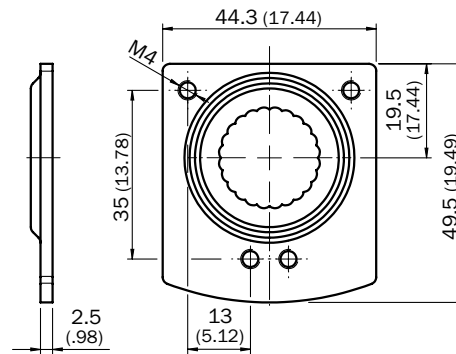

BEF-KHS-N08, BEF-KHS-N08N

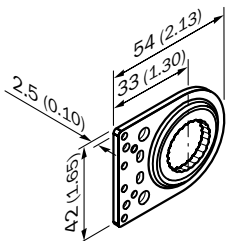

BEF-MS12G-A  
BEF-MS12G-B

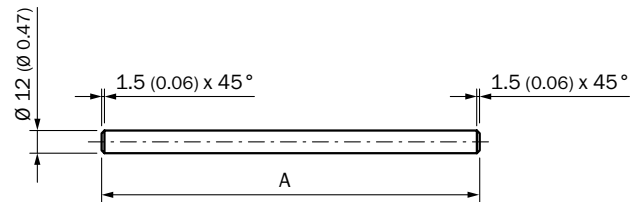

- ① BEF-MS12G-(N)A: A = 200 mm
- ② BEF-MS12G-(N)B: A = 300 mm

BEF-M12GF-A

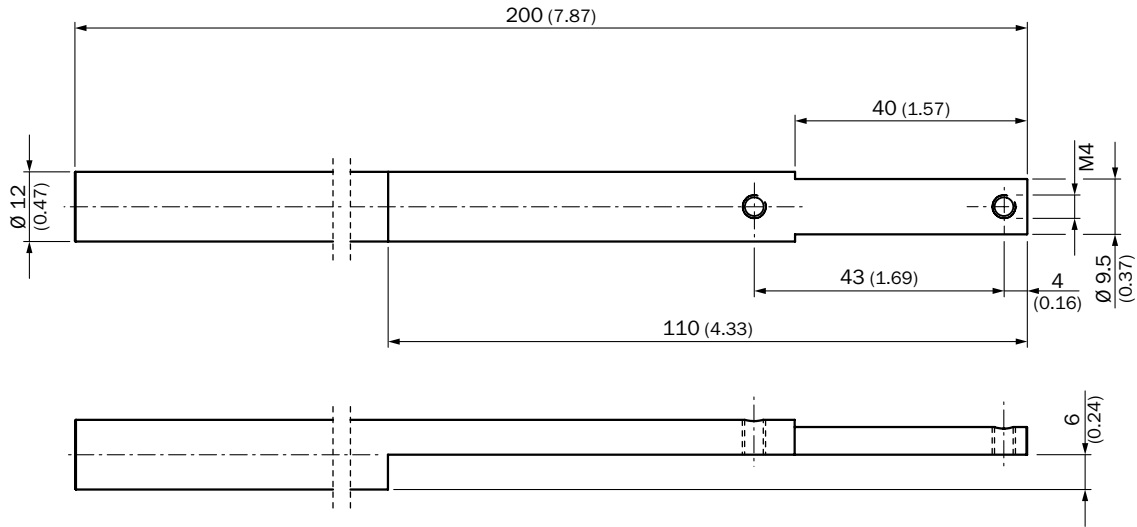

BEF-MS12L-A, BEF-MS12L-B

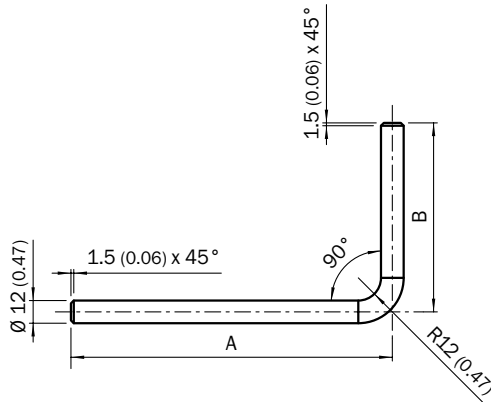

- ① BEF-MS12L-(N)A: A = 200 mm, B = 150 mm
- ② BEF-MS12L-(N)B: A = 250 mm, B = 250 mm

BEF-MS12Z-A, BEF-MS12Z-B

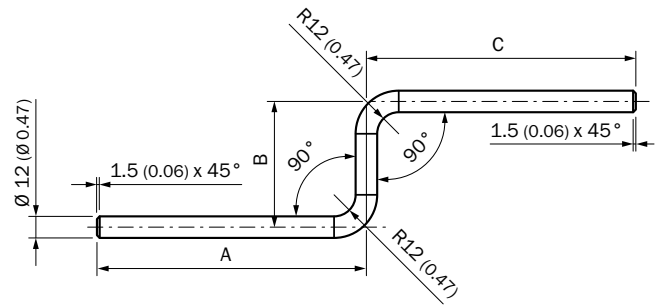

- ① BEF-MS12Z-(N)A: A = 150 mm, B = 70 mm, C = 150 mm
- ② BEF-MS12Z-(N)B: A = 150 mm, B = 70 mm, C = 250 mm

BEF-RMC-D12

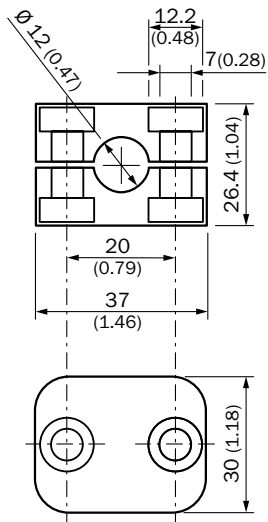



## Reflectors and optics

## Lens and accessories

Description	Diameter	Type	Part no.	KT5-2 Potentiometer	KT5-2 Teach-in	KT5-2 Display	LUT3-6	LUT8	LUT9
Lens, 40 mm sensing distance	26 mm	OBJ-210	2010945	●	●	●	-	-	-
Lens, 10 mm sensing distance	25.6 mm	OBJ-211	1004936	●	●	●	-	-	-
Lens, 20 mm sensing distance	25.6 mm	OBJ-212	1011506	●	●	●	-	-	-
Lens, 10 mm sensing distance	26 mm	OBJ-LUT3-10	2016348	-	-	-	●	●	●
Lens, 20 mm sensing distance	26 mm	OBJ-LUT3-20	2016349	-	-	-	●	●	●
Lens, 50 mm sensing distance	26 mm	OBJ-LUT3-50	2016350	-	-	-	●	●	●

→ For dimensional drawings, please see page K-251

## Reflectors and reflective tape

Figure	Description	Type	Part no.	Ax20E Edge	Ax20D Diameter
	IRF 2000 reflective tape, 110 mm x 30 mm x 0.3 mm, without polarization effect	REF-AX-001	2049250	●	●
	IRF 2000 reflective tape, 95 mm x 30 mm x 0.15 mm, without polarization effect	REF-AX-002	2049249	●	●
	IRF 2000 reflective tape, 220 mm x 10 mm x 0.3 mm, without polarization effect	REF-AX-004	2062695	●	●
	IRF 2000 reflective tape, 220 mm x 50 mm x 3 mm, without polarization effect	REF-AX-005	2069161	●	●
	Reflector with glass cover, 70 mm x 16 mm, reflective are: 40 mm x 10 mm	REF-AX-007	2080183	●	●

→ For dimensional drawings, please see page K-251

## Fibers

## Proximity system

- **Core material:** Glass fiber
- **Jacket material:** stainless steel
- **Ambient operating temperature:** -50 °C +250 °C

Mounting sleeve dimension	Dimensions end sleeve	Bend radius, fibre-optic cable	Type	Part no.	KTL5-2 Fiber Optic
5/16" x 24	5/16" x 24	19 mm	LBSAT32900	7020036	●
			LBST32900	7020046	●
	Ø 4,7 mm	19 mm	LBSTA32900	7020048	●
			LBSTA325000	7022348	●
Ø 6,4 mm	Ø 4,7 mm	19 mm	LBSAA23900	7020103	●
Ø 7,1 mm	Ø 4,7 mm	50 mm	LSSF32500	7122528	●
Ø 7,2 mm	Ø 1,6 mm	19 mm	LBSM12900	7020054	●

K

Mounting sleeve dimension	Dimensions end sleeve	Bend radius, fibre-optic cable	Type	Part no.	KTL5-2 Fiber Optic
Ø 7,4 mm	Ø 4,7 mm	19 mm	LBSA32900	7020040	●
			LBSF32900	7020038	●
Ø 7,7 mm	Ø 2,3 mm	19 mm	LBSP16900	7020044	●
25,4 mm x 19,5 mm x 6,4 mm	25,4 mm x 19,5 mm x 6,4 mm	19 mm	LBSR16900	7020050	●
25,4 mm x 19,3 mm x 6,4 mm	25,4 mm x 19,3 mm x 6,4 mm	19 mm	LBSR32900	7020042	●
38,1 mm x 50,8 mm x 9,4 mm	38,1 mm x 50,8 mm x 9,4 mm	19 mm	LBSR40900	7020052	●

Through-beam system

- **Core material:** Glass fiber
- **Jacket material:** stainless steel
- **Bend radius, fibre-optic cable:** 19 mm
- **Ambient operating temperature:** -50 °C +250 °C

Mounting sleeve dimension	Dimensions end sleeve	Type	Part no.	KTL5-2 Fiber Optic
Ø 6,4 mm	Ø 4,7 mm	LISAA23900	7020102	●
Ø 7,4 mm	Ø 4,7 mm	LISA32900	7020039	●
5/16" x 24	5/16" x 24	LISAT32900	7020035	●
Ø 7,4 mm	Ø 4,7 mm	LISF32900	7020037	●
Ø 7,2 mm	Ø 1,6 mm	LISM12900	7020053	●
Ø 7,7 mm	Ø 2,3 mm	LISP16900	7020043	●
25,4 mm x 19,5 mm x 6,4 mm	25,4 mm x 19,5 mm x 6,4 mm	LISR16900	7020049	●
25,4 mm x 19,3 mm x 6,4 mm	25,4 mm x 19,3 mm x 6,4 mm	LISR32900	7020041	●

→ For dimensional drawings, please see page K-252

Reference material

- **Core material:** Glass fiber
- **Jacket material:** stainless steel
- **Bend radius, fibre-optic cable:** 19 mm
- **Ambient operating temperature:** -50 °C +250 °C

Material	Description	Type	Part no.
Crayon	Crayon, red fluorescent	LUM-FT	1004460
Writing chalk	Writing chalk, red fluorescent	LUM-KLK	1002959



Dimensional drawings lens and accessories

OBJ-210

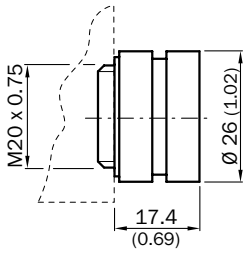

OBJ-211

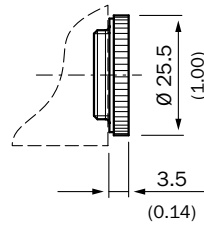

OBJ-212

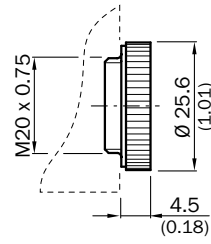

OBJ-LUT3-10

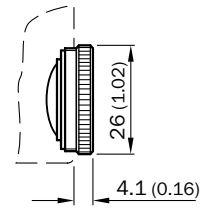

OBJ-LUT3-20, OBJ-LUT3-50

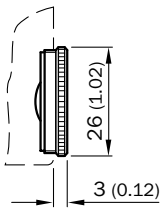

Dimensional drawings reflectors and reflective tape

REF-AX-001

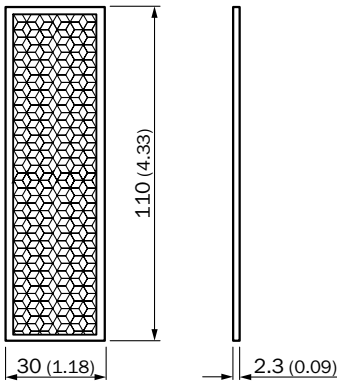

REF-AX-002

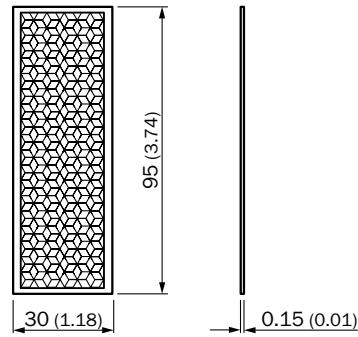

REF-AX-004

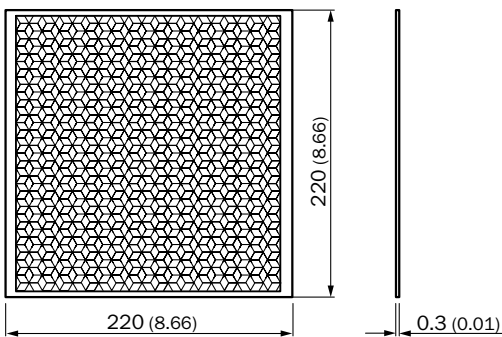

REF-AX-005

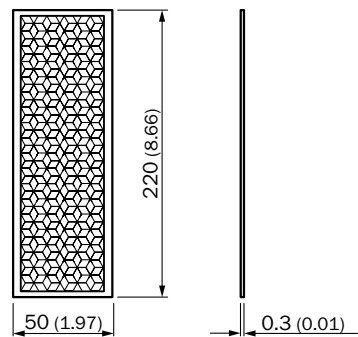



LISR16900, LBSR16900

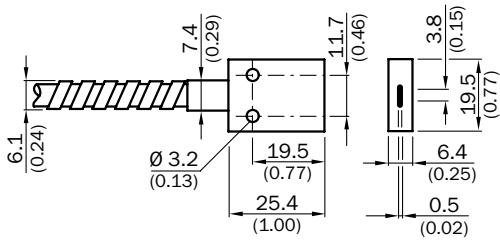

LISR32900, LBSR32900

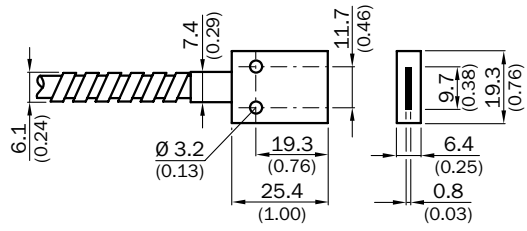

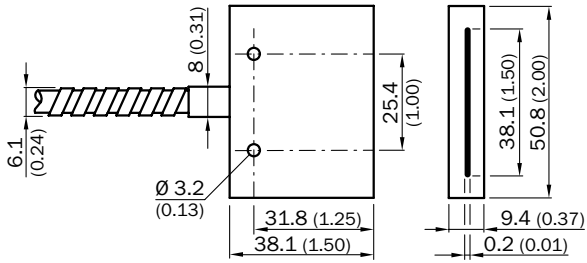

LISR40900, LBSR40900



Connection systems

Modules and gateways

Figure	Description	Type	Part no.						
				KTM Core	KTM Prime	CSM	LUTM	Glare	WFS
	IO-Link version V1.1, Port class 2, PIN 2, 4, 5 galvanically connected, Supply voltage 18 V DC ... 32 V DC (limit values, operation in short-circuit protected network max. 8 A)	SICK Memory Stick	1064290	●	●	●	●	●	●
	IO-Link V1.1 Class A port, USB2.0 port, optional external power supply 24V / 1A	SiLink2 Master	1061790	●	●	●	●	●	●



→ For dimensional drawings, please see page K-258

Plug connectors and cables

Connecting cables with female connector



M8, 3-pin, PUR, halogen-free, Oil / grease resistant

- **Cable material:** PUR, halogen-free
- **Connector material:** TPU
- **Locking nut material:** Zinc die-cast, nickel-plated

Figure	Connection type head A	Connection type head B	Connecting cable	Type	Part no.
	Female connector, M8, 3-pin, straight, unshielded	Cable, open conductor heads	1 m, 3-wire	DOL-0803-G01MC	6036455
			2 m, 3-wire	DOL-0803-G02MC	6025888
			3 m, 3-wire	DOL-0803-G03MC	6038991
			5 m, 3-wire	DOL-0803-G05MC	6025889
			10 m, 3-wire	DOL-0803-G10MC	6025890
			20 m, 3-wire	DOL-0803-G20MC	6036456
	Female connector, M8, 3-pin, angled, unshielded	Cable, open conductor heads	2 m, 3-wire	DOL-0803-W02MC	6025891
			5 m, 3-wire	DOL-0803-W05MC	6025892
			10 m, 3-wire	DOL-0803-W10MC	6025893

M8, 3-pin, PVC, chemical resistant



- **Cable material:** PVC, halogen-free
- **Connector material:** TPU
- **Locking nut material:** CuZn, nickel-plated

Figure	Connection type head A	Connection type head B	Connecting cable	Type	Part no.
	Female connector, M8, 3-pin, straight, unshielded	Cable, open conductor heads	2 m, 3-wire	DOL-0803-G02M	6010785
			5 m, 3-wire	DOL-0803-G05M	6022009
			10 m, 3-wire	DOL-0803-G10M	6022011
			15 m, 3-wire	DOL-0803-G15M	6036472
	Female connector, M8, 3-pin, angled, unshielded	Cable, open conductor heads	2 m, 3-wire	DOL-0803-W02M	6008489
			5 m, 3-wire	DOL-0803-W05M	6022010
			10 m, 3-wire	DOL-0803-W10M	6022012
			15 m, 3-wire	DOL-0803-W15M	6036473





M8, 4-pin, PUR, halogen-free, Oil / grease resistant

- **Cable material:** PUR, halogen-free
- **Connector material:** TPU
- **Locking nut material:** Zinc die-cast, nickel-plated

Figure	Connection type head A	Connection type head B	Connecting cable	Type	Part no.
	Female connector, M8, 4-pin, straight, unshielded	Cable, open conductor heads	2 m, 4-wire	DOL-0804-G02MC	6025894
			5 m, 4-wire	DOL-0804-G05MC	6025895
			10 m, 4-wire	DOL-0804-G10MC	6025896
			20 m, 4-wire	DOL-0804-G20MC	6051148
	Female connector, M8, 4-pin, straight, shielded	Cable, open conductor heads	5 m, 4-wire	DOL-0804-G05MAC	6050809
			10 m, 4-wire	DOL-0804-G10MAC	6050808
	Female connector, M8, 4-pin, angled, unshielded	Cable, open conductor heads	2 m, 4-wire	DOL-0804-W02MC	6025897
			5 m, 4-wire	DOL-0804-W05MC	6025898
			10 m, 4-wire	DOL-0804-W10MC	6025899



M8, 4-pin, PVC, chemical resistant

- **Cable material:** PVC, halogen-free
- **Connector material:** TPU
- **Locking nut material:** CuZn, nickel-plated

Figure	Connection type head A	Connection type head B	Connecting cable	Type	Part no.
	Female connector, M8, 4-pin, straight, unshielded	Cable, open conductor heads	1.5 m, 4-wire	DOL-0804-G1M5	6049343
			2 m, 4-wire	DOL-0804-G02M	6009870
			2.5 m, 4-wire	DOL-0804-G2M5	6049344
			3 m, 4-wire	DOL-0804-G03M	6049342
			5 m, 4-wire	DOL-0804-G05M	6009872
			10 m, 4-wire	DOL-0804-G10M	6010754
	Female connector, M8, 4-pin, angled, unshielded	Cable, open conductor heads	2 m, 4-wire	DOL-0804-W02M	6009871
			5 m, 4-wire	DOL-0804-W05M	6009873
			10 m, 4-wire	DOL-0804-W10M	6010755





M12, 4-pin, PUR, halogen-free, Oil / grease resistant

- **Cable material:** PUR, halogen-free
- **Connector material:** TPU
- **Locking nut material:** Zinc die-cast, nickel-plated

Figure	Connection type head A	Connection type head B	Connecting cable	Type	Part no.
	Female connector, M12, 4-pin, straight, unshielded	Cable, open conductor heads	2 m, 4-wire	DOL-1204-G02MC	6025900
			5 m, 4-wire	DOL-1204-G05MC	6025901
			10 m, 4-wire	DOL-1204-G10MC	6025902
			15 m, 4-wire	DOL-1204-G15MC	6034749
			20 m, 4-wire	DOL-1204-G20MC	6034750
			25 m, 4-wire	DOL-1204-G25MC	6034751
	Female connector, M12, 4-pin, straight, shielded	Cable, open conductor heads	10 m, 4-wire	DOL-1204-G10MAC	6041797
	Female connector, M12, 4-pin, angled, unshielded	Cable, open conductor heads	2 m, 4-wire	DOL-1204-W02MC	6025903
			5 m, 4-wire	DOL-1204-W05MC	6025904
			10 m, 4-wire	DOL-1204-W10MC	6025905



M12, 4-pin, PVC, chemical resistant

- **Cable material:** PVC, halogen-free
- **Connector material:** TPU
- **Locking nut material:** CuZn, nickel-plated

Figure	Connection type head A	Connection type head B	Connecting cable	Type	Part no.
	Female connector, M12, 4-pin, straight, unshielded	Cable, open conductor heads	2 m, 4-wire	DOL-1204-G02M	6009382
			5 m, 4-wire	DOL-1204-G05M	6009866
			10 m, 4-wire	DOL-1204-G10M	6010543
			15 m, 4-wire	DOL-1204-G15M	6010753
			20 m, 4-wire	DOL-1204-G20M	6034401
	Female connector, M12, 4-pin, straight, shielded	Cable, open conductor heads	5 m, 4-wire	DOL-1204-G05MA	6042100
	Female connector, M12, 4-pin, angled, unshielded	Cable, open conductor heads	2 m, 4-wire	DOL-1204-W02M	6009383
			5 m, 4-wire	DOL-1204-W05M	6009867
			10 m, 4-wire	DOL-1204-W10M	6010541
			15 m, 4-wire	DOL-1204-W15M	6036474
			20 m, 4-wire	DOL-1204-W20M	6033559
	Female connector, M12, 4-pin, angled, shielded	Cable, open conductor heads	5 m, 4-wire	DOL-1204-W05MA	6042098



M12, 5-pin, PUR, halogen-free, Oil / grease resistant

- **Cable material:** PUR, halogen-free
- **Connector material:** TPU
- **Locking nut material:** Zinc die-cast, nickel-plated

Figure	Connection type head A	Connection type head B	Connecting cable	Type	Part no.
	Female connector, M12, 5-pin, straight, unshielded	Cable, open conductor heads	2 m, 5-wire	DOL-1205-G02MC	6025906
			5 m, 5-wire	DOL-1205-G05MC	6025907
			10 m, 5-wire	DOL-1205-G10MC	6025908
	Female connector, M12, 5-pin, straight, shielded	Cable, open conductor heads	5 m, 5-wire	DOL-1205-G05MAC	6036384
			10 m, 5-wire	DOL-1205-G10MAC	6036385
			20 m, 5-wire	DOL-1205-G20MAC	6036386
	Female connector, M12, 5-pin, angled, unshielded	Cable, open conductor heads	2 m, 5-wire	DOL-1205-W02MC	6025909
			5 m, 5-wire	DOL-1205-W05MC	6025910
			10 m, 5-wire	DOL-1205-W10MC	6025911

M12, 5-pin, PVC, chemical resistant

- **Cable material:** PVC, halogen-free
- **Connector material:** TPU
- **Locking nut material:** CuZn, nickel-plated



Figure	Connection type head A	Connection type head B	Connecting cable	Type	Part no.
	Female connector, M12, 5-pin, straight, unshielded	Cable, open conductor heads	2 m, 5-wire	DOL-1205-G02M	6008899
			5 m, 5-wire	DOL-1205-G05M	6009868
			10 m, 5-wire	DOL-1205-G10M	6010544
	Female connector, M12, 5-pin, angled, unshielded	Cable, open conductor heads	2 m, 5-wire	DOL-1205-W02M	6008900
			5 m, 5-wire	DOL-1205-W05M	6009869
			10 m, 5-wire	DOL-1205-W10M	6010542







## M12, 8-pin, PUR, halogen-free

- **Cable material:** PUR, halogen-free
- **Connector material:** TPU
- **Locking nut material:** Zinc die-cast, nickel-plated

Figure	Connection type head A	Connection type head B	Connecting cable	Type	Part no.
	Female connector, M12, 8-pin, straight, unshielded	Cable, open conductor heads	2 m, 8-wire	DOL-1208-G02MC	6035620
			5 m, 8-wire	DOL-1208-G05MC	6035621
			10 m, 8-wire	DOL-1208-G10MC	6035622
			15 m, 8-wire	DOL-1208-G15MC	6038559
			20 m, 8-wire	DOL-1208-G20MC	6038560
	Female connector, M12, 8-pin, straight, shielded	Cable, open conductor heads	2 m, 8-wire	DOL-1208-G02MAH1	6032448
	Female connector, M12, 8-pin, angled, unshielded	Cable, open conductor heads	2 m, 8-wire	DOL-1208-W02MC	6035623
	Female connector, M12, 8-pin, angled, shielded	Cable, open conductor heads	5 m, 8-wire	DOL-1208-W05MC	6035624
			2 m, 8-wire	DOL-1208-W02MAS01	6029224



## M12, 8-pin, PVC

- **Cable material:** PVC, halogen-free
- **Connector material:** TPU
- **Locking nut material:** CuZn, nickel-plated

Figure	Connection type head A	Connection type head B	Connecting cable	Type	Part no.
	Female connector, M12, 8-pin, straight, shielded	Cable, open conductor heads	2 m, 8-wire	DOL-1208-G02MA	6020633
			5 m, 8-wire	DOL-1208-G05MA	6020993
	Female connector, M12, 8-pin, angled, shielded	Cable, open conductor heads	2 m, 8-wire	DOL-1208-W02MA	6020992
			5 m, 8-wire	DOL-1208-W05MA	6021033

## M12, 12-pin, PVC

- **Cable material:** PVC, halogen-free
- **Connector material:** TPU
- **Locking nut material:** CuZn, nickel-plated

Figure	Connection type head A	Connection type head B	Connecting cable	Type	Part no.
	Female connector, M12, 12-pin, angled, shielded	Cable, open conductor heads	5 m, 12-wire	DOL-1212-W05MAS02	6044109
	Female connector, M12, 12-pin, straight, shielded	Cable, open conductor heads	5 m, 12-wire, twisted pair	DOL1212-G05MAS02	6042754

→ For dimensional drawings, please see page K-259

## Connection cables with male connector and male connector

## M12, 4-pin, PUR, Ethernet

- **Cable material:** PUR, halogen-free



Figure	Connection type head A	Connection type head B	Connecting cable	Type	Part no.
	Male connector, M12, 4-pin, straight, D-coded, shielded	Male connector, RJ45, 8-pin, straight	2 m, 4-wire, AWG26	SSL-2J04-G02ME	6034414
			5 m, 4-wire, AWG26	SSL-2J04-G05ME	6035389
			10 m, 4-wire, AWG26	SSL-2J04-G10ME	6030928
			20 m, 4-wire, AWG26	SSL-2J04-G20ME	6036158
			25 m, 4-wire, AWG26	SSL-2J04-G25ME	6033555

Figure	Connection type head A	Connection type head B	Connecting cable	Type	Part no.
	Male connector, M12, 4-pin, angled, D-coded, shielded	Male connector, RJ45, 8-pin, straight	5 m	Connection cable	6039488

M12, 4-pin, PUR, halogen-free, EtherNet/IP

- **Cable material:** PUR, halogen-free
- **Locking nut material:** Zinc die-cast, nickel-plated

Figure	Connection type head A	Connection type head B	Connecting cable	Type	Part no.
	Male connector, M12, 4-pin, straight, D-coded, shielded	Male connector, M12, 4-pin, straight, D-coded	2 m, 4-wire, CAT5, CAT5e	SSL-1204-G02ME90	6045222
			5 m, 4-wire, CAT5, CAT5e	SSL-1204-G05ME90	6045277
			10 m, 4-wire, CAT5, CAT5e	SSL-1204-G10ME90	6045279

→ For dimensional drawings, please see page K-261

Connection cables with female connector and male connector

M12, 12-pin, PVC

- **Cable material:** PVC

Figure	Connection type head A	Connection type head B	Connecting cable	Type	Part no.
	Female connector, M12, 12-pin, straight, shielded	Male connector, M12, 12-pin, straight	5 m, 12-wire, twisted pair	DSL-1212-G05MAS02	6045234

### Dimensional drawings connection systems

Modules and gateways

SICK Memory Stick

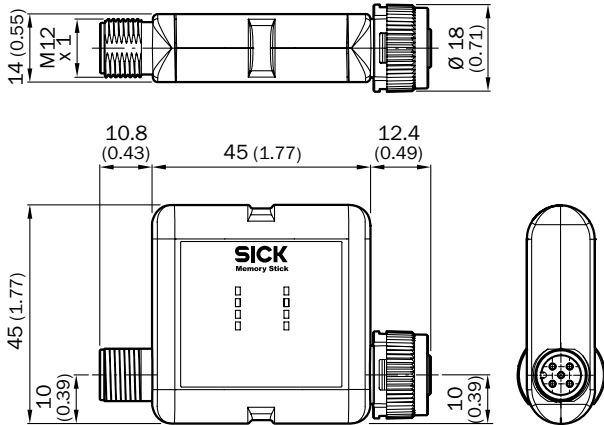

SiLink2 Master

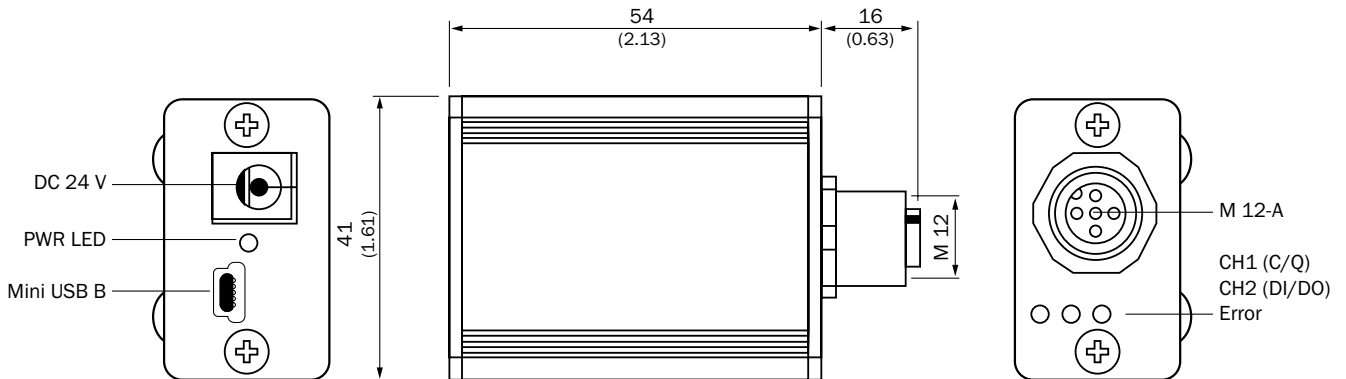

Plug connectors and cables

Connecting cables with female connector

DOL-0803-GxxMC

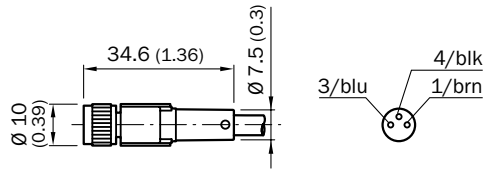

DOL-0803-GxxM

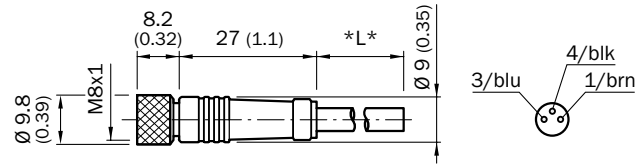

DOL-0803-WxxMC

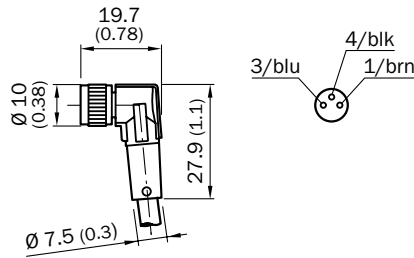

DOL-0803-WxxM

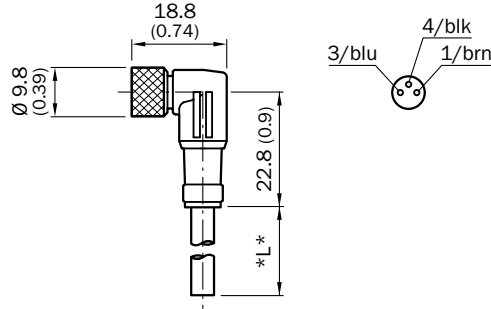

DOL-0804-GxxMC

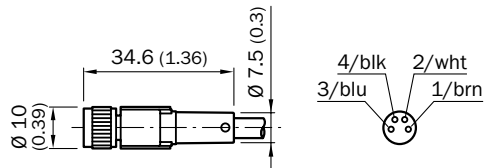

DOL-0804-GxxM

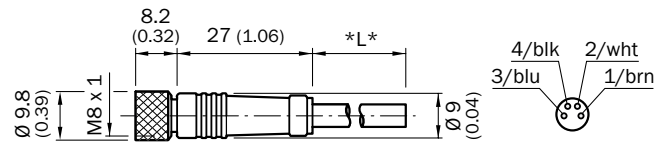

DOL-0804-WxxMC

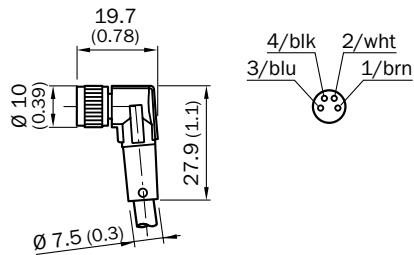

DOL-0804-WxxM

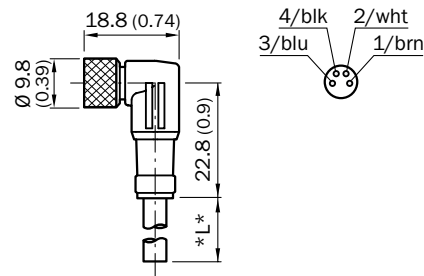

DOL-1204-GxxMC, DOL-1204-G10MAC

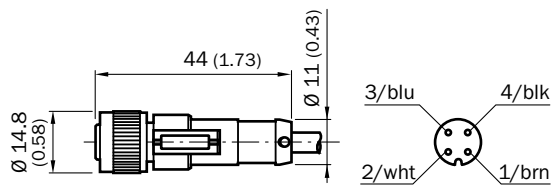

DOL-1204-WxxMC

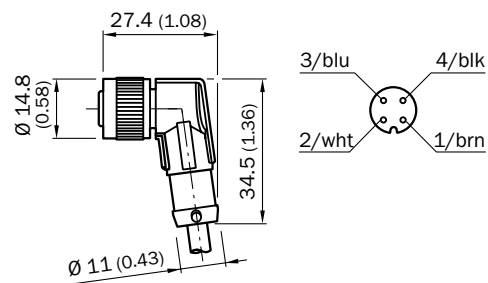

DOL-1204-GxxM

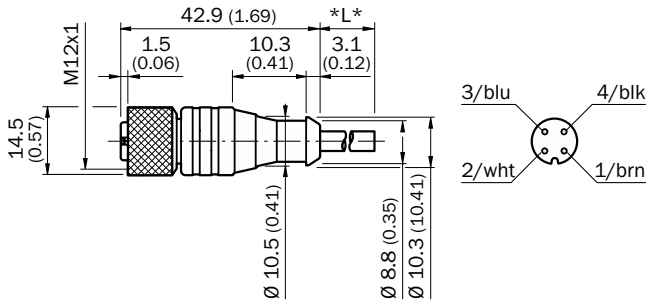

DOL-1204-G05MA

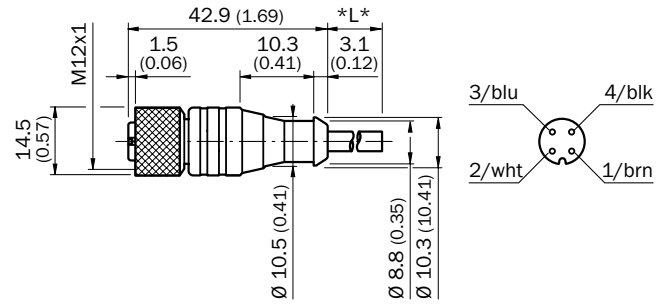

DOL-1204-WxxM

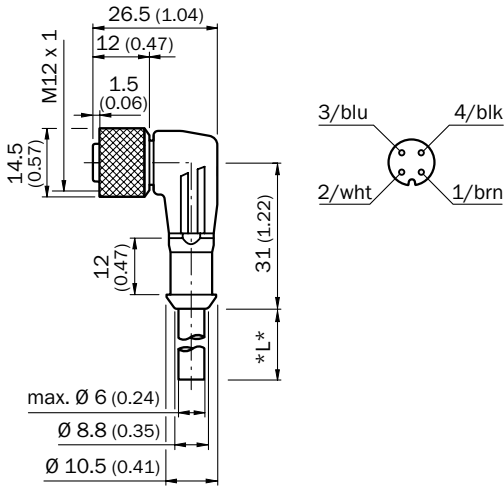

DOL-1204-W05MA

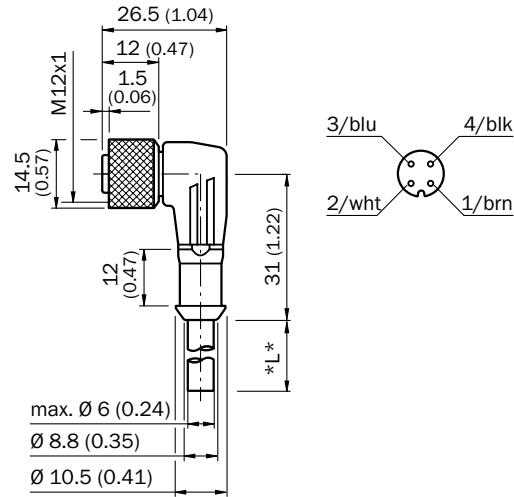

DOL-1205-GxxMC

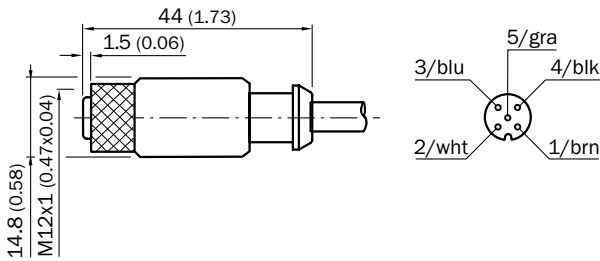

DOL-1205-GxxMAC

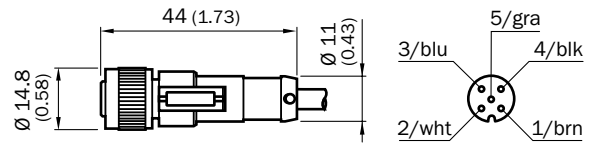

DOL-1205-WxxMC

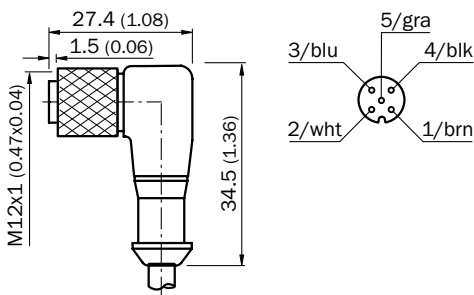

DOL-1205-GxxM

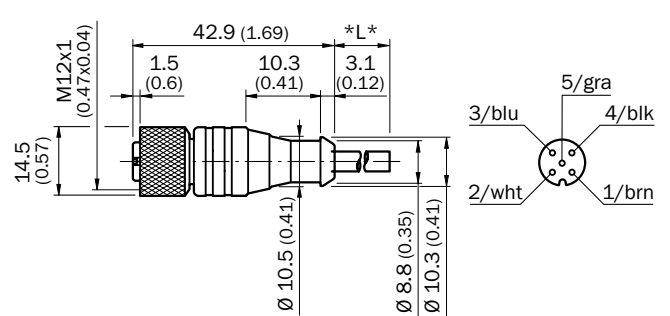

DOL-1205-WxxM

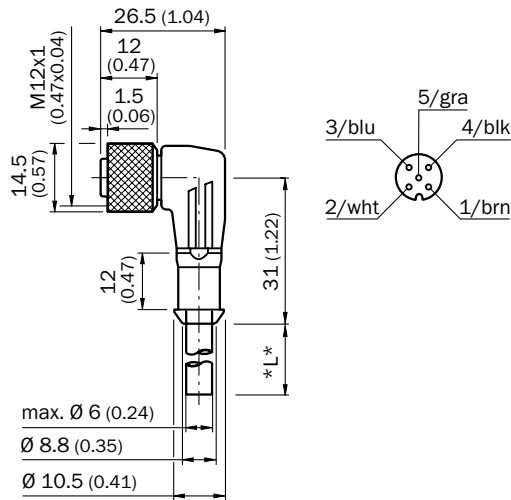

DOL-1208-G02MC

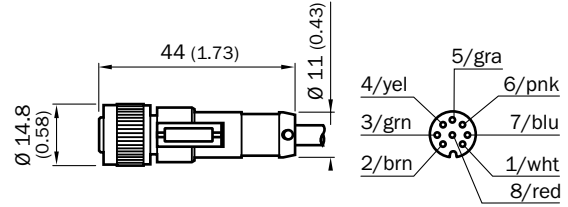

DOL-1208-G02MAH1

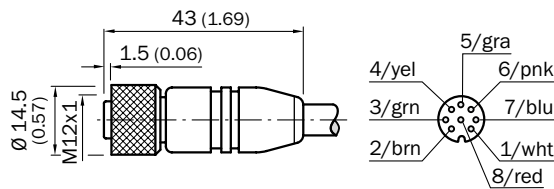

DOL-1208-WxxMC

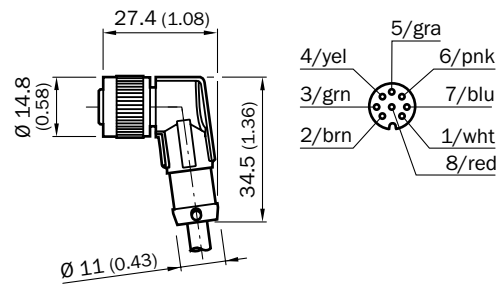

DOL-1208-GxxMA

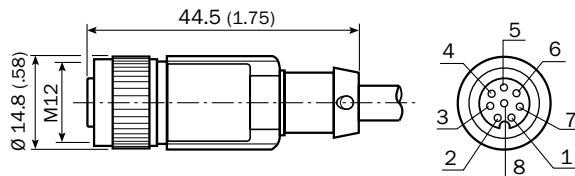

DOL-1208-WxxMA, DOL-1208-W02MAS01

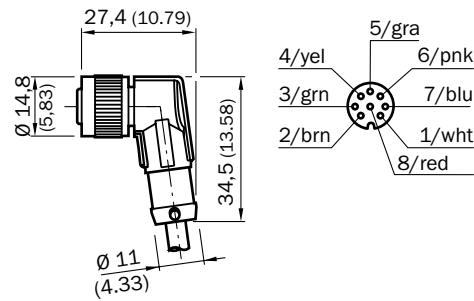

- ① Wht
- ② Brn
- ③ Grn
- ④ Yel
- ⑤ Gra
- ⑥ Pnk
- ⑦ Blu
- ⑧ Red

Dimensional drawings connection cables with male connector and male connector

SSL-2J04-GxxME

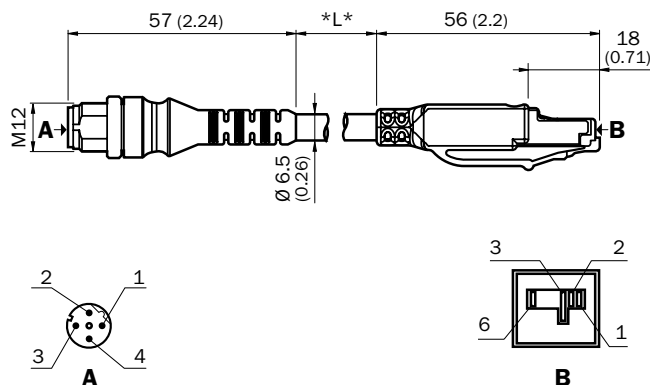

SSL-1204-GxxME90

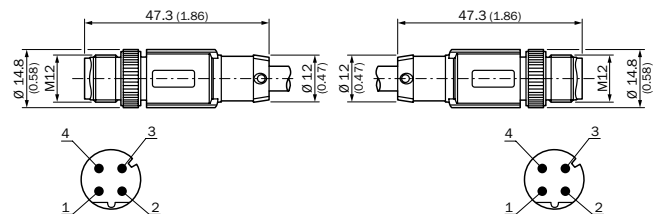

## A

### Ambient light immunity

Sensor's resistance to disruptive light sources such as HF tubes, flashing warning lamps, or sunlight. The ambient light immunity for sunlight is defined in lux via the threshold value at which an optical sensor is not yet affected. Optical filters, pulsed light, and multi-bit analysis ensure ambient light immunity.

## B

### Blanking input (AT)

Input with which the status of a sensor can be frozen by creating a voltage. The sensor is then "blanked" and the switching output Q is inactive. This may be required if the sensor is not to detect or switch in certain phases.

### Bus system

A system for transferring data between multiple participating devices via a common cable. It allows high data transmission rates and central control of all sensors. Additional information such as process data and diagnostics data can also be exchanged. SICK registration sensors use the IO-Link and CAN bus systems.

→ See "IO-Link" on page L-264

→ See "CAN" on page L-262

## C

### Cable

Cables have different properties depending on the sheath material used:

#### PUR cable

- Oil-resistant
- Resistant to drying out and formation of cracks

#### PVC cable

- Not suitable for long-term use in surroundings containing oil
- Not resistant to ozone and UV light

Due to the risk of breakage, cables must not be moved at temperatures below  $-5\text{ }^{\circ}\text{C}$ .

### CAN

Controller Area Network; an asynchronous, serial bus system. It connects together several devices with equal rights such as sensors and actuators. The data is transferred arbitrarily using identifiers. Owing to its high level of resistance to interference, real time capabilities, and low costs, CAN has become an established technology in many safety-relevant areas such as automotive and automation technology.

### CANopen

A CAN-based communication protocol. It enhances the CAN bus with a protocol structure. The KT8 CAN contrast sensor uses a CANopen-based protocol.

### CDRH

Center for Devices and Radiological Health; the publisher of regulations for laser products in the USA. Products for the US market must fulfill these regulations.

### Conformity

Awareness and satisfaction of the requirements of all relevant product safety directives for the respective market.

There are essentially two binding laws within the EU for SICK registration sensors:

- EMC Directive 89/336/EEC
- Low Voltage Directive 73/23/EEC

By displaying the CE marking on its products, the sensor manufacturer SICK declares that it has fulfilled the requirements of these directives.



In the USA, the national regulations of the OSHA (Occupational Safety and Health Act) and the NEC (National Electrical Code) apply. Testing is performed by UL (Underwriters Laboratories). Sensors must fulfill the UL approval conditions. If they do not, they may not be used in the USA. Devices with individual approval and an approval number from Underwriters Laboratories bear the letter "L" for "Listed".



UL also provides approval for the USA and Canada.



## Connection diagram

Wire colors are abbreviated as follows in the sensor connection diagram:

- blk = black
- blu = blue
- brn = brown
- gra = gray
- grn = green
- ora = orange
- pnk = pink
- red = red
- trq = turquoise
- vio = violet
- wht = white
- yel = yellow

The following abbreviations are used for the assignment:

- AT = Blanking input
- Teach = Input: External teach-in
- Fine/Coarse = Input: Fine/coarse
- L+ = Power supply
- L/D = Input light/dark switching
- M = Mass
- not connected = not connected
- Q/Q = Switching output (may have additional coding or numbers)
- Q<sub>A</sub> = Analog output

## D

### Drift correction

Automatic adjustment of the switching threshold of a sensor in ongoing operation.

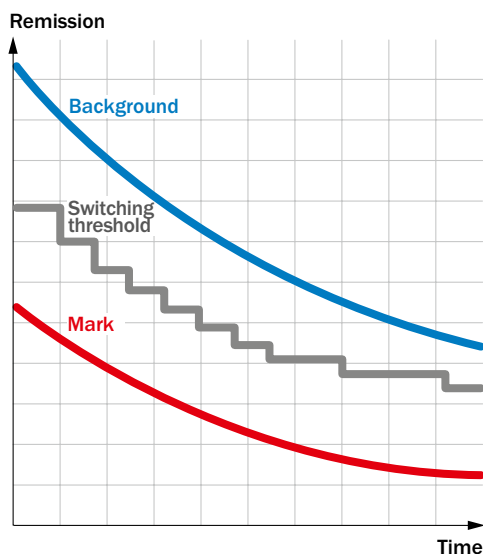

Fig. Drift correction

To do this, for example, the greatest (lightest) measured value will be searched for over a certain number of switching cycles. This is then compared with the largest measured value from

the teach-in process. If this measured value changes, the switching threshold is corrected proportionally.

During contamination phases, the switching threshold is corrected and lowered step by step. After the sensor has been cleaned, the switching threshold adjustment returns the switching threshold back to the teach-in switching threshold.

## E

### Electromagnetic compatibility (EMC)

According to EC Directive 2004/108/EC on electromagnetic compatibility, systems and components must satisfy certain properties in order to function smoothly in an electromagnetic environment.

This is achieved as follows:

Restrict sources of interference in devices or design devices to be sufficiently resistant to interference. EMC is regulated by EU Directives and Standards. SICK also has its own stringent standards that exceed the statutory requirements.

### Enclosure rating

Indicates the extent of a device's protection against contact with impurities such as dust or water. The designation for enclosure ratings begins with the letters IP, followed by an initial character indicating the strength of protection against contact and impurities, and a second character for the strength of protection against water ingress.

→ See "Fig. Enclosure ratings" on page L-268

### External teach-in

Allows the user to make the required settings via the control cable of the sensor.

## F

### Function indicator

On the function indicator, the yellow LED shows the status of the switching output for the sensors. Some sensors also have a second LED that indicates operational readiness.

## H

### Housing material

The housing for SICK registration sensors is made from the following materials:

- Aluminium
- Zinc die cast (powder-coated)
- Plastic, e.g. ABS

If the chemicals frequently or constantly affect the sensor, an application test is required.

## IJ

### Input, external teach (ET)

Input with which a new switching threshold is taught into the sensor via an external input signal. This enables the switching threshold to be altered remotely.

### IO-Link

## IO-Link

A communication system used in automation technology developed through the collaboration of leading automation technology manufacturers. IO-Link is a point-to-point connection between the control system, sensors, and actuators that allows centrally controlled configuration and readout of the connected devices.

This communication technology and its features allow machines and systems to be operated much more effectively:

- Reduces machine downtime and changeover times
- Convenient parameter configuration
- Improves process quality through continuous monitoring of process parameters

### Jitter

Variation of the switching output over time, caused by the tolerances of electronic components that are always present. This produces variances in a sensor's response time. The response time can therefore be slightly shorter or longer.

→ See "Response time" on page L-265

## L

### Laser classes

Division of lasers and LEDs into device classes, in ascending order based on the danger to human eyes and skin. The table on the following page shows how they are divided up based on standards EN 60825-1 and DIN VDE 0837. The latter is no longer used in Germany for new lasers.

→ See "Table: Laser classes" on page L-266

### LED classification

IEC 62471: used since 2006 for LED devices "Safety of Lamps and Lamp Systems".

### Light/dark switching

Sensor setting that can be used to invert the logic of the output. With the "light switching" setting, the switching output (Q) is activated as soon as the receiver element receives more light than the defined switching threshold. With the "dark-switching" setting, the switching output (Q) is activated when the switching threshold is not met.

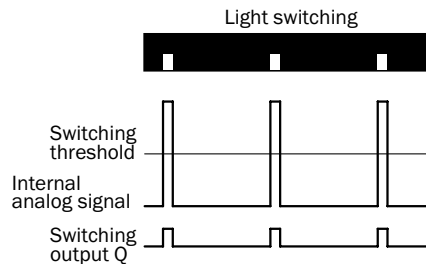

Fig. Light switching

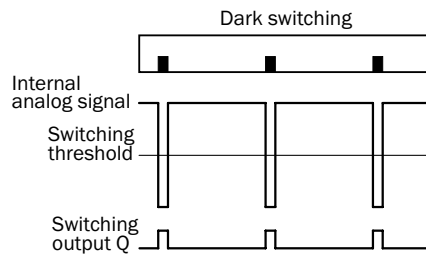

Fig. Dark switching

### Light spot direction

The switching properties of a sensor are considered optimal if the light spot appears parallel to the mark in the measuring range during measurement.

Depending on the sensor type, the light spot appears from the sensor housing lengthwise or transverse to the narrow side. With some contrast sensors, this outlet can be selected.

### Luminescence scale

Scale in the form of a card printed with luminescence marks of different intensities (10% to 200%). This allows sensor readability to be checked for different signal intensities and thus to establish which intensity a luminescence mark needs to have to allow it to be processed without errors. The pigments of the luminescence marks on the card are so stable that they can be used for reference in the long term.

## N

### No false triggering on power-up

A function that only enables the switching output of a sensor after a self-test has been successfully performed when the sensor is switched on. This ensures a defined start-up status and avoids undesired switching.



# O

## OFF delay (release delay)

Artificial pulse stretching for switching signal.

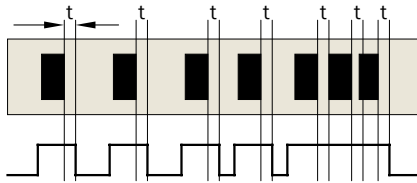

Fig. OFF delay (release delay)

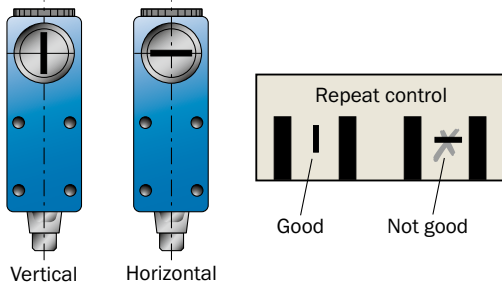

Fig. Light spot direction

## Output current

The current for analog devices, which is present at the output and varies depending on the distance between the target and sensor, e.g. in a range of 4–20 mA.

## Output voltage

The voltage for analog devices, which is present at the output and varies depending on the distance between the target and sensor, e.g. in a range of 0–10 V.

# P

## Plug connector

Connection for exchanging electrical and optical signals. SICK registration sensors have round connectors of size M8 or M12 with screw fittings.

## Protection class

Protection classes specify which safety measures must be in place for electrical equipment to prevent an electric shock. Protection classes are defined in DIN EN 61140. There are four protection classes ranging from “Basic insulation” (Class 0) to “Safety extra-low voltage, double insulation, safety transformer” (Class 3). SICK registration sensors have protection class 2 or 3.



Protection class 1



Protection class 2



Protection class 3

# R

## Repeatability

Difference between measurement results from a measurement range with multiple measurements under identical conditions.

## Reproducibility

→ See “Repeatability” on page L-265

## Residual ripple

An AC portion of voltage that overlays the operating voltage. This remains after rectification and smoothing of alternating current. For reliable sensor operation, the residual ripple in the power supply must not exceed a specified value, e.g. 5 V<sub>SS</sub> for SICK contrast sensors.

## Response time

The time between an event occurring (set threshold is exceeded) and the sensor switching (switching operation). An event is, for example, when a print mark appears in the sensor’s light spot.

The contrast marks move toward the light spot generated by the sender and, when they overshoot the light spot, typically generate an edge for the received signal (see diagram). The cycle time (tc) determines the positioning accuracy with which the edge signal is detected.

Edge detection can fluctuate (jitter) by approximately one period (cycle time) depending on the temporal sequence of the send pulses.

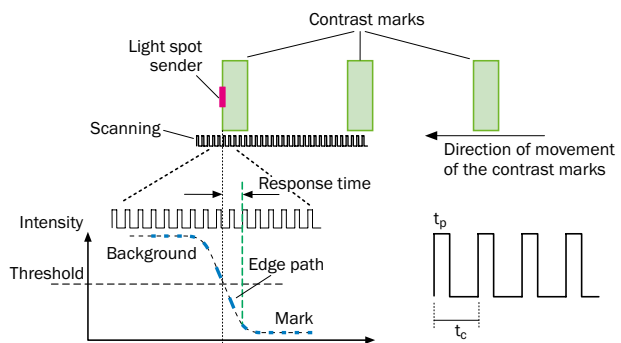

Fig. Response time: tp = sensor switch-on time; tc = sensor cycle time

## Resolution

The resolution describes the smallest possible change that a sensor can detect.



Risk class	Class 1	Class 1M	Class 2	Class 2M	Class 3R	Class 3B	Class 4
<b>Description</b>	<ul style="list-style-type: none"> <li>Not dangerous, eye-safe</li> </ul>	<ul style="list-style-type: none"> <li>Eye-safe when not used with optical concentration instruments</li> </ul>	<ul style="list-style-type: none"> <li>Not dangerous under short-term irradiation, eye-safe due to the aversion response and blink reflex</li> </ul>	<ul style="list-style-type: none"> <li>In the visual spectrum under short-term irradiation up to 0.25 s, not dangerous in the same manner as Class 2</li> <li>Blink reflex, depending on whether this relates to a divergent or spread beam, may be unsafe when used with optical instruments</li> </ul>	<ul style="list-style-type: none"> <li>Irradiation is a maximum of five times higher than the values for Class 1 (or Class 2)</li> <li>Risk is somewhat lower than with Class 3B</li> </ul>	<ul style="list-style-type: none"> <li>Dangerous to the eyes and, in special cases, also to the skin</li> </ul>	<ul style="list-style-type: none"> <li>Very dangerous to the eyes and dangerous to the skin</li> </ul>
<b>Safety measures</b>							
<b>Protective housing</b>					Aim for Class 1		
<b>Safety locks</b>					Prevents the removal of covers		
<b>Key-operated switch</b>					Authorized personnel		
<b>Operating elements</b>					As far as possible from the beam, use adjustment indicators		
<b>Permanently installed optical protective device</b>					Limit irradiation (scatter irradiation)		
<b>Laser protection officer</b>					Order in writing		
<b>Laser protection goggles</b>		When observing the direct beam			Always required, adjust the room brightness accordingly		
<b>Access restrictions</b>					Warning notices, limit times		
<b>Instruction</b>					Required		

Table: Laser classes

## S

### Sensing distance

Distance between the front edge of the lens (last optical surface of sensor) and the surface of the target.

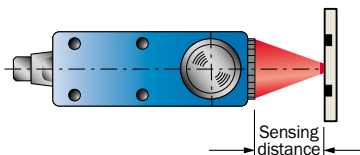

Fig. Sensing distance

### Sensing range tolerance

Sensing distance operating range within which the sensor reliably functions. The size of the operating range depends on the clarity of the feature to be detected.

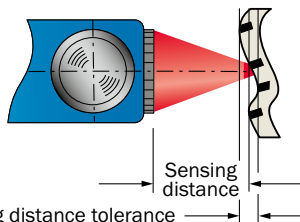

Fig. Sensing range tolerance

### Shiny surfaces

During detection on shiny surfaces, the switching reliability can be increased by tilting the sensor 15 degrees to the vertical. This reflects the shiny component of the reflected light away from the sensor and the sensor then only detects the diffuse reflected light.

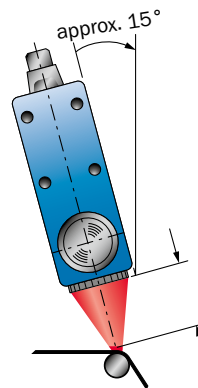

Fig. Shiny surfaces

### Storage banks

Storage banks are a sensor's storage areas. They can be used to configure machines or systems for different applications, e.g. changing targets.

### Supply voltage

The supply voltage describes the voltage range within which the sensor works properly.

## Switching frequency

Number of switching processes that a sensor can perform in Hertz (Hz).

The higher the switching frequency, the more intervals are available for a switching process in a given period. The response time and jitter are therefore reduced.

## Switching output

A switching output is the output via which the output state of the sensor is digitally output.

### NPN output

The negative potential is connected to the load here. This output is also referred to as negative switching or current-sinking.

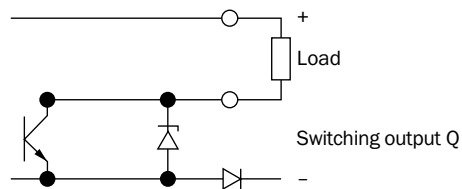

### PNP output

The positive potential is connected to the load here. This output is also known as current sourcing or positive switching.

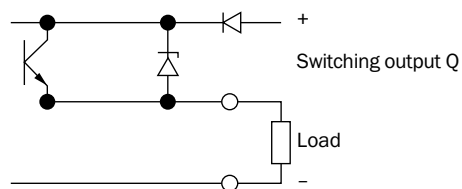

SICK registration sensors are available with switching types NPN and PNP.

## Switching output Q

Output (cable) via which the output state of the sensor is digitally output.

## T

### Teach-in

Teach-in of features for an object to be detected in the sensor's electronics. In this way, the object is brought into the sensor's light path and its characteristic remission is processed by the receiver. The learning process for determining the switching threshold is started by pressing a button on the device or via an external control cable.

A number of different teach-in procedures allow easy acquisition of switching thresholds. This greatly accelerates commissioning and adjustment of the sensor.

→ See "Teach-in procedure" on page L-267

## Teach-in procedure

Teach-in can be used to configure sensors in various ways:

- 1-point teach-in
- 2-point teach-in
- Dynamic teach-in

The procedures used for the relevant sensor type are explained in detail in the individual chapters and operating instructions.

## Timer stage

→ See "Response time" on page L-265

## W

### Wavelength

SICK registration sensors use wavelengths in the electromagnetic spectrum: from 370 nm (UV light with luminescence sensors), to 650 nm (red light for contrast and color sensors), through to 1000 nm (infrared light for fork sensors).

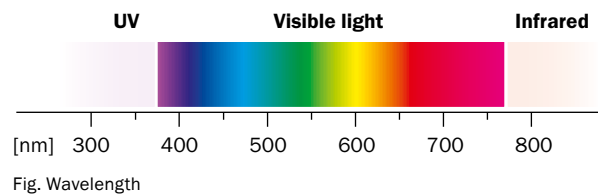

<b>2nd digit:</b> Protection against ingress of water											
		No protection	Drip-water vertical	Drip-water tilted	Spray water	Splash water	Jet water	Strong jet of water	Temporary immersion	Lasting immersion	100 bar, 16 l/min., 80 °C
IEC 529 DIN 40050		IP...0	IP...1	IP...2	IP...3	IP...4	IP...5	IP...6	IP...7	IP...8	IP...9K
<b>IP 0...</b> No protection		IP 00									
<b>IP 1...</b> Size of foreign body: $\geq 50 \text{ mm } \varnothing$		IP 10	IP 11	IP 12							
<b>IP 2...</b> Size of foreign body: $\geq 12 \text{ mm } \varnothing$		IP 20	IP 21	IP 22	IP 23						
<b>IP 3...</b> Size of foreign body: $\geq 2.5 \text{ mm } \varnothing$		IP 30	IP 31	IP 32	IP 33	IP 34					
<b>IP 4...</b> Size of foreign body: $\geq 1 \text{ mm } \varnothing$		IP 40	IP 41	IP 42	IP 43	IP 44					
<b>IP 5...</b> Dust-protected		IP 50			IP 53	IP 54	IP 55	IP 56			
<b>IP 6...</b> Dust-proof		IP 60					IP 65	IP 66	IP 67		IP 69K

Fig. Enclosure ratings



Type	Part no.	Page	Type	Part no.	Page
AL20E-NM111	1046460	→ H-220	DOL-0803-W02M	6008489	→ K-254
AL20E-NM331	1046461	→ H-220	DOL-0803-W05MC	6025892	→ K-254
AL20E-PM111	1046463	→ H-220	DOL-0803-W05M	6022010	→ K-254
AL20E-PM331	1046462	→ H-220	DOL-0803-W10MC	6025893	→ K-254
AT20D-NM111	1046466	→ H-220	DOL-0803-W10M	6022012	→ K-254
AT20D-NM331	1046467	→ H-220	DOL-0803-W15M	6036473	→ K-254
AT20D-PM111	1046464	→ H-220	DOL-0804-G02MC	6025894	→ K-255
AT20D-PM331	1046465	→ H-220	DOL-0804-G02M	6009870	→ K-255
AT20E-NM111	1046458	→ H-220	DOL-0804-G03M	6049342	→ K-255
AT20E-NM331	1046459	→ H-220	DOL-0804-G05MAC	6050809	→ K-255
AT20E-PM111	1044484	→ H-220	DOL-0804-G05MC	6025895	→ K-255
AT20E-PM331	1045990	→ H-220	DOL-0804-G05M	6009872	→ K-255
BEF-AP-KTMS01	2068786	→ K-244	DOL-0804-G10MAC	6050808	→ K-255
BEF-KHS-G01	2022464	→ K-244	DOL-0804-G10MC	6025896	→ K-255
BEF-KHS-K01	2022718	→ K-244	DOL-0804-G10M	6010754	→ K-255
BEF-KHS-KH1	2022726	→ K-244	DOL-0804-G1M5	6049343	→ K-255
BEF-KHS-L01	2023057	→ K-244	DOL-0804-G20MC	6051148	→ K-255
BEF-KHS-N04N	2051620	→ K-244	DOL-0804-G2M5	6049344	→ K-255
BEF-KHS-N04	2051610	→ K-245	DOL-0804-W02MC	6025897	→ K-255
BEF-KHS-N08N	2051616	→ K-244	DOL-0804-W02M	6009871	→ K-255
BEF-KHS-N08	2051607	→ K-245	DOL-0804-W05MC	6025898	→ K-255
BEF-KHS-N11N	2071081	→ K-245	DOL-0804-W05M	6009873	→ K-255
BEF-M12GF-A	2059414	→ K-245	DOL-0804-W10MC	6025899	→ K-255
BEF-MS12G-A	4056054	→ K-245	DOL-0804-W10M	6010755	→ K-255
BEF-MS12G-B	4056055	→ K-245	DOL-1204-G02MC	6025900	→ K-256
BEF-MS12L-A	4056052	→ K-245	DOL-1204-G02M	6009382	→ K-255
BEF-MS12L-B	4056053	→ K-245	DOL-1204-G05MA	6042100	→ K-256
BEF-MS12Z-A	4056056	→ K-245	DOL-1204-G05MC	6025901	→ K-256
BEF-MS12Z-B	4056057	→ K-245	DOL-1204-G05M	6009866	→ K-255
BEF-RMC-D12	5321878	→ K-245	DOL-1204-G10MAC	6041797	→ K-256
BEF-W100-A	5311520	→ K-244	DOL-1204-G10MC	6025902	→ K-255
BEF-W100-B	5311521	→ K-244	DOL-1204-G10M	6010543	→ K-255
BEF-WN-DT20	4043524	→ K-244	DOL-1204-G15MC	6034749	→ K-256
BEF-WN-W100-S01	4073866	→ K-244	DOL-1204-G15M	6010753	→ K-255
BEF-WN-W9-2	2022855	→ K-244	DOL-1204-G20MC	6034750	→ K-256
Connection cable	6039488	→ K-258	DOL-1204-G20M	6034401	→ K-255
CS81-N1112	1028228	→ C-102	DOL-1204-G25MC	6034751	→ K-255
CS81-N3612	1028229	→ C-102	DOL-1204-W02MC	6025903	→ K-256
CS81-P1112	1028224	→ C-102	DOL-1204-W02M	6009383	→ K-255
CS81-P3612	1028225	→ C-102	DOL-1204-W05MA	6042098	→ K-256
CS84-N1112	1028230	→ C-102	DOL-1204-W05MC	6025904	→ K-256
CS84-N3612	1028231	→ C-102	DOL-1204-W05M	6009867	→ K-255
CS84-P1112	1028226	→ C-102	DOL-1204-W10MC	6025905	→ K-256
CS84-P3612	1028227	→ C-102	DOL-1204-W10M	6010541	→ K-255
CSM-WN11122P	1067293	→ C-96	DOL-1204-W15M	6036474	→ K-256
CSM-WP11122P	1067291	→ C-96	DOL-1204-W20M	6033559	→ K-256
CSM-WP117A2P	1067294	→ C-96	DOL-1205-G02MC	6025906	→ K-256
DOL-0803-G01MC	6036455	→ K-254	DOL-1205-G02M	6008899	→ K-256
DOL-0803-G02MC	6025888	→ K-254	DOL-1205-G05MAC	6036384	→ K-256
DOL-0803-G02M	6010785	→ K-254	DOL-1205-G05MC	6025907	→ K-256
DOL-0803-G03MC	6038991	→ K-254	DOL-1205-G05M	6009868	→ K-256
DOL-0803-G05MC	6025889	→ K-254	DOL-1205-G10MAC	6036385	→ K-256
DOL-0803-G05M	6022009	→ K-254	DOL-1205-G10MC	6025908	→ K-256
DOL-0803-G10MC	6025890	→ K-254	DOL-1205-G10M	6010544	→ K-256
DOL-0803-G10M	6022011	→ K-254	DOL-1205-G20MAC	6036386	→ K-256
DOL-0803-G15M	6036472	→ K-254	DOL-1205-W02MC	6025909	→ K-256
DOL-0803-G20MC	6036456	→ K-254	DOL-1205-W02M	6008900	→ K-256
DOL-0803-W02MC	6025891	→ K-254	DOL-1205-W05MC	6025910	→ K-256

Type	Part no.	Page
DOL-1205-W05M	6009869	→ K-256
DOL-1205-W10MC	6025911	→ K-256
DOL-1205-W10M	6010542	→ K-256
DOL-1208-G02MAH1	6032448	→ K-257
DOL-1208-G02MA	6020633	→ K-257
DOL-1208-G02MC	6035620	→ K-257
DOL-1208-G05MA	6020993	→ K-257
DOL-1208-G05MC	6035621	→ K-257
DOL-1208-G10MC	6035622	→ K-257
DOL-1208-G15MC	6038559	→ K-257
DOL-1208-G20MC	6038560	→ K-257
DOL-1208-W02MAS01	6029224	→ K-257
DOL-1208-W02MA	6020992	→ K-257
DOL-1208-W02MC	6035623	→ K-257
DOL-1208-W05MA	6021033	→ K-257
DOL-1208-W05MC	6035624	→ K-257
DOL-1212-W05MAS02	6044109	→ K-257
DOL1212-G05MAS02	6042754	→ K-257
DSL-1212-G05MAS02	6045234	→ K-258
KT10W-2N1115	1028233	→ B-82
KT10W-2N2115	1029071	→ B-82
KT10W-2P1115	1028232	→ B-82
KT10W-2P2115	1029070	→ B-82
KT3L-N3216	1026245	→ B-40
KT3L-P3216	1026244	→ B-40
KT5G-2N1111	1015981	→ B-47
KT5G-2N1121	1015983	→ B-47
KT5G-2N1151	1016385	→ B-47
KT5G-2N1211	1015985	→ B-47
KT5G-2N1251	1022582	→ B-47
KT5G-2N1311	1015988	→ B-47
KT5G-2N1351	1016728	→ B-47
KT5G-2N2111	1015990	→ B-47
KT5G-2N2211	1015991	→ B-47
KT5G-2N2311	1015992	→ B-47
KT5G-2N2351	1018068	→ B-47
KT5G-2P1111	1015993	→ B-47
KT5G-2P1121	1015997	→ B-47
KT5G-2P1151	1016195	→ B-47
KT5G-2P1211	1015999	→ B-47
KT5G-2P1221	1016001	→ B-47
KT5G-2P1251	1016196	→ B-47
KT5G-2P1311	1016003	→ B-47
KT5G-2P1321	1016005	→ B-47
KT5G-2P1351	1016197	→ B-47
KT5G-2P2111	1016008	→ B-47
KT5G-2P2121	1016009	→ B-47
KT5G-2P2151	1017809	→ B-47
KT5G-2P2211	1016010	→ B-47
KT5G-2P2221	1016011	→ B-47
KT5G-2P2311	1016012	→ B-47
KT5G-2P2321	1016013	→ B-47
KT5G-2P2351	1018067	→ B-47
KT5M-2N1111	1048489	→ B-46
KT5M-2P1151	1044400	→ B-46
KT5RG-2N1116	1027394	→ B-48
KT5RG-2P1116	1027393	→ B-48
KT5RG-2P1126	1027396	→ B-48

Type	Part no.	Page
KT5W-2N1113	1016630	→ B-48
KT5W-2N1116D	1026540	→ B-48
KT5W-2N1116	1018045	→ B-49
KT5W-2N1126D	1026582	→ B-49
KT5W-2N1213	1016716	→ B-48
KT5W-2N1216D	1026580	→ B-48
KT5W-2N1216	1019022	→ B-49
KT5W-2N1316D	1026581	→ B-48
KT5W-2N1316	1022678	→ B-49
KT5W-2N2113	1018042	→ B-48
KT5W-2N2116D	1026583	→ B-49
KT5W-2P1113	1016629	→ B-48
KT5W-2P1116D	1026538	→ B-48
KT5W-2P1116	1018044	→ B-49
KT5W-2P1123	1017810	→ B-48
KT5W-2P1126D	1026579	→ B-48
KT5W-2P1126	1018587	→ B-49
KT5W-2P1213	1016715	→ B-48
KT5W-2P1216D	1026577	→ B-48
KT5W-2P1216	1018586	→ B-49
KT5W-2P1316D	1026578	→ B-48
KT5W-2P1316	1018961	→ B-49
KT5W-2P2113	1018043	→ B-48
KT5W-2P2116D	1026584	→ B-48
KT5W-2P2116	1022312	→ B-49
KT5W-2P2216	1019020	→ B-48
KT5W-2P2323	1022165	→ B-48
KT6W-2N5116	1046010	→ B-68
KT6W-2N6116	1046012	→ B-68
KT6W-2P5116	1046013	→ B-68
KT6W-2P6116	1046014	→ B-68
KT8L-N3656	1041263	→ B-74
KT8L-N3756	1041352	→ B-74
KT8L-P3656	1041262	→ B-74
KT8L-P3756	1041351	→ B-74
KT8W-N111C	1028223	→ B-74
KT8W-P111C	1027919	→ B-74
KT8W-P121C	1043689	→ B-74
KTL5G-2N11	1016295	→ B-60
KTL5G-2N51	1016951	→ B-60
KTL5G-2P11	1016294	→ B-60
KTL5G-2P14	1022091	→ B-60
KTL5G-2P24	1019162	→ B-60
KTL5G-2P51	1016950	→ B-60
KTL5W-2N13	1019661	→ B-60
KTL5W-2N16	1025995	→ B-60
KTL5W-2P13	1027562	→ B-60
KTL5W-2P16	1026006	→ B-60
KTL5W-2P23	1019551	→ B-60
KTM-MB31111P	1062202	→ B-26
KTM-MB31112P	1070053	→ B-26
KTM-MB31191P	1062203	→ B-26
KTM-MB8A191P	1066885	→ B-26
KTM-MN31181P	1071947	→ B-32
KTM-MP11181P	1072473	→ B-32
KTM-MP31181P	1065756	→ B-32
KTM-MP31182P	1070490	→ B-32
KTM-MP317A1P	1071482	→ B-32





Type	Part no.	Page	Type	Part no.	Page
KTM-WN11181P	1062200	→ B-32	LUTM-UP81162P	1067295	→ D-116
KTM-WN11182P	1062150	→ B-32	LUTM-UP817A2P	1067297	→ D-116
KTM-WN117A1P	1061787	→ B-32	ML20M-P1211	1044675	→ I-234
KTM-WN1A182V	1062148	→ B-32	OBJ-210	2010945	→ K-249
KTM-WP11181P	1062199	→ B-32	OBJ-211	1004936	→ K-249
KTM-WP11182P	1062201	→ B-32	OBJ-212	1011506	→ K-249
KTM-WP11282P	1072002	→ B-32	OBJ-LUT3-10	2016348	→ K-249
KTM-WP117A1P	1061770	→ B-32	OBJ-LUT3-20	2016349	→ K-249
KTM-WP1A182V	1052956	→ B-32	OBJ-LUT3-50	2016350	→ K-249
KTM-WP1A7A2V	1062147	→ B-32	OPR20G-RB111517	1065685	→ E-152
LBSA32900	7020040	→ K-250	OPR20G-RB317537A90	1072052	→ E-152
LBSAA23900	7020103	→ K-249	OPR20G-RB317537	1068822	→ E-152
LBSAT32900	7020036	→ K-249	OPR20G-RB417537	1068823	→ E-152
LBSF32900	7020038	→ K-250	OPR20G-RB517537A01	1072051	→ E-152
LBSM12900	7020054	→ K-249	REF-AX-001	2049250	→ K-249
L BSP16900	7020044	→ K-250	REF-AX-002	2049249	→ K-249
LBSR16900	7020050	→ K-250	REF-AX-004	2062695	→ K-249
LBSR32900	7020042	→ K-250	REF-AX-005	2069161	→ K-249
LBSR40900	7020052	→ K-250	REF-AX-007	2080183	→ K-249
LBST32900	7020046	→ K-249	RS10-M111	1060116	→ G-201
LBSTA325000	7022348	→ K-249	RS25-WF334000	1062005	→ G-208
LBSTA32900	7020048	→ K-249	RS25-WL334000	1061571	→ G-208
LISA32900	7020039	→ K-250	RS25 - optical sensor head	-	→ G-208
LISAA23900	7020102	→ K-250	SICK Memory Stick	1064290	→ K-254
LISAT32900	7020035	→ K-250	SiLink2 Master	1061790	→ K-254
LISF32900	7020037	→ K-250	SSL-1204-G02ME90	6045222	→ K-258
LISM12900	7020053	→ K-250	SSL-1204-G05ME90	6045277	→ K-258
LISP16900	7020043	→ K-250	SSL-1204-G10ME90	6045279	→ K-258
LISR16900	7020049	→ K-250	SSL-2J04-G02ME	6034414	→ K-257
LISR32900	7020041	→ K-250	SSL-2J04-G05ME	6035389	→ K-257
LSSF32500	7122528	→ K-249	SSL-2J04-G10ME	6030928	→ K-257
LUM-FT	1004460	→ K-250	SSL-2J04-G20ME	6036158	→ K-257
LUM-KLK	1002959	→ K-250	SSL-2J04-G25ME	6033555	→ K-257
LUT3-610	1015396	→ D-122	UFN3-70B413	6049678	→ F-172
LUT3-620	1015397	→ D-122	UFN3-70N415	6049680	→ F-172
LUT3-650	1015398	→ D-122	UFN3-70P415	6049679	→ F-172
LUT8U-11101	1046711	→ D-128	WF120-40B410	6028435	→ F-177
LUT8U-11201	1047042	→ D-128	WF120-40B416	6028456	→ F-177
LUT8U-11301	1047043	→ D-128	WF120-60B410	6028442	→ F-177
LUT8U-11311	1047045	→ D-128	WF120-60B416	6028463	→ F-177
LUT8U-11321	1047046	→ D-128	WF120-95B410	6028449	→ F-177
LUT8U-11331	1047047	→ D-128	WF120-95B416	6028470	→ F-177
LUT8U-11401	1047044	→ D-128	WF15-40B410	6028430	→ F-176
LUT8U-11701	1047048	→ D-128	WF15-40B416	6028452	→ F-176
LUT9B-11626	1047056	→ D-135	WF15-60B410	6028438	→ F-176
LUT9U-11106	1047049	→ D-134	WF15-60B416	6028459	→ F-176
LUT9U-11206	1047050	→ D-134	WF15-95B410	6028445	→ F-176
LUT9U-11306	1046712	→ D-134	WF15-95B416	6028466	→ F-176
LUT9U-11316	1047052	→ D-134	WF2-40B410	6028428	→ F-176
LUT9U-11326	1047053	→ D-134	WF2-40B416	6028450	→ F-176
LUT9U-11336	1047054	→ D-134	WF2-60B410	6028436	→ F-176
LUT9U-11406	1047051	→ D-134	WF2-60B416	6028457	→ F-176
LUT9U-11606	1047414	→ D-135	WF2-95B410	6028443	→ F-176
LUT9U-12206	1046749	→ D-134	WF2-95B416	6028464	→ F-176
LUT9U-12306	1047055	→ D-134	WF30-40B410	6028431	→ F-176
LUT9U-P120L	1046188	→ D-134	WF30-40B416	6028453	→ F-176
LUT9U-P130L	1045606	→ D-134	WF30-60B410	6028439	→ F-176
LUTM-UN81162P	1067296	→ D-116	WF30-60B416	6028460	→ F-176



Type	Part no.	Page
WF30-95B410	6028446	→ F-176
WF30-95B416	6028467	→ F-176
WF5-40B410	6028429	→ F-176
WF5-40B416	6028451	→ F-176
WF5-60B410	6028437	→ F-176
WF5-60B416	6028458	→ F-176
WF5-95B410	6028444	→ F-176
WF5-95B416	6028465	→ F-176
WF50-40B410	6028432	→ F-177
WF50-40B416	6028454	→ F-177
WF50-60B410	6028440	→ F-177
WF50-60B416	6028461	→ F-177
WF50-95B410	6028447	→ F-177
WF50-95B416	6028468	→ F-177
WF80-40B410	6028433	→ F-177
WF80-40B416	6028455	→ F-177
WF80-60B410	6028441	→ F-177
WF80-60B416	6028462	→ F-177
WF80-95B410	6028448	→ F-177
WF80-95B416	6028469	→ F-177
WFL120-40B416	6036827	→ F-185
WFL120-60B416	6036834	→ F-185
WFL120-95B416	6036841	→ F-185
WFL15-40B416	6036823	→ F-184
WFL15-60B416	6036830	→ F-184
WFL15-95B416	6036837	→ F-184
WFL2-40B416	6036821	→ F-184
WFL2-60B416	6036828	→ F-184
WFL2-95B416	6036835	→ F-184
WFL30-40B416	6036824	→ F-184
WFL30-60B416	6036831	→ F-184
WFL30-95B416	6036838	→ F-184
WFL5-40B416	6036822	→ F-184
WFL5-60B416	6036829	→ F-184
WFL5-95B416	6036836	→ F-184
WFL50-40B416	6036825	→ F-184
WFL50-60B416	6036832	→ F-184
WFL50-95B416	6036839	→ F-184
WFL80-40B416	6036826	→ F-185
WFL80-60B416	6036833	→ F-185
WFL80-95B416	6036840	→ F-185
WFM120-120N311	6037835	→ F-190
WFM120-120N321	6037834	→ F-190
WFM120-120P311	6037833	→ F-190
WFM120-120P321	6037832	→ F-190
WFM180-120N311	6037839	→ F-191
WFM180-120N321	6037838	→ F-191
WFM180-120P311	6037837	→ F-191
WFM180-120P321	6037836	→ F-191
WFM30-40N311	6037822	→ F-190
WFM30-40N321	6037821	→ F-190
WFM30-40P121	6037823	→ F-190
WFM30-40P311	6037820	→ F-190
WFM30-40P321	6037819	→ F-190
WFM50-60N311	6037827	→ F-190
WFM50-60N321	6037826	→ F-190
WFM50-60P311	6037825	→ F-190
WFM50-60P321	6037824	→ F-190

Type	Part no.	Page
WFM80-60N311	6037831	→ F-190
WFM80-60N321	6037830	→ F-190
WFM80-60P311	6037829	→ F-190
WFM80-60P321	6037828	→ F-190
WFS3-40N415	6043920	→ F-166
WFS3-40N41C	6053766	→ F-166
WFS3-40P415	6043919	→ F-166
WFS3-40P41C	6053765	→ F-166





## SICK AT A GLANCE

SICK is a leading manufacturer of intelligent sensors and sensor solutions for industrial applications. With almost 7,000 employees and over 50 subsidiaries and equity investments as well as numerous representative offices worldwide, we are always close to our customers. A unique range of products and services creates the perfect basis for controlling processes securely and efficiently, protecting individuals from accidents and preventing damage to the environment.

We have extensive experience in various industries and understand their processes and requirements. With intelligent sensors, we can deliver exactly what our customers need. In application centers in Europe, Asia and North America, system solutions are tested and optimized in accordance with customer specifications. All this makes us a reliable supplier and development partner.

Comprehensive services round out our offering: SICK LifeTime Services provide support throughout the machine life cycle and ensure safety and productivity.

**For us, that is “Sensor Intelligence.”**

### **Worldwide presence:**

Australia, Austria, Belgium, Brazil, Canada, Chile, China, Czech Republic, Denmark, Finland, France, Germany, Great Britain, Hungary, India, Israel, Italy, Japan, Malaysia, Mexico, Netherlands, New Zealand, Norway, Poland, Romania, Russia, Singapore, Slovakia, Slovenia, South Africa, South Korea, Spain, Sweden, Switzerland, Taiwan, Thailand, Turkey, United Arab Emirates, USA, Vietnam.

Detailed addresses and additional representatives → [www.sick.com](http://www.sick.com)