

PSR-M-GW-CAN-SC - Data interface



1105104

<https://www.phoenixcontact.com/us/products/1105104>

Please be informed that the data shown in this PDF document is generated from our online catalog. Please find the complete data in the user documentation. Our general terms of use for downloads are valid.



Gateway for connecting a PSR-M base module to a higher-level controller, CANopen® , TBUS interface, plug-in screw terminal block, TBUS connector included

Product description

The configurable and individually scalable PSRmodular safety system is a flexible safety solution for monitoring your machine or system. PSRmodular gateways connect a PSR-M basic module to a higher-level controller. This gateway is intended for use with CANopen®.

Your advantages

- Cost-effective safety solution with a high level of adaptability to individual requirements
- Fast startup, thanks to easy hardware and software configuration
- Machine downtimes minimized with comprehensive, easy-to-understand diagnostics
- Narrow housing width of just 22.6 mm

Commercial data

Item number	1105104
Packing unit	1 pc
Minimum order quantity	1 pc
Sales key	DN02
Product key	DNA365
GTIN	4055626974996
Weight per piece (including packing)	170 g
Weight per piece (excluding packing)	131 g
Customs tariff number	85371098
Country of origin	IT

1105104

<https://www.phoenixcontact.com/us/products/1105104>

Technical data

Notes

Note on application	Only for industrial use
---------------------	-------------------------

Product properties

Product type	Gateways/Proxies
--------------	------------------

Data management status

Article revision	01
------------------	----

Insulation characteristics

Protection class	III (EN 50178)
------------------	----------------

Electrical properties

Maximum power dissipation for nominal condition	1 W
Nominal operating mode	100% operating factor
Interfaces	DIN rail TBUS for connection to the master module, supplied as standard

Air clearances and creepage distances between the power circuits

Rated insulation voltage	250 V AC
Rated surge voltage/insulation	Basic insulation 4 kV

Supply

Designation	A1/A2
Rated control circuit supply voltage U_S	19.2 V DC ... 28.8 V DC
Rated control circuit supply voltage U_S	24 V DC -20 % / +20 % (external fuse, typically 4 A)
Rated control supply current I_S	typ. 35 mA (without network connection) typ. 40 mA (with network connection)
Power consumption at U_S	typ. 1 W (with network connection)
Inrush current	< 2.2 A ($\Delta t = 1$ ms at U_S)
Filter time	typ. 5 ms (in the event of voltage dips at U_S)
Protective circuit	Serial protection against polarity reversal Suppressor diode

Connection data

Connection method	Screw connection
Stripping length	7 mm
Tightening torque	0.5 ... 0.6 Nm
Screw thread	M3

Interfaces

Data: Network interface

Communication protocol	CANopen®
------------------------	----------

PSR-M-GW-CAN-SC - Data interface



1105104

<https://www.phoenixcontact.com/us/products/1105104>

Connection method	D-SUB-9 female connector
Number of connections	1
Transmission speed	1 Mbps

Data: Service interface

Connection method	USB 2.0 Hi-Speed
Number of connections	1

Signaling

Status display	1 x LED (green), 1 x LED (green, red), 1 x LED (red)
Operating voltage display	1 x green LED
Error indication	2 x LED (red)

Dimensions

Width	22.61 mm
Height	112.58 mm
Depth	115.95 mm

Material specifications

Color (Housing)	gray (RAL 7042)
Housing material	Polyamide PA non-reinforced

Environmental and real-life conditions

Ambient conditions

Degree of protection	IP20
Min. degree of protection of inst. location	IP54
Ambient temperature (operation)	-10 °C ... 55 °C (observe derating)
Ambient temperature (storage/transport)	-20 °C ... 85 °C
Maximum altitude	≤ 2000 m (Above sea level)
Max. permissible humidity (storage/transport)	95 % (non-condensing)
Max. permissible relative humidity (operation)	95 % (non-condensing)
Shock	10g for $\Delta t = 16$ ms (continuous shock, 1000 shocks in each space direction)
Vibration (operation)	10 Hz ... 150 Hz, 2g

Approvals

CE

Identification	CE-compliant
----------------	--------------

Mounting

Mounting type	DIN rail mounting
Mounting position	vertical or horizontal

PSR-M-GW-CAN-SC - Data interface



1105104

<https://www.phoenixcontact.com/us/products/1105104>

Drawings

Block diagram

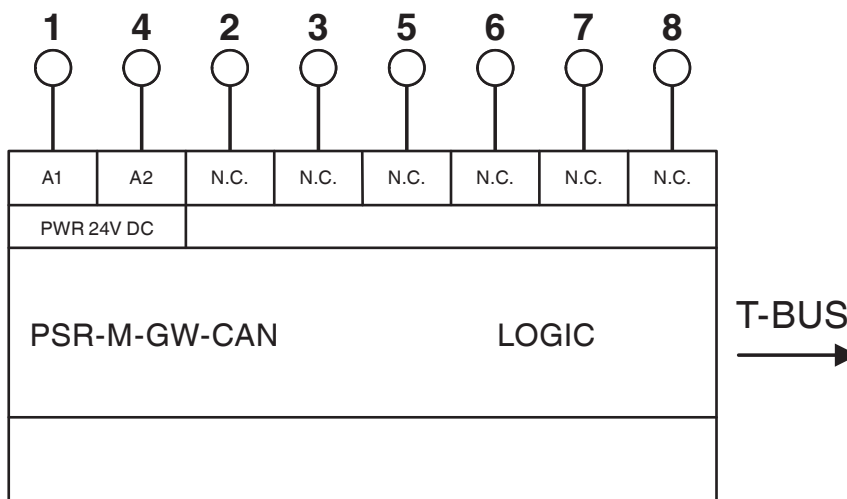

Application drawing

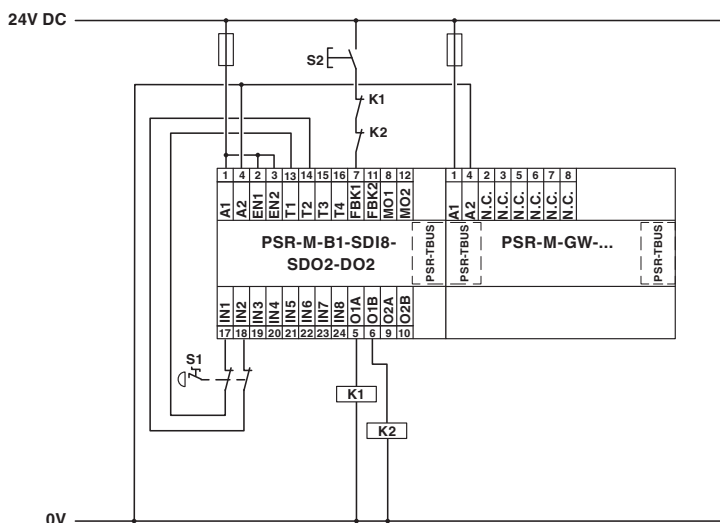



1105104

<https://www.phoenixcontact.com/us/products/1105104>

Approvals

 To download certificates, visit the product detail page: <https://www.phoenixcontact.com/us/products/1105104>

 **UL Listed**
Approval ID: FILE E 238705

 **cUL Listed**
Approval ID: FILE E 238705

 **EAC**
Approval ID: RU*-DE*B.00606/20

 **Functional Safety**
Approval ID: Z10 029429 0013

cULus Listed

1105104

<https://www.phoenixcontact.com/us/products/1105104>

Classifications

ECLASS

ECLASS-11.0	27242608
ECLASS-12.0	27242608
ECLASS-13.0	27242608

ETIM

ETIM 9.0	EC001604
----------	----------

UNSPSC

UNSPSC 21.0	32151600
-------------	----------

1105104

<https://www.phoenixcontact.com/us/products/1105104>

Environmental product compliance

EU RoHS

Fulfills EU RoHS substance requirements	Yes, No exemptions
---	--------------------

China RoHS

Environment friendly use period (EFUP)	EFUP-E
	No hazardous substances above the limits

EU REACH SVHC

REACH candidate substance (CAS No.)	No substance above 0.1 wt%
-------------------------------------	----------------------------

PSR-M-GW-CAN-SC - Data interface



1105104

<https://www.phoenixcontact.com/us/products/1105104>

Accessories

PSR-M-B1-SDI8-SDO2-DO2-SC - Safety module

1104981

<https://www.phoenixcontact.com/us/products/1104981>



Configurable safety module (basic module), 8 safe inputs, 2 safe outputs, 2 reset inputs, 2 signal outputs, 4 clock outputs, can be extended via TBUS, up to SIL 3, Cat. 4/PL e, plug-in screw terminal block, TBUS connector not included

PSR-M-B1-SDI8-SDO2-DO2-PI - Safety module

1104972

<https://www.phoenixcontact.com/us/products/1104972>



Configurable safety module (basic module), 8 safe inputs, 2 safe outputs, 2 reset inputs, 2 signal outputs, 4 clock outputs, can be extended via TBUS, up to SIL 3, Cat. 4/PL e, plug-in Push-in terminal block, TBUS connector not included

PSR-M-GW-CAN-SC - Data interface

1105104

<https://www.phoenixcontact.com/us/products/1105104>

PSR-M-B2-SDI8-SDO4-DO4-SC - Safety module

1104974

<https://www.phoenixcontact.com/us/products/1104974>



Configurable safety module (basic module), 8 safe inputs, 4 safe outputs, 4 reset inputs or 4 signal outputs, 4 clock outputs, can be extended via TBUS, up to SIL 3, Cat. 4/PL e, plug-in screw terminal block, TBUS connector not included

PSR-M-B2-SDI8-SDO4-DO4-PI - Safety module

1104975

<https://www.phoenixcontact.com/us/products/1104975>



Configurable safety module (basic module), 8 safe inputs, 4 safe outputs, 4 reset inputs or 4 signal outputs, 4 clock outputs, can be extended via TBUS, up to SIL 3, Cat. 4/PL e, plug-in Push-in terminal block, TBUS connector not included

PSR-M-GW-CAN-SC - Data interface



1105104

<https://www.phoenixcontact.com/us/products/1105104>

CABLE-USB/MINI-USB-3,0M - USB cable

2986135

<https://www.phoenixcontact.com/us/products/2986135>

USB connecting cable: USB plug type A to USB plug type Mini-B; length: 3 m



CP-MSTB - Coding profile

1734634

<https://www.phoenixcontact.com/us/products/1734634>

Coding profile, is inserted into the slot on the plug or inverted header, red insulating material



PSR-M-GW-CAN-SC - Data interface



1105104

<https://www.phoenixcontact.com/us/products/1105104>

CR-MSTB - Coding section

1734401

<https://www.phoenixcontact.com/us/products/1734401>

Coding section, inserted into the recess in the header or the inverted plug, red insulating material



CRIMPFOX 6 - Crimping pliers

1212034

<https://www.phoenixcontact.com/us/products/1212034>

Crimping pliers, for ferrules without insulating collar according to DIN 46228 Part 1 and ferrules with insulating collar according to DIN 46228 Part 4, 0.25 mm² ... 6.0 mm², lateral entry, trapezoidal crimp



Phoenix Contact 2024 © - all rights reserved
<https://www.phoenixcontact.com>

Phoenix Contact USA
586 Fulling Mill Road
Middletown, PA 17057, United States
(+717) 944-1300
info@phoenixcon.com