

3-MODE 300mA LDO REGULATOR

NO.EA-106-140530

OUTLINE

The R1161x Series are CMOS-based voltage regulator ICs with high output voltage accuracy, low supply current, and low ON-resistance. Each of these voltage regulator ICs consists of a voltage reference unit, an error amplifier, resistors for setting output voltage, a current limit circuit, and a chip enable circuit.

These ICs perform with low dropout voltage and a chip enable function. To prevent the destruction by over current, current limit circuit is included. The R1161x Series have 3-mode. One is standby mode with CE or standby control pin. Standby mode realizes ultra small consumption current off mode. Other two modes are realized with ECO pin. Fast Transient Mode (FT mode) and Low Power Mode (LP mode) are alternative with ECO pin. Consumption current is reduced at Low Power Mode compared with Fast Transient Mode. Output voltage is maintained between FT mode and LP mode.

The output voltage of these ICs is internally fixed with high accuracy. Since the packages for these ICs are SOT-23-5, SON-6, and HSON-6, high density mounting of the ICs on boards is possible.

FEATURES

- Supply Current Typ. 3.5 μ A (Low Power Mode, $V_{OUT}<1.6V$),
Typ. 80 μ A (Fast Transient Mode, $V_{OUT}<1.8V$)
Typ. 60 μ A (Fast Transient Mode, $V_{OUT} \geq 1.8V$)
- Standby Mode Typ. 0.1 μ A
- Dropout Voltage Typ. 0.48V ($I_{OUT}=300mA$ Output Voltage=1.0V Type)
Typ. 0.31V ($I_{OUT}=300mA$ Output Voltage=1.5V Type)
Typ. 0.23V ($I_{OUT}=300mA$ Output Voltage=3.0V Type)
- Ripple Rejection Typ. 65dB ($f=1kHz$, FT Mode)
- Temperature-Drift Coefficient of Output Voltage Typ. $\pm 100ppm/^{\circ}C$
- Line Regulation Typ. 0.01%/V (at Fast Transient Mode)
- Output Voltage Accuracy $\pm 2.0\%$ ($\pm 3.0\%$ at LP Mode)
- Packages SOT-23-5, SON-6,
HSON-6
- Output Voltage 0.8V to 3.3V (0.1V steps)
(For other voltages, please refer to MARK INFORMATIONS.)
- Input Voltage Min. 1.40V ($V_{OUT} \geq 1.0V$)
Min. 1.45V ($V_{OUT}<1.0V$)
- Built-in fold-back protection circuit Typ. 50mA (Current at short mode)
- External Capacitors $C_{IN} = C_{OUT} =$ Tantalum 1.0 μ F ($V_{OUT}<1.0V$)
 $C_{IN} = C_{OUT} =$ Ceramic 1.0 μ F ($V_{OUT} \geq 1.0V$)

APPLICATIONS

- Precision Voltage References.
- Power source for electrical appliances such as cameras, VCRs and hand-held communication equipment.
- Power source for battery-powered equipment.

R1161x

BLOCK DIAGRAM

R1161xxxxA

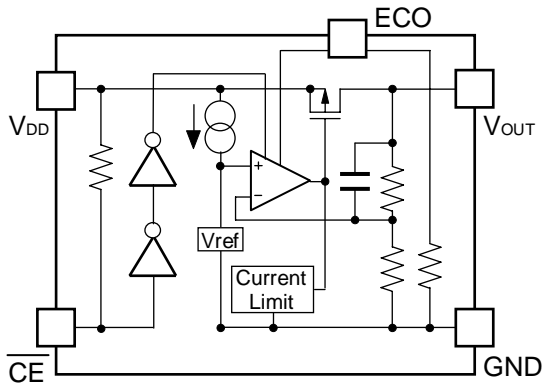

R1161xxxxB

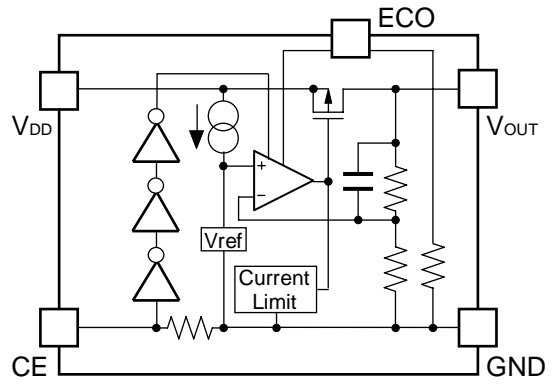

R1161xxxxD

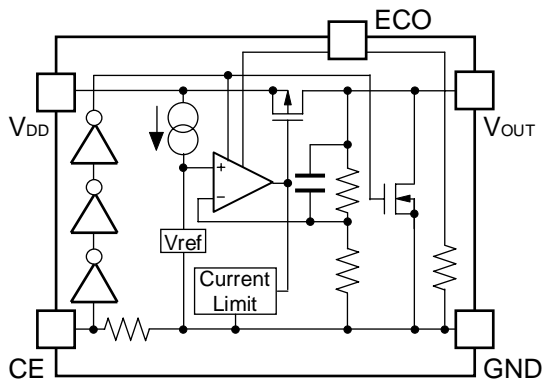

SELECTION GUIDE

The output voltage, chip enable polarity, auto discharge function, and package, etc. for the ICs can be selected at the user's request.

Product Name	Package	Quantity per Reel	Pb Free	Halogen Free
R1161Nxx1*-TR-FE	SOT-23-5	3,000 pcs	Yes	Yes
R1161Dxx1*-TR-FE	SON-6	3,000 pcs	Yes	Yes
R1161Dxx2*-TR-FE	HSON-6	3,000 pcs	Yes	Yes

xx: The output voltage can be designated in the range from 0.8V(08) to 3.3V(33) in 0.1V steps.
(For other voltages, please refer to MARK INFORMATIONS.)

* : CE pin polarity and auto discharge function at off state are options as follows.

- (A) "L" active type, without auto discharge function at off state
- (B) "H" active type, without auto discharge function at off state
- (D) "H" active type, with auto discharge function at off state

R11161x

PIN CONFIGURATIONS

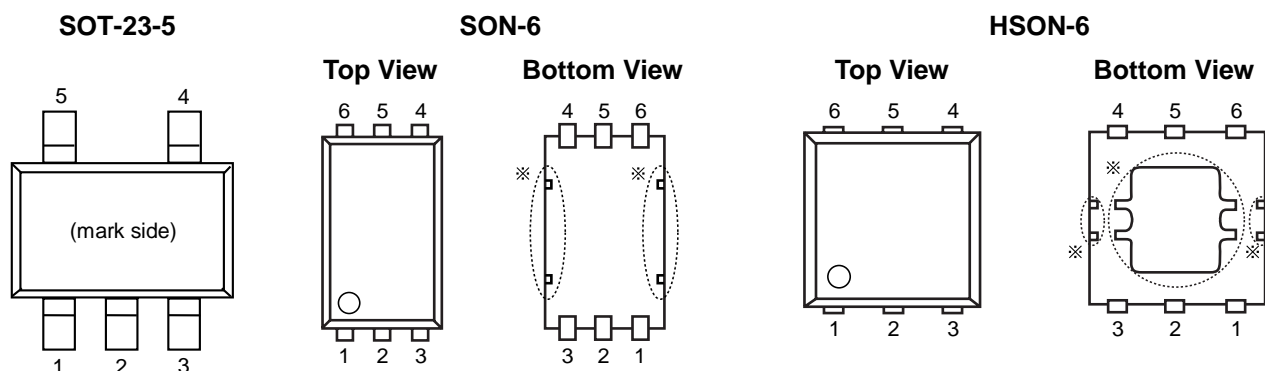

PIN DESCRIPTIONS

• SOT-23-5

Pin No.	Symbol	Description
1	V_{DD}	Input Pin
2	GND	Ground Pin
3	\overline{CE} or CE	Chip Enable Pin
4	ECO	MODE alternative pin
5	V_{OUT}	Output pin

• SON-6, HSON-6

Pin No.	Symbol	Description
1	V_{DD}	Input Pin
2	NC	No Connection
3	V_{OUT}	Output pin
4	ECO	MODE alternative pin
5	GND	Ground Pin
6	\overline{CE} or CE	Chip Enable Pin

*) Tab and tab suspension leads are GND level. (They are connected to the reverse side of the IC.)

The tab is better to be connected to the GND, but leaving it open is also acceptable.

The tab suspension leads should be open and do not connect to other wires or land patterns.

ABSOLUTE MAXIMUM RATINGS

Symbol	Item	Rating	Unit
V _{IN}	Input Voltage	6.5	V
V _{ECO}	Input Voltage (ECO Pin)	-0.3 ~ 6.5	V
V _{CE}	Input Voltage (\overline{CE} /CE Pin)	-0.3 ~ 6.5	V
V _{OUT}	Output Voltage	-0.3 ~ V _{IN} +0.3	V
I _{OUT}	Output Current	350	mA
P _D	Power Dissipation (SOT23-5)*	420	mW
P _D	Power Dissipation (SON-6) *	500	
P _D	Power Dissipation (HSO6) *	900	
T _{opt}	Operating Temperature Range	-40 ~ 85	°C
T _{stg}	Storage Temperature Range	-55 ~ 125	°C

*) For Power Dissipation, please refer to PACKAGE INFORMATION.

ABSOLUTE MAXIMUM RATINGS

Electronic and mechanical stress momentarily exceeded absolute maximum ratings may cause the permanent damages and may degrade the life time and safety for both device and system using the device in the field.

The functional operation at or over these absolute maximum ratings is not assured.

RECOMMENDED OPERATING CONDITIONS (ELECTRICAL CHARACTERISTICS)

All of electronic equipment should be designed that the mounted semiconductor devices operate within the recommended operating conditions. The semiconductor devices cannot operate normally over the recommended operating conditions, even if when they are used over such conditions by momentary electronic noise or surge. And the semiconductor devices may receive serious damage when they continue to operate over the recommended operating conditions.

R1161x

ELECTRICAL CHARACTERISTICS

• R1161xxxxA

T_{opt}=25°C

Symbol	Item	Conditions	Min.	Typ.	Max.	Unit
V _{OUT}	Output Voltage (FT Mode)	V _{IN} =Set V _{OUT} +1V, V _{ECO} =V _{IN} 1μA ≤ I _{OUT} ≤ 30mA ^{Note 1}	×0.98 (-30mV)		×1.02 (30mV)	V
	Output Voltage (LP Mode)	V _{IN} =Set V _{OUT} +1V, V _{ECO} =GND 1μA ≤ I _{OUT} ≤ 30mA ^{Note 2}	×0.97 (-45mV)		×1.03 (45mV)	V
I _{OUT}	Output Current	V _{IN} -V _{OUT} =1.0V	300			mA
ΔV _{OUT} / ΔI _{OUT}	Load Regulation (FT Mode)	V _{IN} =Set V _{OUT} +1V, V _{ECO} =V _{IN} 1mA ≤ I _{OUT} ≤ 300mA		40	70	mV
ΔV _{OUT} / ΔI _{OUT}	Load Regulation (LP Mode)	V _{IN} =Set V _{OUT} +1V, V _{ECO} =GND 1mA ≤ I _{OUT} ≤ 100mA		15	30	mV
V _{DIF}	Dropout Voltage	Refer to the ELECTRICAL CHARACTERISTICS by OUTPUT VOLTAGE				
I _{SS1}	Supply Current (FT Mode)	V _{IN} =Set V _{OUT} +1V V _{ECO} =V _{IN} , V _{OUT} <1.8V		80	111	μA
		V _{IN} =Set V _{OUT} +1V V _{ECO} =V _{IN} , V _{OUT} ≥ 1.8V		60	90	μA
I _{SS2}	Supply Current (LP Mode)	V _{IN} =Set V _{OUT} +1V, V _{OUT} <1.6V, V _{ECO} =GND		3.5	8.0	μA
		V _{IN} =Set V _{OUT} +1V V _{OUT} ≥ 1.6V, V _{ECO} =GND		4.5	9.0	μA
I _{standby}	Supply Current (Standby)	V _{IN} =V _{CE} =Set V _{OUT} +1V, V _{ECO} =GND or V _{IN}		0.1	1.0	μA
ΔV _{OUT} / ΔV _{IN}	Line Regulation (FT Mode)	Set V _{OUT} +0.5V ≤ V _{IN} ≤ 6.0V I _{OUT} =30mA, V _{ECO} =V _{IN} Set V _{OUT} ≤ 0.9V: 1.4V ≤ V _{IN} ≤ 6.0V		0.01	0.15	%/V
ΔV _{OUT} / ΔV _{IN}	Line Regulation (LP Mode)	Set V _{OUT} +0.5V ≤ V _{IN} ≤ 6.0V I _{OUT} =30mA, V _{ECO} =GND Set V _{OUT} ≤ 0.9V: 1.4V ≤ V _{IN} ≤ 6.0V		0.05	0.20	%/V
RR	Ripple Rejection (FT Mode)	f = 1kHz, Ripple 0.2Vp-p V _{IN} =Set V _{OUT} +1V I _{OUT} =30mA, V _{ECO} =V _{IN}		65		dB
V _{IN}	Input Voltage		1.4		6.0	V
ΔV _{OUT} / ΔT _{opt}	Output Voltage Temperature Coefficient	I _{OUT} =30mA -40°C ≤ T _{opt} ≤ 85°C		±100		ppm /°C
I _{lim}	Short Current Limit	V _{OUT} =0V		50		mA
R _{PU}	\overline{CE} Pull-up Resistance		1.87	5.00	12.00	MΩ
R _{PD}	ECO Pull-down Resistance		1.87	5.00	12.00	MΩ
V _{CEH}	\overline{CE} , ECO Input Voltage "H"		1.0		6.0	V
V _{CEL}	\overline{CE} , ECO Input Voltage "L"		0.0		0.3	V
V _{EN}	Output Noise	BW=10Hz to 100kHz		30		μVrms

Note1: ±30mV tolerance for V_{OUT} ≤ 1.5V.

Note2: ±45mV tolerance for V_{OUT} ≤ 1.5V.

● R1161xxxxB/D

T_{opt}=25°C

Symbol	Item	Conditions	Min.	Typ.	Max.	Unit
V _{OUT}	Output Voltage (FT Mode)	V _{IN} =Set V _{OUT} +1V, V _{ECO} =V _{IN} 1μA ≤ I _{OUT} ≤ 30mA ^{Note 1}	×0.98 (-30mV)		×1.02 (30mV)	V
	Output Voltage (LP Mode)	V _{IN} =Set V _{OUT} +1V, V _{ECO} =GND 1μA ≤ I _{OUT} ≤ 30mA ^{Note 2}	×0.97 (-45mV)		×1.03 (45mV)	V
I _{OUT}	Output Current	V _{IN} -V _{OUT} =1.0V	300			mA
ΔV _{OUT} / ΔI _{OUT}	Load Regulation (FT Mode)	V _{IN} =Set V _{OUT} +1V, V _{ECO} =V _{IN} 1mA ≤ I _{OUT} ≤ 300mA		40	70	mV
ΔV _{OUT} / ΔI _{OUT}	Load Regulation (LP Mode)	V _{IN} =Set V _{OUT} +1V, V _{ECO} =GND 1mA ≤ I _{OUT} ≤ 100mA		15	30	mV
V _{DIF}	Dropout Voltage	Refer to the ELECTRICAL CHARACTERISTICS by OUTPUT VOLTAGE				
I _{SS1}	Supply Current (FT Mode)	V _{IN} =Set V _{OUT} +1V V _{ECO} =V _{IN} , V _{OUT} <1.8V		80	111	μA
		V _{IN} =Set V _{OUT} +1V V _{ECO} =V _{IN} , V _{OUT} ≥ 1.8V		60	90	μA
I _{SS2}	Supply Current (LP Mode)	V _{IN} =Set V _{OUT} +1V, V _{OUT} <1.6V, V _{ECO} =GND		3.5	8.0	μA
		V _{IN} =Set V _{OUT} +1V, V _{OUT} ≥ 1.6V, V _{ECO} =GND		4.5	9.0	μA
I _{standby}	Supply Current (Standby)	V _{IN} =Set V _{OUT} +1V, V _{CE} =GND, V _{ECO} =GND or V _{IN}		0.1	1.0	μA
ΔV _{OUT} / ΔV _{IN}	Line Regulation (FT Mode)	Set V _{OUT} +0.5V ≤ V _{IN} ≤ 6.0V I _{OUT} =30mA, V _{ECO} =V _{IN} Set V _{OUT} ≤ 0.9V: 1.4V ≤ V _{IN} ≤ 6.0V		0.01	0.15	%/V
ΔV _{OUT} / ΔV _{IN}	Line Regulation (LP Mode)	Set V _{OUT} +0.5V ≤ V _{IN} ≤ 6.0V I _{OUT} =30mA, V _{ECO} =GND Set V _{OUT} ≤ 0.9V: 1.4V ≤ V _{IN} ≤ 6.0V		0.05	0.20	%/V
RR	Ripple Rejection (FT Mode)	f=1kHz, Ripple 0.2Vp-p V _{IN} =Set V _{OUT} +1V I _{OUT} =30mA, V _{ECO} =V _{IN}		65		dB
V _{IN}	Input Voltage		1.4		6.0	V
ΔV _{OUT} / ΔT _{opt}	Output Voltage Temperature Coefficient	I _{OUT} =30mA -40°C ≤ T _{opt} ≤ 85°C		±100		ppm /°C
I _{lim}	Short Current Limit	V _{OUT} =0V		50		mA
R _{PDC}	CE Pull-down Resistance		1.87	5.00	12.00	MΩ
R _{PDE}	ECO Pull-down Resistance		1.87	5.00	12.00	MΩ
V _{CEH}	CE, ECO Input Voltage "H"		1.0		6.0	V
V _{CEL}	CE, ECO Input Voltage "L"		0.0		0.3	V
V _{EN}	Output Noise	BW=10Hz to 100kHz		30		μV _{rms}
R _{LOW}	Nch On Resistance for auto discharge (applied to D version only)	V _{CE} =0V		60		Ω

Note1: ±30mV tolerance for V_{OUT} ≤ 1.5V.

Note2: ±45mV tolerance for V_{OUT} ≤ 1.5V.

* R1116Dxx1 (SON-6) and R1116Dxx2 (HSO6) products are the discontinued product. As of March in 2018.

R1161x

ELECTRICAL CHARACTERISTICS by OUTPUT VOLTAGE

$T_{opt}=25^{\circ}C$

Output Voltage V_{OUT} (V)	Dropout Voltage V_{DIF} (V)				
	Condition	V_{DIF} (ECO=H)		V_{DIF} (ECO=L)	
		Typ.	Max.	Typ.	Max.
$0.8=V_{OUT}$	$I_{OUT}=300mA$	0.620	0.850	0.670	0.900
$0.9=V_{OUT}$		0.550	0.780	0.590	0.800
$1.0 \leq V_{OUT} < 1.5$		0.480	0.700	0.510	0.750
$1.5 \leq V_{OUT} < 2.6$		0.310	0.450	0.320	0.480
$2.6 \leq V_{OUT} \leq 3.3$		0.230	0.350	0.240	0.375

TEST CIRCUITS

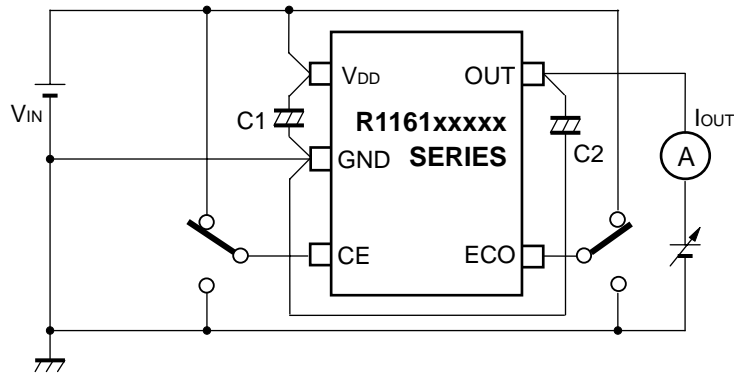

Fig.1 Output Voltage vs. Output Current Test Circuit

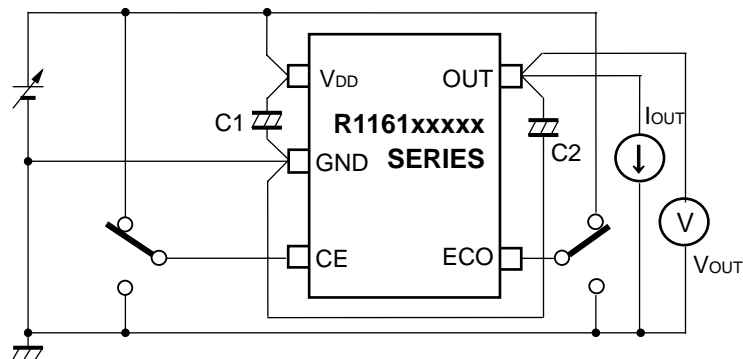

Fig.2 Output Voltage vs. Input Voltage Test Circuit

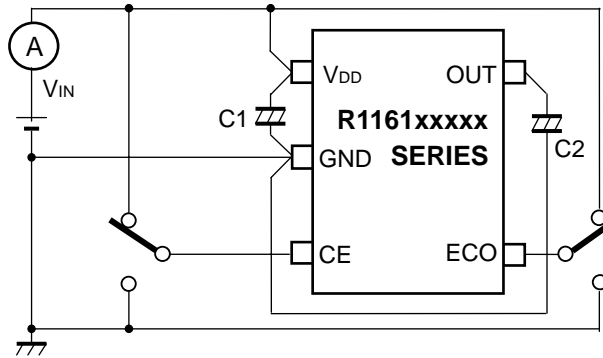

Fig.3 Supply Current vs. Input Voltage Test Circuit

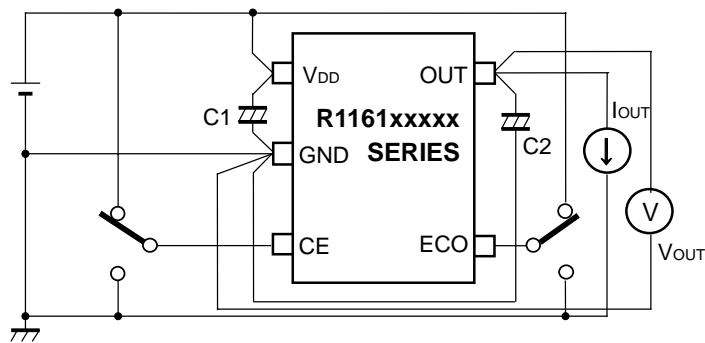

Fig.4 Output Voltage vs. Temperature Test Circuit

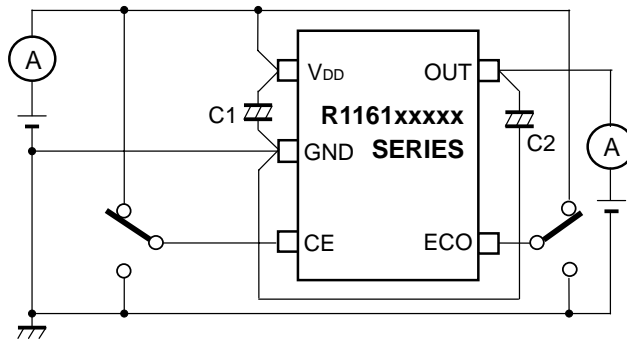

Fig.5 Supply Current vs. Temperature Test Circuit

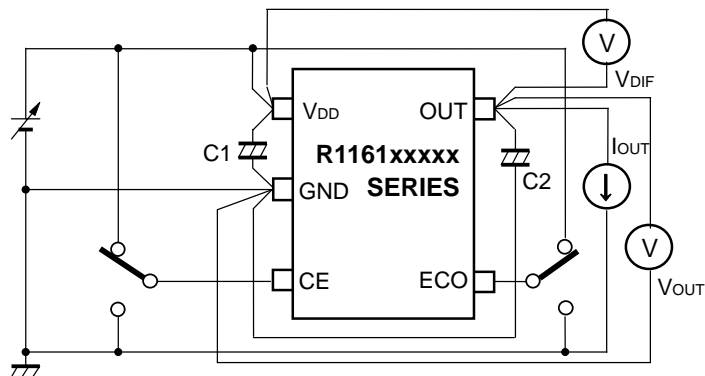

Fig. 6 Dropout Voltage vs. Output Current/ Set Output Voltage Test Circuit

R1161x

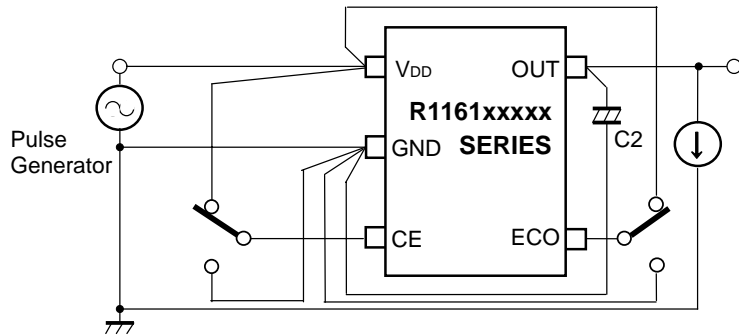

Fig. 7 Ripple Rejection Test Circuit

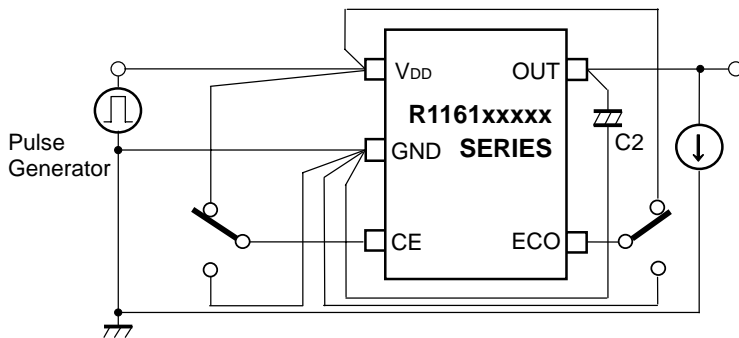

Fig.8 Input Transient Response Test Circuit

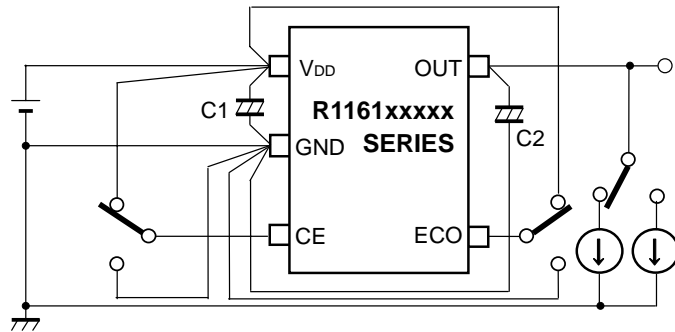

Fig.9 Load Transient Response Test Circuit

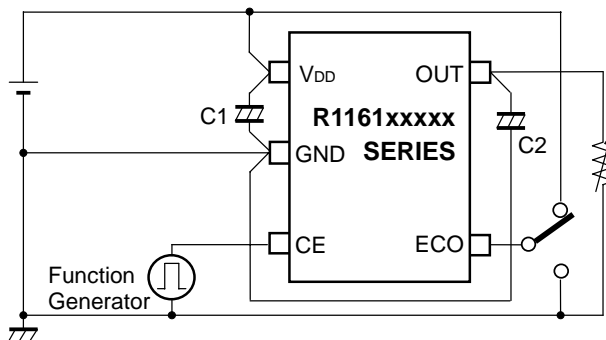

Fig.10 Turn on Speed with CE pin Test Circuit

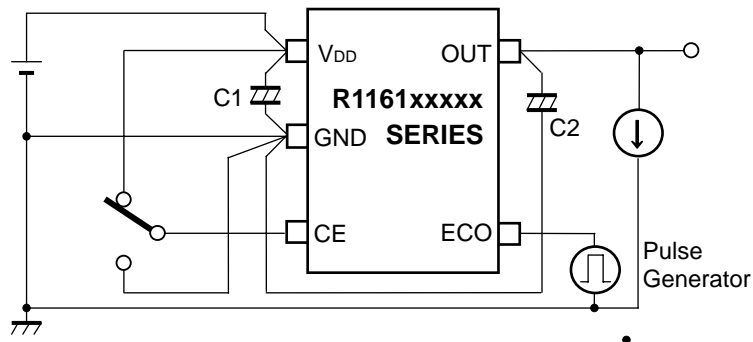

Fig.11 MODE Transient Response Test Circuit

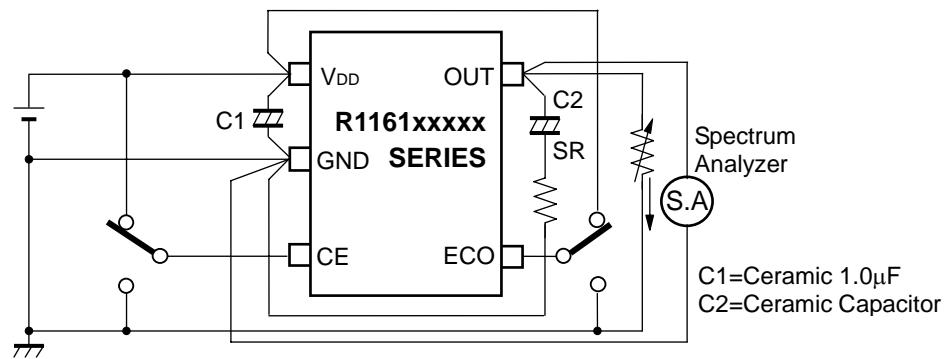
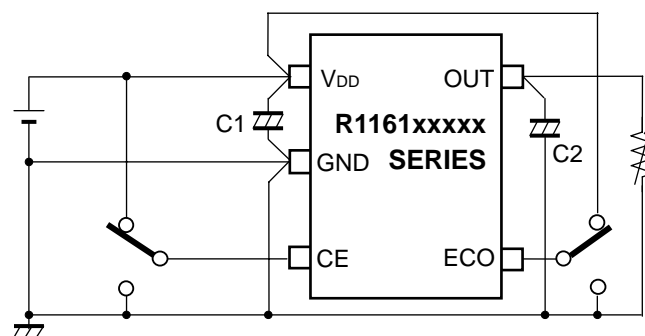

Fig.12 Output Noise Test Circuit(I_{OUT} vs. ESR)

TYPICAL APPLICATION



(External Components)

Output Capacitor; 1.0 μ F or more capacity ceramic Type (If V_{OUT}<1.0V, Tantalum type is recommended)

Input Capacitor; 1.0 μ F or more capacity ceramic Type

R1161x

TYPICAL CHARACTERISTICS

1) Output Voltage vs. Output Current

R1161x08xx (ECO=H)

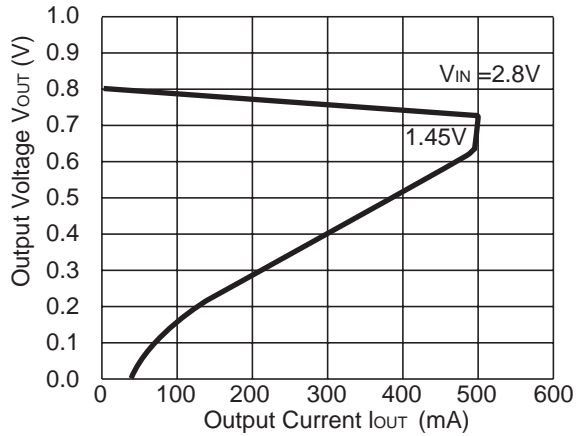

R1161x08xx (ECO=L)

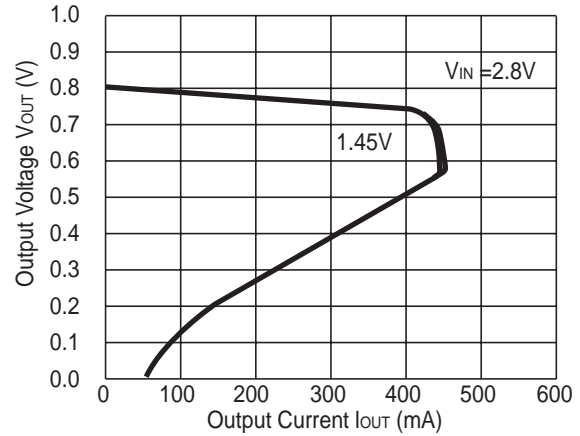

R1161x15xx (ECO=H)

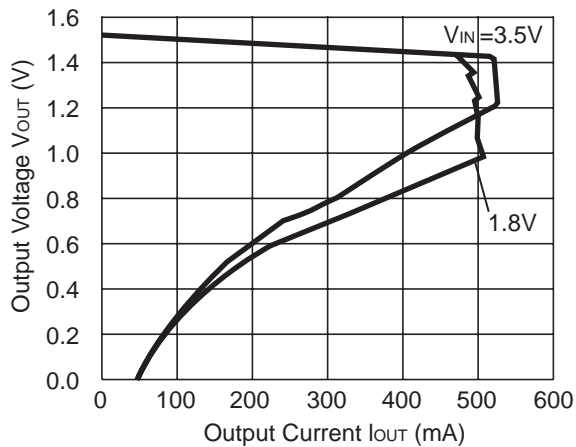

R1161x15xx (ECO=L)

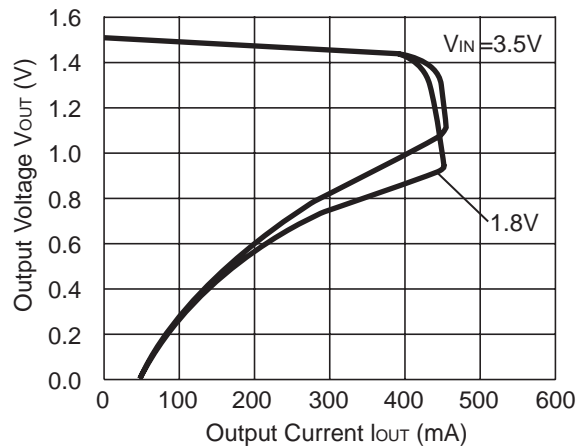

R1161x26xx (ECO=H)

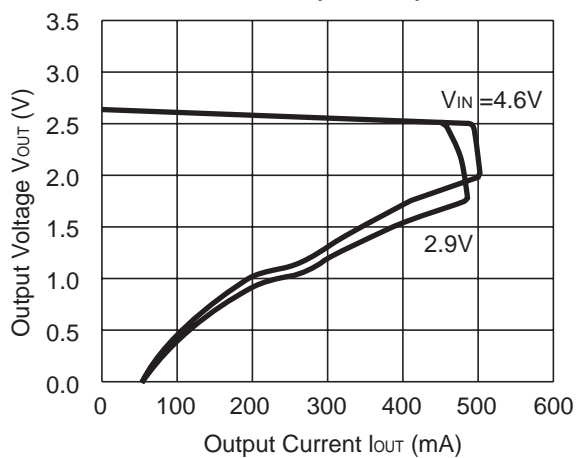

R1161x26xx (ECO=L)

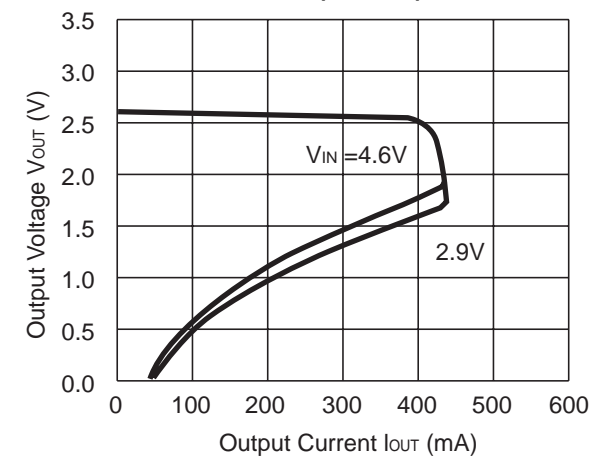

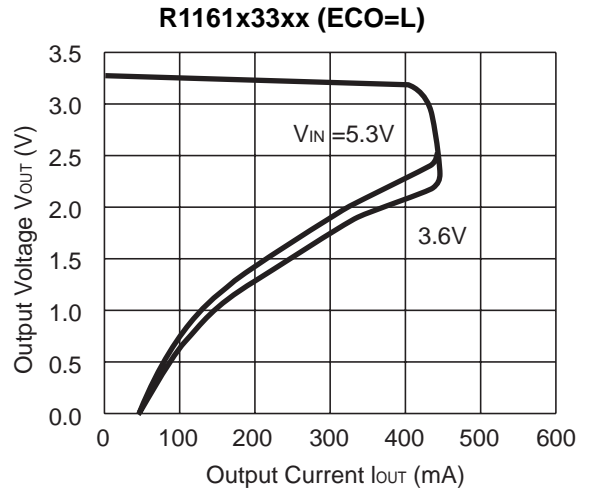
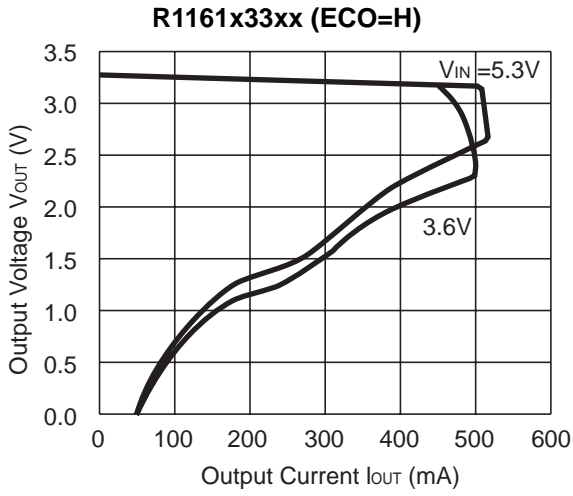

2) Output Voltage vs. Input Voltage

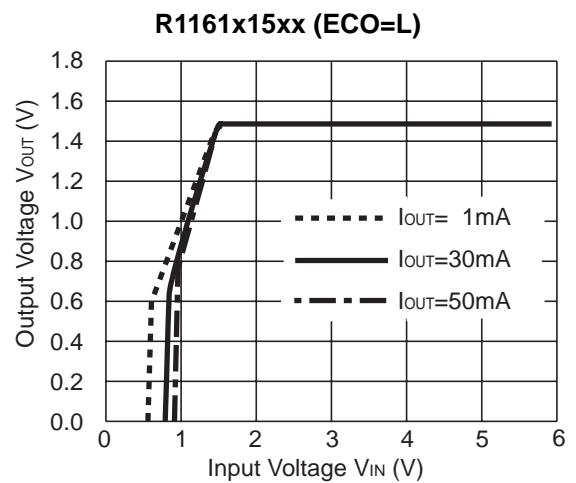
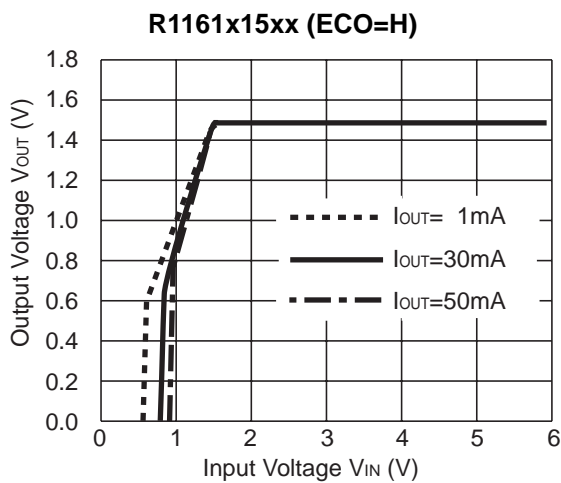
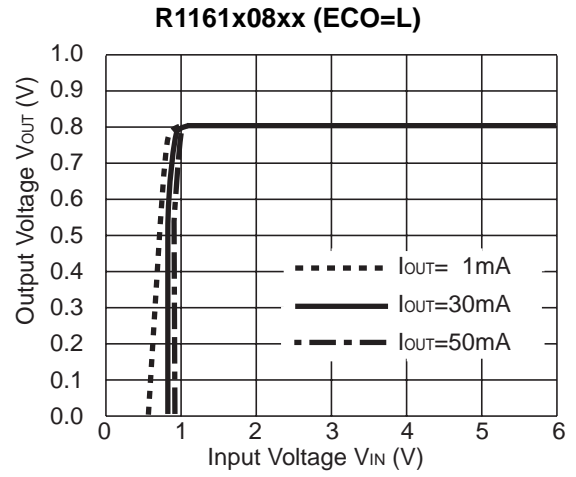
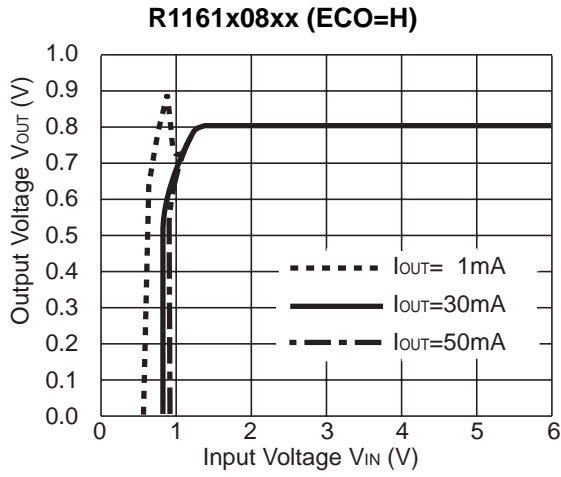

R1161x

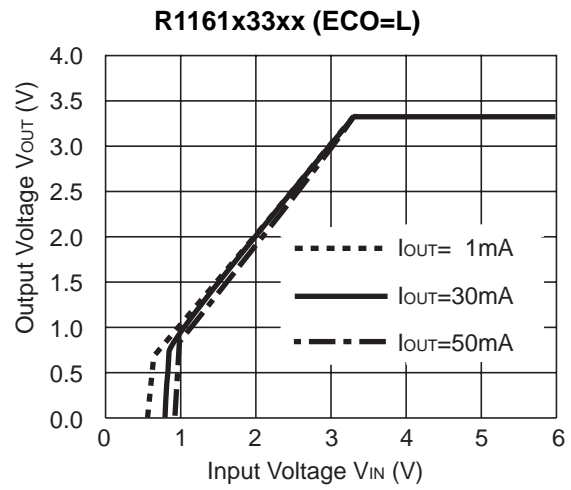
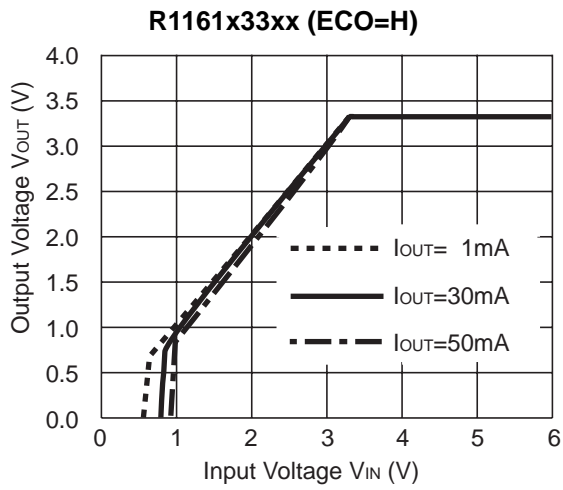
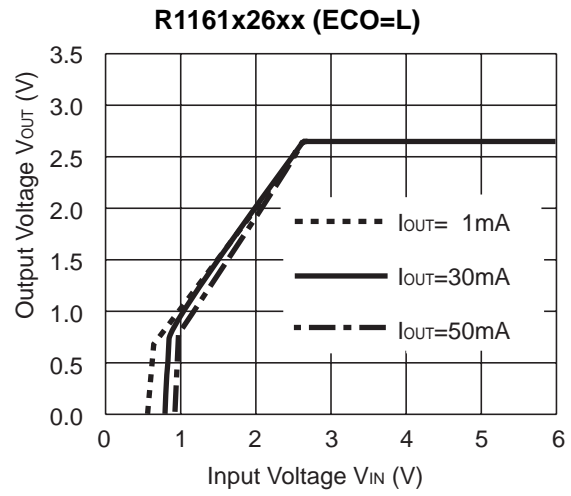
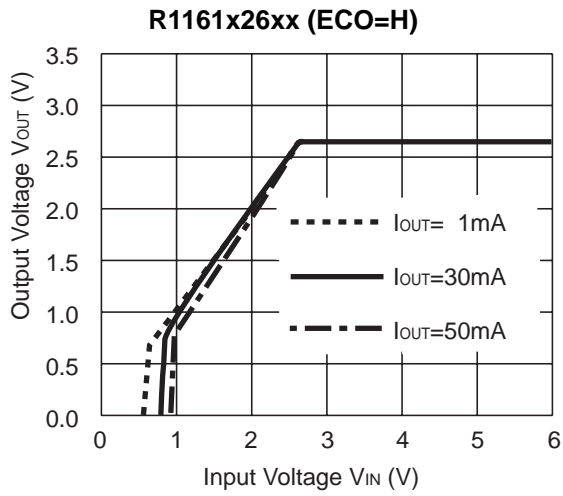

3) Supply Current vs. Input Voltage

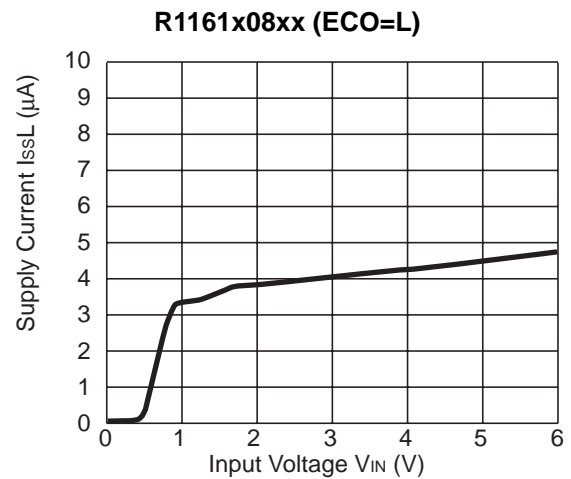
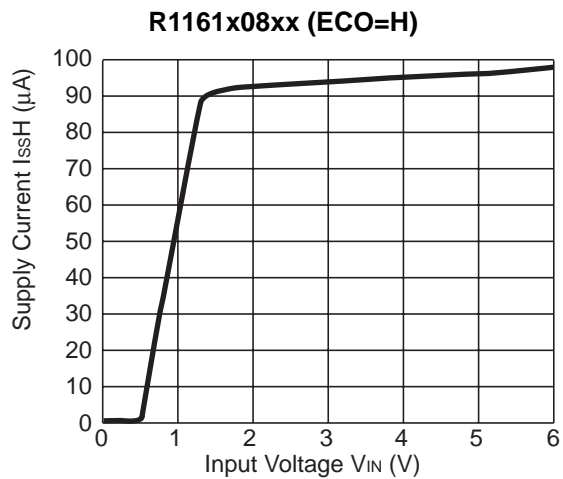

R1161x15xx (ECO=H)

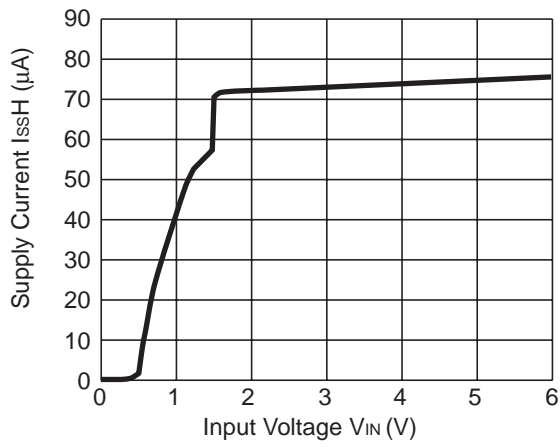

R1161x15xx (ECO=L)

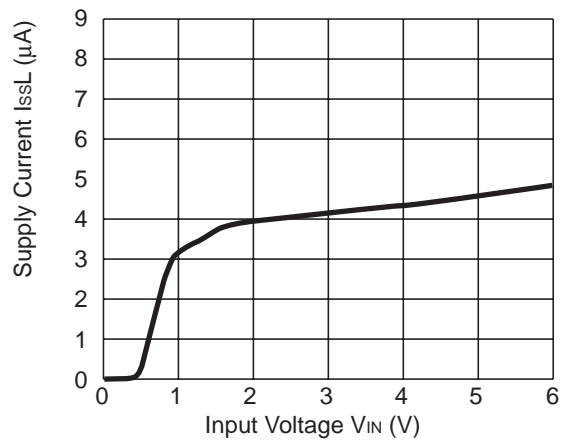

R1161x26xx (ECO=H)

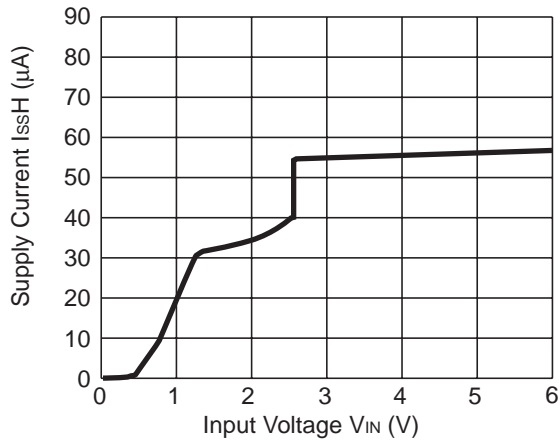

R1161x26xx (ECO=L)

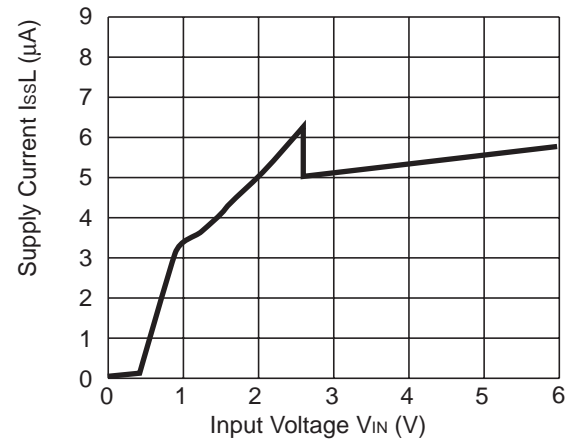

R1161x33xx (ECO=H)

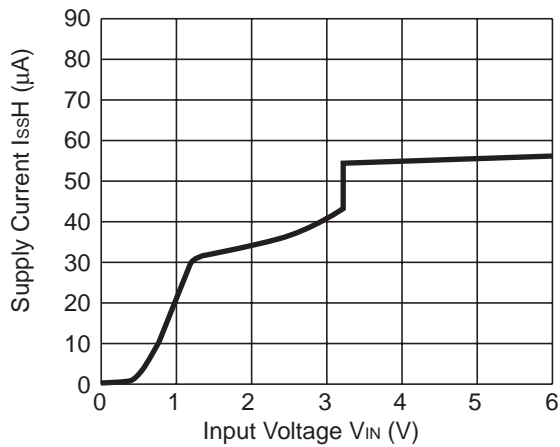

R1161x33xx (ECO=L)

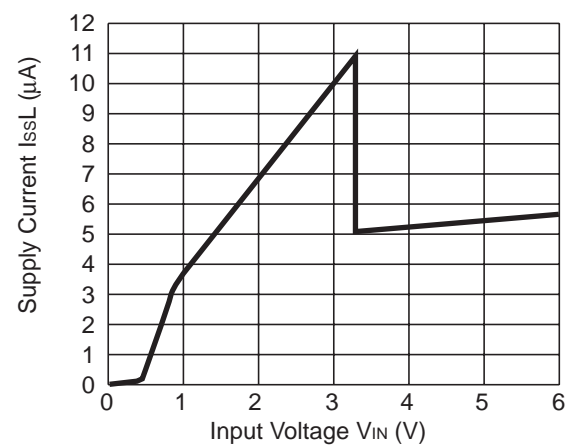

R1161x

4) Output Voltage vs. Temperature

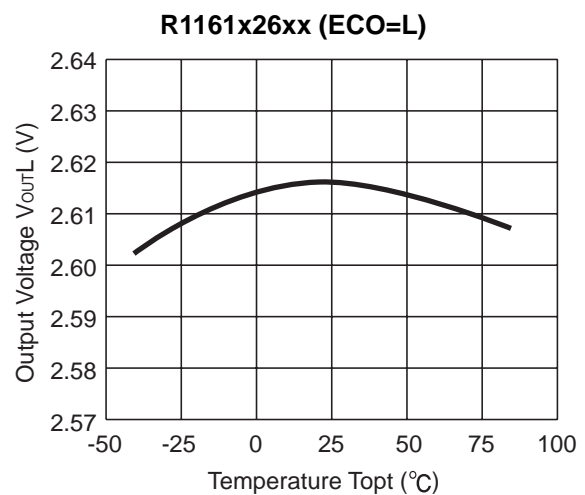
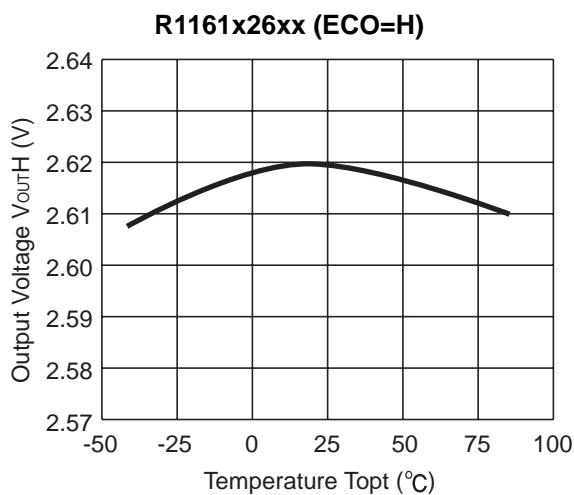
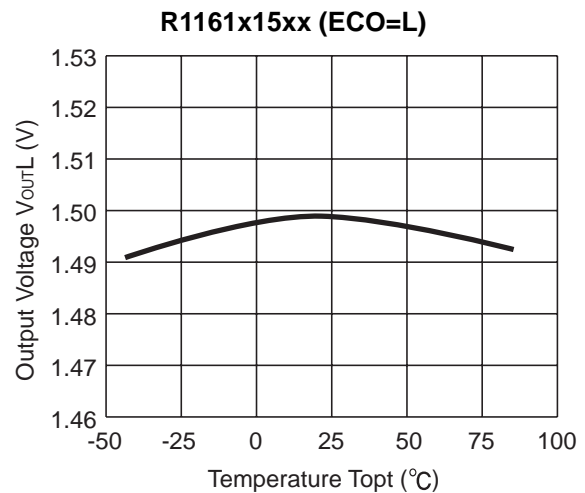
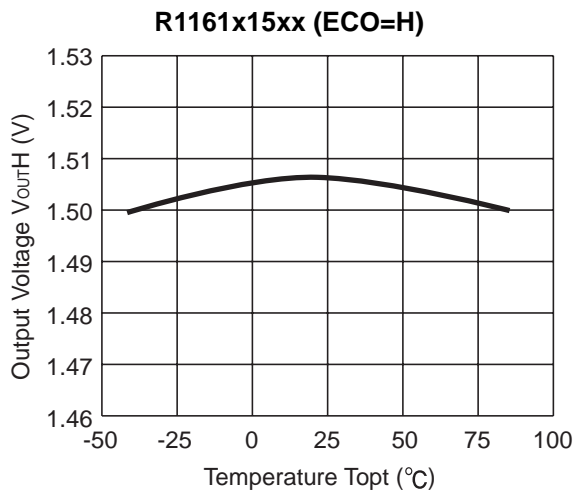
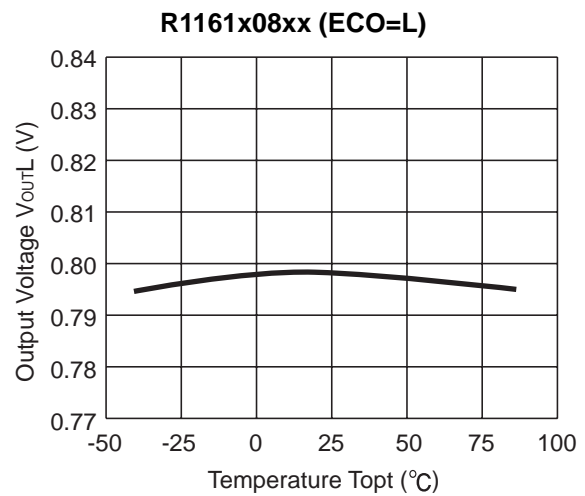
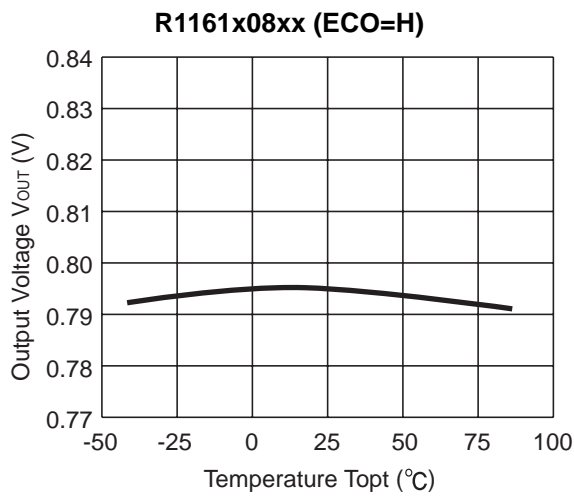

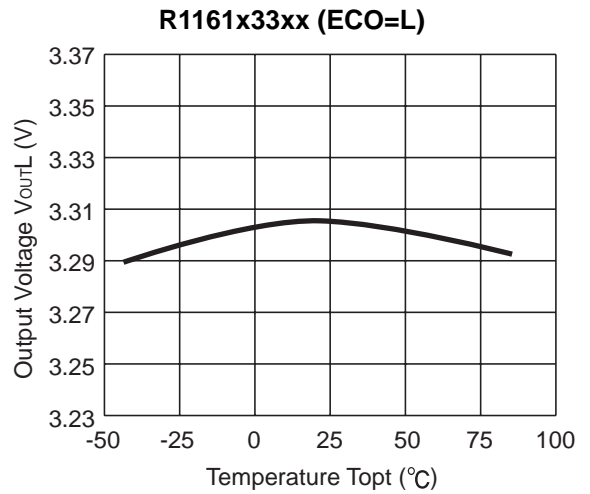
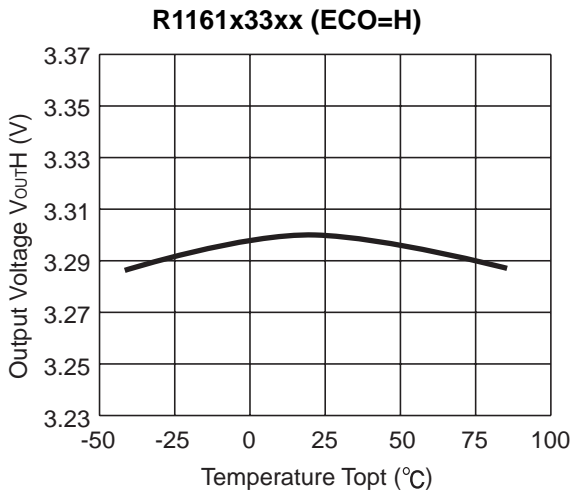

5) Supply Current vs. Temperature

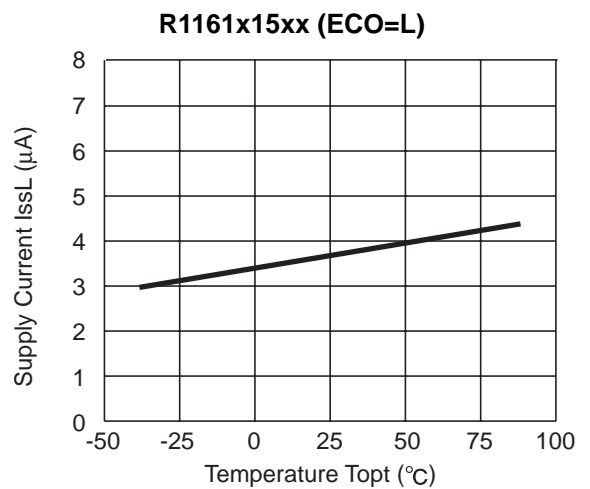
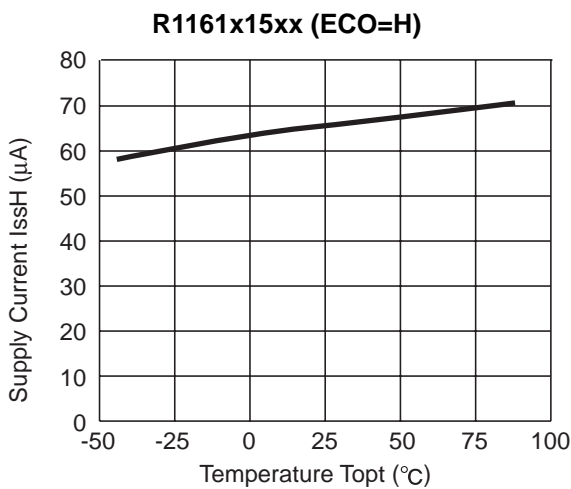
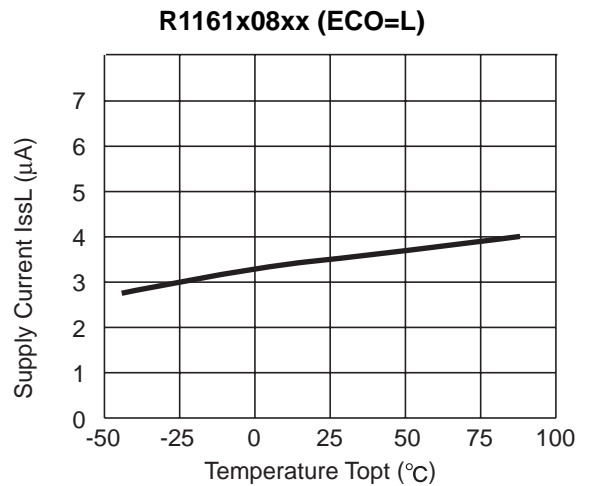
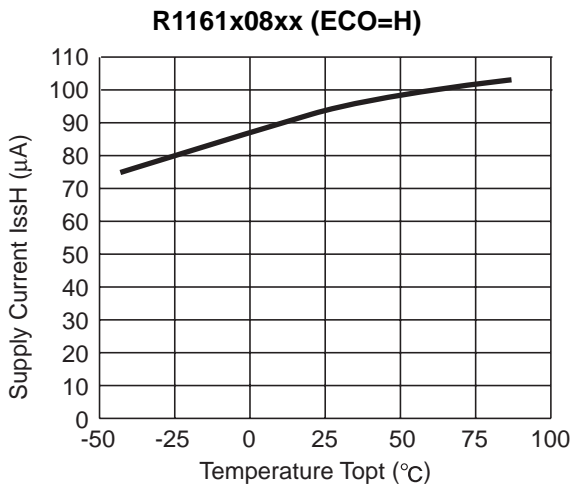

R1161x

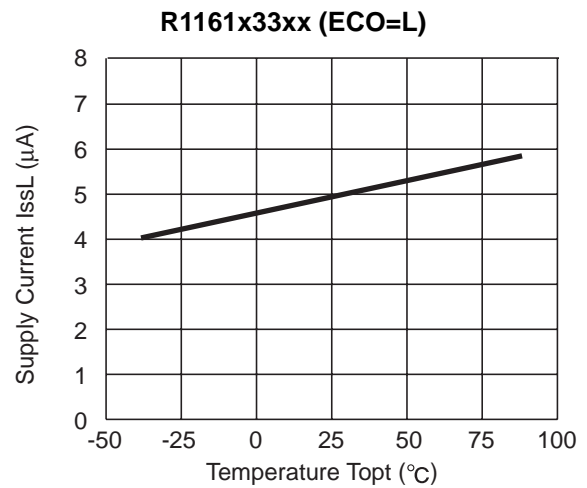
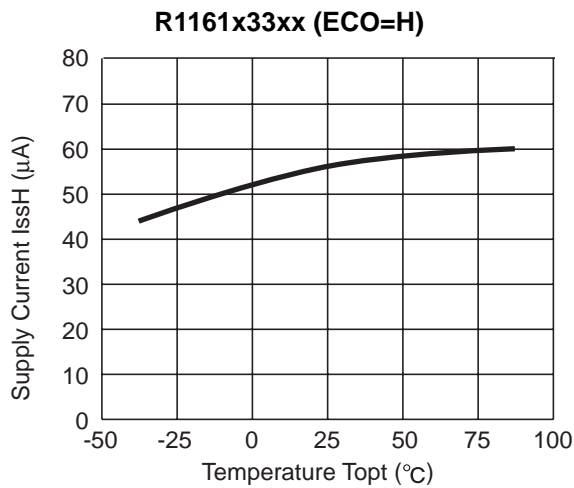
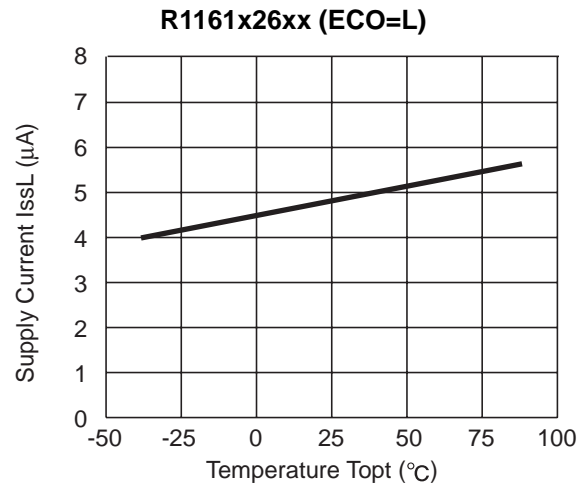
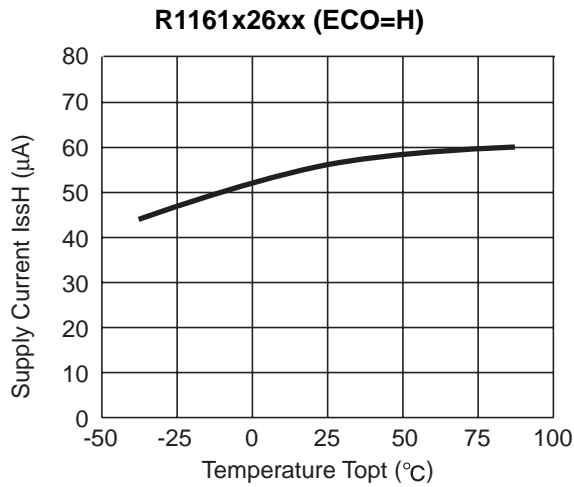

6) Dropout Voltage vs. Output Current

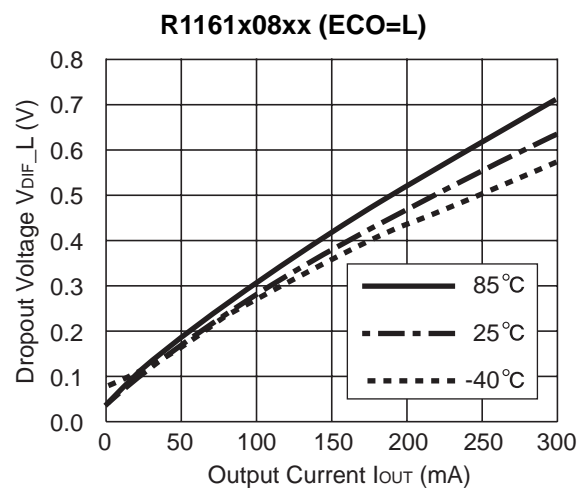
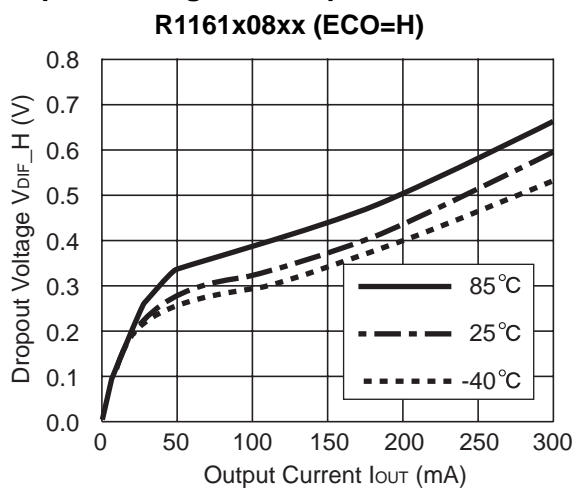

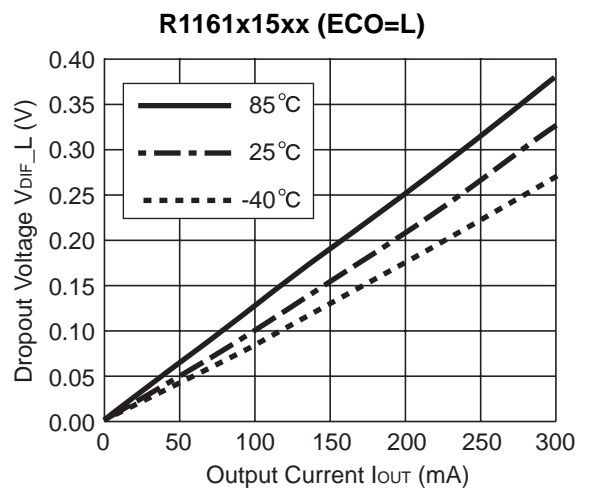
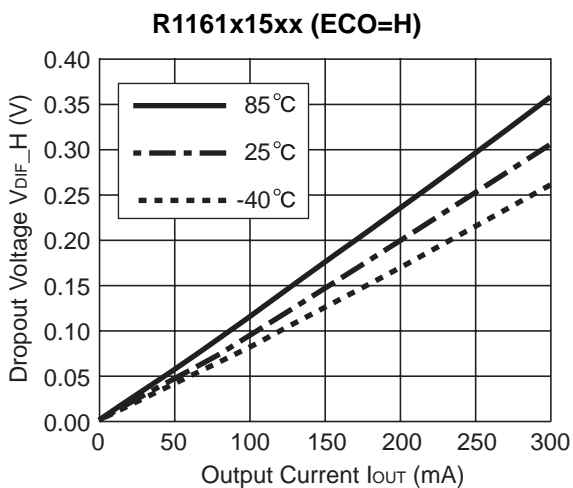
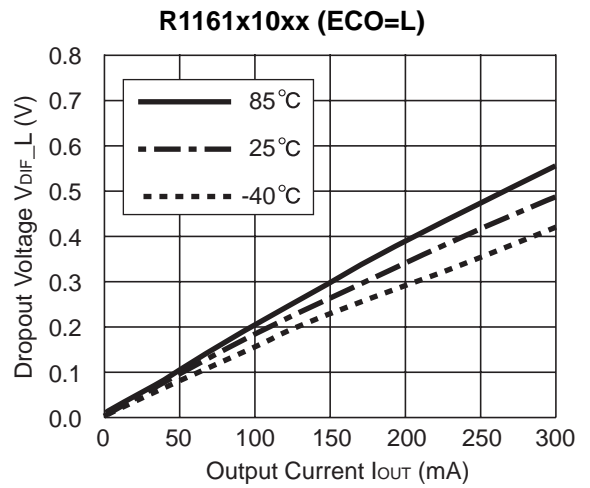
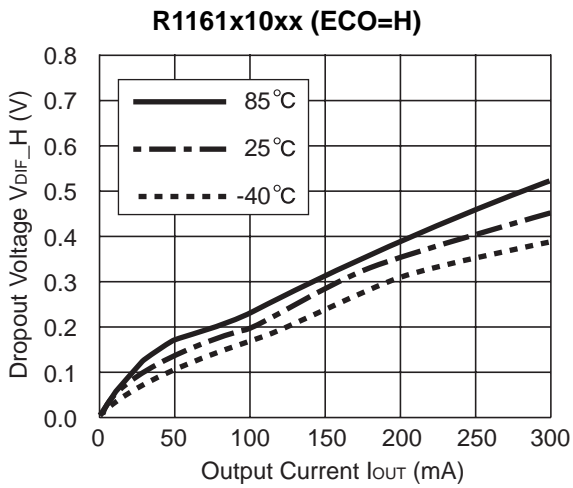
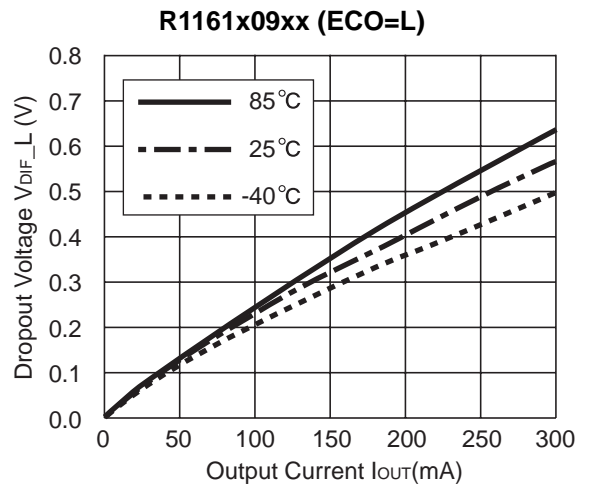
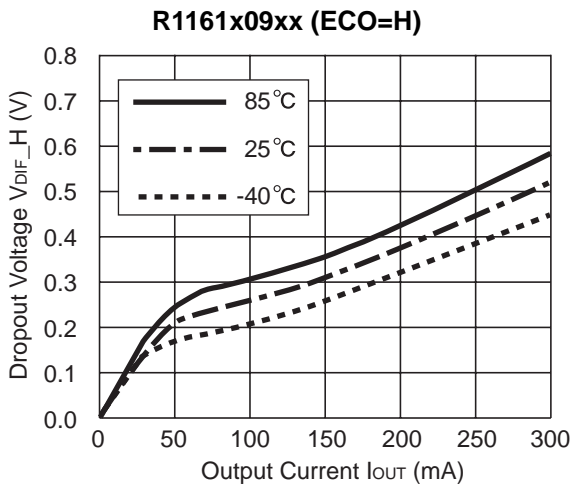

R1161x

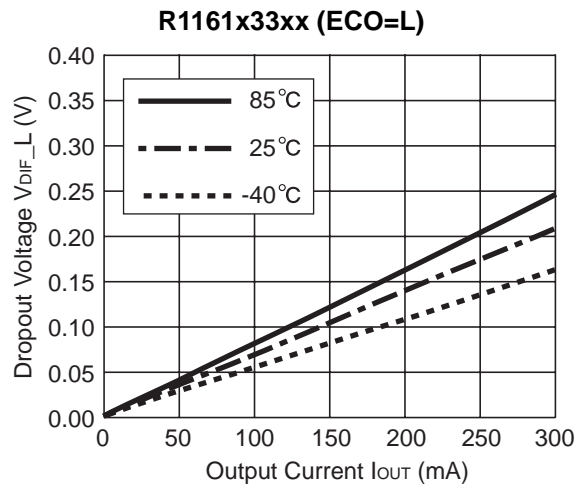
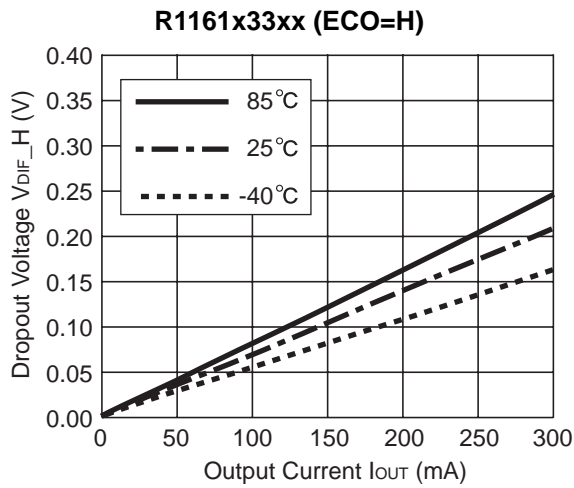
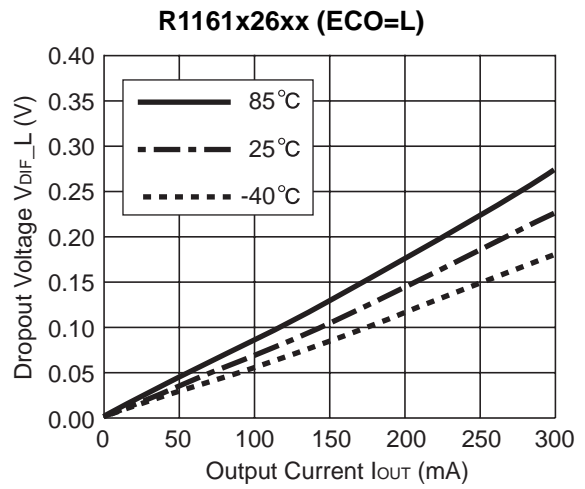
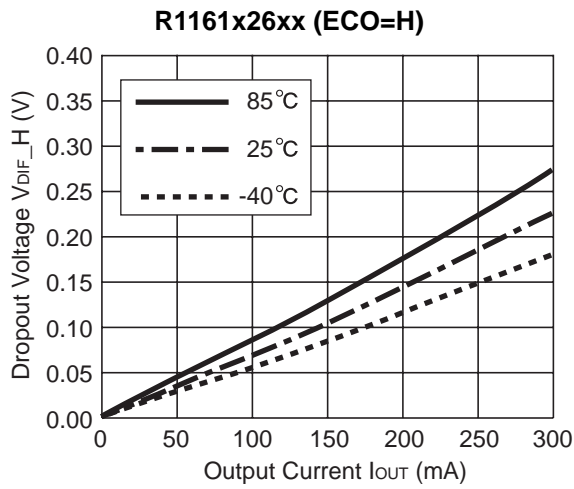

7) Dropout Voltage vs. Set Output Voltage (T_{opt}=25°C)

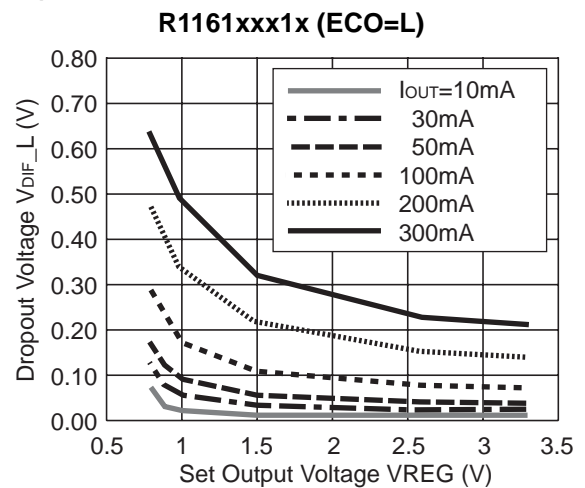
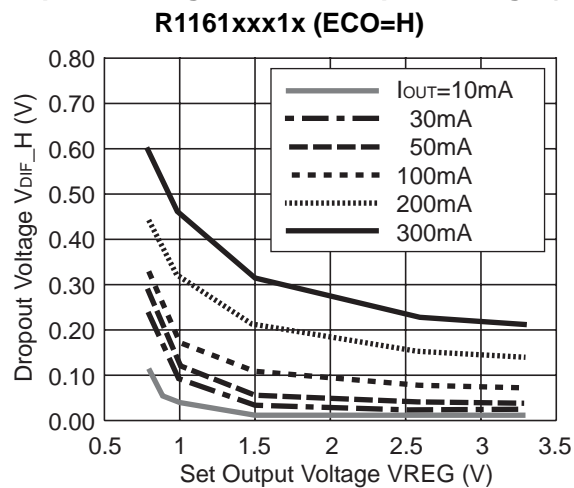

8) Ripple Rejection vs. Input Bias (Topt=25°C CIN=none, COUT=Ceramic 1.0μF Ripple 0.2Vp-P)

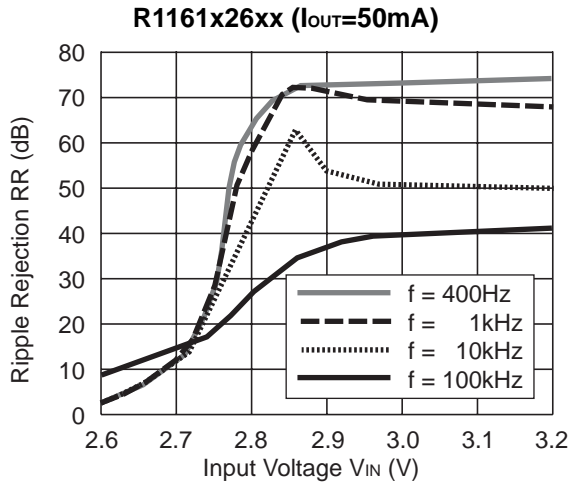
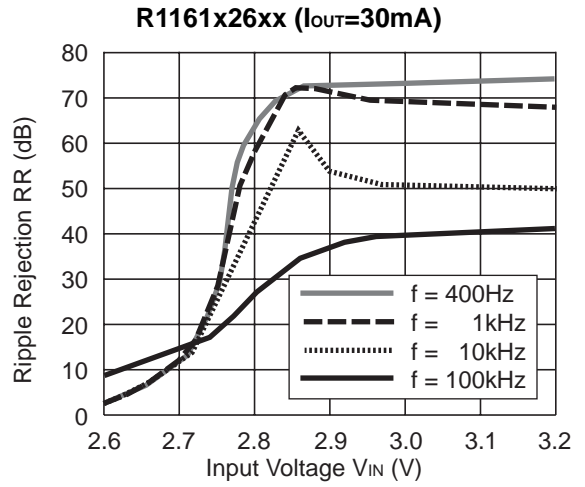
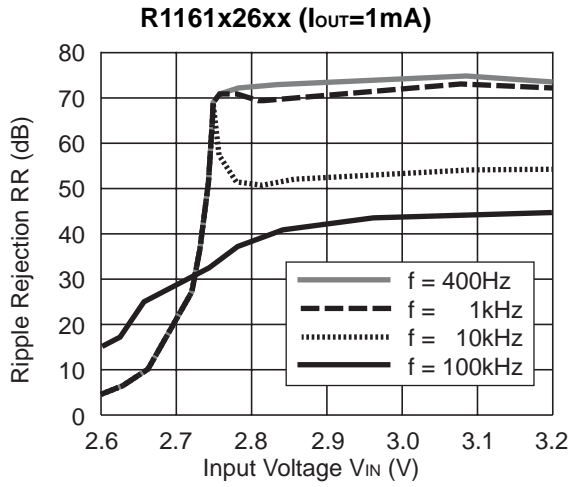

9) Ripple Rejection vs. Frequency (CIN=none)

R1161x08xx (ECO=H)

V_{IN}=1.8V_{DC}+0.2Vp-p,
C_{OUT}=Tantal 1.0μF

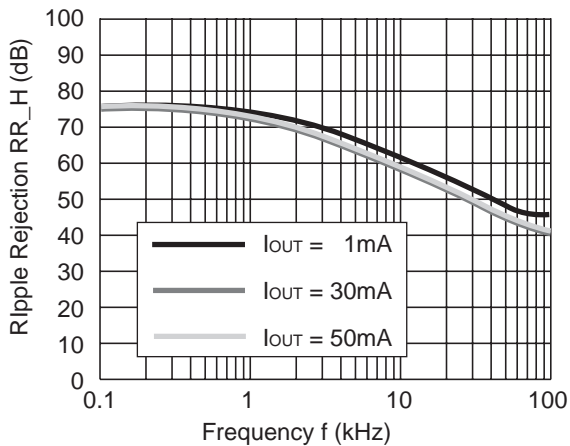

R1161x08xx (ECO=L)

V_{IN}=1.8V_{DC}+0.2Vp-p,
C_{OUT} = Tantal 1.0μF

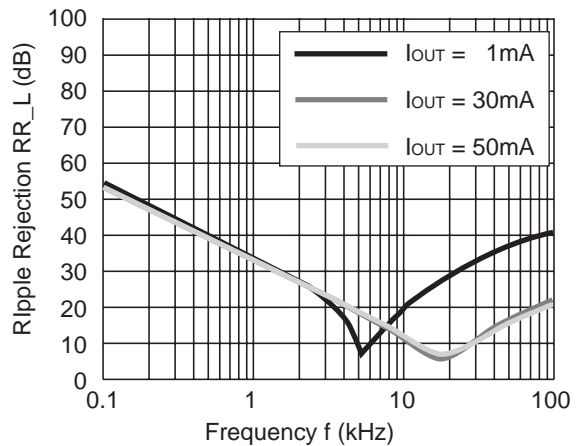

R1161x

R1161x08xx (ECO=H)

$V_{IN}=1.8V_{DC}+0.2V_{p-p}$,
 $C_{OUT}=\text{Tantal } 2.2\mu\text{F}$

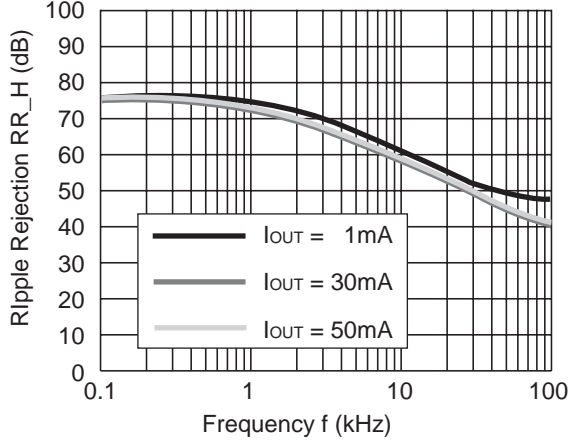

R1161x08xx (ECO=L)

$V_{IN}=1.8V_{DC}+0.2V_{p-p}$,
 $C_{OUT}=\text{Tantal } 2.2\mu\text{F}$

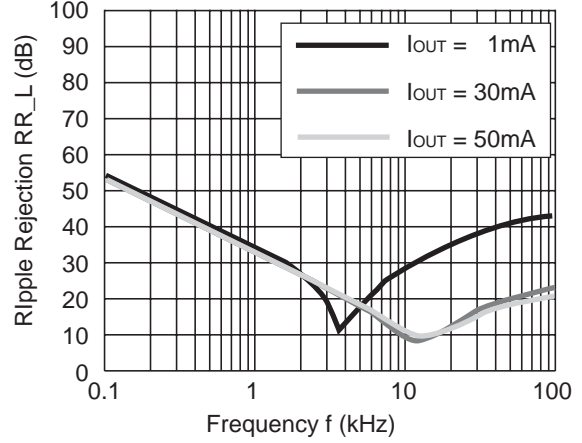

R1161x10xx (ECO=H)

$V_{IN}=2.0V_{DC}+0.2V_{p-p}$,
 $C_{OUT}=\text{Ceramic } 1.0\mu\text{F}$

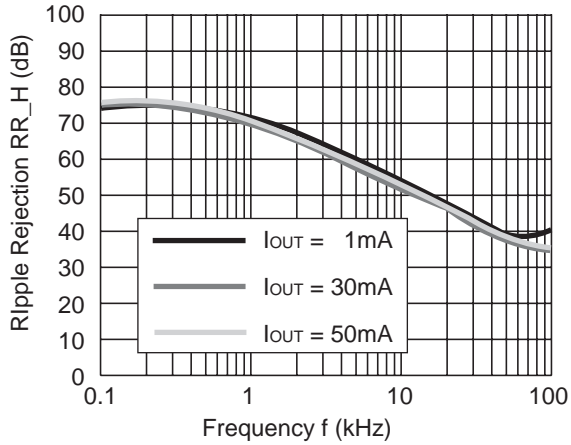

R1161x10xx (ECO=L)

$V_{IN}=2.0V_{DC}+0.2V_{p-p}$,
 $C_{OUT}=\text{Ceramic } 1.0\mu\text{F}$

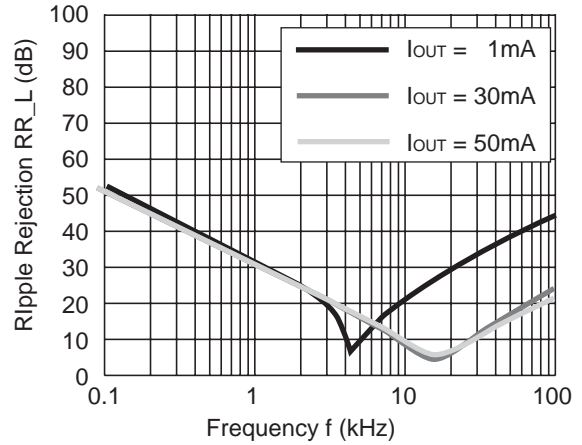

R1161x10xx (ECO=H)

$V_{IN}=2.0V_{DC}+0.2V_{p-p}$,
 $C_{OUT}=\text{Ceramic } 2.2\mu\text{F}$

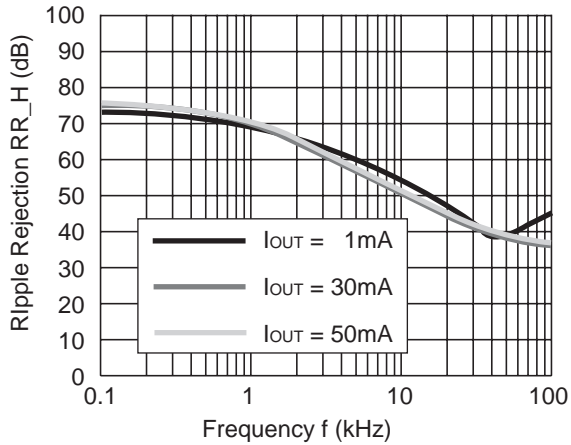

R1161x10xx (ECO=L)

$V_{IN}=2.0V_{DC}+0.2V_{p-p}$,
 $C_{OUT}=\text{Ceramic } 2.2\mu\text{F}$

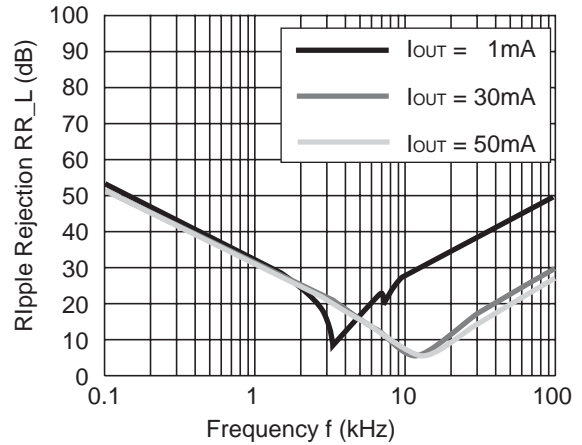

R1161x15xx (ECO=H)

$V_{IN}=2.5V_{DC}+0.2V_{p-p}$,
 $C_{OUT}=1.0\mu F$

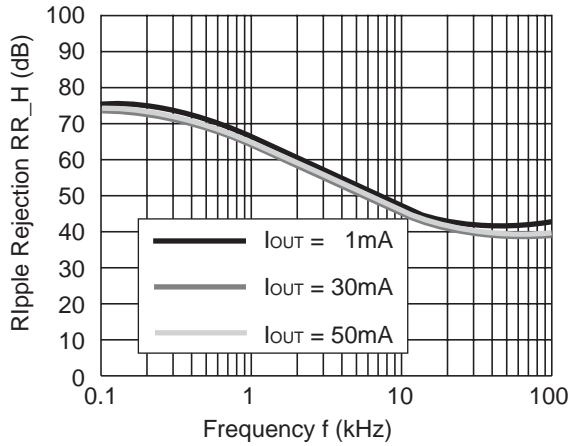

R1161x15xx (ECO=L)

$V_{IN}=2.5V_{DC}+0.2V_{p-p}$,
 $C_{OUT}=1.0\mu F$

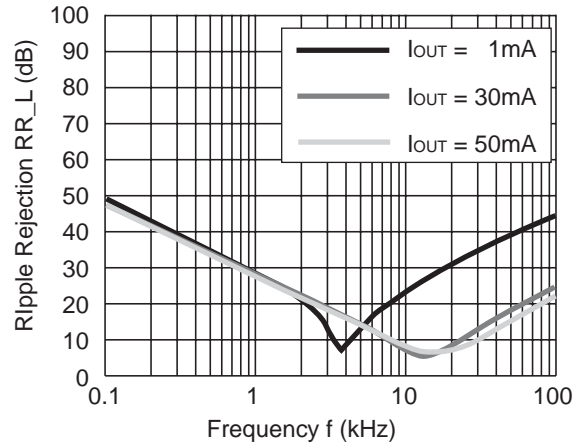

R1161x15xx (ECO=H)

$V_{IN}=2.5V_{DC}+0.2V_{p-p}$,
 $C_{OUT}=2.2\mu F$

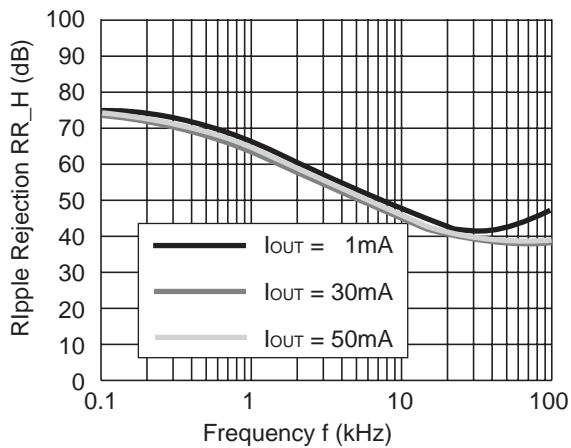

R1161x15xx (ECO=L)

$V_{IN}=2.5V_{DC}+0.2V_{p-p}$,
 $C_{OUT}=2.2\mu F$

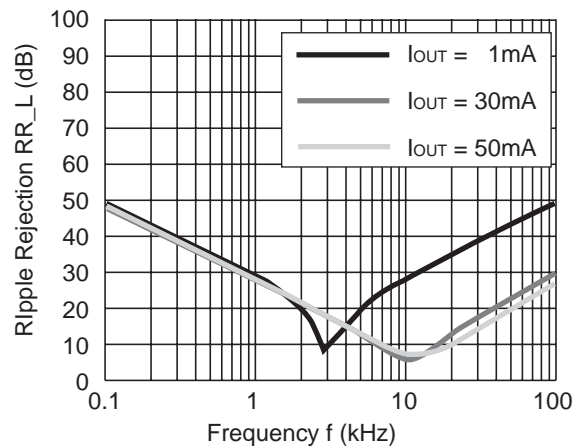

R1161x26xx (ECO=H)

$V_{IN}=3.6V_{DC}+0.2V_{p-p}$,
 $C_{OUT} = \text{Ceramic } 1.0\mu F$

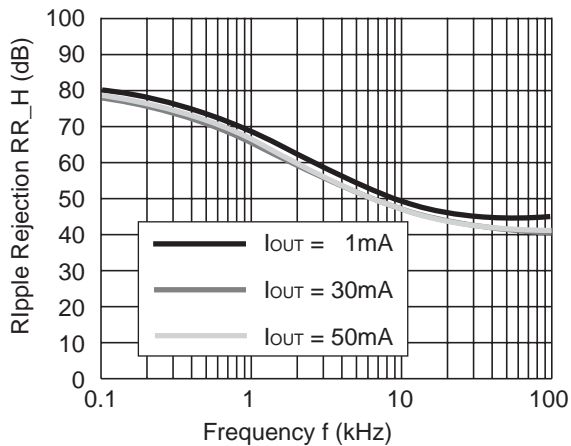

R1161x26xx (ECO=L)

$V_{IN}=3.6V_{DC}+0.2V_{p-p}$,
 $C_{OUT} = \text{Ceramic } 1.0\mu F$

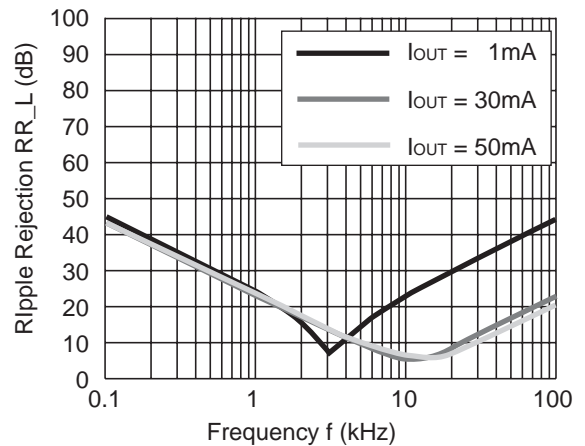

R1161x

R1161x26xx (ECO=H)

$V_{IN}=3.6V_{DC}+0.2V_{p-p}$,
 $C_{OUT} = \text{Ceramic } 2.2\mu F$

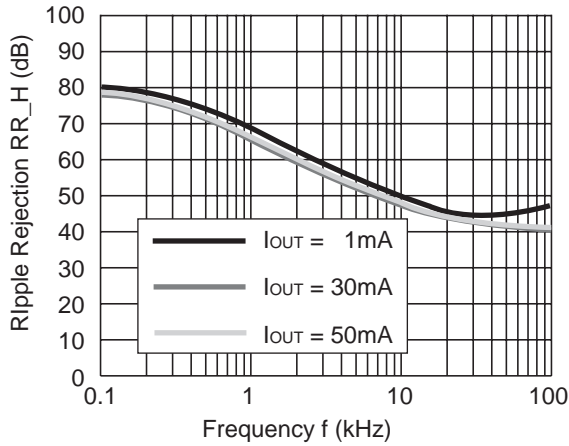

R1161x26xx (ECO=L)

$V_{IN}=3.6V_{DC}+0.2V_{p-p}$,
 $C_{OUT} = \text{Ceramic } 2.2\mu F$

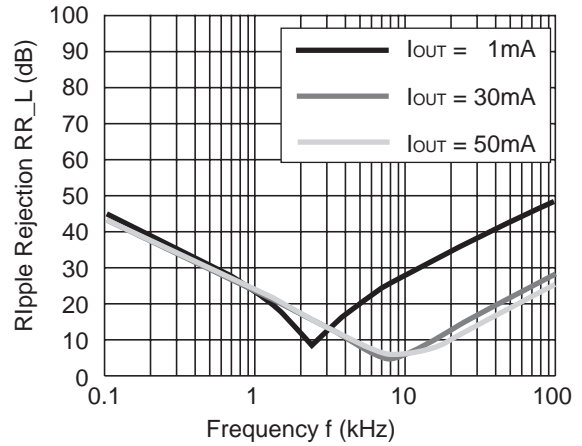

R1161x33xx (ECO=H)

$V_{IN}=4.3V_{DC}+0.2V_{p-p}$,
 $C_{OUT} = \text{Ceramic } 1.0\mu F$

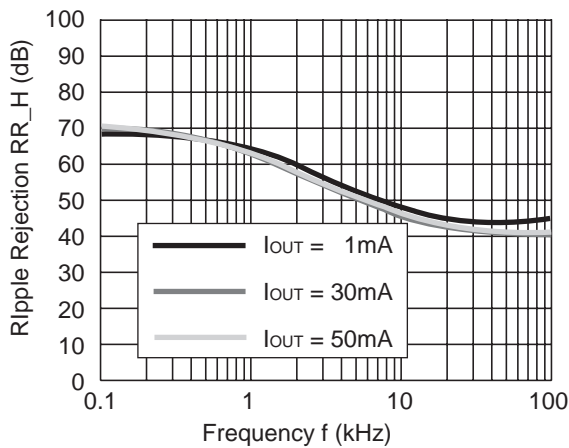

R1161x33xx (ECO=L)

$V_{IN}=4.3V_{DC}+0.2V_{p-p}$,
 $C_{OUT} = \text{Ceramic } 1.0\mu F$

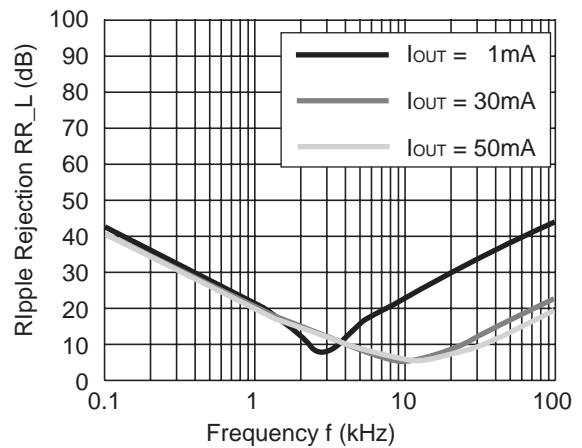

R1161x33xx (ECO=H)

$V_{IN}=4.3V_{DC}+0.2V_{p-p}$,
 $C_{OUT} = \text{Ceramic } 2.2\mu F$

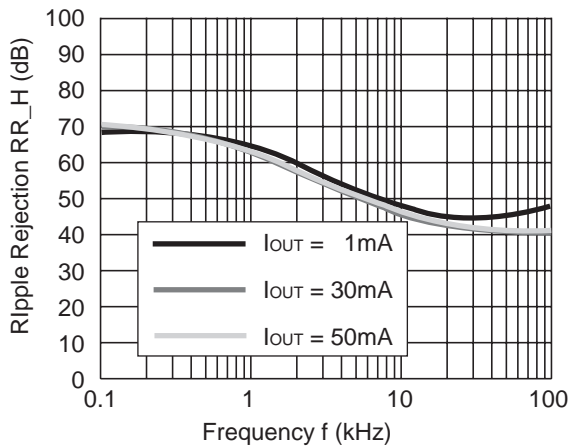

R1161x33xx (ECO=L)

$V_{IN}=4.3V_{DC}+0.2V_{p-p}$,
 $C_{OUT} = \text{Ceramic } 2.2\mu F$

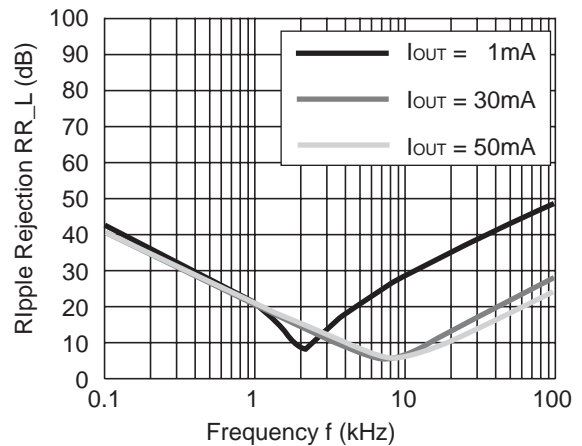

10) Input Transient Response ($C_{IN} = \text{none}$, $t_r = t_f = 5\mu\text{s}$)

R1161x08xx (ECO=H)

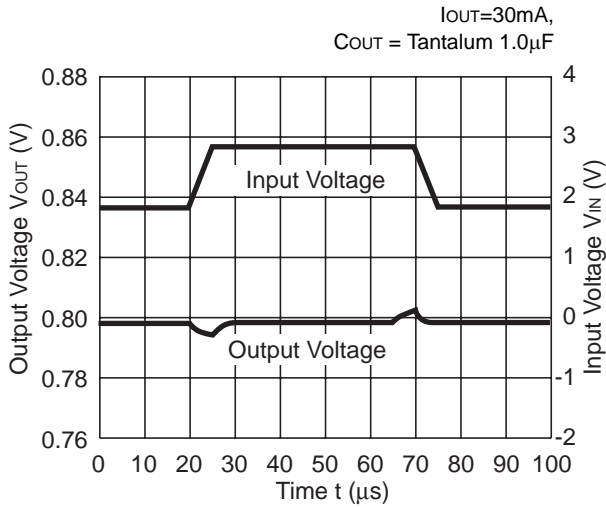

R1161x08xx (ECO=L)

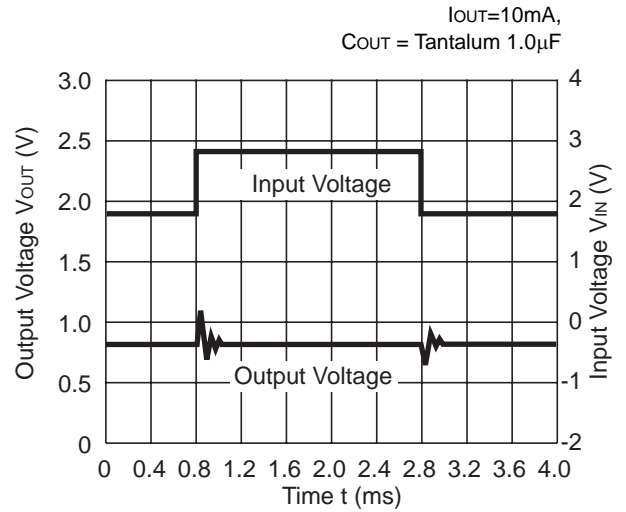

R1161x10xx (ECO=H)

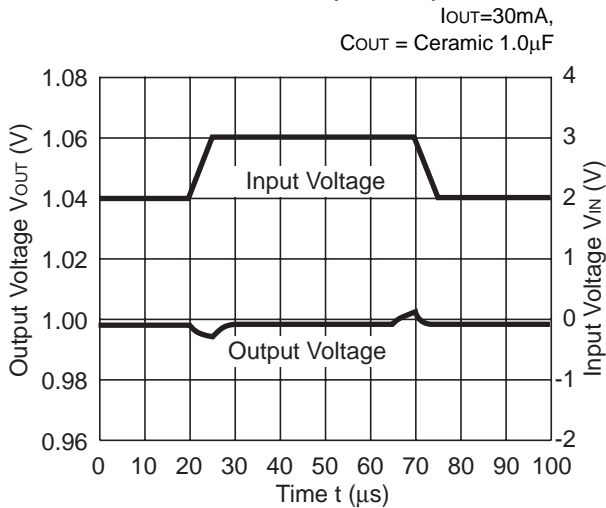

R1161x10xx (ECO=L)

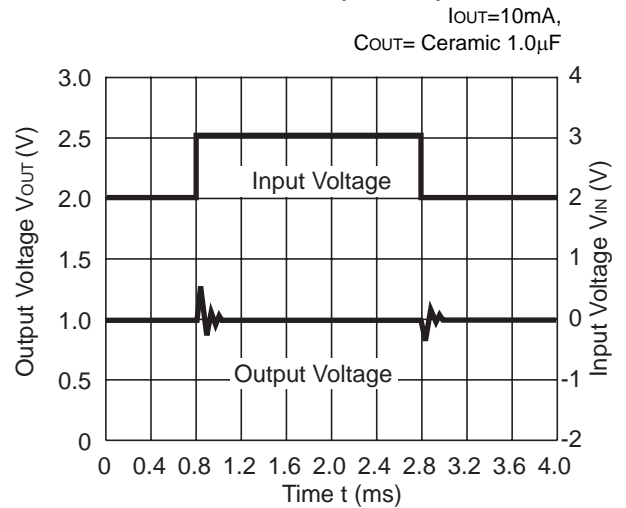

R1161x26xx (ECO=H)

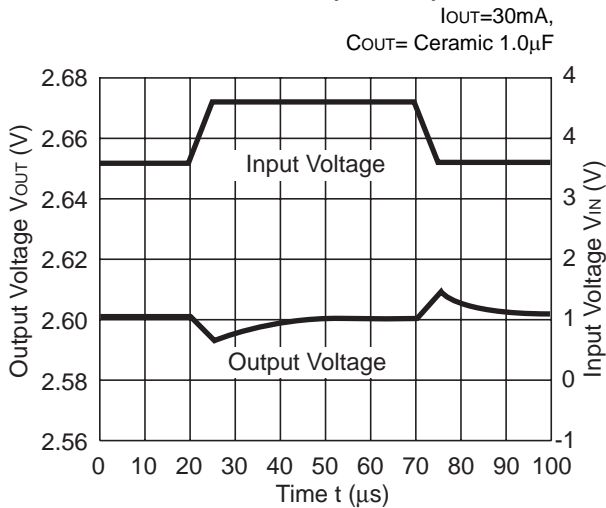

R1161x26xx (ECO=L)

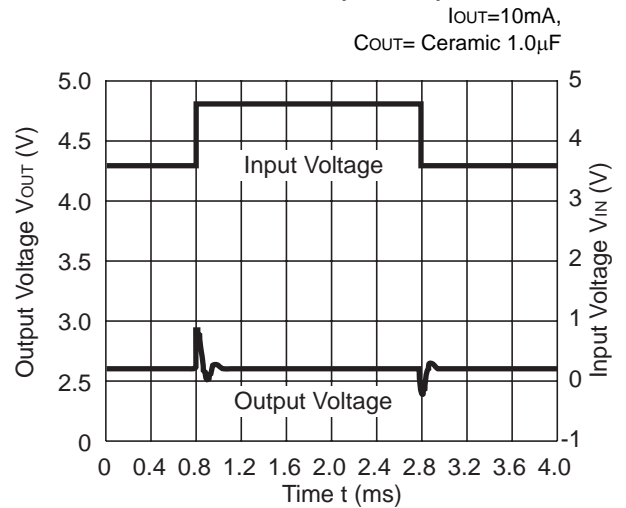

R1161x

11) Load Transient Response ($t_r=t_f=0.5\mu s$)

R1161x08xx (ECO=H)

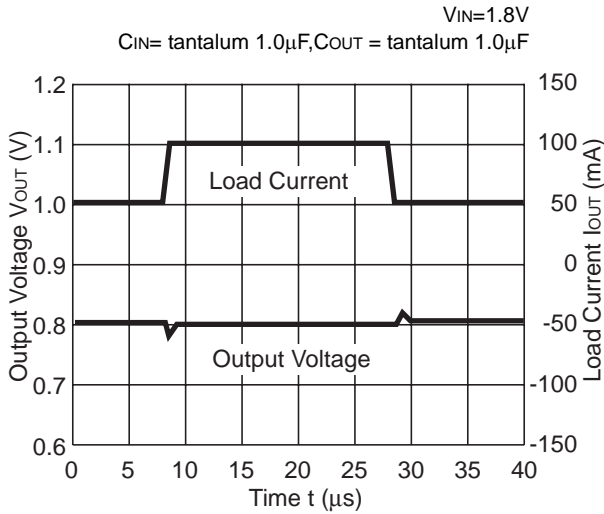

R1161x08xx (ECO=H)

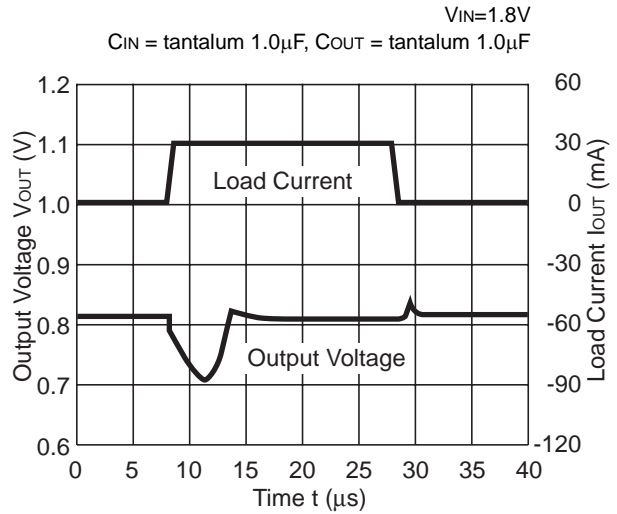

R1161x08xx (ECO=H)

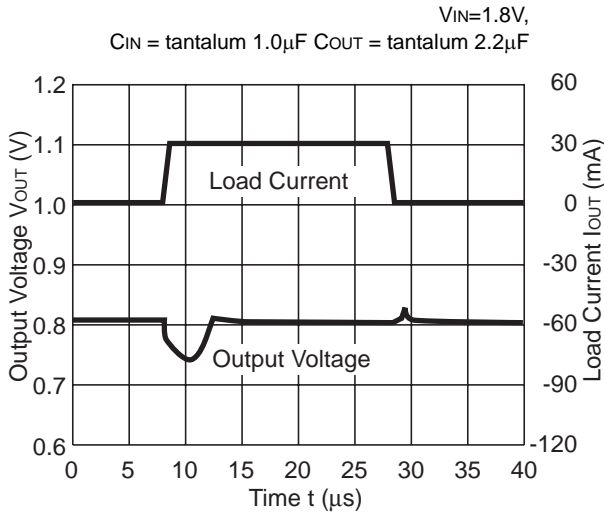

R1161x08xx (ECO=L)

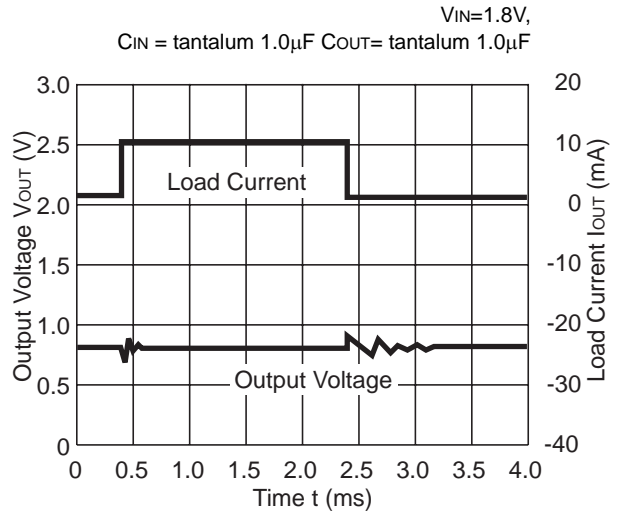

R1161x08xx (ECO=L)

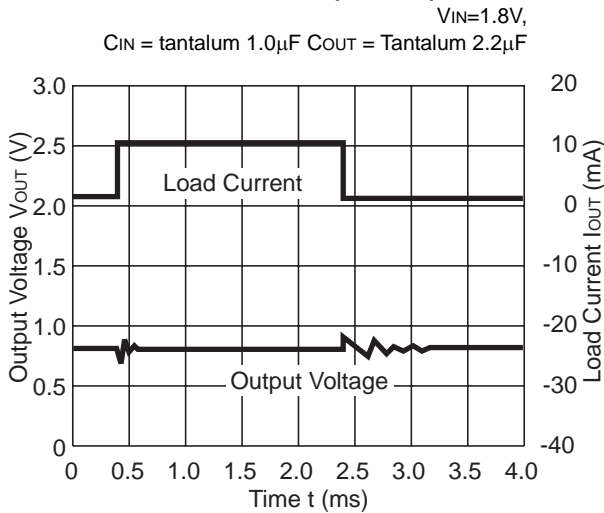

R1161x10xx (ECO=H)

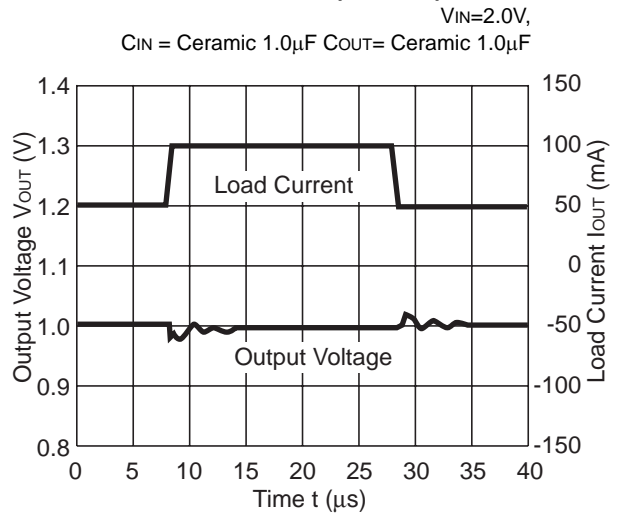

R1161x10xx (ECO=H)

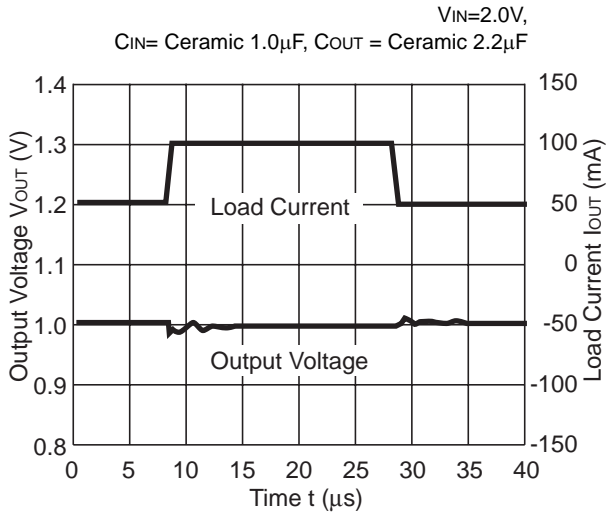

R1161x10xx (ECO=H)

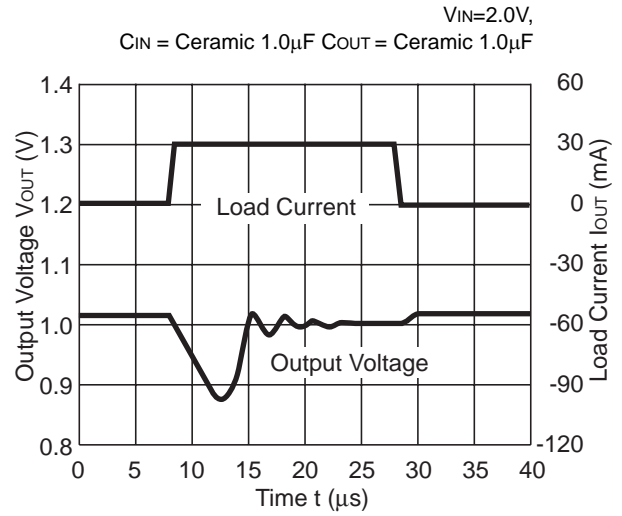

R1161x10xx (ECO=H)

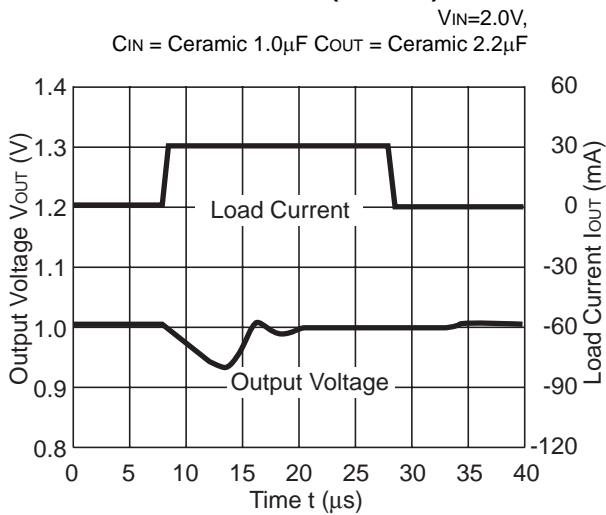

R1161x10xx (ECO=H)

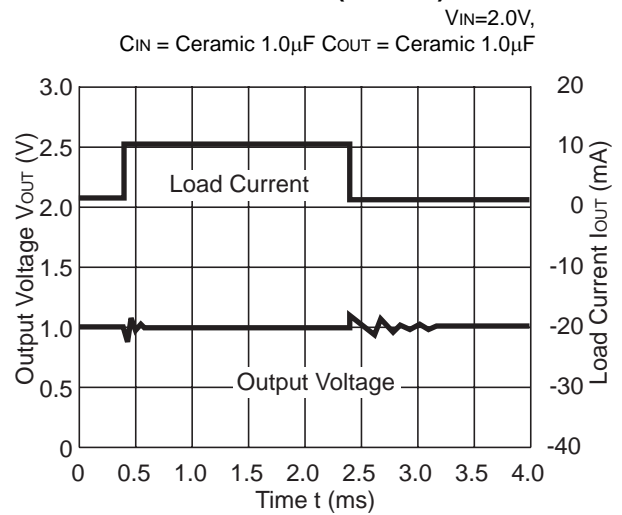

R1161x10xx (ECO=L)

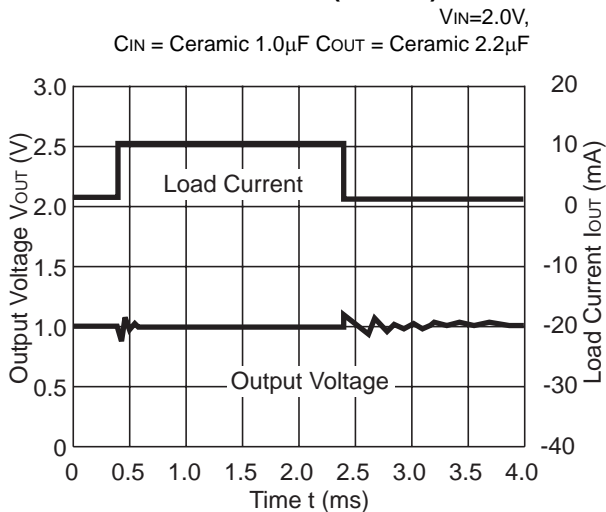

R1161x10xx (ECO=L)

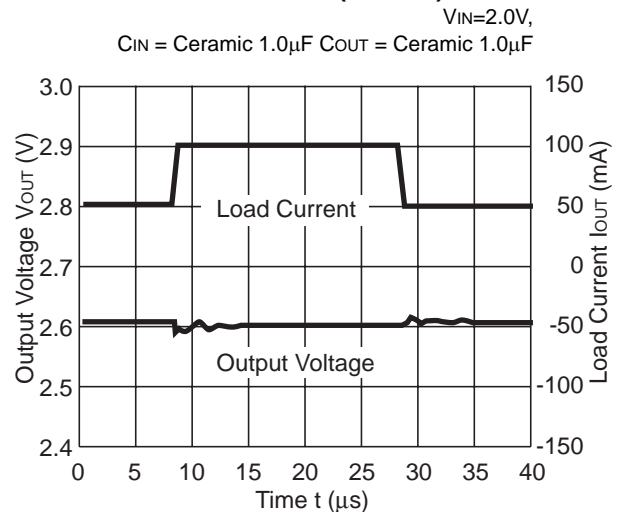

R1161x

R1161x26xx (ECO=H)

$V_{IN}=3.6V$,
 C_{IN} = Ceramic $1.0\mu F$ C_{OUT} = Ceramic $2.2\mu F$

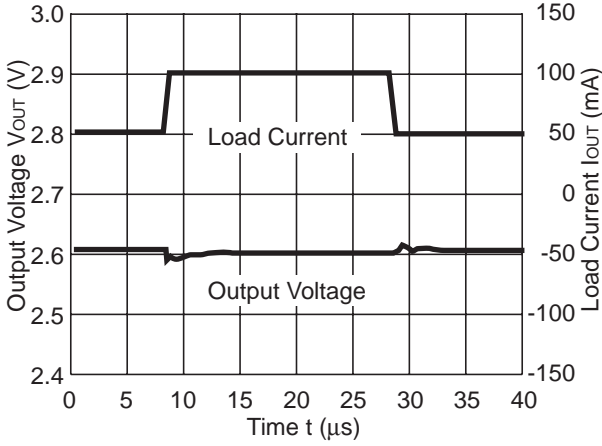

R1161x26xx (ECO=H)

$V_{IN}=3.6V$,
 C_{IN} = Ceramic $1.0\mu F$ C_{OUT} = Ceramic $1.0\mu F$

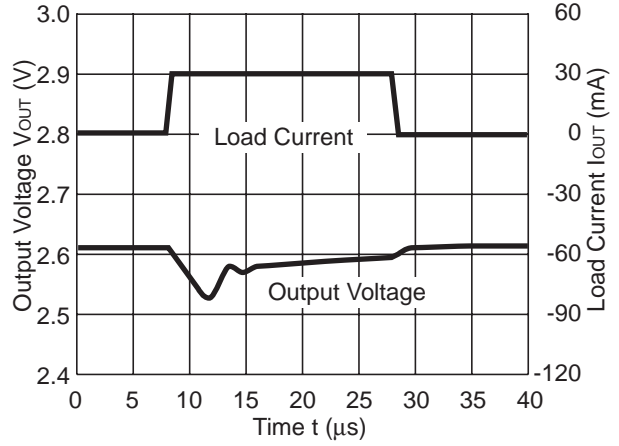

R1161x26xx (ECO=H)

$V_{IN}=3.6V$,
 C_{IN} = Ceramic $1.0\mu F$ C_{OUT} = Ceramic $2.2\mu F$

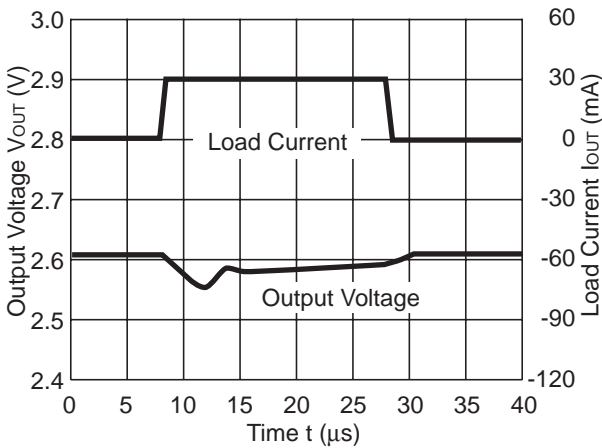

R1161x26xx (ECO=L)

$V_{IN}=3.6V$,
 C_{IN} = Ceramic $1.0\mu F$ C_{OUT} = Ceramic $1.0\mu F$

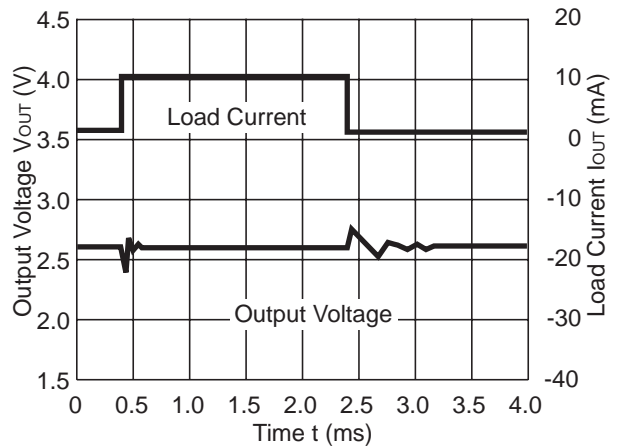

R1161x26xx (ECO=L)

$V_{IN}=3.6V$,
 C_{IN} = Ceramic $1.0\mu F$ C_{OUT} = Ceramic $2.2\mu F$

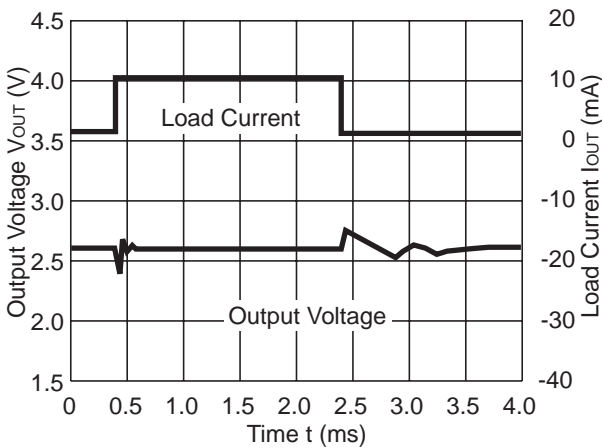

12) Turn on speed with CE pin

R1161x08xx (ECO=H)

$V_{IN}=1.8V$, C_{IN} = Tantalum $1.0\mu F$
 C_{OUT} = Tantalum $1.0\mu F$

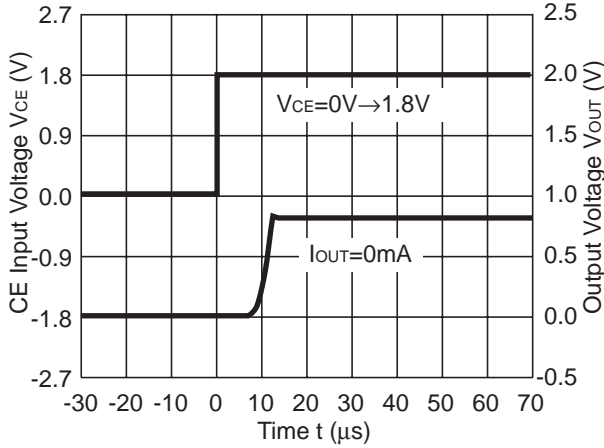

R1161x08xx (ECO=L)

$V_{IN}=1.8V$, C_{IN} = Tantalum $1.0\mu F$
 C_{OUT} = Tantalum $1.0\mu F$

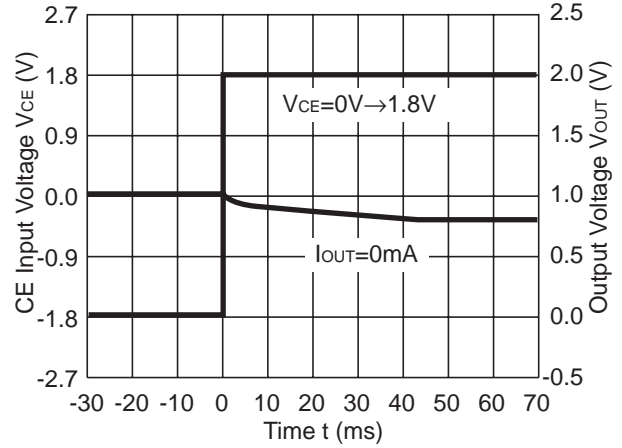

R1161x08xx (ECO=H)

$V_{IN}=1.8V$, C_{IN} = Tantalum $1.0\mu F$
 C_{OUT} = Tantalum $1.0\mu F$

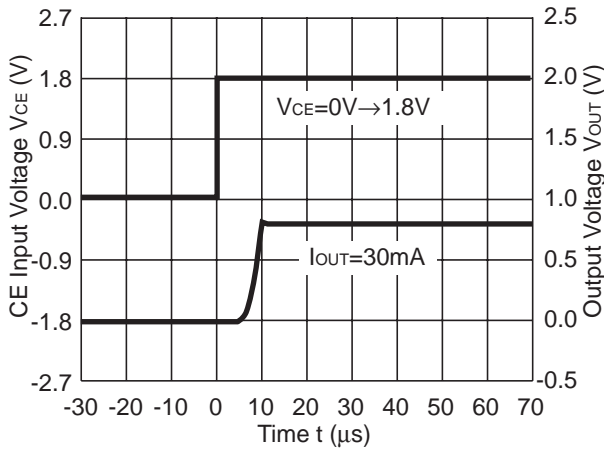

R1161x08xx (ECO=L)

$V_{IN}=1.8V$, C_{IN} = Tantalum $1.0\mu F$
 C_{OUT} = Tantalum $1.0\mu F$

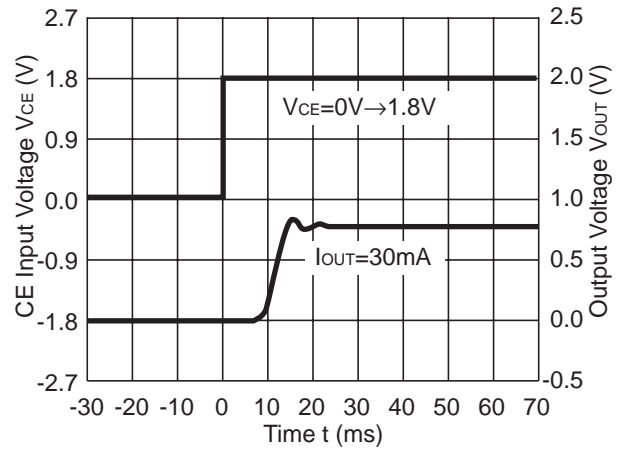

R1161x08xx (ECO=H)

$V_{IN}=1.8V$, C_{IN} = Tantalum $1.0\mu F$
 C_{OUT} = Tantalum $1.0\mu F$

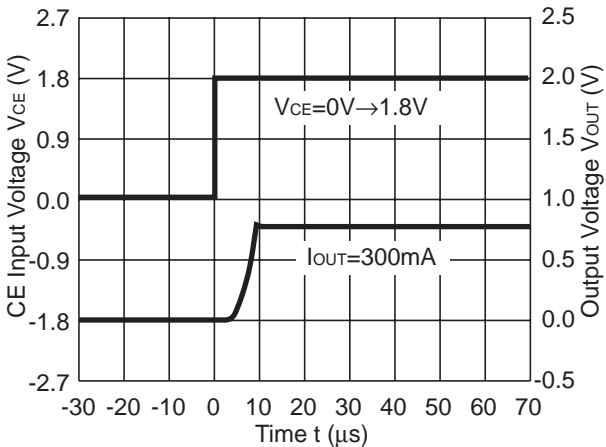

R1161x08xx (ECO=L)

$V_{IN}=1.8V$, C_{IN} = Tantalum $1.0\mu F$
 C_{OUT} = Tantalum $1.0\mu F$

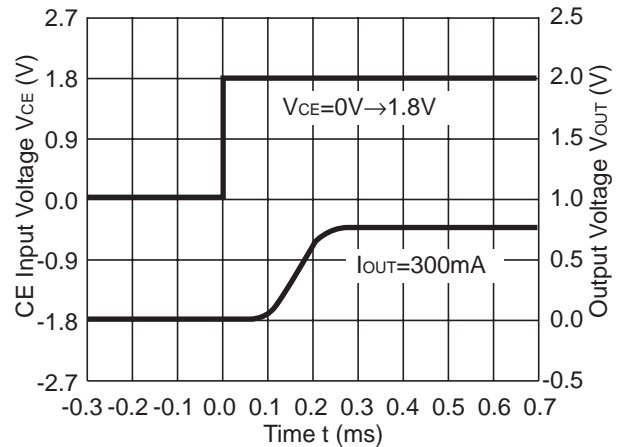

R1161x

R1161x33xx (ECO=H)

$V_{IN}=4.3V$, C_{IN} = Ceramic $1.0\mu F$
 C_{OUT} = Ceramic $1.0\mu F$

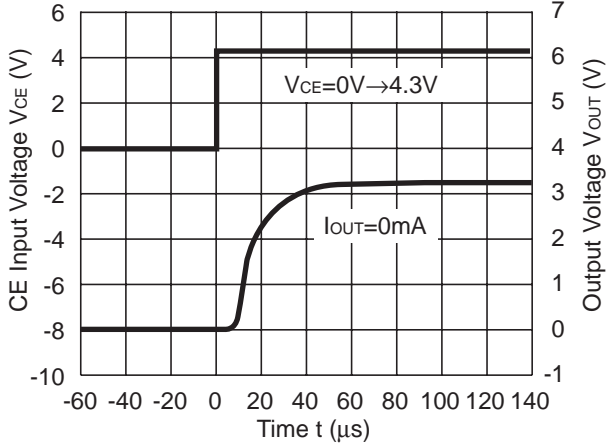

R1161x33xx (ECO=L)

$V_{IN}=4.3V$, C_{IN} = Ceramic $1.0\mu F$
 C_{OUT} = Ceramic $1.0\mu F$

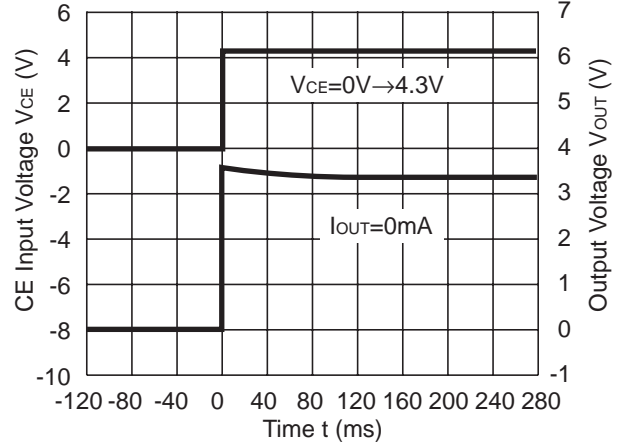

R1161x33xx (ECO=H)

$V_{IN}=4.3V$, C_{IN} = Ceramic $1.0\mu F$
 C_{OUT} = Ceramic $1.0\mu F$

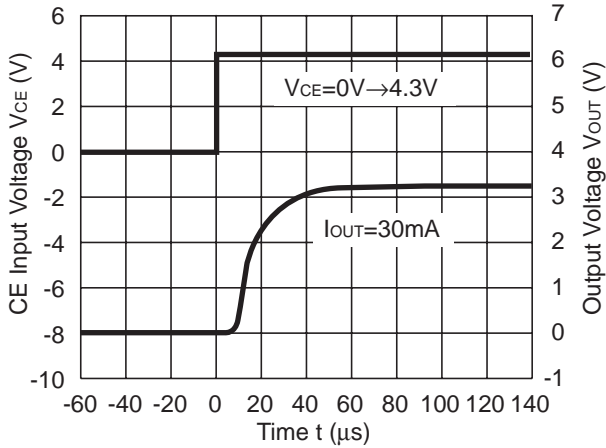

R1161x33xx (ECO=L)

$V_{IN}=4.3V$, C_{IN} = Ceramic $1.0\mu F$
 C_{OUT} = Ceramic $1.0\mu F$

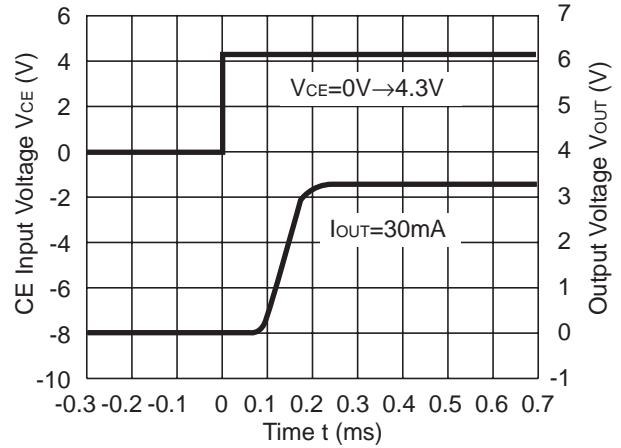

R1161x33xx (ECO=H)

$V_{IN}=4.3V$, C_{IN} = Ceramic $1.0\mu F$
 C_{OUT} = Ceramic $1.0\mu F$

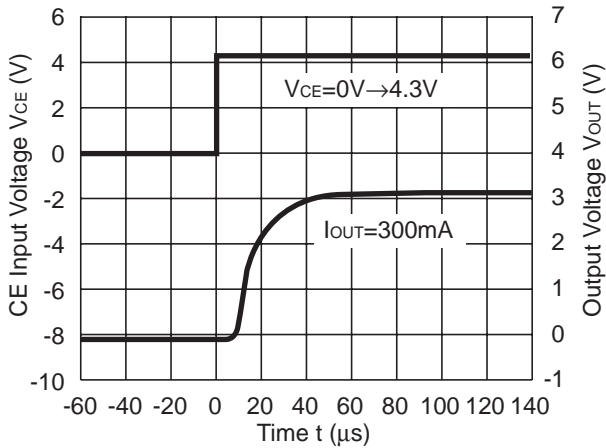

R1161x33xx (ECO=L)

$V_{IN}=4.3V$, C_{IN} = Ceramic $1.0\mu F$
 C_{OUT} = Ceramic $1.0\mu F$

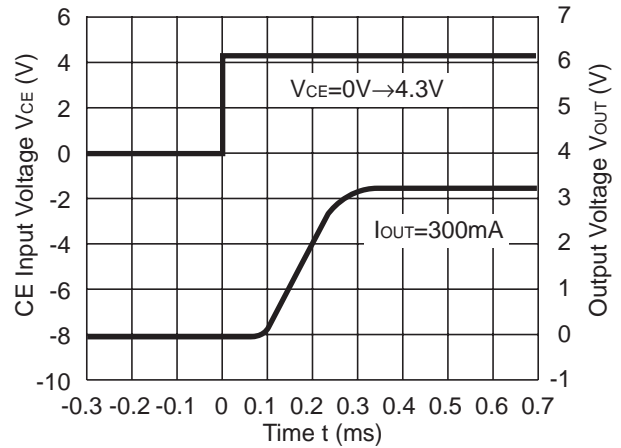

13) Turn-off Speed with CE

R1161x08xD

$V_{IN}=1.8V$, C_{IN} = Tantalum $1.0\mu F$
 C_{OUT} = Tantalum $1.0\mu F$

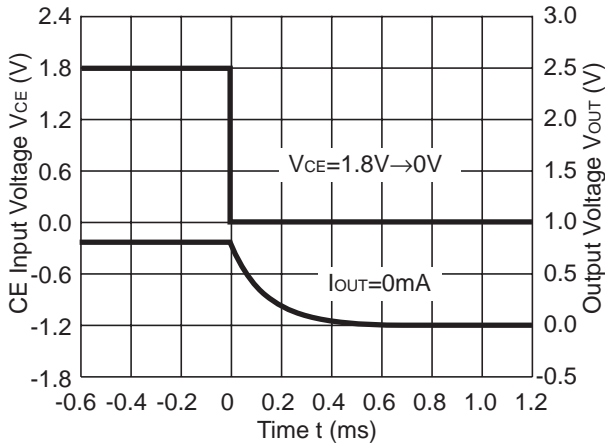

R1161x08xD

$V_{IN}=1.8V$, C_{IN} = Tantalum $1.0\mu F$
 C_{OUT} = Tantalum $1.0\mu F$

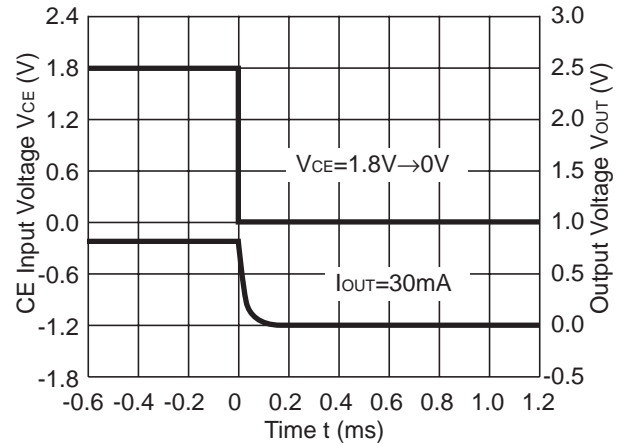

R1161x08xD

$V_{IN}=1.8V$, C_{IN} = Tantalum $1.0\mu F$
 C_{OUT} = Tantalum $1.0\mu F$

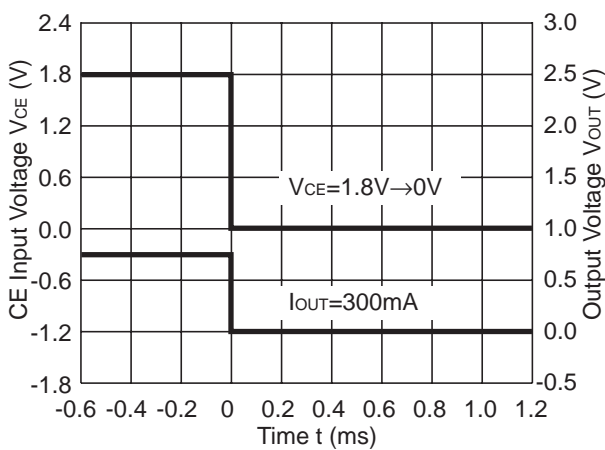

R1161x33xD

$V_{IN}=4.3V$, C_{IN} = Ceramic $1.0\mu F$
 C_{OUT} = Ceramic $1.0\mu F$

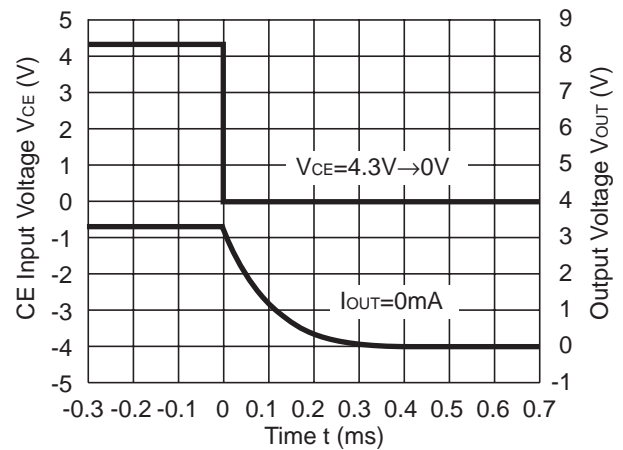

R1161x33xD

$V_{IN}=4.3V$, C_{IN} = Ceramic $1.0\mu F$
 C_{OUT} = Ceramic $1.0\mu F$

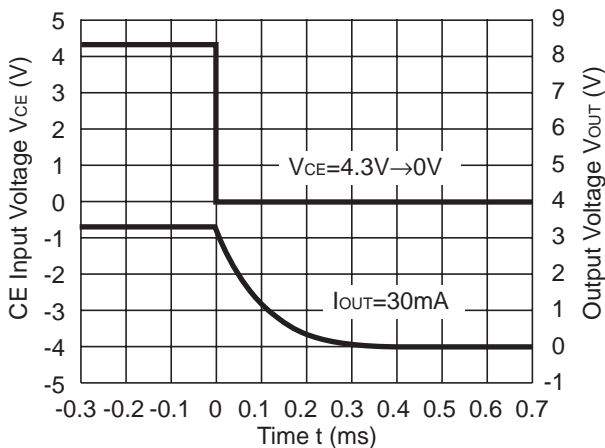

R1161x33xD

$V_{IN}=4.3V$, C_{IN} = Ceramic $1.0\mu F$
 C_{OUT} = Ceramic $1.0\mu F$

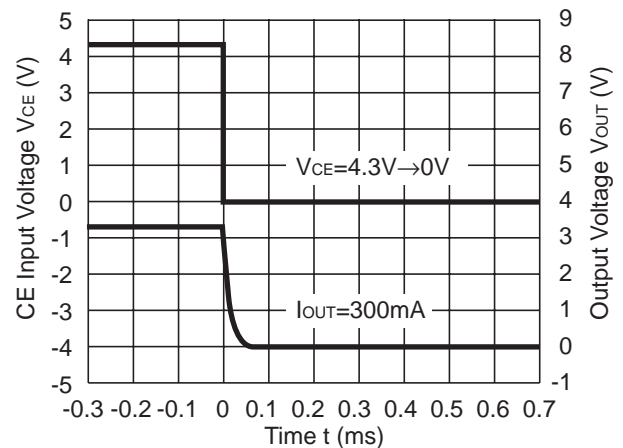

R1161x

14) Output Voltage at Mode alternative point

R1161x08xx

$V_{IN}=1.8V$, C_{IN} = Ceramic $1.0\mu F$
 C_{OUT} = Tantalum $1.0\mu F$

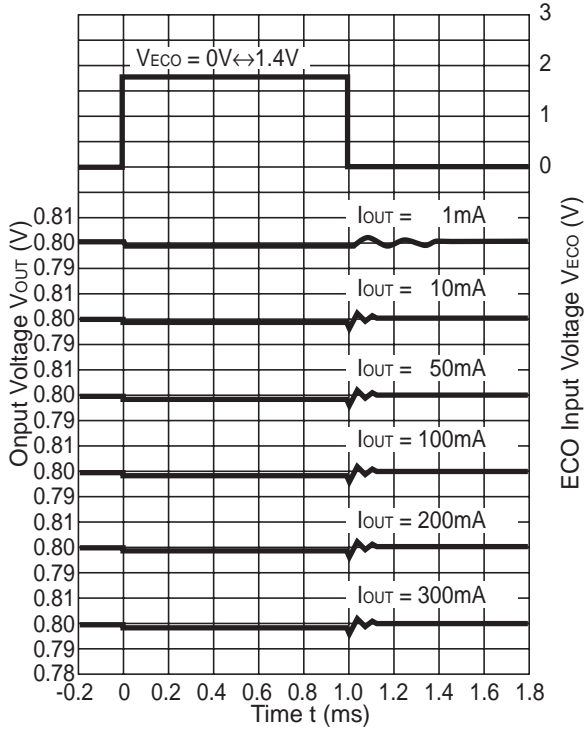

R1161x08xx

$V_{IN}=1.8V$, C_{IN} = Ceramic $1.0\mu F$
 C_{OUT} = Tantalum $1.0\mu F$

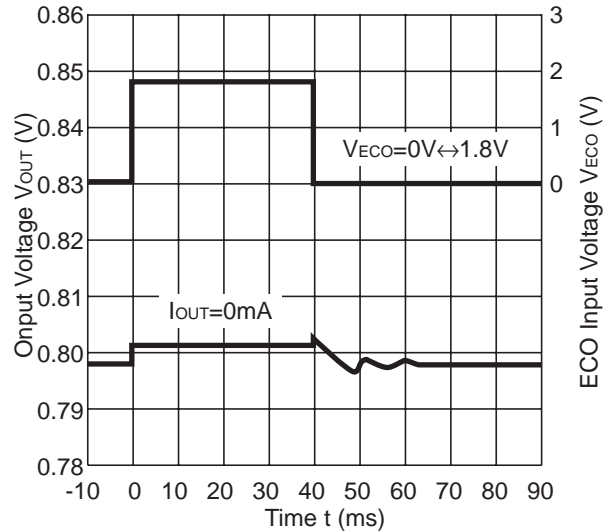

R1161x10xx

$V_{IN}=2.0V$, C_{IN} = Ceramic $1.0\mu F$
 C_{OUT} = Ceramic $1.0\mu F$

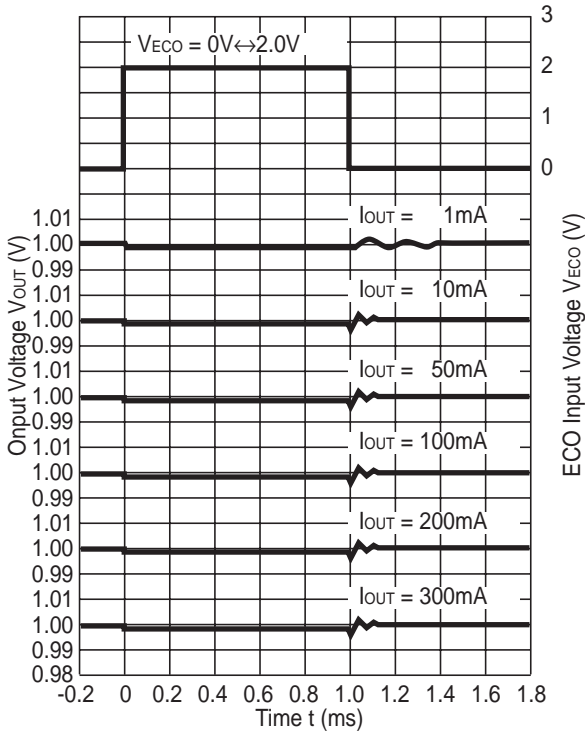

R1161x10xx

$V_{IN}=2.0V$, C_{IN} = Ceramic $1.0\mu F$
 C_{OUT} = Ceramic $1.0\mu F$

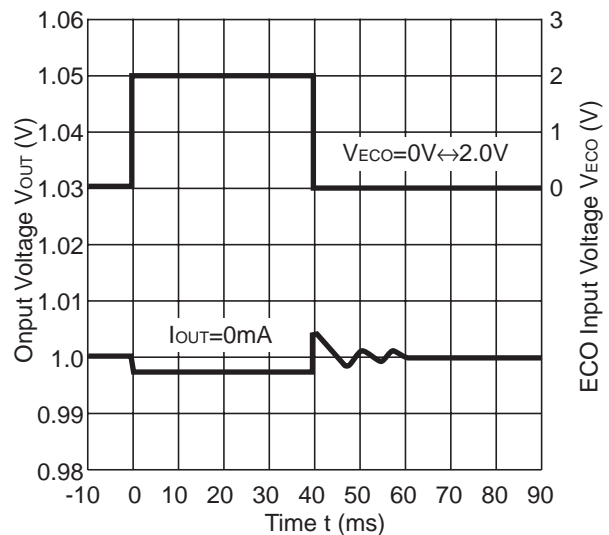

R1161x26xx

$V_{IN}=3.6V$, C_{IN} = Ceramic $1.0\mu F$
 C_{OUT} = Ceramic $1.0\mu F$

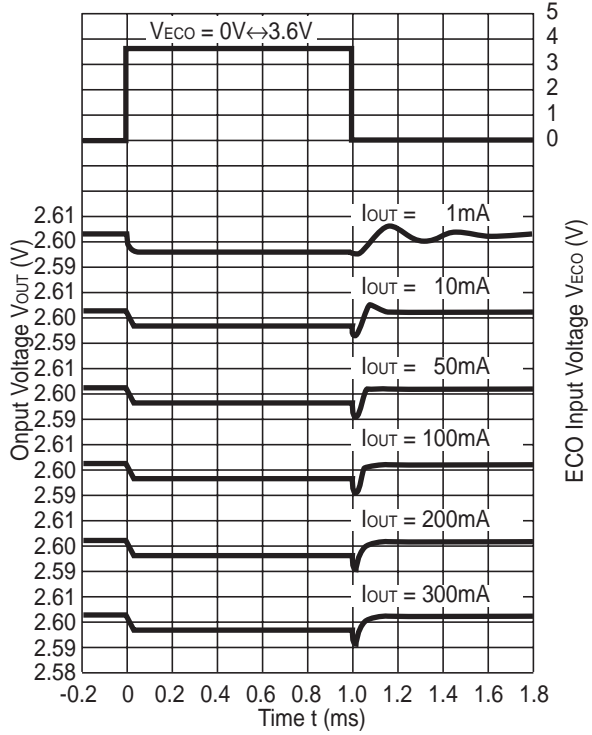

R1161x26xx

$V_{IN}=3.6V$, C_{IN} = Ceramic $1.0\mu F$
 C_{OUT} = Ceramic $1.0\mu F$

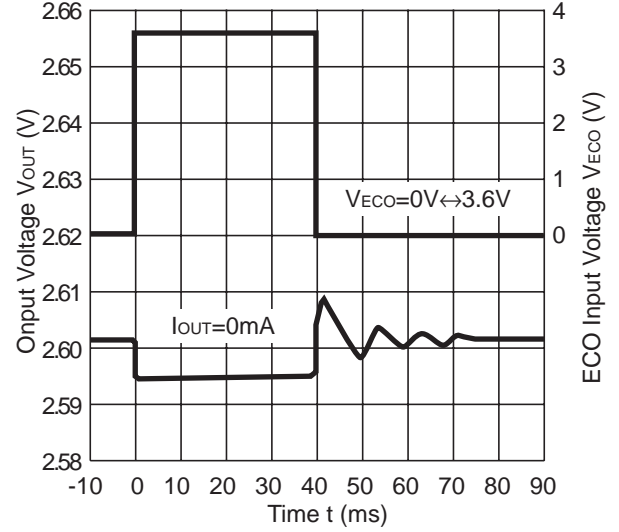

R1161x

TECHNICAL NOTES

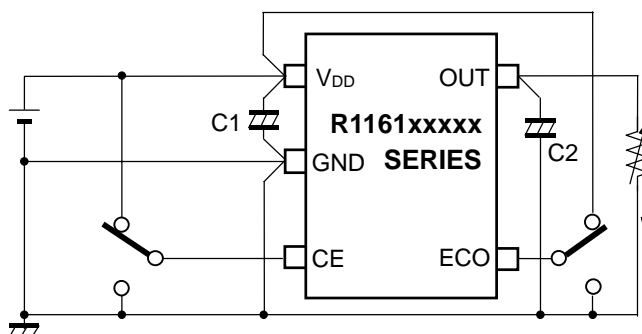

When using these ICs, consider the following points:

1. Mounting on PCB

Make V_{DD} and GND lines sufficient. If their impedance is high, noise pickup or unstable operation may result. Connect a capacitor C1 with as much as $1.0\mu\text{F}$ capacitor between V_{DD} and GND pin as close as possible.

Set external components, especially the output capacitor as close as possible to the ICs and make wiring as short as possible.

2. Phase Compensation

In these ICs, phase compensation is made for securing stable operation even if the load current is varied. For this purpose, be sure to use a $1.0\mu\text{F}$ more capacitor C2 with good frequency characteristics and ESR (Equivalent Series Resistance).

Output Voltage	Recommended Value of C2
$V_{OUT} < 1.0\text{V}$	$1.0\mu\text{F}$ or more Tantalum Capacitor
$1.0\text{V} \leq V_{OUT}$	$1.0\mu\text{F}$ or more Ceramic Capacitor

(Note: When the additional ceramic capacitors are connected to the Output Pin with Output capacitor for phase compensation, the operation might be unstable. Because of this, test these ICs with as same external components as ones to be used on the PCB.)

If you use a tantalum type capacitor and ESR value of the capacitor is large, output might be unstable. Evaluate your circuit with considering frequency characteristics.

Depending on the capacitor size, manufacturer, and part number, the bias characteristics and temperature characteristics are different. Evaluate the circuit with actual using capacitors.

ESR vs. Output Current

When using these ICs, consider the following points:

In these ICs, phase compensation is made for securing stable operation even if the output current is varied. For this purpose, be sure to use a capacitor C_{OUT} with good frequency characteristics and ESR (Equivalent Series Resistance) in the range described as follows:

The relations between I_{OUT} (Output Current) and ESR of Output Capacitor are shown below.

The conditions when the white noise level is under $40\mu\text{V}$ (Avg.) are marked as the hatched area in the graph.

<Test conditions>

- (1) Frequency band: 10Hz to 2MHz
- (2) Temperature: 25°C

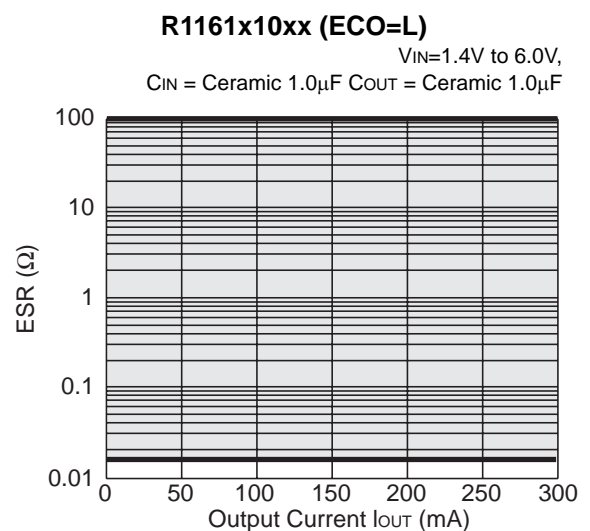
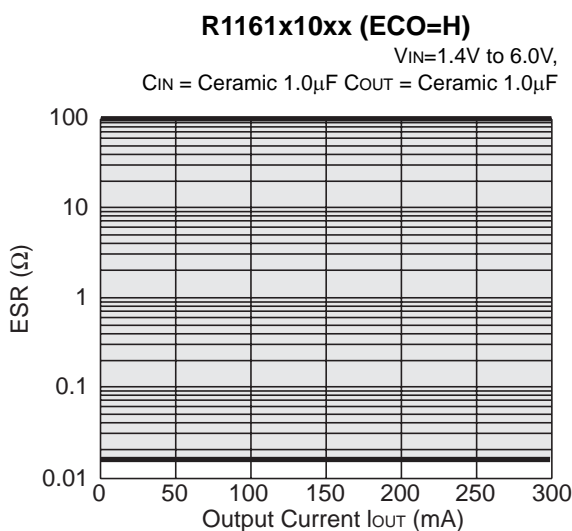
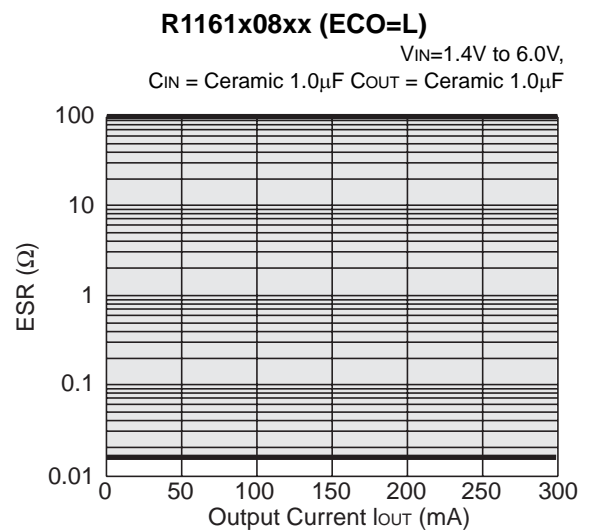
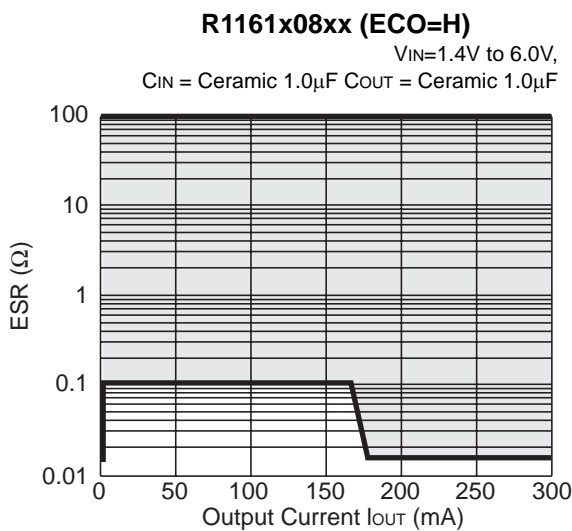

* R1116Dxx1 (SON-6) and R1116Dxx2 (HSO6-6) products are the discontinued product. As of March in 2018.

R1161x

R1161x26xx (ECO=H)

$V_{IN}=3.0V$ to $6.0V$,
 C_{IN} = Ceramic $1.0\mu F$ C_{OUT} = Ceramic $1.0\mu F$

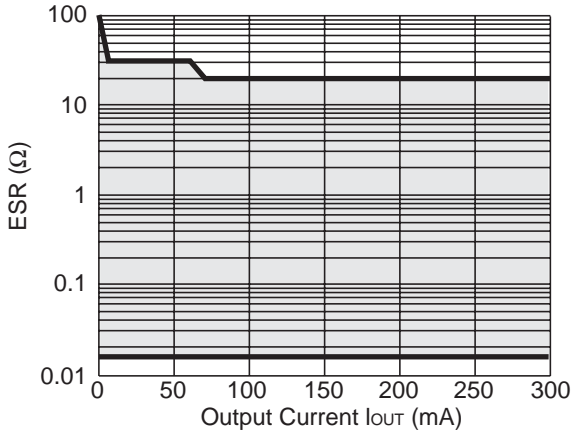

R1161x26xx (ECO=L)

$V_{IN}=3.0V$ to $6.0V$,
 C_{IN} = Ceramic $1.0\mu F$ C_{OUT} = Ceramic $1.0\mu F$

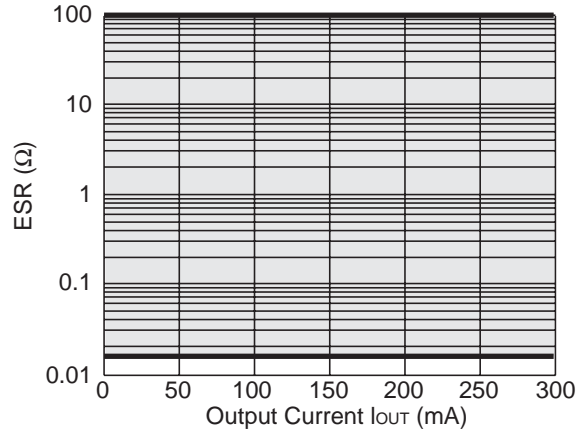

R1161x15xx (ECO=H)

$V_{IN}=2.0V$ to $6.0V$,
 C_{IN} = Ceramic $1.0\mu F$ C_{OUT} = Ceramic $1.0\mu F$

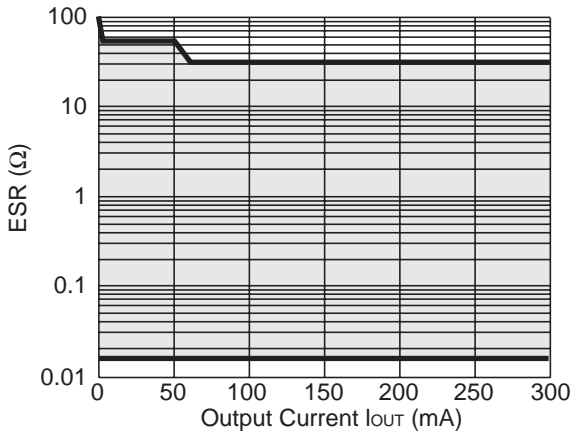

R1161x30xx (ECO=H)

$V_{IN}=3.6V$ to $6.0V$,
 C_{IN} = Ceramic $1.0\mu F$ C_{OUT} = Ceramic $1.0\mu F$

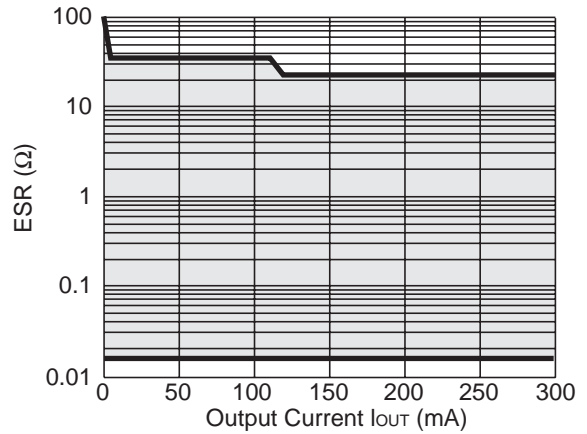



1. The products and the product specifications described in this document are subject to change or discontinuation of production without notice for reasons such as improvement. Therefore, before deciding to use the products, please refer to Ricoh sales representatives for the latest information thereon.
2. The materials in this document may not be copied or otherwise reproduced in whole or in part without prior written consent of Ricoh.
3. Please be sure to take any necessary formalities under relevant laws or regulations before exporting or otherwise taking out of your country the products or the technical information described herein.
4. The technical information described in this document shows typical characteristics of and example application circuits for the products. The release of such information is not to be construed as a warranty of or a grant of license under Ricoh's or any third party's intellectual property rights or any other rights.
5. The products listed in this document are intended and designed for use as general electronic components in standard applications (office equipment, telecommunication equipment, measuring instruments, consumer electronic products, amusement equipment etc.). Those customers intending to use a product in an application requiring extreme quality and reliability, for example, in a highly specific application where the failure or misoperation of the product could result in human injury or death (aircraft, spacevehicle, nuclear reactor control system, traffic control system, automotive and transportation equipment, combustion equipment, safety devices, life support system etc.) should first contact us.
6. We are making our continuous effort to improve the quality and reliability of our products, but semiconductor products are likely to fail with certain probability. In order to prevent any injury to persons or damages to property resulting from such failure, customers should be careful enough to incorporate safety measures in their design, such as redundancy feature, fire containment feature and fail-safe feature. We do not assume any liability or responsibility for any loss or damage arising from misuse or inappropriate use of the products.
7. Anti-radiation design is not implemented in the products described in this document.
8. The X-ray exposure can influence functions and characteristics of the products. Confirm the product functions and characteristics in the evaluation stage.
9. WLCSP products should be used in light shielded environments. The light exposure can influence functions and characteristics of the products under operation or storage.
10. There can be variation in the marking when different AOI (Automated Optical Inspection) equipment is used. In the case of recognizing the marking characteristic with AOI, please contact Ricoh sales or our distributor before attempting to use AOI.
11. Please contact Ricoh sales representatives should you have any questions or comments concerning the products or the technical information.



Ricoh is committed to reducing the environmental loading materials in electrical devices with a view to contributing to the protection of human health and the environment.

Ricoh has been providing RoHS compliant products since April 1, 2006 and Halogen-free products since April 1, 2012.

RICOH RICOH ELECTRONIC DEVICES CO., LTD.

<https://www.e-devices.ricoh.co.jp/en/>

Sales & Support Offices

Ricoh Electronic Devices Co., Ltd.

Shin-Yokohama Office (International Sales)

2-3, Shin-Yokohama 3-chome, Kohoku-ku, Yokohama-shi, Kanagawa, 222-8530, Japan
Phone: +81-50-3814-7687 Fax: +81-45-474-0074

Ricoh Americas Holdings, Inc.

675 Campbell Technology Parkway, Suite 200 Campbell, CA 95008, U.S.A.
Phone: +1-408-610-3105

Ricoh Europe (Netherlands) B.V.

Semiconductor Support Centre

Prof. W.H. Keesomlaan 1, 1183 DJ Amstelveen, The Netherlands
Phone: +31-20-5474-309

Ricoh International B.V. - German Branch

Semiconductor Sales and Support Centre

Oberrather Strasse 6, 40472 Düsseldorf, Germany
Phone: +49-211-6546-0

Ricoh Electronic Devices Korea Co., Ltd.

3F, Haesung Bldg, 504, Teheran-ro, Gangnam-gu, Seoul, 135-725, Korea
Phone: +82-2-2135-5700 Fax: +82-2-2051-5713

Ricoh Electronic Devices Shanghai Co., Ltd.

Room 403, No.2 Building, No.690 Bibo Road, Pu Dong New District, Shanghai 201203,
People's Republic of China
Phone: +86-21-5027-3200 Fax: +86-21-5027-3299

Ricoh Electronic Devices Shanghai Co., Ltd.

Shenzhen Branch

1205, Block D (Jinlong Building), Kingkey 100, Hongbao Road, Luohu District,
Shenzhen, China
Phone: +86-755-8348-7600 Ext 225

Ricoh Electronic Devices Co., Ltd.

Taipei office

Room 109, 10F-1, No.51, Hengyang Rd., Taipei City, Taiwan (R.O.C.)
Phone: +886-2-2313-1621/1622 Fax: +886-2-2313-1623