

R58, Class X1, THB Grade IIIB, 600 VAC, 110°C (Automotive Grade)

Overview

The R58 is constructed of metallized polypropylene film encapsulated with self-extinguishing resin in a box of material meeting the requirements of UL 94 V-0.

Automotive Grade devices meet the demanding Automotive Electronics Council's AEC-Q200 qualification requirements.

Applications

For worldwide use in electromagnetic interference (EMI) suppression in across-the-line applications that require X1 safety classification. Typical applications include Industrial, Solar inverter output EMI filtering and Automotive HV DC bus filtering.

Benefits

- Approvals: ENEC, UL, cUL, CQC
- Class X1 (IEC 60384-14)
- THB Grade IIIB: 85°C, 85% RH, 1,000 hours at 600 VAC acc. to IEC 60384-14
- THB Grade IIIB: 85°C, 85% RH, 1,000 hours at 1,200 VDC acc. to IEC 60384-14
- Low Halogen Content according to JS709C
- Rated AC voltage: 600 VAC 50/60 Hz
- Rated DC voltage: 1,200 VDC
- Capacitance range: 0.01 – 8.2 μ F
- Lead spacing: 15.0 – 52.5 mm
- Capacitance tolerance: \pm 20%, \pm 10%
- Climatic category 40/110/56, IEC 60068-1
- Tape and reel in accordance with IEC 60286-2
- RoHS compliant and lead-free terminations
- Operating temperature range of -40°C to +110°C
- 100% screening factory test at 3,000 VDC
- Self-healing properties
- Automotive (AEC-Q200) grade



Customer Part Number

R58	6	I	2470	00	T0	M
Series	Rated Voltage (VAC)	Lead Spacing (mm)	Capacitance Code (pF)	Packaging	Internal Use	Capacitance Tolerance
X1, Metallized Polypropylene	6 = 600	I = 15.0 N = 22.5 R = 27.5 W = 37.5 Y = 52.5	The last three digits represent significant figures. The first digit specifies number of zeros to be added.	See Ordering Options Table	T0 T1	K = \pm 10% M = \pm 20%

Ordering Options Table

Lead Spacing Nominal (mm)	Type of Leads and Packaging	LL Lead Length (mm)	Lead and Packaging Code
15 22.5	Standard Lead and Packaging Options		
	Bulk (Bag) – Short Leads	4.0 +2/-0	00
	Pizza Pack – Short Leads	4.0 +2/-0	BB
	Ammo Pack	H ₀ = 18.5 ±0.5	DQ ¹
	Other Lead and Packaging Options		
	Tape & Reel (Large Reel)	H ₀ = 18.5 ±0.5	CK
	Tape & Reel (Standard Reel)	H ₀ = 18.5 ±0.5	GY ¹
	Bulk (Bag) ² – Short Leads	2.7 +0.5/-0	JA
	Bulk (Bag) ² – Short Leads	3.5 +0.5/-0	JB
	Bulk (Bag) ² – Short Leads	4.0 +0.5/-0	JE
	Bulk (Bag) ² – Short Leads	3.2 +0.3/-0.2	JH
	Bulk (Bag) – Long Leads	18 ±1	JM
	Bulk (Bag) – Long Leads	30 +5/-0	40
Bulk (Bag) – Long Leads	25 +2/-1	50	
27.5	Standard Lead and Packaging Options		
	Bulk (Tray) – Short Leads	4.0 +2/-0	00
	Pizza Pack – Short Leads	4.0 +2/-0	BB
	Tape & Reel (Large Reel)	H ₀ = 18.5 ±0.5	CK ¹
	Other Lead and Packaging Options		
	Bulk (Tray) – Short Leads	2.7 +0.5/-0	JA
	Bulk (Tray) – Short Leads	3.5 +0.5/-0	JB
	Bulk (Tray) – Short Leads	4.0 +0.5/-0	JE
	Bulk (Tray) – Short Leads	3.2 +0.3/-0.2	JH
	Bulk (Tray) – Long Leads	18 ±1	JM
	Bulk (Tray) – Long Leads	30 +5/-0	40
	Bulk (Tray) – Long Leads	25 +2/-1	50

¹ Not for all sizes, see "Packaging Quantities" table.

² For lead spacing 22.5 case sizes ≥ 8.5*17*26.5 the parts are packed in Pizza box 335*320*34 mm.

Ordering Options Table cont.

Lead Spacing Nominal (mm)	Type of Leads and Packaging	LL Lead Length (mm)	Lead and Packaging Code
37.5	Standard Lead and Packaging Options		
	Pizza Pack – Short Leads	4.0 +2/-0	00
	Other Lead and Packaging Options		
	Pizza Pack – Short Leads	2.7 +0.5/-0	JA
	Pizza Pack – Short Leads	3.5 +0.5/-0	JB
	Pizza Pack – Short Leads	4.0 +0.5/-0	JE
	Pizza Pack – Short Leads	3.2 +0.3/-0.2	JH
	Pizza Pack – Long Leads	18 ±1	JM
	Pizza Pack – Long Leads	30 +5/-0	40
	Pizza Pack – Long Leads	25 +2/-1	50
52.5	Standard Lead and Packaging Options		
	Pizza Pack – Short Leads	4.0 +2/-0	00

1 Not for all sizes, see "Packaging Quantities" table.

2 For lead spacing 22.5 case sizes $\geq 8.5 \times 17 \times 26.5$ the parts are packed in Pizza box $335 \times 320 \times 34$ mm.

Dimensions – Millimeters

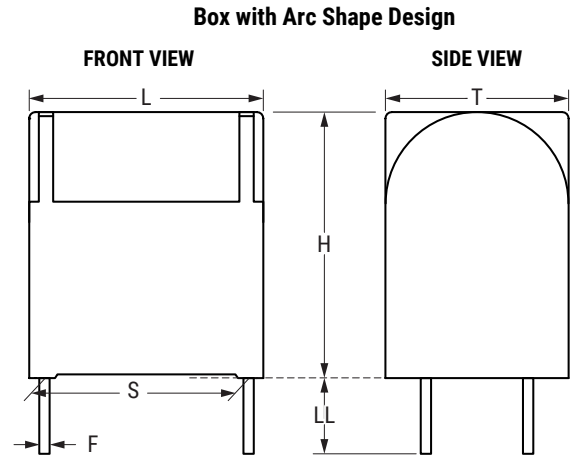
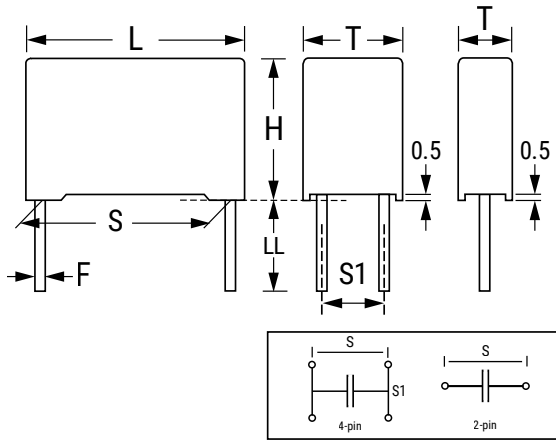

S		S1		T		H		L		F	
Nominal	Tolerance	Nominal	Tolerance	Nominal	Tolerance	Nominal	Tolerance	Nominal	Tolerance	Nominal	Tolerance
15.0	±0.4	-	-	5.0	+0.3/-0.5	11.0	+0.3/-0.5	18.0	+0.5/-0.5	0.6	±0.05
15.0	±0.4	-	-	6.0	+0.3/-0.5	12.0	+0.3/-0.5	18.0	+0.5/-0.5	0.6	±0.05
15.0	±0.4	-	-	7.5	+0.3/-0.5	13.5	+0.3/-0.5	18.0	+0.5/-0.5	0.6	±0.05
15.0	±0.4	-	-	8.5	+0.3/-0.5	14.5	+0.3/-0.5	18.0	+0.5/-0.5	0.6	±0.05
15.0	±0.4	-	-	10.0	+0.3/-0.5	16.0	+0.3/-0.5	18.0	+0.5/-0.5	0.8	±0.05
15.0	±0.4	-	-	11.0	+0.3/-0.5	19.0	+0.3/-0.5	18.0	+0.5/-0.5	0.8	±0.05
22.5	±0.4	-	-	6.0	+0.3/-0.5	15.0	+0.3/-0.5	26.5	+0.5/-0.5	0.8	±0.05
22.5	±0.4	-	-	7.0	+0.3/-0.5	16.0	+0.3/-0.5	26.5	+0.5/-0.5	0.8	±0.05
22.5	±0.4	-	-	8.5	+0.3/-0.5	17.0	+0.3/-0.5	26.5	+0.5/-0.5	0.8	±0.05
22.5	±0.4	-	-	10.0	+0.3/-0.5	18.5	+0.3/-0.5	26.5	+0.5/-0.5	0.8	±0.05
22.5	±0.4	-	-	11.0	+0.3/-0.5	20.0	+0.3/-0.5	26.5	+0.5/-0.5	0.8	±0.05
22.5	±0.4	-	-	13.0	+0.3/-0.5	22.0	+0.3/-0.5	26.5	+0.5/-0.5	0.8	±0.05
27.5	±0.4	-	-	11.0	+0.3/-0.7	20.0	+0.3/-0.7	32.0	+0.5/-0.7	0.8	±0.05
27.5	±0.4	-	-	13.0	+0.3/-0.7	22.0	+0.3/-0.7	32.0	+0.5/-0.7	0.8	±0.05
27.5	±0.4	-	-	14.0	+0.3/-0.7	28.0	+0.3/-0.7	32.0	+0.5/-0.7	0.8	±0.05
27.5	±0.4	-	-	18.0	+0.3/-0.7	33.0	+0.3/-0.7	32.0	+0.5/-0.7	0.8	±0.05
27.5	±0.4	-	-	22.0	+0.3/-0.7	37.0	+0.3/-0.7	32.0	+0.5/-0.7	0.8	±0.05
37.5	±0.4	-	-	11.0	+0.3/-0.7	22.0	+0.3/-0.7	42.0	+0.5/-0.7	1.0	±0.05
37.5	±0.4	-	-	13.0	+0.3/-0.7	24.0	+0.3/-0.7	42.0	+0.5/-0.7	1.0	±0.05
37.5	±0.4	-	-	16.0	+0.3/-0.7	28.5	+0.3/-0.7	42.0	+0.5/-0.7	1.0	±0.05
37.5	±0.4	-	-	19.0	+0.3/-0.7	32.0	+0.3/-0.7	42.0	+0.5/-0.7	1.0	±0.05
37.5	±0.4	-	-	20.0	+0.3/-0.7	40.0	+0.3/-0.7	42.0	+0.5/-0.7	1.0	±0.05
37.5	±0.4	-	-	24.0	+0.3/-0.7	44.0	+0.3/-0.7	42.0	+0.5/-0.7	1.0	±0.05
37.5	±0.4	-	-	30.0	+0.3/-0.7	45.0	+0.3/-0.7	42.0	+0.5/-0.7	1.0	±0.05
52.5	±0.4	20.3	±0.4	30.0	+1.2/-1.2	45.0	+1.2/-1.2	57.5	+1.2/-1.2	1.2	±0.05
52.5	±0.4	20.3	±0.4	35.0	+1.2/-1.2	50.0	+1.2/-1.2	57.5	+1.2/-1.2	1.2	±0.05
52.5*	±0.4	20.3	±0.4	45.0	+1.2/-1.2	56.0	+1.2/-1.2	57.5	+1.2/-1.2	1.2	±0.05

Note: See the Ordering Options Table for lead length (LL) options.

* Box with Arc Shape Design

Performance Characteristics

Dielectric	Polypropylene film		
Plates	Metal layer deposited by evaporation under vacuum		
Winding	Non-inductive type		
Leads	Tinned wire		
Protection	Plastic case, thermosetting resin-filled. Box material is solvent resistant and flame retardant according to UL94.		
Related Documents	IEC 60384-14, EN 60384-14		
Rated Voltage V_R	600 VAC (50/60 Hz) / 1,200 VDC		
Capacitance Range	0.01 – 8.2 μ F		
Capacitance Values	E6 series (IEC 60063) measured at 1 kHz and +20 \pm 1°C		
Capacitance Tolerance	\pm 10%, \pm 20%		
Temperature Range	-40°C to 110°C		
Climatic Category	40/110/56 IEC 60068-1		
Storage Conditions	Storage time: \leq 24 months from the date marked on the label package		
	Average relative humidity per year \leq 70%		
	RH \leq 85% for 30 days randomly distributed throughout the year		
	Dew is absent		
Approvals	Temperature: -40 to 80°C (see "Maximum Humidity in Storage Conditions" graph below)		
	ENEC, UL, cUL, CQC (in progress)		
Dissipation Factor ($\tan\delta$) at 1 kHz	Maximum Values at +25°C \pm 5°C		
	Pitch = 15 mm	Pitch = 22.5 or 27.5 mm	Pitch = 37.5 or 52.5 mm
	0.4%	0.3%	0.2%
Test Voltage Between Terminations	The 100% screening factory test is carried out at 3,000 VDC. The voltage level is selected to meet the requirements in applicable equipment standards. All electrical characteristics are checked after the test. It is not permitted to repeat this test as there is a risk to damage the capacitor. KEMET is not liable in such case for any failures.		
Insulation Resistance	Measured at +25°C \pm 5°C		
	Minimum Values Between Terminals		
	Voltage Charge	Voltage Charge Time	C \leq 0.33 μ F
	500 VDC	1 minute	C > 0.33 μ F
		$\geq 1 \cdot 10^5 \text{ M}\Omega$ ($\geq 5 \cdot 10^5 \text{ M}\Omega$)*	$\geq 30,000 \text{ M}\Omega \cdot \mu\text{F}$ ($\geq 150,000 \text{ M}\Omega \cdot \mu\text{F}$)*

*Typical Value

Performance Characteristics cont.

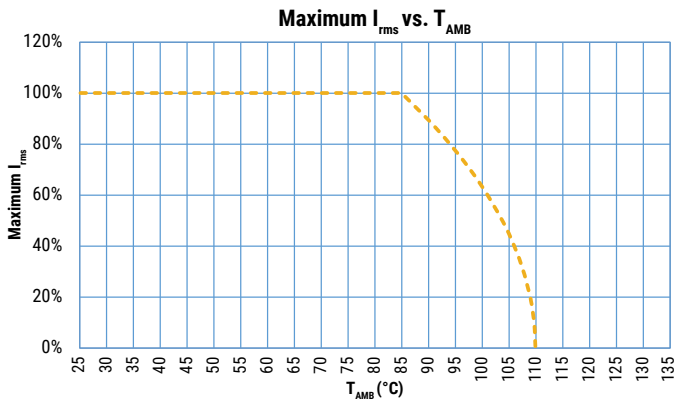
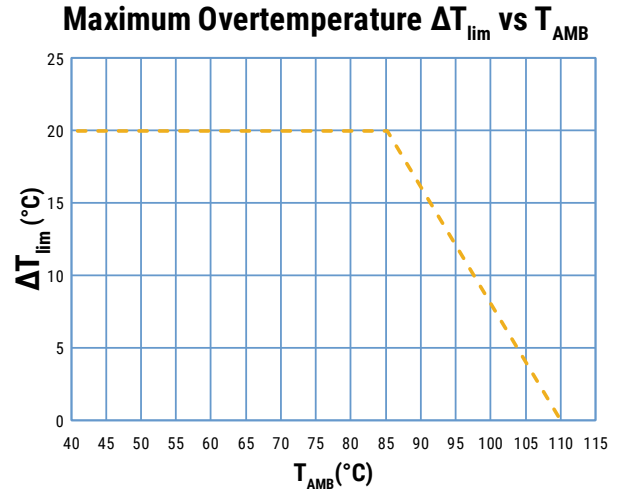
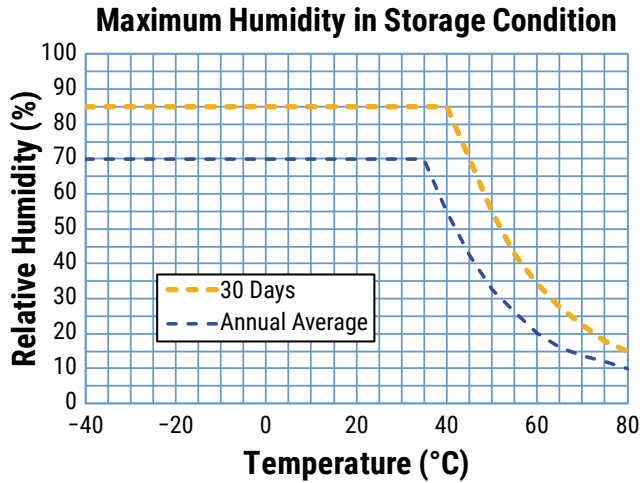

T_{AMB} is the maximum ambient temperature surrounding the capacitor or hottest contact point (e.g. tracks), whichever is higher, in the worst operation conditions in °C.

Qualification

Automotive grade products meet or exceed the requirements outlined by the Automotive Electronics Council. Details regarding test methods and conditions are referenced in document AEC-Q200, Stress Test Qualification for Passive Components. For additional information regarding the Automotive Electronics Council and AEC-Q200, please visit their website at www.aecouncil.com.

Impedance Graph

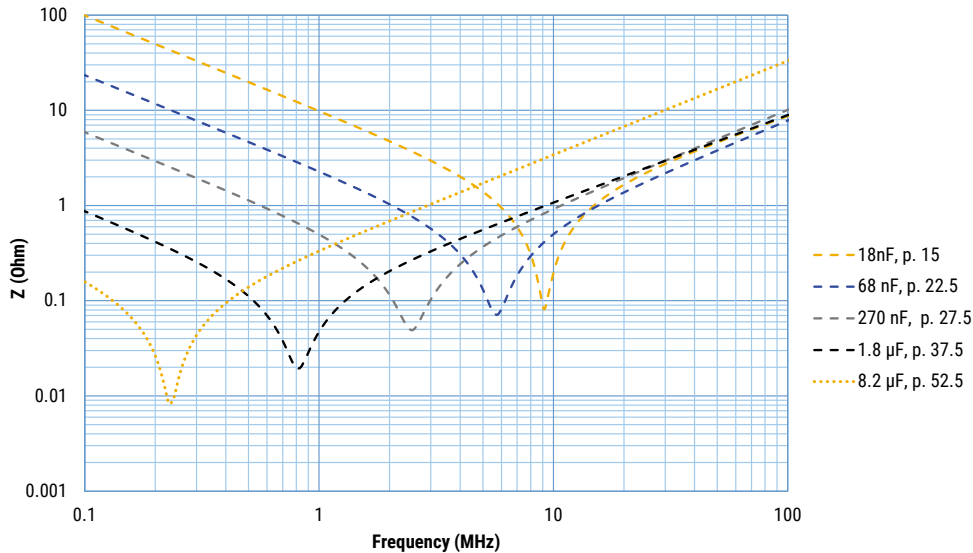

Environmental Test Data

Test	IEC Publication	Procedure
Endurance	IEC 60384-14	1.25 x V _R VAC 50 Hz, once every hour increase to 1,000 VAC for 0.1 second, 1,000 hours at upper rated temperature
Endurance	IEC 60384-14	1.25 x 1200 VDC, 1,000 hours at upper rated temperature
Vibration	MIL-STD-202 Method 204	5 G for 20 minutes, 12 cycles each of 3 orientations. Use 8" X 5" PCB, 0.031" thick. 7 secure points on one 8" side and 2 secure points at corners of opposite sides. Parts mounted within 2" from any secure point. Test from 10 – 2,000 Hz.
Mechanical Shock	MIL-STD-202 Method 213	Figure 1 of Method 213. Condition C
Temperature Cycling	JESD22-Method JA-104	1,000 cycles (-40°C to 110°C) Note: Measurement at 24 ±4 hours after test conclusion. 30 minute maximum dwell time at each temperature extreme. 1 minute maximum transition time.
Active Flammability	IEC 60384-14	V _R + 20 surge pulses at 4 kV (pulse every 5 seconds)
Passive Flammability	IEC 60384-14	IEC 60384-1, IEC 60695-11-5 Needle Flame Test
Biased Humidity	According to Grade IIIB	85°C/85% RH and 600 VAC, 1,000 hours Capacitance change ($\Delta C/C$): $\leq 10\%$ Dissipation factor change ($\Delta \tan \delta$): $\leq 24 * 10^{-3}$ (at 10 kHz) for C $\leq 1 \mu F$ Dissipation factor change ($\Delta \tan \delta$): $\leq 15 * 10^{-3}$ (at 1 kHz) for C $> 1 \mu F$ Insulation resistance Rins or time constant $\tau = CR$ Rins: $\geq 50\%$ of initial limit
Biased Humidity	According to Grade IIIB	85°C/85% RH and 1200 VDC, 1,000 hours Capacitance change ($\Delta C/C$): $\leq 10\%$ Dissipation factor change ($\Delta \tan \delta$): $\leq 24 * 10^{-3}$ (at 10 kHz) for C $\leq 1 \mu F$ Dissipation factor change ($\Delta \tan \delta$): $\leq 15 * 10^{-3}$ (at 1 kHz) for C $> 1 \mu F$ Insulation resistance Rins or time constant $\tau = CR$ Rins: $\geq 50\%$ of initial limit

Maximum Voltage (V_{RMS}) Versus Frequency (Sinusoidal Waveform/ $Th \leq 85^\circ C$)

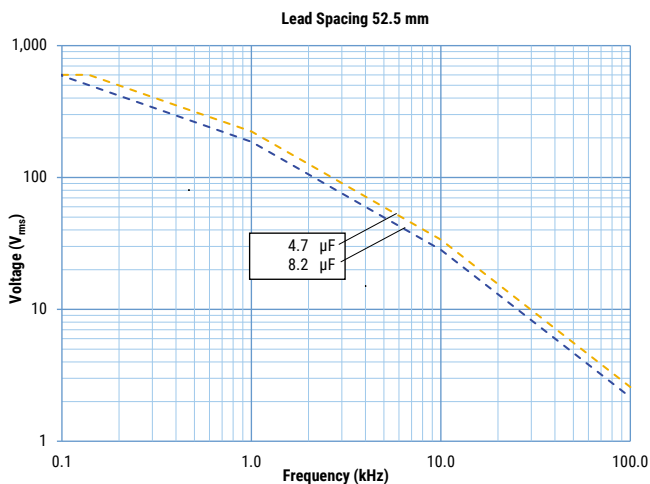
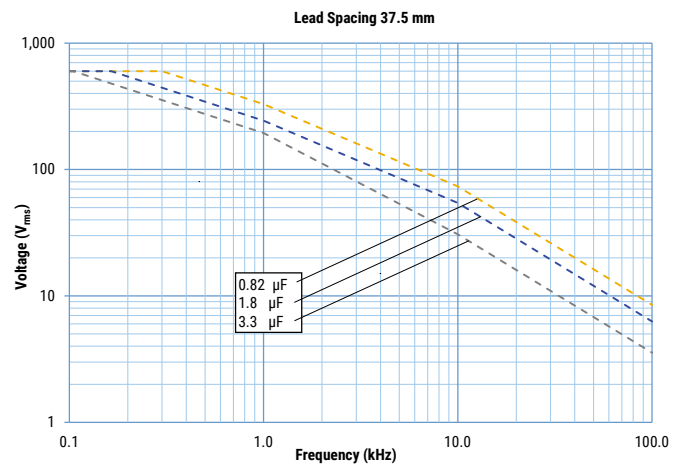
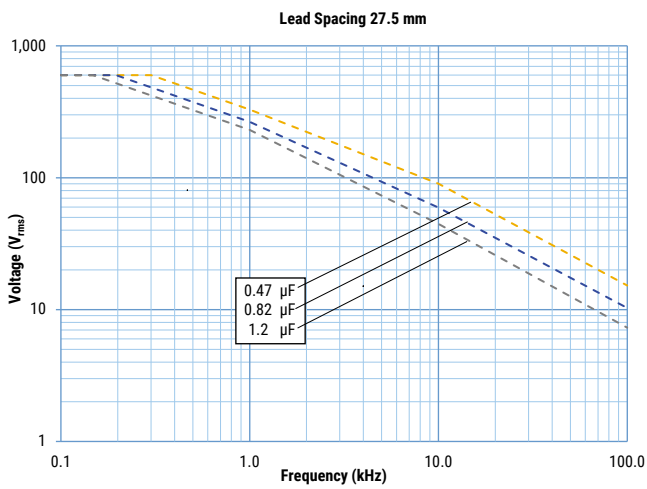
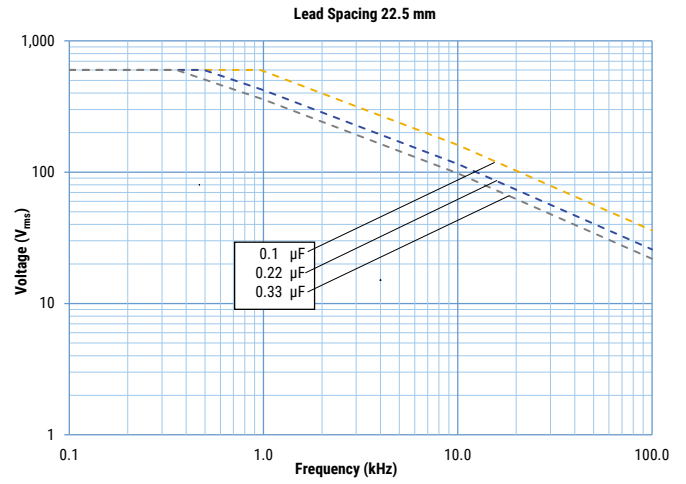
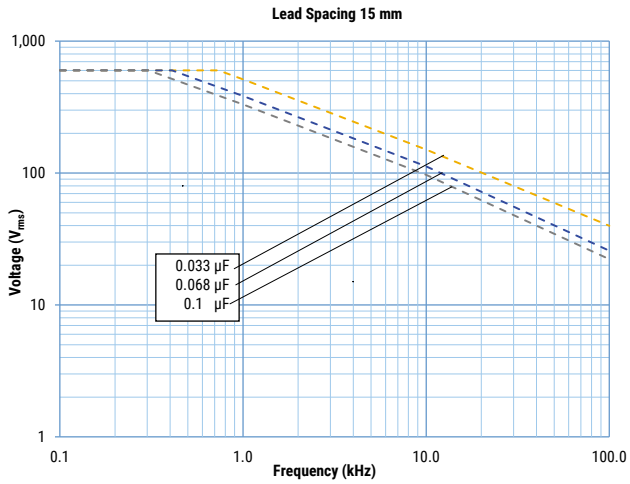

Maximum Current (I_{RMS}) Versus Frequency (Sinusoidal Waveform/ $T_h \leq 85^\circ C$)

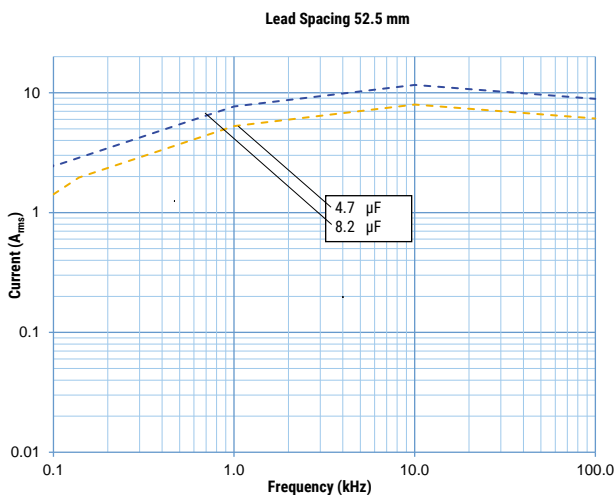
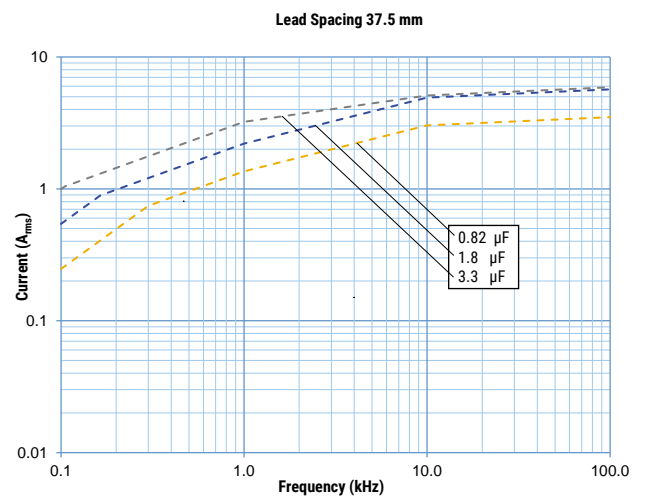
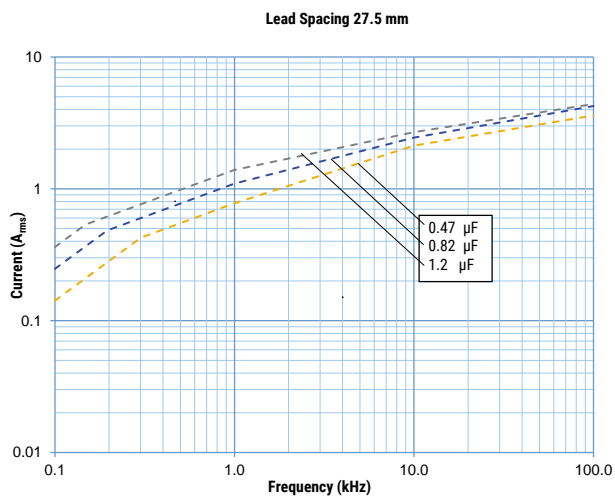
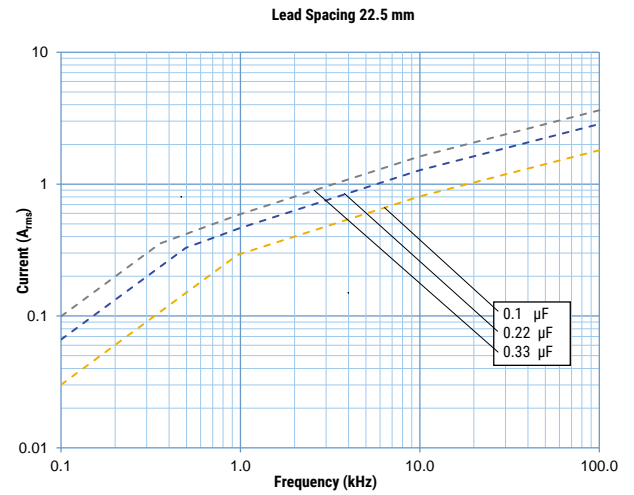
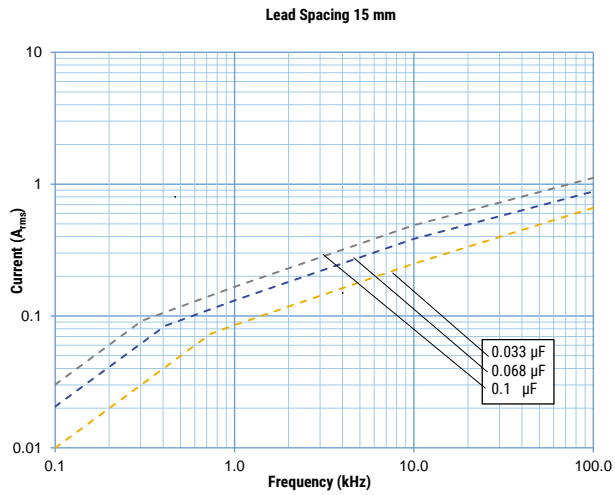

Environmental Compliance

All KEMET EMI capacitors are RoHS compliant.



Approvals

Certification Body	Mark	Specification	File Number
IMQ S.p.A.		EN/IEC 60384-14	CA08.00241
UL		UL 60384-14 and CAN/ CSA-E60384-14	E97797
CQC		IEC 60384-14	CQC23001378656 CQC23001378657 CQC23001378658 CQC23001378659 CQC23001378660

Table 1 – Ratings & Part Number Reference

Capacitance Value (µF)	Dimensions in mm			Lead Spacing (S)	dV/dt (V/µs)	KEMET Part Number	Customer Part Number
	T	H	L				
0.01	5.0	11.0	18.0	15.0	600	586I2100(1)T0(2)	R586I2100(1)T0(2)
0.012	5.0	11.0	18.0	15.0	600	586I2120(1)T0(2)	R586I2120(1)T0(2)
0.015	5.0	11.0	18.0	15.0	600	586I2150(1)T0(2)	R586I2150(1)T0(2)
0.018	6.0	12.0	18.0	15.0	600	586I2180(1)T0(2)	R586I2180(1)T0(2)
0.022	6.0	12.0	18.0	15.0	600	586I2220(1)T0(2)	R586I2220(1)T0(2)
0.027	7.5	13.5	18.0	15.0	600	586I2270(1)T0(2)	R586I2270(1)T0(2)
0.033	7.5	13.5	18.0	15.0	600	586I2330(1)T0(2)	R586I2330(1)T0(2)
0.039	7.5	13.5	18.0	15.0	600	586I2390(1)T0(2)	R586I2390(1)T0(2)
0.047	8.5	14.5	18.0	15.0	600	586I2470(1)T0(2)	R586I2470(1)T0(2)
0.056	10.0	16.0	18.0	15.0	600	586I2560(1)T0(2)	R586I2560(1)T0(2)
0.068	10.0	16.0	18.0	15.0	600	586I2680(1)T0(2)	R586I2680(1)T0(2)
0.082	11.0	19.0	18.0	15.0	600	586I2820(1)T0(2)	R586I2820(1)T0(2)
0.10	11.0	19.0	18.0	15.0	600	586I3100(1)T0(2)	R586I3100(1)T0(2)
0.047	6.0	15.0	26.5	22.5	300	586N2470(1)T0(2)	R586N2470(1)T0(2)
0.056	6.0	15.0	26.5	22.5	300	586N2560(1)T0(2)	R586N2560(1)T0(2)
0.068	6.0	15.0	26.5	22.5	300	586N2680(1)T0M	R586N2680(1)T0M
0.082	7.0	16.0	26.5	22.5	300	586N2820(1)T0(2)	R586N2820(1)T0(2)
0.10	8.5	17.0	26.5	22.5	300	586N3100(1)T0(2)	R586N3100(1)T0(2)
0.12	8.5	17.0	26.5	22.5	300	586N3120(1)T0(2)	R586N3120(1)T0(2)
0.15	10.0	18.5	26.5	22.5	300	586N3150(1)T0(2)	R586N3150(1)T0(2)
0.18	10.0	18.5	26.5	22.5	300	586N3180(1)T0(2)	R586N3180(1)T0(2)
0.22	11.0	20.0	26.5	22.5	300	586N3220(1)T0(2)	R586N3220(1)T0(2)
0.27	13.0	22.0	26.5	22.5	300	586N3270(1)T0(2)	R586N3270(1)T0(2)
0.33	13.0	22.0	26.5	22.5	300	586N3330(1)T0M	R586N3330(1)T0M
0.22	11.0	20.0	32.0	27.5	225	586R3220(1)T0(2)	R586R3220(1)T0(2)
0.27	13.0	22.0	32.0	27.5	225	586R3270(1)T0(2)	R586R3270(1)T0(2)
0.33	13.0	22.0	32.0	27.5	225	586R3330(1)T0(2)	R586R3330(1)T0(2)
0.39	14.0	28.0	32.0	27.5	225	586R3390(1)T0(2)	R586R3390(1)T0(2)
0.47	14.0	28.0	32.0	27.5	225	586R3470(1)T0(2)	R586R3470(1)T0(2)
0.56	14.0	28.0	32.0	27.5	225	586R3560(1)T0M	R586R3560(1)T0M
0.68	18.0	33.0	32.0	27.5	225	586R3680(1)T0(2)	R586R3680(1)T0(2)
0.82	18.0	33.0	32.0	27.5	225	586R3820(1)T0(2)	R586R3820(1)T0(2)
1.0	18.0	33.0	32.0	27.5	225	586R4100(1)T0M	R586R4100(1)T0M
1.2	22.0	37.0	32.0	27.5	225	586R4120(1)T0(2)	R586R4120(1)T0(2)
0.47	11.0	22.0	42.0	37.5	150	586W3470(1)T0M	R586W3470(1)T0M
0.56	13.0	24.0	42.0	37.5	150	586W3560(1)T0(2)	R586W3560(1)T0(2)
0.68	13.0	24.0	42.0	37.5	150	586W3680(1)T0M	R586W3680(1)T0M
0.82	16.0	28.5	42.0	37.5	150	586W3820(1)T0(2)	R586W3820(1)T0(2)
1.0	16.0	28.5	42.0	37.5	150	586W4100(1)T0M	R586W4100(1)T0M
1.2	19.0	32.0	42.0	37.5	150	586W4120(1)T0(2)	R586W4120(1)T0(2)
1.5	20.0	40.0	42.0	37.5	150	586W4150(1)T0(2)	R586W4150(1)T0(2)
1.8	20.0	40.0	42.0	37.5	150	586W4180(1)T0(2)	R586W4180(1)T0(2)
2.2	24.0	44.0	42.0	37.5	150	586W4220(1)T0(2)	R586W4220(1)T0(2)
2.7	24.0	44.0	42.0	37.5	150	586W4270(1)T0(2)	R586W4270(1)T0(2)
3.3	30.0	45.0	42.0	37.5	150	586W4330(1)T0(2)	R586W4330(1)T0(2)
4.7	30.0	45.0	57.5	52.5	76	586Y4470(1)T0(2)	R586Y4470(1)T0(2)
5.6	30.0	45.0	57.5	52.5	76	586Y4560(1)T0(2)	R586Y4560(1)T0(2)
6.8	35.0	50.0	57.5	52.5	76	586Y4680(1)T0(2)	R586Y4680(1)T0(2)
8.2	45.0	56.0	57.5	52.5	76	586Y4820(1)T0(2)	R586Y4820(1)T0(2)
Capacitance Value (µF)	T (mm)	H (mm)	L (mm)	Lead Spacing (S)	dV/dt (V/µs)	KEMET Part Number	Customer Part Number

(1) Insert lead and packaging code. See table for available options.

(2) M = ±20%, K = ±10%

Soldering Process

The implementation of the RoHS directive has resulted in the selection of SnAuCu (SAC) alloys or SnCu alloys as primary solder. This has increased the liquidus temperature from 183°C for SnPb eutectic alloys to 217 – 221°C for the new alloys. As a result, the heat stress to the components, even in wave soldering, has increased considerably due to higher pre-heat and wave temperatures. Polypropylene capacitors are especially sensitive to heat (the melting point of polypropylene is 160 – 170°C). Wave soldering can be destructive, especially for mechanically small polypropylene capacitors (with lead spacing of 5 – 15 mm), and great care must be taken during soldering. The recommended solder profiles from KEMET should be used. Please consult KEMET with any questions. In general, the wave soldering curve from IEC Publication 61760-1 Edition 2 serves as a solid guideline for successful soldering. See Figure 1.

Reflow soldering is not recommended for through-hole film capacitors. Exposing capacitors to a soldering profile in excess of the recommended limits may result in degradation of or permanent damage to the capacitors.

Do not place the polypropylene capacitor through an adhesive curing oven to cure resin for surface-mount components. Insert through-hole parts after curing the surface mount parts. Consult KEMET to discuss the actual temperature profile in the oven, if through-hole components must pass through the adhesive curing process. A maximum of two soldering cycles is recommended. Allow time for the capacitor surface temperature to return to normal before the second soldering cycle.

Manual Soldering Recommendations

The following is the recommendation for manual soldering with a soldering iron.

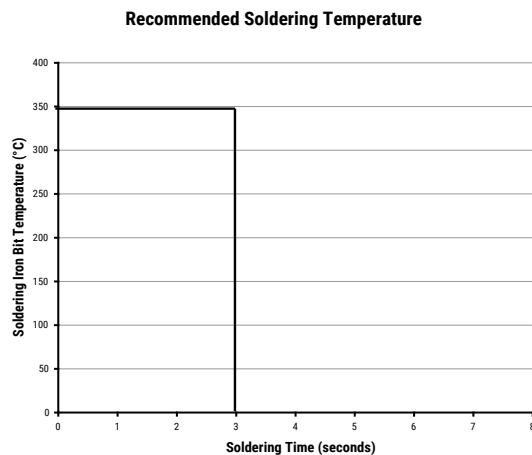

Soldering iron tip temperature should be set at 350°C (+10°C maximum), with the soldering duration not to exceed 3 seconds.

Wave Soldering Recommendations

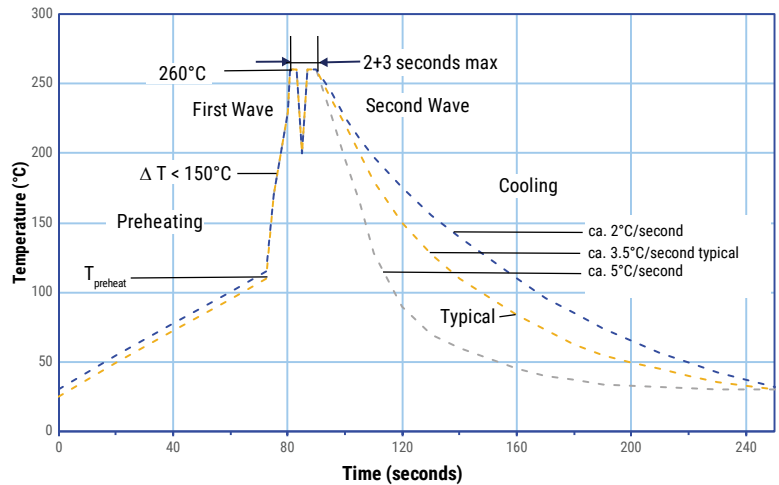

Figure 1

Soldering Process cont.

Wave Soldering Recommendations cont.

1. The table indicates the maximum set-up temperature of the soldering process.
Figure 1

Dielectric Film Material	Maximum Preheat Temperature		Maximum Peak Soldering Temperature	
	Capacitor Pitch ≤ 15 mm	Capacitor Pitch > 15 mm	Capacitor Pitch ≤ 15 mm	Capacitor Pitch > 15 mm
Polyester	130°C	130°C	270°C	270°C
Polypropylene	110°C	130°C	260°C	270°C
Paper	130°C	140°C	270°C	270°C
Polyphenylene Sulphide	150°C	160°C	270°C	270°C

2. The maximum temperature measured inside the capacitor: set the temperature so that the maximum temperature is below the.

Dielectric Film Material	Maximum Temperature Measured Inside the Element
Polyester	160°C
Polypropylene	110°C
Paper	160°C
Polyphenylene Sulphide	160°C

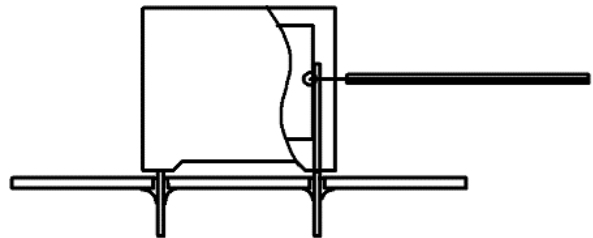

Temperature monitored inside the capacitor.

Selective Soldering Recommendations

Selective dip soldering is a variation of reflow soldering. In this method, the printed circuit board with through-hole components to be soldered is preheated and transported over the solder bath, as in normal flow soldering, without touching the solder. When the board is over the bath, it is stopped. Pre-designed solder pots are lifted from the bath with molten solder only at the places of the selected components, and then pressed against the lower surface of the board to solder the components.

The temperature profile for selective soldering is similar to the double-wave flow soldering outlined in this document. **However, instead of two baths, there is only one with a time from 3 to 10 seconds.** In selective soldering, the risk of overheating is greater than in double-wave flow soldering. Great care must be taken so that the parts do not overheat.

Mounting

Resistance to Vibration and Mechanical Shock

AEC-Q200 Rev. E Mechanical Stress Tests:

Mechanical Shock	MIL-STD-202 Method 213	<p>Figure 1 of Method 213</p> <ul style="list-style-type: none"> • THT: Condition C • SMD: Condition C • Tested per the Supplier’s recommended mounting method
Vibration	MIL-STD-202 Method 204	<ul style="list-style-type: none"> • 5 g for 20 minutes, 12 cycles each of 3 orientations • Tested per the Supplier’s recommended mounting method • Verification of transfer load: during setup, verify that with the selected PCB design (size, thickness and secure points), or an alternative mount, that the transferred load onto the component corresponds to the requested load. This verification can be achieved using a laser vibrometer or other adequate measuring device • Test from 10 Hz – 2,000 Hz.

The capacitors are designed for PCB mounting. The stand-off pipes must be in good contact with the printed circuit board. The capacitor body has to be properly fixed (e.g. clamped or glued).

Construction

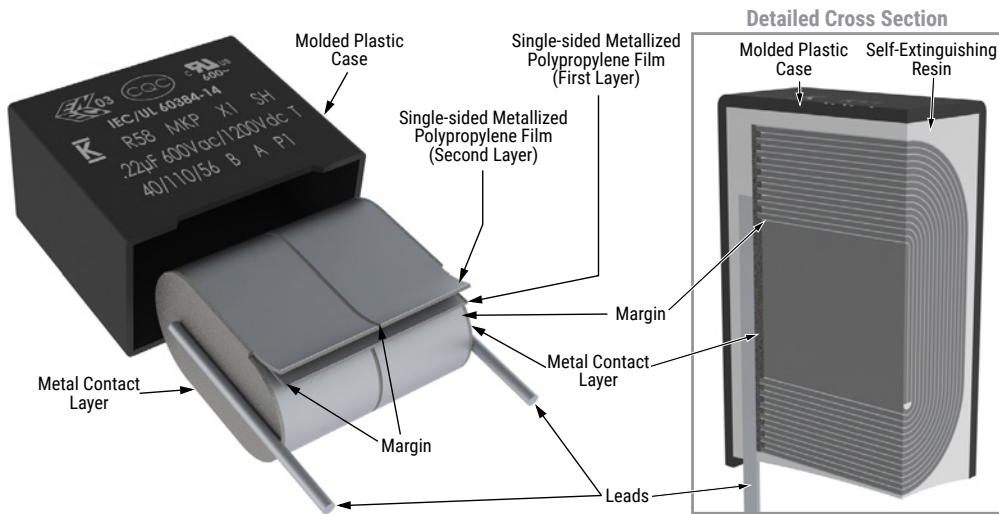

Winding Scheme

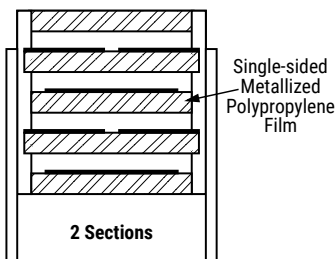

Construction cont.

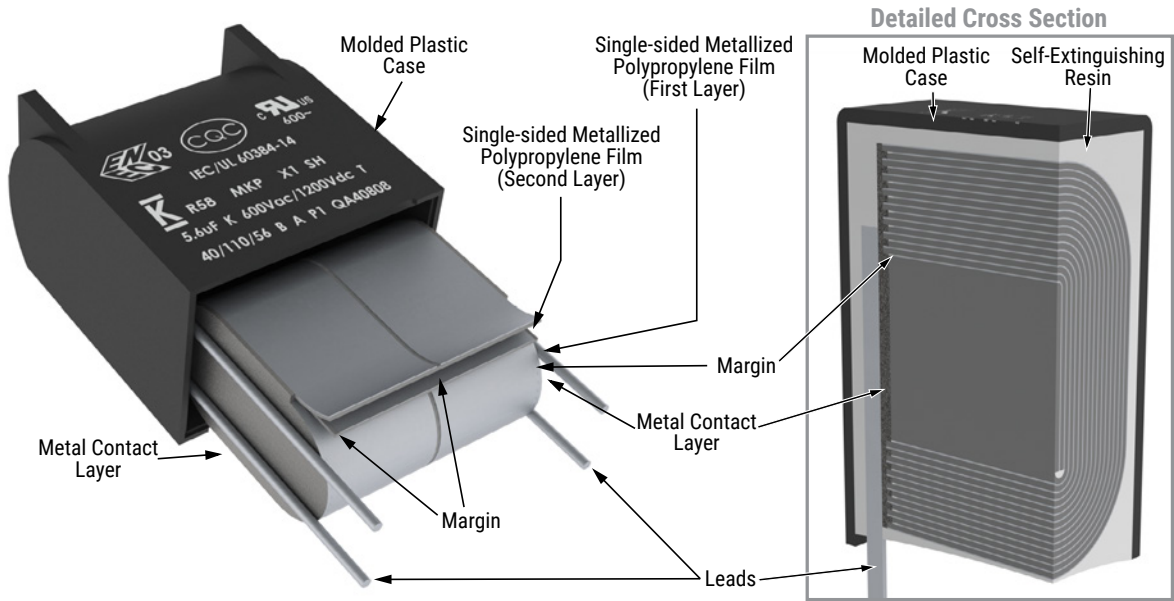

Marking

Lead Spacing 15 mm, 22.5 mm, and 27.5 mm

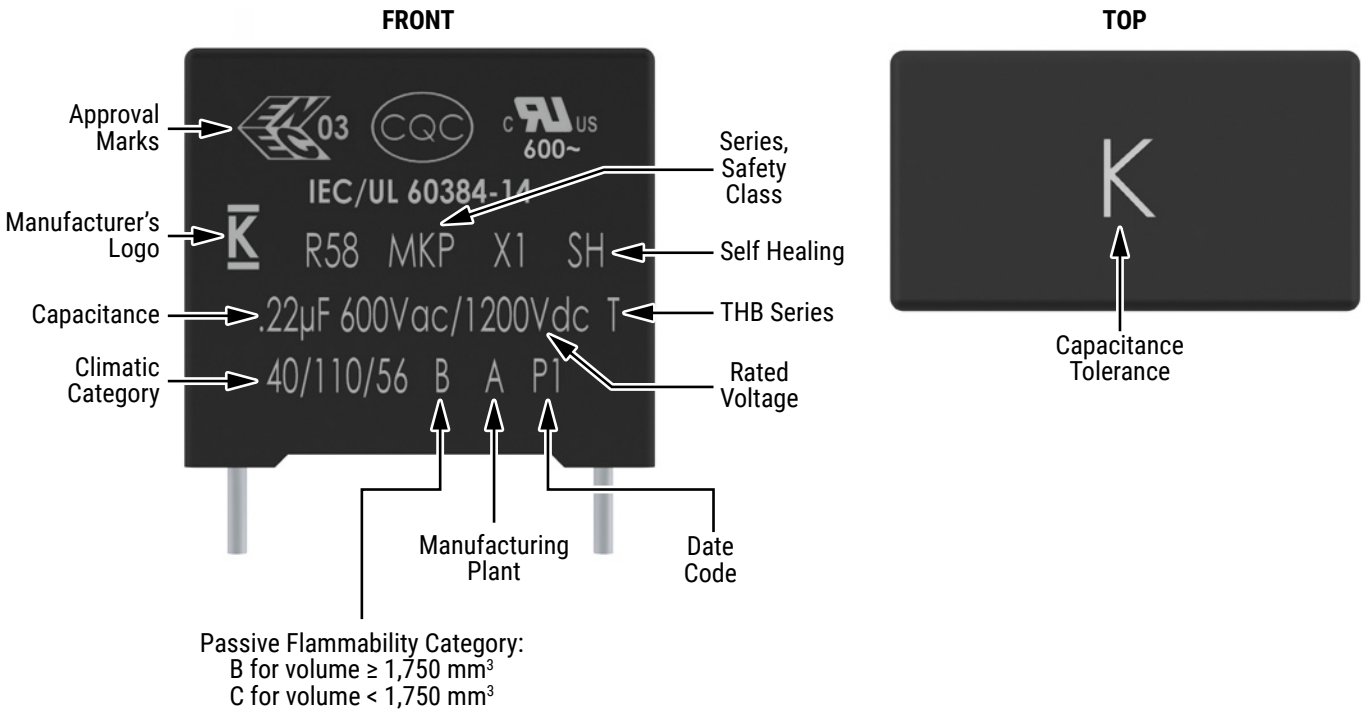

Slight change in the layout can be possible but this does not affect the content of the information of the current marking. This change will be achieved without impact to product form, fit or function, as the products are equivalent with respect to physical, mechanical, quality and reliability characteristics

Marking cont.

Lead Spacing 27.5 mm alternative*, 37.5 mm and 52.5 mm in rectangular box

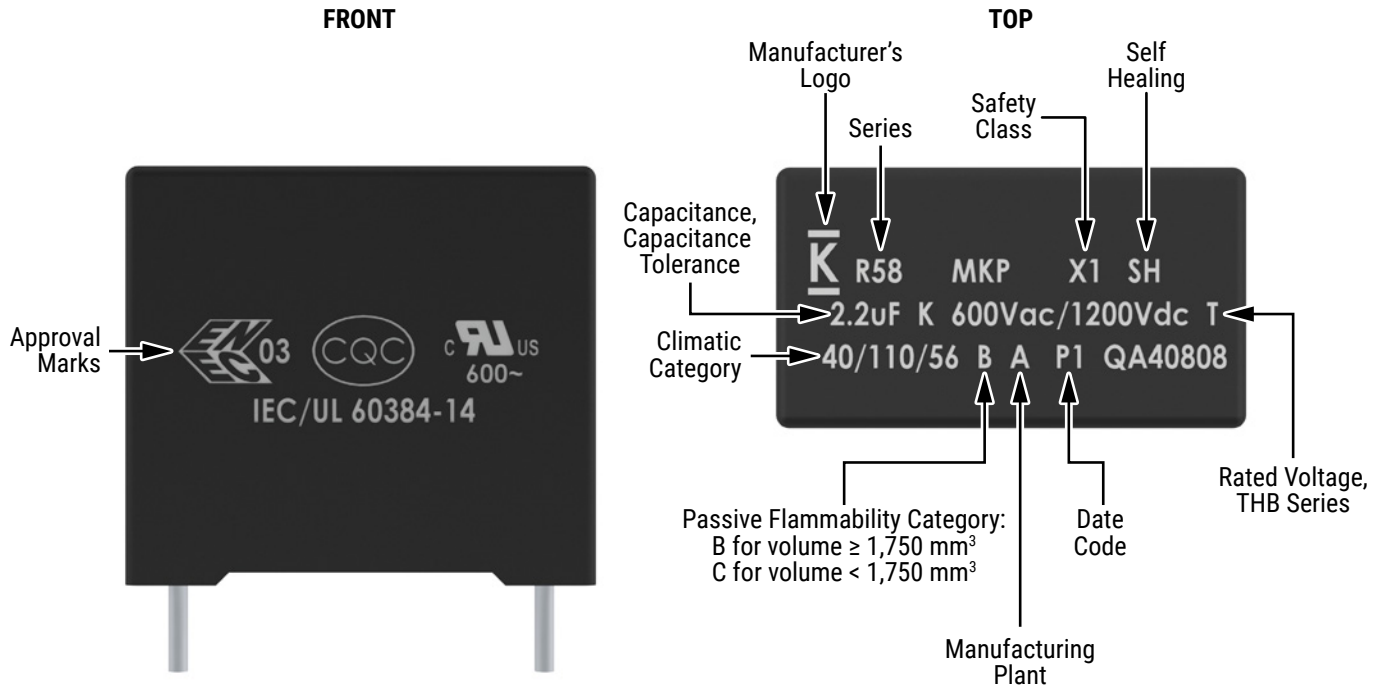

* Differences caused by technology (clichee, laser or ink jet) and production line

Slight change in the layout can be possible but this does not affect the content of the information of the current marking.

This change will be achieved without impact to product form, fit or function, as the products are equivalent with respect to physical, mechanical, quality and reliability characteristics

Marking cont.

Lead Spacing 52.5 mm in Arc Shaped Design Case

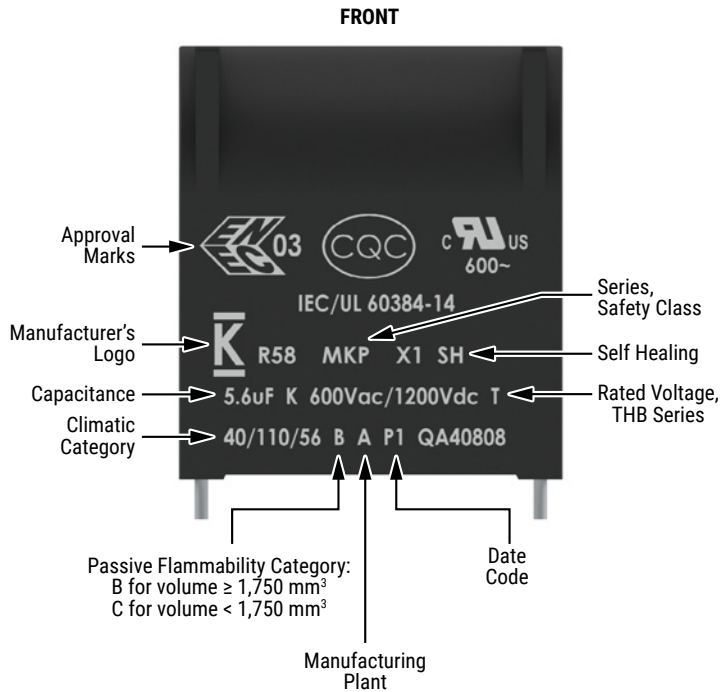

* Differences caused by technology (clichee, laser or ink jet) and production line

Slight change in the layout can be possible but this does not affect the content of the information of the current marking.

This change will be achieved without impact to product form, fit or function, as the products are equivalent with respect to physical, mechanical, quality and reliability characteristics

Manufacturing Date Code (IEC 60062)									
Year	Code	Year	Code	Year	Code	Month	Code	Month	Code
2020	M	2027	V	2034	E	January	1	July	7
2021	N	2028	W	2035	F	February	2	August	8
2022	P	2029	X	2036	H	March	3	September	9
2023	R	2030	A	2037	J	April	4	October	0
2024	S	2031	B	2038	K	May	5	November	N
2025	T	2032	C	2039	L	June	6	December	D
2026	U	2033	D	2040	M				

Packaging Quantities

Lead Spacing	Thickness (mm)	Height (mm)	Length (mm)	Bulk Short Leads	Bulk Long Leads		Standard Reel ø 355 mm	Large Reel ø 500 mm	Ammo Taped	Pizza
Lead And Packaging Code:				00 - JA - JB JE - JH	JM	40 - 50	GY	CK	DQ	BB
15	5	11	18	2,000	1,250	1,000	600	1,250	800	1,122
	6	12	18	1,750	1,000	900	500	1,000	680	935
	7.5	13.5	18	1,000	800	700	350	800	500	748
	8.5	14.5	18	1,000	650	500	300	700	440	663
	10	16	18	750	550	500	270	600	380	561
	11	19	18	450	400	350	-	500	340	510
22.5	6	15	26.5	805	450	500	-	700	464	660
	7	16	26.5	700	450	500	-	550	380	564
	8.5	17	26.5	468	350	300	-	450	280	468
	10	18.5	26.5	396	350	300	-	350	235	396
	11	20	26.5	360	200	250	-	350	217	360
	13	22	26.5	300	150	200	-	300	-	300
27.5	11	20	32	560	336	336	-	350	-	300
	13	22	32	480	288	288	-	300	-	250
	14	28	32	352	176	176	-	-	-	230
	18	33	32	256	128	128	-	-	-	170
	22	37	32	168	112	112	-	-	-	150
37.5	11	22	42	204	102	102	-	-	-	-
	13	24	42	168	84	84	-	-	-	-
	16	28.5	42	66	66	66	-	-	-	-
	19	32	42	58	58	58	-	-	-	-
	20	40	42	58	58	58	-	-	-	-
	24	44	42	44	44	44	-	-	-	-
	30	45	42	36	36	36	-	-	-	-
52.5	30	45	57.5	27	-	-	-	-	-	-
	35	50	57.5	23	-	-	-	-	-	-
	45	56	57.5	18	-	-	-	-	-	-

Lead Taping & Packaging (IEC 60286-2)

Figure 1 – Lead Spacing 15 mm

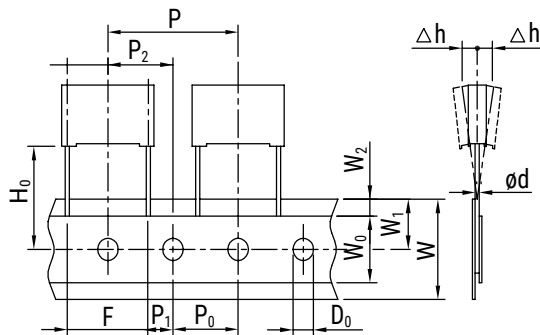
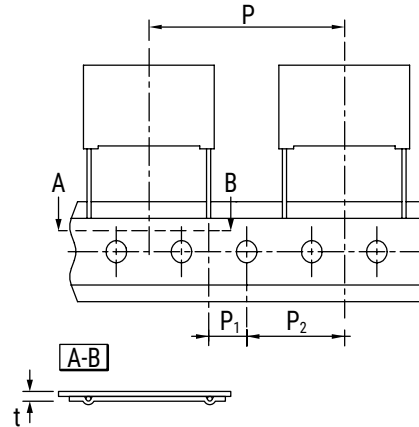

Figure 2 – Lead Spacing 22.5 & 27.5 mm



Taping Specification

Description	Symbol	Dimensions (mm)				Tol.
		Lead Space				
		15 Fig. 2	22.5 Fig. 3	27.5 Fig. 3		
Lead Wire Diameter	d	0.6-0.8	0.8	0.8	±0.05	
Taping Lead Space	P	25.4	38.1	38.1	±1	
Feed Hole Lead Space *	P ₀	12.7	12.7	12.7	±0.2 **	
Centering of the Lead Wire	P ₁	5.2	7.8	5.3	±0.7	
Centering of the Body	P ₂	12.7	19.05	19.05	±1.3	
Lead Spacing (Pitch) ***	F	15	22.5	27.5	+0.6/-0.1	
Component Alignment	Δh	0	0	0	±2	
Height of Component from Tape Center	H ₀ ****	18.5	18.5	18.5	±0.5	
Carrier Tape Width	W	18	18	18	+1/-0.5	
Hold Down Tape Width	W ₀	10	10	10	Minimum	
Hole Position	W ₁	10	10	10	±0.5	
Hold Down Tape Position	W ₂	3	3	3	Maximum	
Feed Hole Diameter	D ₀	4	4	4	±0.2	
Total Tape Thickness	t	0.7	0.7	0.7	±0.2	

* 15 mm also available

** Maximum of 1 mm on 20 lead spaces

*** Pitches 15 mm and 10 mm taped to 7.5 mm (crimped leads) available upon request

**** H₀ = 16.5 mm is available upon request

Lead Taping & Packaging (IEC 60286-2) cont.

Ammo Specifications

Dimensions (mm)		
H	W	T
360	340	59

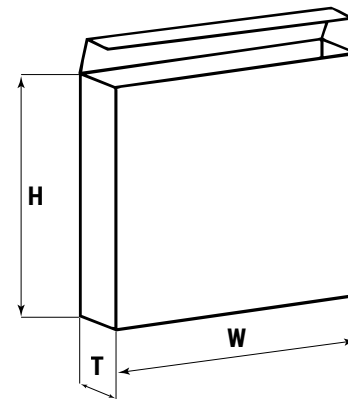

Reel Specifications

Reel Size	Dimensions (mm)		
	D	H	W
Standard	355	30	55 Maximum
Large	500	25	

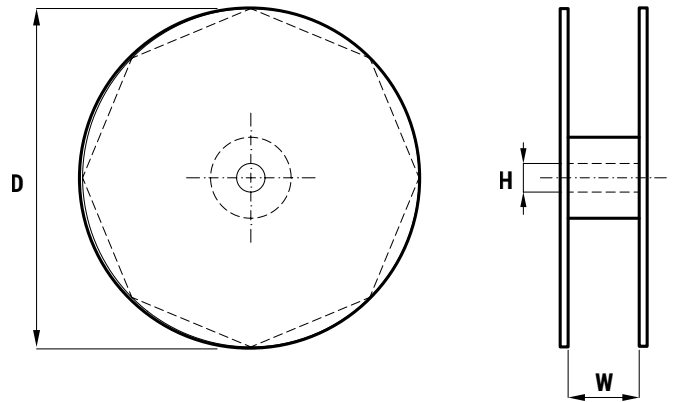

KEMET Electronics Corporation Sales Offices

For a complete list of our global sales offices, please visit www.kemet.com/sales.

Disclaimer

YAGEO Corporation and its affiliates do not recommend the use of commercial or automotive grade products for high reliability applications or manned space flight.

All product specifications, statements, information and data (collectively, the "Information") in this datasheet are subject to change. The customer is responsible for checking and verifying the extent to which the Information contained in this publication is applicable to an order at the time the order is placed. All Information given herein is believed to be accurate and reliable, but it is presented without guarantee, warranty, or responsibility of any kind, expressed or implied.

Statements of suitability for certain applications are based on KEMET Electronics Corporation's ("KEMET") knowledge of typical operating conditions for such applications, but are not intended to constitute – and KEMET specifically disclaims – any warranty concerning suitability for a specific customer application or use. The Information is intended for use only by customers who have the requisite experience and capability to determine the correct products for their application. Any technical advice inferred from this Information or otherwise provided by KEMET with reference to the use of KEMET's products is given gratis, and KEMET assumes no obligation or liability for the advice given or results obtained.

Although KEMET designs and manufactures its products to the most stringent quality and safety standards, given the current state of the art, isolated component failures may still occur. Accordingly, customer applications which require a high degree of reliability or safety should employ suitable designs or other safeguards (such as installation of protective circuitry or redundancies) in order to ensure that the failure of an electrical component does not result in a risk of personal injury or property damage.

Although all product-related warnings, cautions and notes must be observed, the customer should not assume that all safety measures are indicated or that other measures may not be required.

Additional information about production site flexibility can be found [here](#)

KEMET is a registered trademark of KEMET Electronics Corporation.