



Features

- Standard Zener Breakdown Voltage Range – 2.0 V to 75 V
- Steady State Power Rating of 200 mW
- Small Body Outline Dimensions: 0.047" x 0.032"(1.20 mm x 0.80 mm)
- Low Body Height: 0.028" (0.7 mm)
- ESD Rating of Class 3 (>16 kV) per Human Body Model



SOD-523
(SOD-523F)



Package Marking and Ordering Information

Product ID	Pack	Marking	Qty(PCS)
MM5ZXX	SOD-523 (SOD-523F)	XX	3000

XX=Device code, see table on page2 the marking code.
The marking bar indicates the cathode.

Absolute Maximum Ratings(Ta=25°C)

Rating	Symbol	Max	Unit
Total Device Dissipation FR-5 Board, @ T _A = 25°C	P _D	200	mW
Junction and Storage Temperature Range	T _J , T _{stg}	-65 to +150	°C

Electrical Characteristics

(T_A = 25°C unless otherwise noted,
V_F = 0.9 V Max. @ I_F = 10 mA for all types)

Symbol	Parameter
V _Z	Reverse Zener Voltage @ I _{ZT}
I _{ZT}	Reverse Current
Z _{ZT}	Maximum Zener Impedance @ I _{ZT}
I _{ZK}	Reverse Current
Z _{ZK}	Maximum Zener Impedance @ I _{ZK}
I _R	Reverse Leakage Current @ V _R
V _R	Reverse Voltage
I _F	Forward Current
V _F	Forward Voltage @ I _F
θV _Z	Maximum Temperature Coefficient of V _Z
C	Max. Capacitance @ V _R = 0 and f = 1 MHz

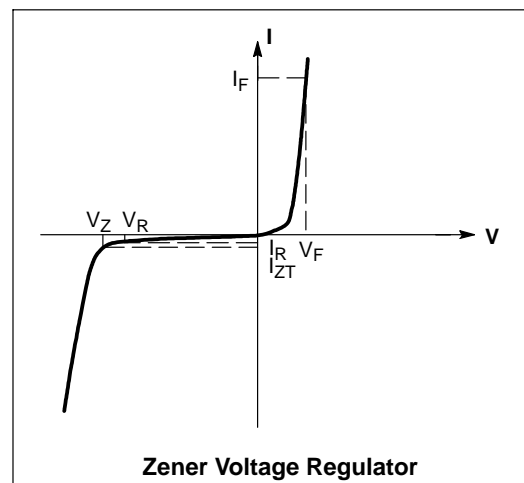



Electrical Characteristics ($T_A = 25^\circ\text{C}$ unless otherwise noted, $V_F = 0.9\text{ V}$ Max. @ $I_F = 10\text{ mA}$ for all types)

Device	Device Marking	Zener Voltage (Note 1)				Zener Impedance			Leakage Current		θ_{VZ} (mV/k) @ I_{ZT}		C @ $V_R = 0$ f = 1 MHz
		V_Z (Volts)			@ I_{ZT}	Z_{ZT} @ I_{ZT}	Z_{ZK} @ I_{ZK}		I_R @ V_R		Min	Max	
		Min	Nom	Max	mA	Ω	Ω	mA	μA	Volts	Min	Max	pF
MM5Z2V0	WY	1.91	2.0	2.09	5	100	600	1.0	150	1.0	-3.5	0	450
MM5Z2V4	00	2.2	2.4	2.6	5	100	1000	1.0	50	1.0	-3.5	0	450
MM5Z2V7	01	2.5	2.7	2.9	5	100	1000	1.0	20	1.0	-3.5	0	450
MM5Z3V0	02	2.8	3.0	3.2	5	100	1000	1.0	10	1.0	-3.5	0	450
MM5Z3V3	05	3.1	3.3	3.5	5	95	1000	1.0	5	1.0	-3.5	0	450
MM5Z3V6	06	3.4	3.6	3.8	5	90	1000	1.0	5	1.0	-3.5	0	450
MM5Z3V9	07	3.7	3.9	4.1	5	90	1000	1.0	3	1.0	-3.5	-2.5	450
MM5Z4V3	08	4.0	4.3	4.6	5	90	1000	1.0	3	1.0	-3.5	0	450
MM5Z4V7	09	4.4	4.7	5.0	5	80	800	1.0	3	2.0	-3.5	0.2	260
MM5Z5V1	0A	4.8	5.1	5.4	5	60	500	1.0	2	2.0	-2.7	1.2	225
MM5Z5V6	W9	5.2	5.6	6.0	5	40	400	1.0	1	2.0	-2.0	2.5	200
MM5Z6V2	0E	5.8	6.2	6.6	5	10	100	1.0	3	4.0	0.4	3.7	185
MM5Z6V8	0F	6.4	6.8	7.2	5	15	160	1.0	2	4.0	1.2	4.5	155
MM5Z7V5	0G	7.0	7.5	7.9	5	15	160	1.0	1	5.0	2.5	5.3	140
MM5Z8V2	0H	7.7	8.2	8.7	5	15	160	1.0	0.7	5.0	3.2	6.2	135
MM5Z9V1	0K	8.5	9.1	9.6	5	15	160	1.0	0.2	7.0	3.8	7.0	130
MM5Z10V	0L	9.4	10	10.6	5	20	160	1.0	0.1	8.0	4.5	8.0	130
MM5Z11V	0M	10.4	11	11.6	5	20	160	1.0	0.1	8.0	5.4	9.0	130
MM5Z12V	0N	11.4	12	12.7	5	25	80	1.0	0.1	8.0	6.0	10	130
MM5Z13V	0P	12.4	13.25	14.1	5	30	80	1.0	0.1	8.0	7.0	11	120
MM5Z15V	0T	14.3	15	15.8	5	30	200	1.0	0.05	10.5	9.2	13	110
MM5Z16V	0U	15.3	16.2	17.1	2	40	200	1.0	0.05	11.2	10.4	14	105
MM5Z18V	0W	16.8	18	19.1	2	45	225	1.0	0.05	12.6	12.4	16	100
MM5Z20V	0Z	18.8	20	21.2	2	55	225	1.0	0.05	14.0	14.4	18	85
MM5Z22V	10	20.8	22	23.3	2	55	250	1.0	0.05	15.4	16.4	20	85
MM5Z24V	11	22.8	24.2	25.6	2	70	120	1.0	0.05	16.8	18.4	22	80
MM5Z27V	12	25.1	27	28.9	2	80	300	1.0	0.05	18.9	21.4	25.3	70
MM5Z30V	14	28	30	32	2	80	300	1.0	0.05	21.0	24.4	29.4	70
MM5Z33V	18	31	33	35	2	80	300	1.0	0.05	23.2	27.4	33.4	70
MM5Z36V	19	34	36	38	2	90	500	1.0	0.05	25.2	30.4	37.4	70
MM5Z39V	20	37	39	41	2	130	500	1.0	0.05	27.3	33.4	41.2	45

1. Zener voltage is measured with a pulse test current I_Z at an ambient temperature of 25°C .



Typical Characteristics

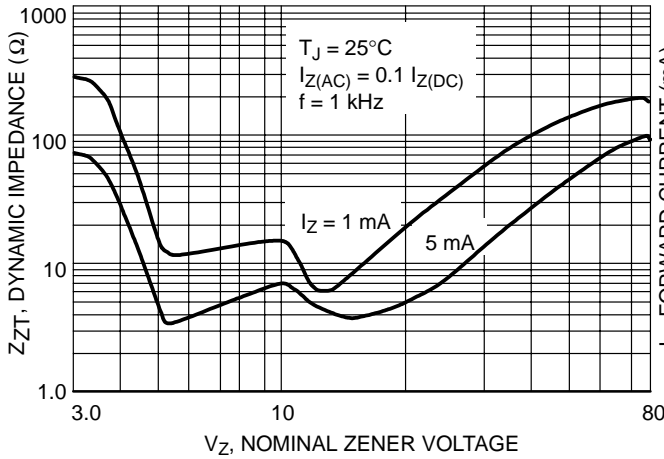

Figure 1. Effect of Zener Voltage on Zener Impedance

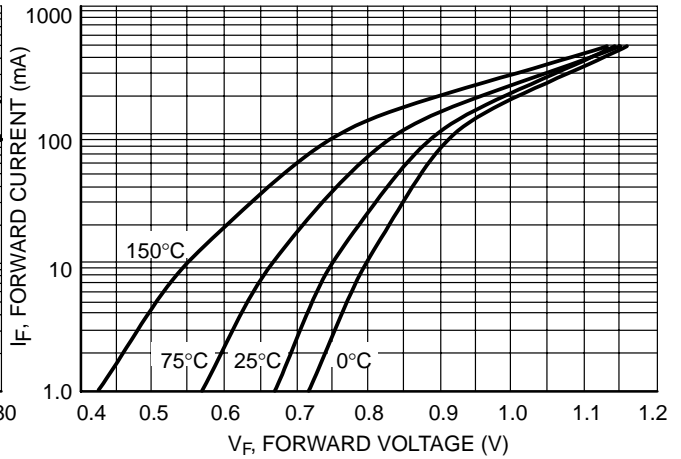

Figure 2. Typical Forward Voltage

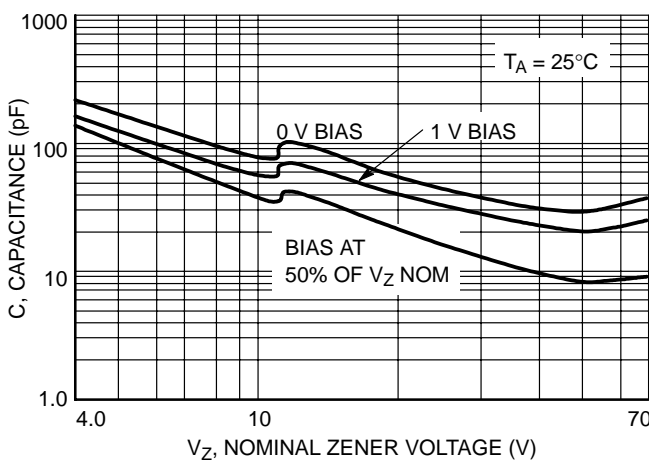

Figure 3. Typical Capacitance

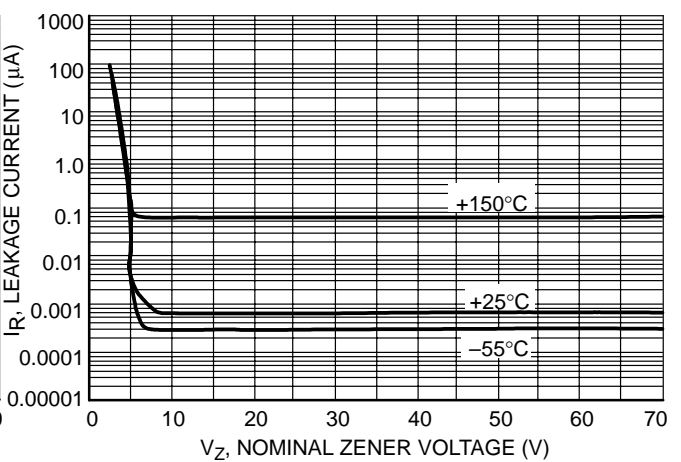

Figure 4. Typical Leakage Current



Typical Characteristics

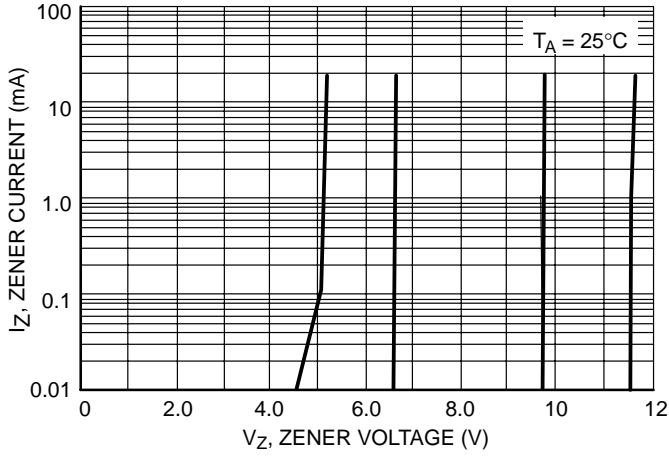

Figure 5. Zener Voltage versus Zener Current
(V_Z Up to 12 V)

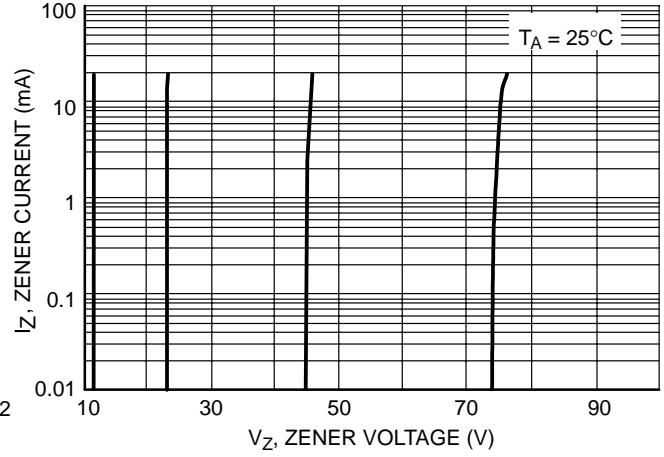

Figure 6. Zener Voltage versus Zener Current
(12 V to 75 V)

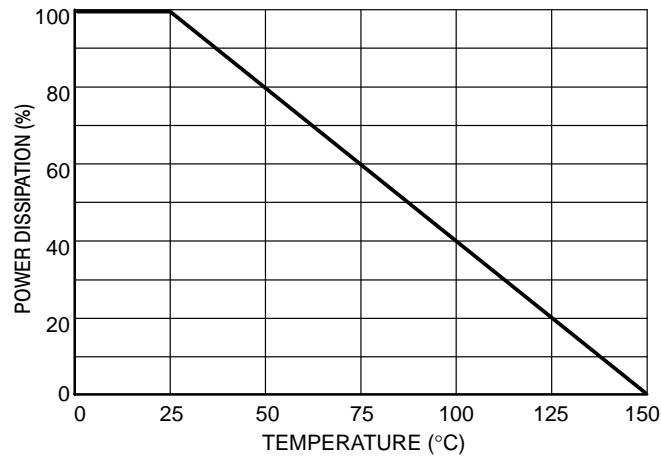
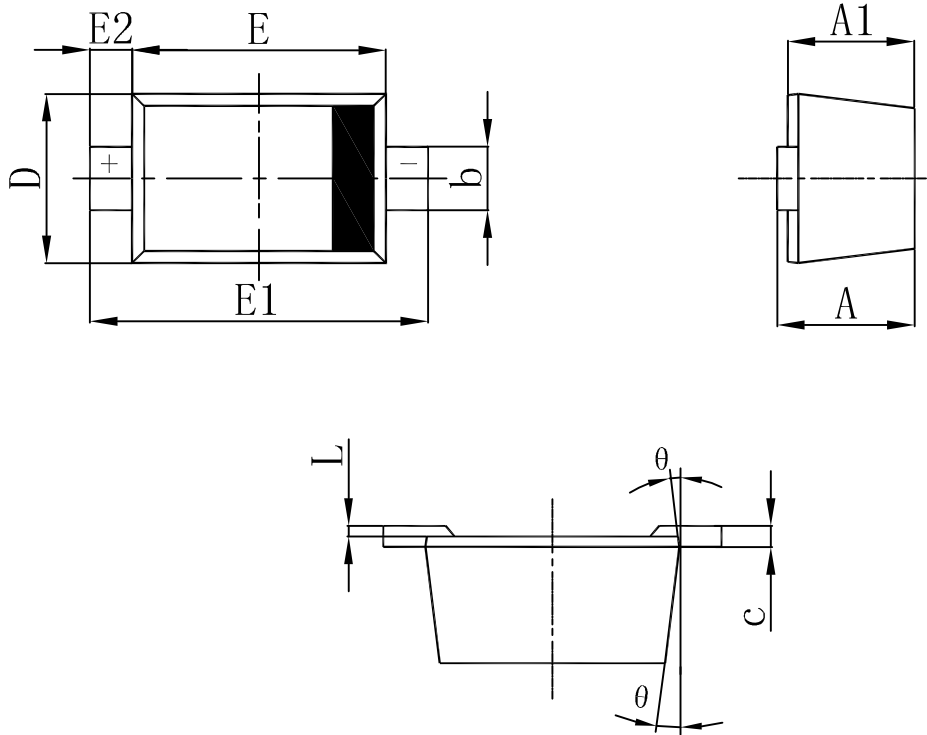

Figure 7. Steady State Power Derating



SOD-523(SOD-523F) Package Outline Dimensions



Symbol	Dimensions In Millimeters		Dimensions In Inches	
	Min	Max	Min	Max
A	0.510	0.770	0.020	0.031
A1	0.500	0.700	0.020	0.028
b	0.250	0.350	0.010	0.014
c	0.080	0.150	0.003	0.006
D	0.750	0.850	0.030	0.033
E	1.100	1.300	0.043	0.051
E1	1.500	1.700	0.059	0.067
E2	0.200 REF		0.008 REF	
L	0.010	0.070	0.001	0.003
θ	7° REF		7° REF	



Attention

- Any and all HUA XUAN YANG ELECTRONICS products described or contained herein do not have specifications that can handle applications that require extremely high levels of reliability, such as life-support systems, aircraft's control systems, or other applications whose failure can be reasonably expected to result in serious physical and/or material damage. Consult with your HUA XUAN YANG ELECTRONICS representative nearest you before using any HUA XUAN YANG ELECTRONICS products described or contained herein in such applications.
- HUA XUAN YANG ELECTRONICS assumes no responsibility for equipment failures that result from using products at values that exceed, even momentarily, rated values (such as maximum ratings, operating condition ranges, or other parameters) listed in products specifications of any and all HUA XUAN YANG ELECTRONICS products described or contained herein.
- Specifications of any and all HUA XUAN YANG ELECTRONICS products described or contained herein stipulate the performance, characteristics, and functions of the described products in the independent state, and are not guarantees of the performance, characteristics, and functions of the described products as mounted in the customer's products or equipment. To verify symptoms and states that cannot be evaluated in an independent device, the customer should always evaluate and test devices mounted in the customer's products or equipment.
- HUA XUAN YANG ELECTRONICS CO.,LTD. strives to supply high-quality high-reliability products. However, any and all semiconductor products fail with some probability. It is possible that these probabilistic failures could give rise to accidents or events that could endanger human lives, that could give rise to smoke or fire, or that could cause damage to other property. When designing equipment, adopt safety measures so that these kinds of accidents or events cannot occur. Such measures include but are not limited to protective circuits and error prevention circuits for safe design, redundant design, and structural design.
- In the event that any or all HUA XUAN YANG ELECTRONICS products(including technical data, services) described or contained herein are controlled under any of applicable local export control laws and regulations, such products must not be exported without obtaining the export license from the authorities concerned in accordance with the above law.
- No part of this publication may be reproduced or transmitted in any form or by any means, electronic or mechanical, including photocopying and recording, or any information storage or retrieval system, or otherwise, without the prior written permission of HUA XUAN YANG ELECTRONICS CO.,LTD.
- Information (including circuit diagrams and circuit parameters) herein is for example only ; it is not guaranteed for volume production. HUA XUAN YANG ELECTRONICS believes information herein is accurate and reliable, but no guarantees are made or implied regarding its use or any infringements of intellectual property rights or other rights of third parties.
- Any and all information described or contained herein are subject to change without notice due to product/technology improvement, etc. When designing equipment, refer to the "Delivery Specification" for the HUA XUAN YANG ELECTRONICS product that you intend to use.