

# SZ5KASMC Series

## Automotive, Surface Mount 5000 W in DO-214AB



### Web Resources



Download ECAD models, order samples, and find technical resources at [www.littelfuse.com/SZ5KASMC](http://www.littelfuse.com/SZ5KASMC)

### Agency Approvals

Agency	Agency File Number
	E128662

### Maximum Ratings & Thermal Characteristics

Parameter	Symbol	Value	Unit
Peak Power Dissipation (Note 1) @ $T_L = 25$ °C, Pulse Width = 1 ms	$P_{PPM}$	5000	W
DC Power Dissipation @ $T_L = 75$ °C Measured Zero Lead Length (Note 2) Derate Above 75 °C	$P_D$	5.4 54.6	W mW/°C
DC Power Dissipation (Note 3) @ $T_A = 25$ °C Derate Above 25 °C	$P_D$	2.0 13.3	W mW/°C
Forward Surge Current (Note 4) @ $T_A = 25$ °C (For Uni-directional)	$I_{FSM}$	300	A
Operating and Storage Temperature Range	$T_J$ $T_{stg}$	-65 to +175	°C
Thermal Resistance from Junction-to-Ambient	$R_{\theta JA}$	75	°C/W
Thermal Resistance from Junction-to-Lead	$R_{\theta JL}$	18.3	°C/W

Stresses exceeding maximum ratings may damage the device. Maximum ratings are stress ratings only. Functional operation above the recommended operating conditions is not implied. Extended exposure to stresses above the recommended operating conditions may affect device reliability.

#### Notes:

- 10 x 1000  $\mu$ s, non-repetitive.
- 1-inch square copper pad, FR-4 board.
- FR-4 board, using Littelfuse minimum recommended footprint
- 1/2 sine wave (or equivalent square wave), PW = 8.3 ms, duty cycle = 4 pulses per minute maximum

### Description

The SZ5KASMC Series protects voltage-sensitive components from high-voltage, high-energy transients. It has excellent clamping capability, high surge capability, low Zener impedance, and fast response time. The SZ5KASMC series is supplied in a cost-effective, highly reliable DO-214AB package, ideal for use in automotive electronic applications.

### Features and Benefits

- Automotive grade, AEC-Q101 qualified and PPAP-capable
- Peak power – 5000 W@1 ms
- Working peak reverse voltage range - 5.0 V to 48 V for unidirectional and 10 V to 36 V for bidirectional
- Standard zener breakdown voltage range - 11.1 V to 44.2 V
- Compact design in DO-214AB package
- ESD protection of data lines in accordance with IEC 61000-4-2 30 kV (Air), 30 kV (Contact)
- ESD rating of class 3 (>16 kV) per human body model
- Zener transient overvoltage suppressors
- Excellent clamping capability
- UL recognized compound meeting flammability rating V-0
- $V_{BR} @ T_J = V_{BR} @ 25^\circ C \times (1 + \alpha T \times (T_J - 25))$  ( $\alpha T$ : Temperature coefficient, typical value is 0.1%)
- Maximum temperature coefficient specified
- Response time is typically < 1 ns
- These components are Pb-free and are ROHS-compliant
- UL-recognized as an isolated loop circuit protector to UL 497B

### Applications

TVS devices are ideal for the protection of I/O Interfaces,  $V_{CC}$  bus and other vulnerable circuits used in automotive applications.

#### Functional Diagram

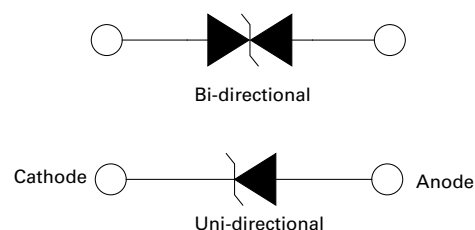

# SZ5KASMC Series

## Automotive, Surface Mount 5000 W in DO-214AB

### Electrical Characteristics

Part Number (Uni)	Part Number (Bi)	Marking		Working Peak Reverse Voltage $V_{RWM}$ (Note 5) (V)	Breakdown Voltage $V_{BR}$ (V) @ $I_T$ (Note 6)		Test Current $I_T$ (mA)	Maximum Clamping Voltage $V_C$ @ $I_{PP}$ (Note 7) (V)	Maximum Peak Pulse Current $I_{PP}$ (A)	Maximum Reverse Leakage $I_R$ @ $V_R$ ( $\mu$ A)	Agency Approval 
		Uni	Bi		Min	Max					
SZ5KASMC5.0AT3G	-	5PAA	-	5.0	6.40	7.00	10	9.2	543.5	1000	x
SZ5KASMC6.0AT3G	-	5PAB	-	6.0	6.67	7.37	10	10.3	485.4	1000	x
SZ5KASMC6.5AT3G	-	5PAE	-	6.5	7.22	7.98	10	11.2	446.4	500	x
SZ5KASMC7.0AT3G	-	5PAF	-	7.0	7.80	8.60	10	12.0	416.7	500	x
SZ5KASMC7.5AT3G	-	5PAG	-	7.5	8.33	9.21	10	12.9	387.6	100	x
SZ5KASMC8.0AT3G	-	5PAK	-	8.0	8.89	9.83	1	13.6	367.6	100	x
SZ5KASMC8.5AT3G	-	5PAM	-	8.5	9.40	10.4	1	14.4	347.2	50	x
SZ5KASMC9.0AT3G	-	5PAN	-	9.0	10.0	11.1	1	15.4	324.7	50	x
SZ5KASMC10AT3G	SZ5KASMC10CAT3G	5PAR	5BAR	10.0	11.1	12.3	1	17.0	294.1	20	x
SZ5KASMC11AT3G	SZ5KASMC11CAT3G	5PAT	5BAT	11.0	12.2	13.5	1	18.2	274.7	20	x
SZ5KASMC12AT3G	SZ5KASMC12CAT3G	5PEP	5BEP	12.0	13.3	14.7	1	19.9	251.3	10	x
SZ5KASMC13AT3G	SZ5KASMC13CAT3G	5PEQ	5BEQ	13.0	14.4	15.9	1	21.5	232.6	10	x
SZ5KASMC14AT3G	SZ5KASMC14CAT3G	5PER	5BER	14.0	15.6	17.2	1	23.2	215.5	5	x
SZ5KASMC15AT3G	SZ5KASMC15CAT3G	5PES	5BES	15.0	16.7	18.5	1	24.4	204.9	5	x
SZ5KASMC16AT3G	SZ5KASMC16CAT3G	5PET	5BET	16.0	17.8	19.7	1	26.0	192.3	5	x
SZ5KASMC17AT3G	SZ5KASMC17CAT3G	5PEU	5BEU	17.0	18.9	20.9	1	27.6	181.2	5	x
SZ5KASMC18AT3G	SZ5KASMC18CAT3G	5PEV	5BEV	18.0	20.0	22.1	1	29.2	171.2	5	x
SZ5KASMC20AT3G	SZ5KASMC20CAT3G	5PEW	5BEW	20.0	22.2	24.5	1	32.4	154.3	5	x
SZ5KASMC22AT3G	SZ5KASMC22CAT3G	5PEX	5BEX	22.0	24.4	26.9	1	35.5	140.8	5	x
SZ5KASMC24AT3G	SZ5KASMC24CAT3G	5PEY	5BEY	24.0	26.7	29.5	1	38.9	128.5	5	x
SZ5KASMC26AT3G	SZ5KASMC26CAT3G	5PEF	5BEZ	26.0	28.9	31.9	1	42.1	118.2	5	x
SZ5KASMC28AT3G	SZ5KASMC28CAT3G	5PBG	5BFG	28.0	31.1	34.4	1	45.4	110.5	5	x
SZ5KASMC30AT3G	SZ5KASMC30CAT3G	5PFM	5BFM	30.0	33.3	36.8	1	48.4	103.3	5	x
SZ5KASMC33AT3G	SZ5KASMC33CAT3G	5PFN	5BFN	33.0	36.7	40.6	1	53.3	93.8	5	x
SZ5KASMC36AT3G	SZ5KASMC36CAT3G	5PFO	5BFO	36.0	40.0	44.1	1	58.1	86.1	5	x
SZ5KASMC40AT3G	-	5PFP	-	40.0	44.4	49.1	1	64.5	77.5	5	x
SZ5KASMC43AT3G	-	5PFT	-	43.0	47.8	52.8	1	69.4	72.0	5	x
SZ5KASMC45AT3G	-	5PFV	-	45.0	50.0	55.3	1	72.2	69.4	5	x
SZ5KASMC48AT3G	-	5PFX	-	48.0	53.3	58.9	1	77.4	64.6	5	x

5. A transient suppressor is normally selected according to the maximum working peak reverse voltage ( $V_{RWM}$ ), which should be equal to or greater than the DC or continuous peak operating voltage level.

6.  $V_{BR}$  measured at pulse test current  $I_T$  at an ambient temperature of 25 °C.

7. Surge current waveform per figure 2 and de-rate per figure 4 of the general data – 5000 watt at the beginning of this group.

### I-V Curve Characteristics (TA = 25 °C unless otherwise noted, VF = 3.5 V Max. @ IF = 100 A)\* For Unidirectional

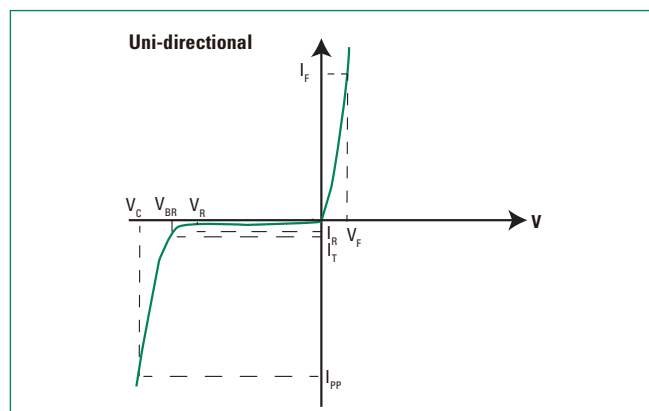

Symbol	Parameter
$I_{PP}$	Maximum Reverse Peak Pulse Current
$V_C$	Clamping Voltage @ $I_{PP}$
$V_{RWM}$	Working Peak Reverse Voltage
$I_R$	Maximum Reverse Leakage Current @ $V_{RWM}$
$V_{BR}$	Breakdown Voltage @ $I_T$
$I_T$	Breakdown Current Current

Note: \*1/2 sine wave (or equivalent square wave), PW = 8.3 ms, non-repetitive duty cycle.

# SZ5KASMC Series

Automotive, Surface Mount 5000 W in DO-214AB

I-V Curve Characteristics (TA = 25 °C unless otherwise noted) For Bidirectional

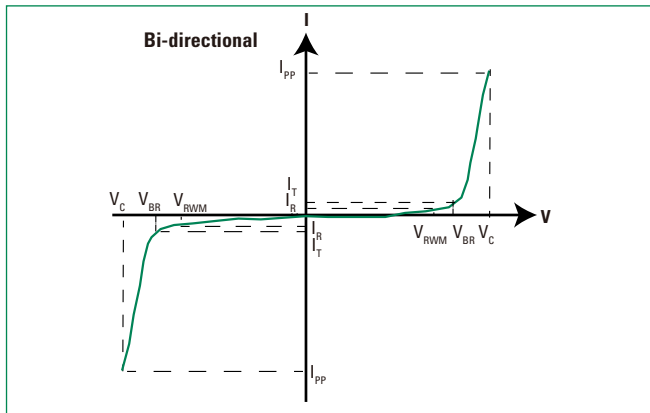

Symbol	Parameter
$I_{PP}$	Maximum Reverse Peak Pulse Current
$V_C$	Clamping Voltage @ $I_{PP}$
$V_{RWM}$	Working Peak Reverse Voltage
$I_R$	Maximum Reverse Leakage Current @ $V_{RWM}$
$V_{BR}$	Breakdown Voltage @ $I_T$
$I_T$	Breakdown Current Current

Figure 1. Pulse Rating Curve

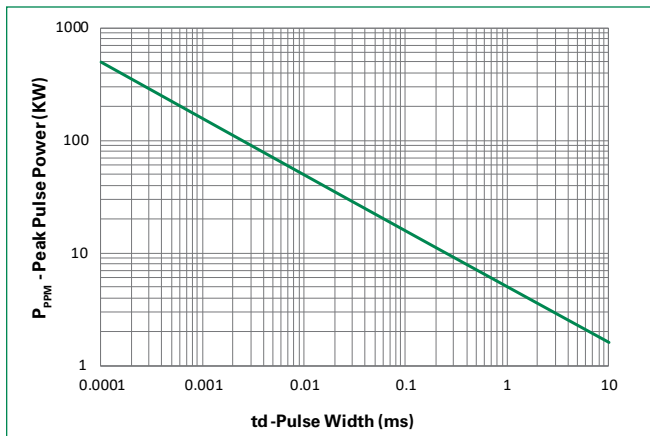

Figure 2. 10/1000 µs Pulse Waveform

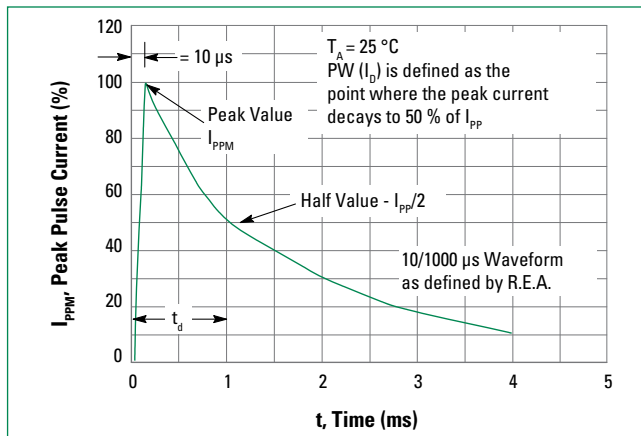

Figure 3. Typical Junction Capacitance vs. Bias Voltage

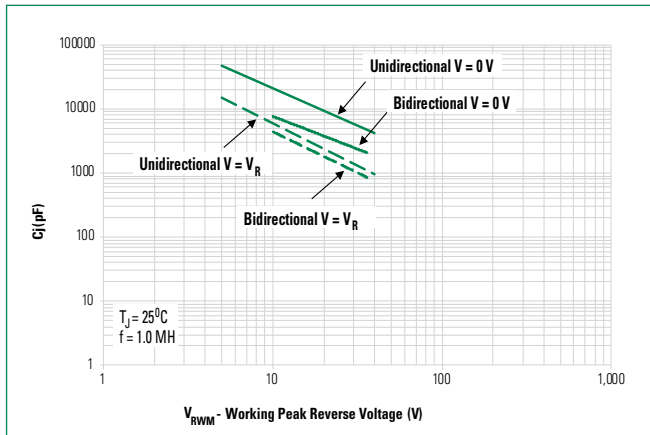
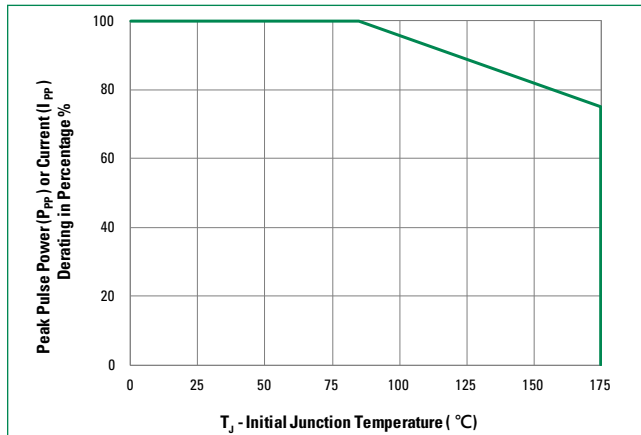

Figure 4. Surge Derating Curve



# SZ5KASMC Series

## Automotive, Surface Mount 5000 W in DO-214AB

### Soldering Parameters

<b>Reflow Condition</b>		Lead-free assembly
<b>Pre Heat</b>	- Temperature Min ( $T_{s(min)}$ )	150 °C
	- Temperature Max ( $T_{s(max)}$ )	200 °C
	- Time (min to max) ( $t_s$ )	60 – 120 seconds
<b>Average Ramp Up Rate (Liquidus Temp (<math>T_L</math>) to Peak</b>		3 °C/second max
<b><math>T_{s(max)}</math> to <math>T_L</math> - Ramp-up Rate</b>		3 °C/second max
<b>Reflow</b>	- Temperature ( $T_L$ ) (Liquidus)	217 °C
	- Time (min to max) ( $t_s$ )	60 – 150 seconds
<b>Peak Temperature (<math>T_p</math>)</b>		260 <sup>+0/-5</sup> °C
<b>Time within 5 °C of Actual Peak Temperature (<math>t_p</math>)</b>		30 seconds max
<b>Ramp-down Rate</b>		6 °C/second max
<b>Time 25 °C to Peak Temperature (<math>T_p</math>)</b>		8 minutes max.
<b>Do Not Exceed</b>		260 °C

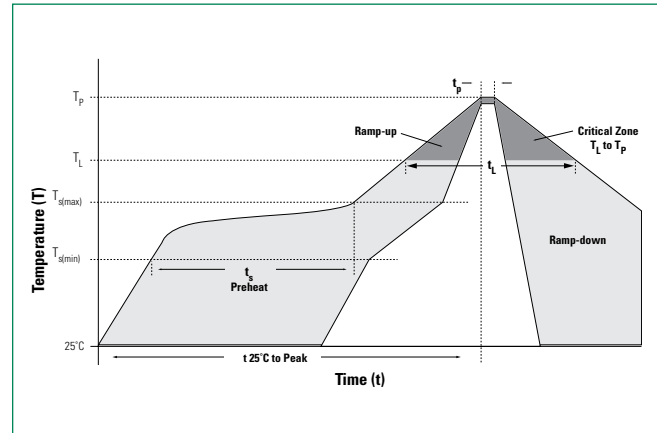

### Physical Specifications

<b>Weight</b>	0.00733 ounce, 0.228 grams
<b>Case</b>	JEDEC DO-214AB. Void-free, transfer-molded, thermosetting plastic epoxy meets UL 94V-0
<b>Polarity</b>	Color band denotes cathode except bidirectional
<b>Terminal</b>	Matte Tin-plated leads, solderable per JESD22-B102

### Environmental Specifications

<b>High Temperature Storage</b>	JESD22-A103
<b>HTRB</b>	JESD22-A108
<b>Temperature Cycling</b>	JESD22-A104
<b>MSL</b>	JEDEC J-STD-020, Level 1
<b>H3TRB</b>	JESD22-A101
<b>RSH</b>	JESD22-A111

### Dimensions

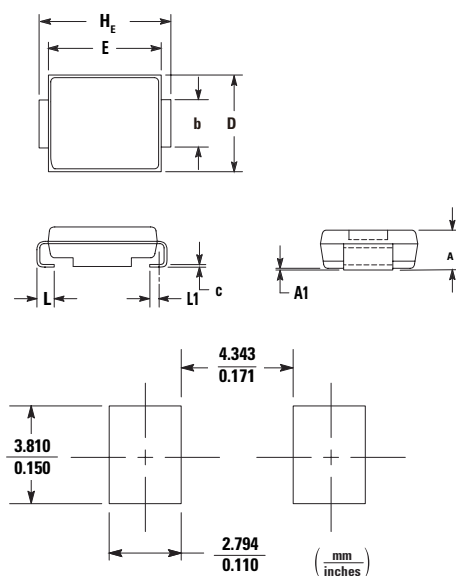

Soldering Footprint

Dim	Inches			Millimeters		
	Min	Nom	Max	Min	Nom	Max
A	0.079	0.087	0.095	2.00	2.22	2.41
A1	0.002	0.004	0.008	0.05	0.10	0.20
b	0.115	0.118	0.125	2.92	3.00	3.18
c	0.006	0.009	0.012	0.15	0.23	0.30
D	0.220	0.230	0.240	5.59	5.84	6.10
E	0.260	0.270	0.280	6.60	6.86	7.11
H <sub>E</sub>	0.305	0.313	0.320	7.75	7.94	8.13
L	0.030	0.040	0.050	0.76	1.02	1.27
L1	0.020 REF			0.51 REF		

### Ordering Information

Device	Package	Shipping
SZ5KASMCxxAT3G	SMC (Pb-Free)	2,500 / Tape & Reel
SZ5KASMCxxCAT3G	SMC (Pb-Free)	2,500 / Tape & Reel

# SZ5KASMC Series

## Automotive, Surface Mount 5000 W in DO-214AB

### Part Numbering System

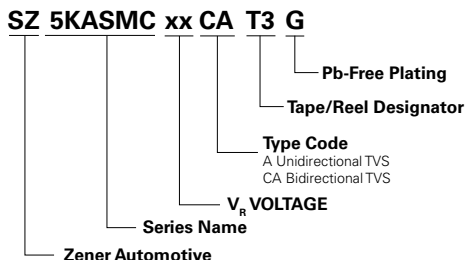

### Part Marking System

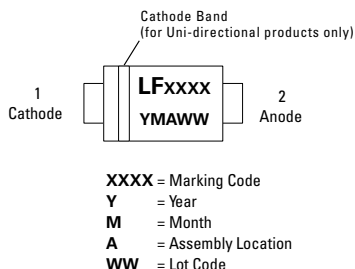

### Tape and Reel Specification

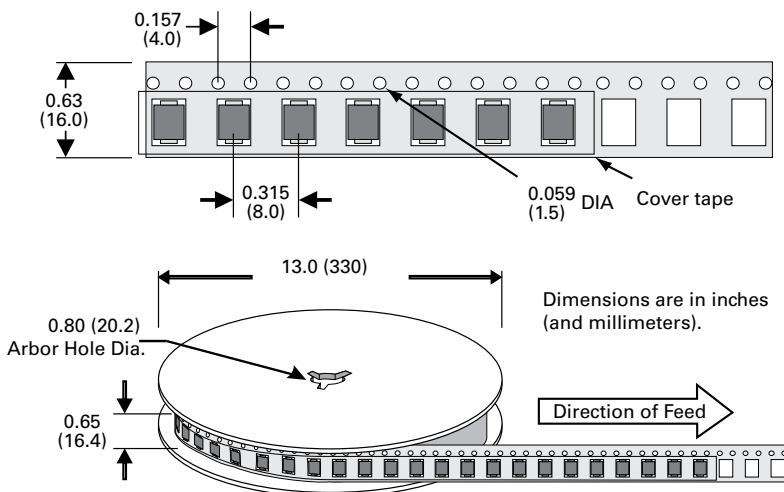

**Disclaimer Notice** - Information furnished is believed to be accurate and reliable. However, users should independently evaluate the suitability of and test each product selected for their own applications. Littelfuse products are not designed for, and may not be used in, all applications. Read complete Disclaimer Notice at <http://www.littelfuse.com/disclaimer-electronics>.