



GRTE18S-P2442

GR18S

PHOTOELECTRIC SENSORS

SICK
Sensor Intelligence.



Illustration may differ



Ordering information

Type	Part no.
GRTE18S-P2442	1069579

Other models and accessories → www.sick.com/GR18S

Detailed technical data

Features

Sensor/detection principle	Photoelectric proximity sensor, energetic
Housing design (light emission)	Cylindrical, straight
Thread diameter (housing)	M18 x 1
Optical axis	Axial
Sensing range max.	5 mm ... 550 mm ¹⁾
Sensing range	10 mm ... 400 mm ¹⁾
Type of light	Visible red light
Light source	PinPoint LED ²⁾
Light spot size (distance)	Ø 9 mm (400 mm)
Wave length	650 nm
Adjustment	Potentiometer, 270°

¹⁾ Object with 90 % reflectance (referred to standard white, DIN 5033).

²⁾ Average service life: 100,000 h at T_J = +25 °C.

Mechanics/electronics

Supply voltage	10 V DC ... 30 V DC ¹⁾
Ripple	± 5 V _{pp} ²⁾

¹⁾ Limit values when operated in short-circuit protected network: max. 8 A.

²⁾ May not exceed or fall below U_v tolerances.

³⁾ At U_v > 24 V or ambient temperature > 49 °C, I_A max. = 50 mA.

⁴⁾ Signal transit time with resistive load.

⁵⁾ With light/dark ratio 1:1.

⁶⁾ A = V_S connections reverse-polarity protected.

⁷⁾ B = inputs and output reverse-polarity protected.

⁸⁾ D = outputs overcurrent and short-circuit protected.

⁹⁾ At U_v ≤ 24V and I_A < 50mA.

Power consumption	≤ 30 mA
Output type	PNP
Output function	Complementary
Switching mode	Light/dark switching
Output current I_{max.}	100 mA ³⁾
Response time	< 1,000 μs ⁴⁾
Switching frequency	500 Hz ⁵⁾
Connection type	Male connector M12, 4-pin
Circuit protection	A ⁶⁾ B ⁷⁾ D ⁸⁾
Protection class	III
Housing material	Nickel-plated brass and ABS
Optics material	Plastic, PMMA
Enclosure rating	IP67
Items supplied	Fastening nuts (2 x)
EMC	EN 60947-5-2
Ambient operating temperature	-25 °C ... +55 °C ⁹⁾
Ambient storage temperature	-40 °C ... +70 °C
UL File No.	NRKH.E348498 & NRKH7.E348498

1) Limit values when operated in short-circuit protected network: max. 8 A.

2) May not exceed or fall below U_v tolerances.

3) At U_v > 24 V or ambient temperature > 49 °C, I_A max. = 50 mA.

4) Signal transit time with resistive load.

5) With light/dark ratio 1:1.

6) A = V_S connections reverse-polarity protected.

7) B = inputs and output reverse-polarity protected.

8) D = outputs overcurrent and short-circuit protected.

9) At U_v ≤ 24V and I_A < 50mA.

Classifications

ECl@ss 5.0	27270903
ECl@ss 5.1.4	27270903
ECl@ss 6.0	27270903
ECl@ss 6.2	27270903
ECl@ss 7.0	27270903
ECl@ss 8.0	27270903
ECl@ss 8.1	27270903
ECl@ss 9.0	27270903
ETIM 5.0	EC001821
ETIM 6.0	EC001821
UNSPSC 16.0901	39121528

Adjustments possible

GRTB18(S), GRTE18(S), Sensing rang setting: Potentiometer, 270°

Sensing range

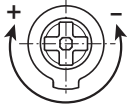

Connection diagram

Cd-084

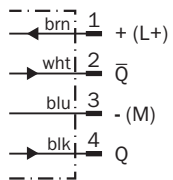

Characteristic curve

GRTE18S, 400 mm

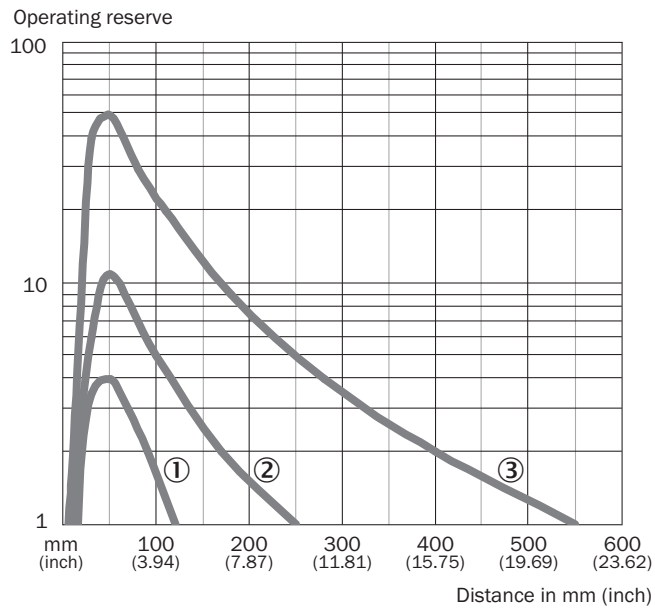

- ① Sensing range on black, 6% remission
- ② Sensing range on gray, 20 % remission
- ③ Sensing range on white, 90% remission

Light spot size

GRTE18S, 400 mm

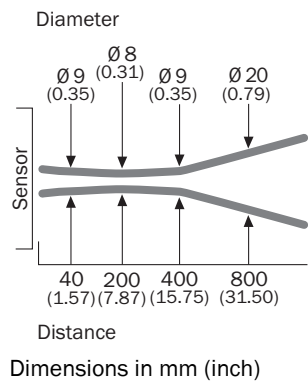

Sensing range diagram

GRTE18S, 400 mm

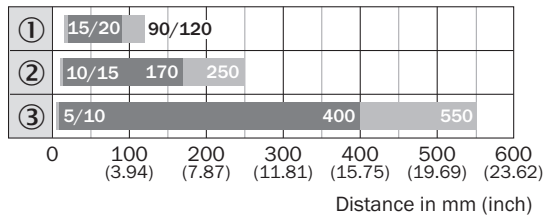

- Sensing range ■ Sensing range max.
- ① Sensing range on black, 6% remission
- ② Sensing range on gray, 20 % remission
- ③ Sensing range on white, 90% remission

Dimensional drawing (Dimensions in mm (inch))

GR18S, metal, connector, straight, adjustable

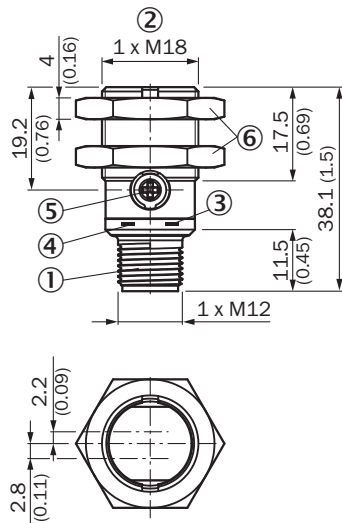







- ① Connector M12, 3-pin
- ② Threaded mounting hole M18 x 1
- ③ LED indicator yellow
- ④ LED indicator green
- ⑤ Sensitivity control: potentiometer 270°
- ⑥ Fastening nuts (2x); width across 24, metal

Recommended accessories

Other models and accessories → www.sick.com/GR18S

	Brief description	Type	Part no.
Universal bar clamp systems			
	Plate N06 for universal clamp bracket, M18, Zinc plated steel (sheet), Zinc die cast (clamping bracket), Universal clamp (5322626), mounting hardware	BEF-KHS-N06	2051612

	Brief description	Type	Part no.
Mounting brackets and plates			
	Mounting plate for M18 sensors, steel, zinc coated, without mounting hardware	BEF-WG-M18	5321870
	Mounting bracket for M18 sensors, steel, zinc coated, without mounting hardware	BEF-WN-M18	5308446
Terminal and alignment brackets			
	Mounting bracket with ball-and-socket, Plastic, mounting hardware included	BEF-WN-M18-ST02	5312973
	Clamping block for round sensors M18, without fixed stop, plastic (PA12), glass-fiber reinforced, mounting hardware included	BEF-KH-M18	2051481
	Clamping block for round sensors M18, with fixed stop, plastic (PA12), glass-fiber reinforced, mounting hardware included	BEF-KHF-M18	2051482
	Integrated adapter, Plastic (PA12)	BEF-WN-MH15-1	4039533
	Mounting ring, Stainless steel, without mounting hardware	BEF-WN-MH15-2V	4053358

SICK AT A GLANCE

SICK is one of the leading manufacturers of intelligent sensors and sensor solutions for industrial applications. A unique range of products and services creates the perfect basis for controlling processes securely and efficiently, protecting individuals from accidents and preventing damage to the environment.

We have extensive experience in a wide range of industries and understand their processes and requirements. With intelligent sensors, we can deliver exactly what our customers need. In application centers in Europe, Asia and North America, system solutions are tested and optimized in accordance with customer specifications. All this makes us a reliable supplier and development partner.

Comprehensive services complete our offering: SICK LifeTime Services provide support throughout the machine life cycle and ensure safety and productivity.

For us, that is “Sensor Intelligence.”

WORLDWIDE PRESENCE:

Contacts and other locations –www.sick.com