

[Docs](#) » [Get Started](#) » [ESP-WROVER-KIT V4.1 Getting Started Guide](#)

---

# ESP-WROVER-KIT V4.1 Getting Started Guide

[\[中文\]](#)

This user guide shows how to get started with the ESP-WROVER-KIT V4.1 development board including description of its functionality and configuration options. For descriptions of other versions of the ESP-WROVER-KIT check [ESP32 Hardware Reference](#).

If you would like to start using this board right now, go directly to the [Start Application Development](#) section.

## What You Need

- 1 × [ESP-WROVER-KIT V4.1 board](#)
- 1 x Micro USB 2.0 Cable, Type A to Micro B
- 1 × PC loaded with Windows, Linux or Mac OS

## Overview

The ESP-WROVER-KIT is a development board built around the ESP32 and produced by Espressif. This board is compatible with multiple ESP32 modules, including the ESP32-WROOM-32, ESP32-WROVER and ESP32-WROVER-B. The ESP-WROVER-KIT features support for an LCD and a MicroSD card. The I/O pins have been broken out from the ESP32 module for easy extension. The board carries an advanced multi-protocol USB bridge (the FTDI FT2232HL), enabling developers to use JTAG directly to debug the ESP32 through the USB interface. The development board makes secondary development easy and cost-effective.

## Functionality Overview

The block diagram below illustrates the ESP-WROVER-KIT's main components and their interconnections.

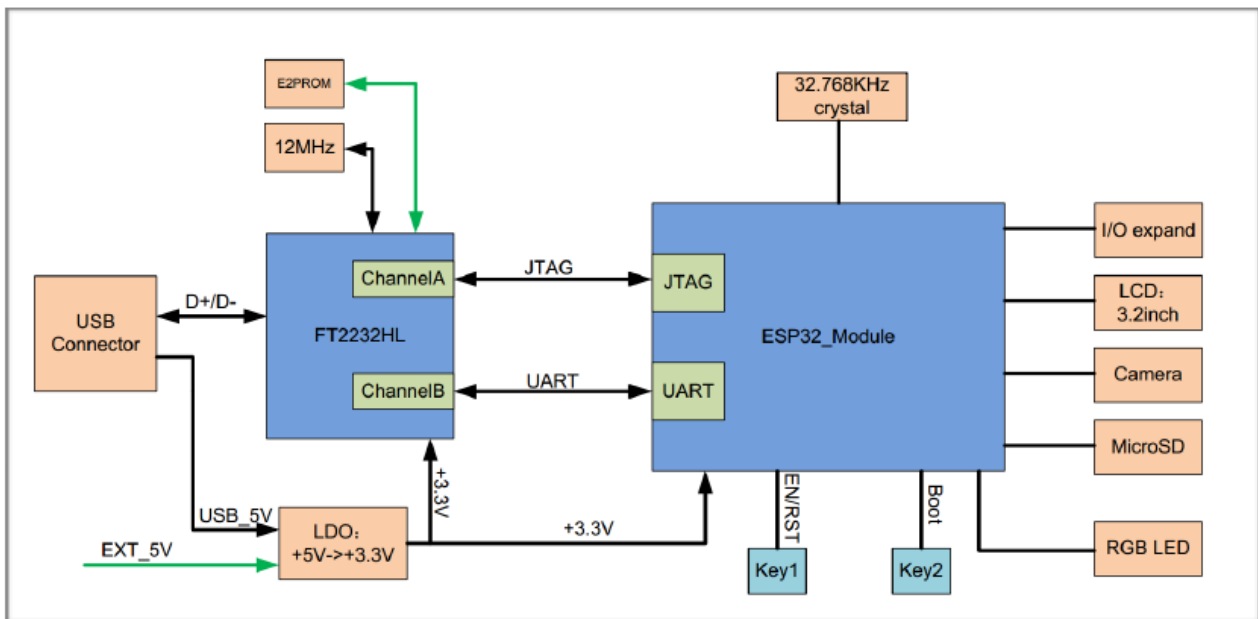

ESP-WROVER-KIT block diagram

## Functional Description

The following lists and figures describe the key components, interfaces, and controls of ESP-WROVER-KIT board.

### 32.768 kHz

An external precision 32.768 kHz crystal oscillator provides a low-power consumption clock used during Deep-Sleep mode.

### FT2232

The FT2232 chip is a multi-protocol USB-to-serial bridge. Users can control and program the FT2232 chip through the USB interface to establish communication with ESP32. The FT2232 chip also features USB-to-JTAG interface. USB-to-JTAG is available on channel A of the FT2232, whilst USB-to-serial is on channel B. The embedded FT2232 chip is one of the distinguishing features of the ESP-WROVER-KIT. It enhances users' convenience in terms of application development and debugging. In addition, users need not purchase a JTAG debugger separately, which reduces the development cost, see [ESP-WROVER-KIT V4.1 schematic](#).

OR

A zero Ohm resistor intended as a placeholder for a current shunt. May be desoldered or replaced with a current shunt to facilitate measurement of current required by ESP32 module depending on power mode.

## ESP32-WROVER

This version of ESP-WROVER-KIT board has ESP-WROVER-B module installed that integrates 64-Mbit PSRAM for flexible extended storage and data processing capabilities. The board can accommodate other versions of ESP modules described under [WROOM](#), [SOLO](#) and [WROVER Modules](#).

### Note

GPIO16 and GPIO17 are used as the CS and clock signal for PSRAM. To ensure reliable performance, the two GPIOs are not broken out.

## Diagnostic LEDs

Four red LEDs connected to GPIO pins of the FT2232 chip. Intended for future use.

## UART

Serial port: the serial TX/RX signals on the FT2232HL and the ESP32 are broken out to each side of JP2. By default, the two signals are connected with jumpers. To use the ESP32 module serial interface only, the jumpers may be removed and the module can be connected to another external serial device.

## SPI

SPI interface used by ESP32 to access flash and PSRAM memories inside the module. Please note that the voltage level on this interface depends on the module used.

## CTS/RTS

Serial port flow control signals: the pins are not connected to the circuitry by default. To enable them, respective pins of JP14 must be shorted with jumpers.

## JTAG

JTAG interface: the JTAG signals on FT2232HL and ESP32 are broken out to the two sides of JP2. By default, the two signals are disconnected. To enable JTAG, shorting jumpers are required on the signals as shown in section [Setup Options](#).

## USB Port

USB interface. It functions as the power supply for the board and the communication interface between PC and ESP32 module.

## EN Button

Reset button: pressing this button resets the system.

## Boot Button

Download button: holding down the **Boot** button and pressing the **EN** button initiates the firmware download mode. Then user can download firmware through the serial port.

## Power Switch

Power on/off button: toggling to the right powers the board on; toggling to the left powers the board off.

## Power Selector

Power supply selection interface: the ESP-WROVER-KIT can be powered through the USB interface or the 5V Input interface. The user can select the power supply with a jumper. More details can be found in section [Setup Options](#), jumper header JP7.

## 5V Input

The 5V power supply interface is used as a backup power supply in case of full-load operation.

## 5V Power On LED

This red LED indicates that a power supply (either from **USB** or **5V Input**) is applied to the board.

## LDO

NCP1117(1A). 5V-to-3.3V LDO. (There is an alternative pin-compatible LDO — LM317DCY, with an output current of up to 1.5A). NCP1117 can provide a maximum current of 1A. The LDO solutions are available with both fixed output voltage and variable output voltage. For details please refer to [ESP-WROVER-KIT V4.1 schematic](#).

## Camera Connector

Camera interface: a standard OV7670 camera module is supported.

## RGB LED

Red, green and blue (RGB) light emitting diodes (LEDs), which may be controlled by pulse width modulation (PWM).

## I/O Connector

All the pins on the ESP32 module are led out to the pin headers on the ESP-WROVER-KIT. Users can program ESP32 to enable multiple functions such as PWM, ADC, DAC, I2C, I2S, SPI, etc.

## Micro SD Card Slot

Develop applications that access Micro SD card for data storage and retrieval.

## LCD

ESP-WROVER-KIT supports mounting and interfacing a 3.2" SPI (standard 4-wire Serial Peripheral Interface) LCD, as shown on figure [ESP-WROVER-KIT board layout - back](#).

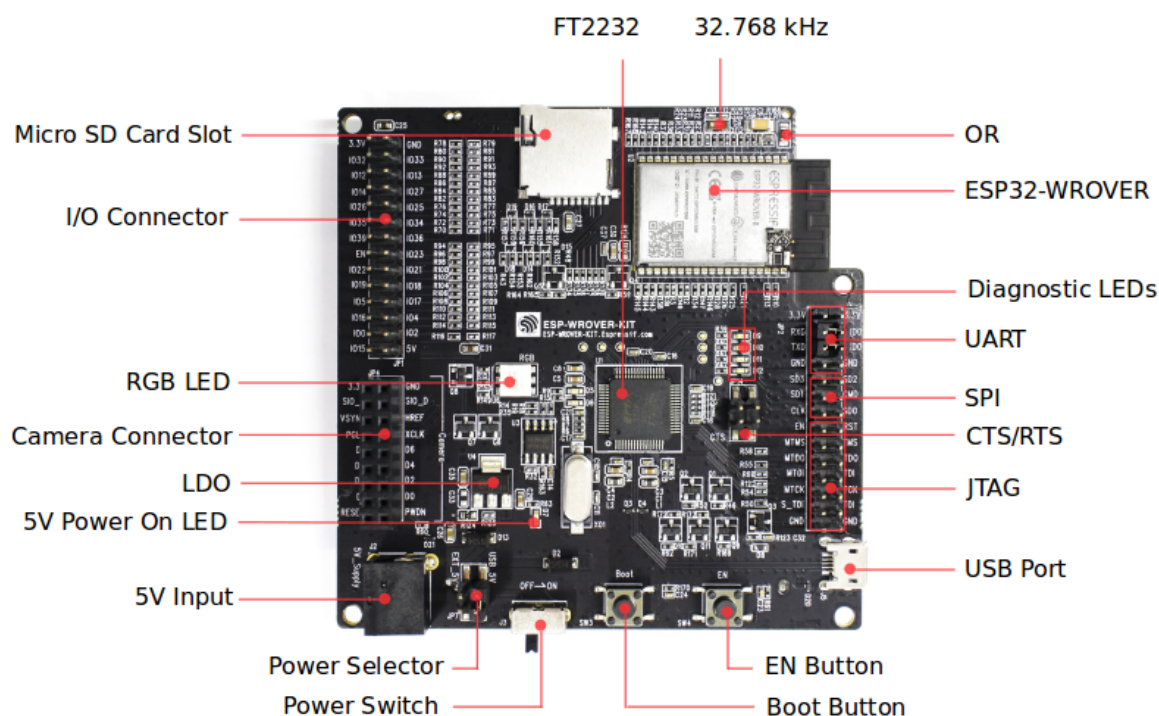

*ESP-WROVER-KIT board layout - front*

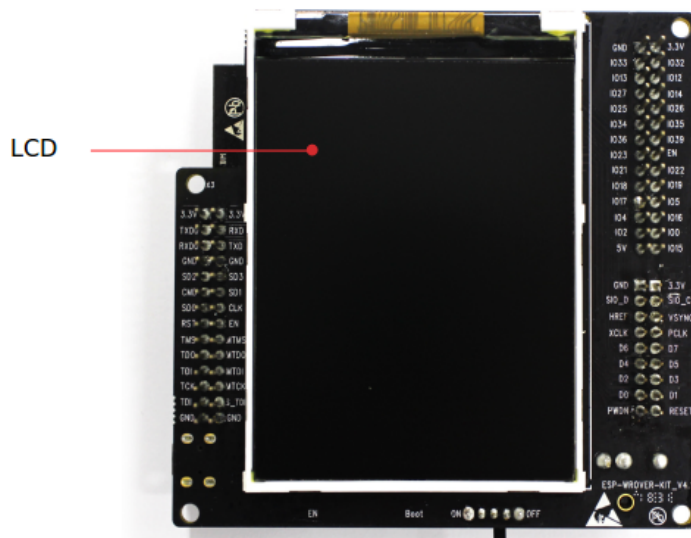

ESP-WROVER-KIT board layout - back

## Setup Options

There are three jumper headers available to set up the board functionality. Typical options to select from are listed in table below.

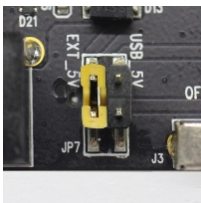
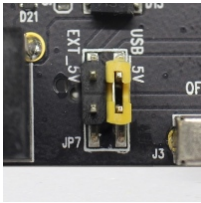
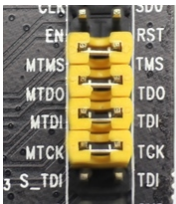
Header	Jumper Setting	Description of Functionality
JP7		Power ESP-WROVER-KIT board from an external power supply
JP7		Power ESP-WROVER-KIT board from an USB port
JP2		Enable JTAG functionality

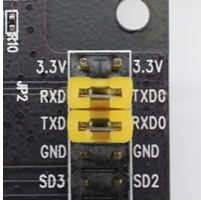
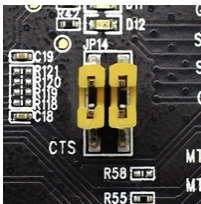
JP2		Enable UART communication
JP14		Enable RTS/CTS flow control for serial communication

## Allocation of ESP32 Pins

Several pins / terminals of ESP32 module are allocated to the on board hardware. Some of them, like GPIO0 or GPIO2, have multiple functions. If certain hardware is not installed, e.g. nothing is plugged in to the Camera / JP4 header, then selected GPIOs may be used for other purposes.

### Main I/O Connector / JP1

The JP1 connector is shown in two columns in the middle under “I/O” headers. The two columns “Shared With” outside, describe where else on the board certain GPIO is used.

Shared With	I/O	I/O	Shared With
NC/XTAL	IO32	IO33	NC/XTAL
JTAG, MicroSD	IO12	IO13	JTAG, MicroSD
JTAG, MicroSD	IO14	IO27	Camera
Camera	IO26	IO25	Camera, LCD
Camera	IO35	IO34	Camera
Camera	IO39	IO36	Camera
JTAG	EN	IO23	Camera, LCD
Camera, LCD	IO22	IO21	Camera, LCD, MicroSD
Camera, LCD	IO19	IO18	Camera, LCD

Camera, LCD	IO5	IO17	PSRAM
PSRAM	IO16	IO4	LED, Camera, MicroSD
Camera, LED, Boot	IO0	IO2	LED, MicroSD
JTAG, MicroSD	IO15	5V	

Legend:

- NC/XTAL - [32.768 kHz Oscillator](#)
- JTAG - [JTAG / JP8](#)
- Boot - Boot button / SW2
- Camera - [Camera / JP4](#)
- LED - [RGB LED](#)
- MicroSD - [MicroSD Card / J4](#)
- LCD - [LCD / U5](#)
- PSRAM - ESP32-WROVER's PSRAM, if ESP32-WROVER is installed

## 32.768 kHz Oscillator

.	ESP32 Pin
1	GPIO32
2	GPIO33

### **Note**

As GPIO32 and GPIO33 are connected to the oscillator, they are not connected to JP1 I/O expansion connector to maintain signal integrity. This allocation may be changed from oscillator to JP1 by desoldering the OR resistors from positions R11 / R23 and installing them in positions R12 / R24.

## SPI Flash / JP2

.	ESP32 Pin
1	CLK / GPIO6
2	SD0 / GPIO7



3	SD1 / GPIO8
4	SD2 / GPIO9
5	SD3 / GPIO10
6	CMD / GPIO11

### ❗ Important

The module's flash bus is connected to the pin header JP2 through 0-Ohm resistors R140 ~ R145. If the flash frequency needs to operate at 80 MHz for reasons such as improving the integrity of bus signals, it is recommended that resistors R140 ~ R145 be desoldered. At this point, the module's flash bus is disconnected with the pin header JP2.

## JTAG / JP2

.	ESP32 Pin	JTAG Signal
1	EN	TRST_N
2	MTMS / GPIO14	TMS
3	MTDO / GPIO15	TDO
4	MTDI / GPIO12	TDI
5	MTCK / GPIO13	TCK

## Camera / JP4

.	ESP32 Pin	Camera Signal
1	n/a	3.3V
2	n/a	Ground
3	GPIO27	SIO_C / SCCB Clock
4	GPIO26	SIO_D / SCCB Data
5	GPIO25	VSYNC / Vertical Sync
6	GPIO23	HREF / Horizontal Reference

7	GPIO22	PCLK / Pixel Clock
8	GPIO21	XCLK / System Clock
9	GPIO35	D7 / Pixel Data Bit 7
10	GPIO34	D6 / Pixel Data Bit 6
11	GPIO39	D5 / Pixel Data Bit 5
12	GPIO36	D4 / Pixel Data Bit 4
13	GPIO19	D3 / Pixel Data Bit 3
14	GPIO18	D2 / Pixel Data Bit 2
15	GPIO5	D1 / Pixel Data Bit 1
16	GPIO4	D0 / Pixel Data Bit 0
17	GPIO0	RESET / Camera Reset
18	n/a	PWDN / Camera Power Down

- Signals D0 .. D7 denote camera data bus

## RGB LED

.	ESP32 Pin	RGB LED
1	GPIO0	Red
2	GPIO2	Green
3	GPIO4	Blue

## MicroSD Card / J4

.	ESP32 Pin	MicroSD Signal
1	MTDI / GPIO12	DATA2
2	MTCK / GPIO13	CD / DATA3
3	MTDO / GPIO15	CMD
4	MTMS / GPIO14	CLK

5	GPIO2	DATA0
6	GPIO4	DATA1
7	GPIO21	CD

## LCD / U5

.	ESP32 Pin	LCD Signal
1	GPIO18	RESET
2	GPIO19	SCL
3	GPIO21	D/C
4	GPIO22	CS
5	GPIO23	SDA
6	GPIO25	SDO
7	GPIO5	Backlight

## Start Application Development

Before powering up the ESP-WROVER-KIT, please make sure that the board has been received in good condition with no obvious signs of damage.

### Initial Setup

Select the source of power supply for the board by setting jumper JP7. The options are either **USB** port or an external **5V Input**. For this application, the selection of the USB port is sufficient. Enable UART communication by installing jumpers on JP2. Both selections are shown in table below.

Power up from USB port	Enable UART communication

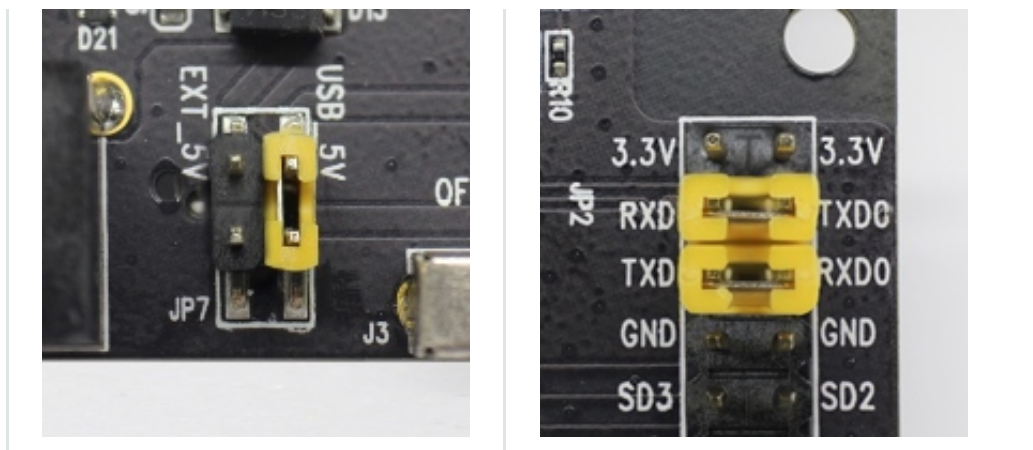

Do not install any other jumpers.

Turn the **Power Switch** on. The **5V Power On LED** should turn on.

## Now to Development

To start development of applications for ESP-WROVER-KIT, proceed to the [Get Started](#) section which will walk you through the following steps:

- [Setup Toolchain](#) in your PC to develop applications for ESP32 in C language
- [Connect](#) the module to the PC and verify if it is accessible
- [Build and Flash](#) an example application to the ESP32
- [Monitor](#) instantly what the application is doing

## Related Documents

- [ESP-WROVER-KIT V4.1 schematic](#) (PDF)
- [ESP32 Datasheet](#) (PDF)
- [ESP32-WROVER-B Datasheet](#) (PDF)
- [JTAG Debugging](#)
- [ESP32 Hardware Reference](#)