

Features

- 350W peak pulse power ($t_p = 8/20\mu s$)
- Bidirectional configurations
- Solid-state silicon-avalanche technology
- Low clamping voltage
- Low leakage current
- IEC 61000-4-2 $\pm 30kV$ contact $\pm 30kV$ air
- IEC 61000-4-4 (EFT) 40A(5/50ns)
- IEC 61000-4-5 (Lightning) 12A(8/20 μs)

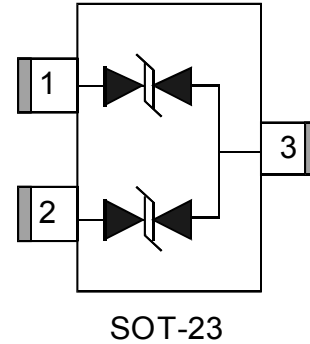

Applications

- Dataline
- Automatic Teller Machines
- Net works
- Power line

Mechanical Data

- SOT-23 package
- Molding compound flammability rating: UL 94V-0
- Packaging: Tape and Reel
- RoHS/WEEE Compliant

Absolute Maximum Rating

Rating	Symbol	Value	Units
Peak Pulse Power ($t_p = 8/20\mu s$)	P_{pp}	350	W
Peak Pulse Current ($t_p = 8/20\mu s$)(note1)	I_{pp}	12	A
ESD per IEC 61000-4-2(Air) ESD per IEC 61000-4-2(Contact)	V_{ESD}	30 30	kV
Lead Soldering Temperature	T_L	260/10S	$^{\circ}C$
Junction Temperature	T_J	-55 to + 125	$^{\circ}C$
Storage Temperature	T_{stg}	-55 to + 125	$^{\circ}C$

Electrical Characteristics

Parameter	Symbol	Conditions	Min	Typical	Max	Units
Reverse Stand-Off Voltage	V_{RWM}				12	V
Reverse Breakdown Voltage	V_{BR}	$I_T=1mA$	13.3	15.0	17.0	V
Reverse Leakage Current	I_R	$V_{RWM}=12V, T=25\text{ }^\circ\text{C}$		0.1	0.5	μA
Peak Pulse Current	I_{PP}	$t_p=8/20\mu\text{s}$			12	A
Clamping Voltage	V_C	$I_{PP}=12A, t_p=8/20\mu\text{s}$			35	V
Junction Capacitance	C_j	$V_R=0V, f=1\text{MHz}$ (Pin1、Pin2 to Pin3)		30	35	pF

Typical Characteristics

Figure 1: Peak Pulse Power vs. Pulse Time

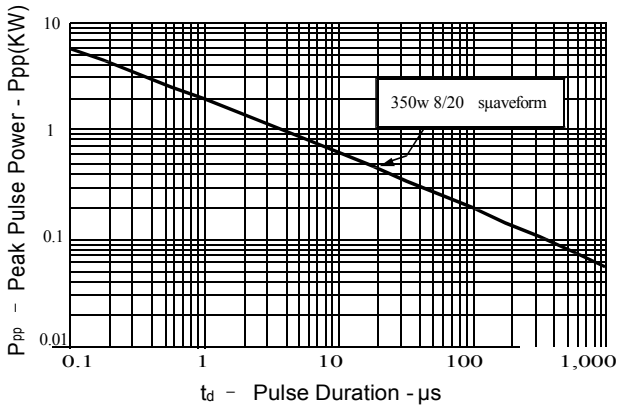

Figure 2: Power Derating Curve

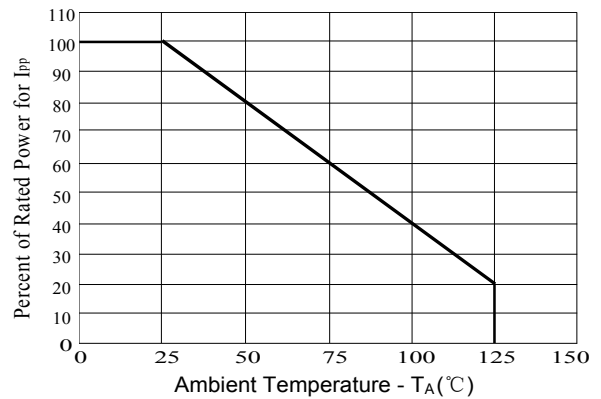

Figure3: Pulse Waveform

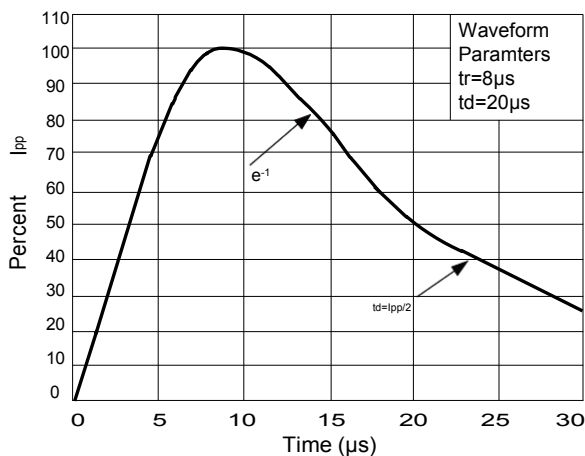
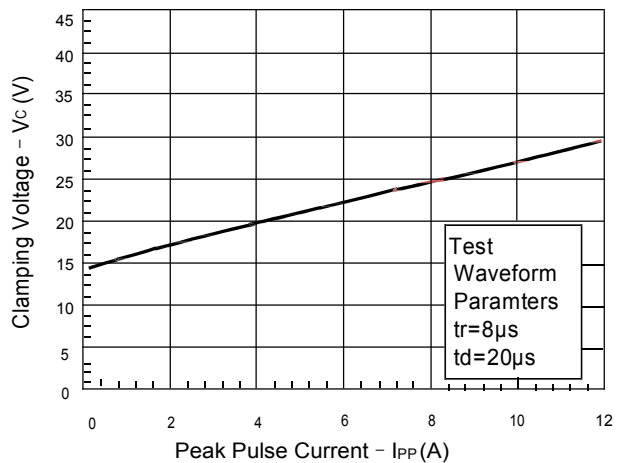
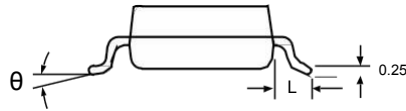
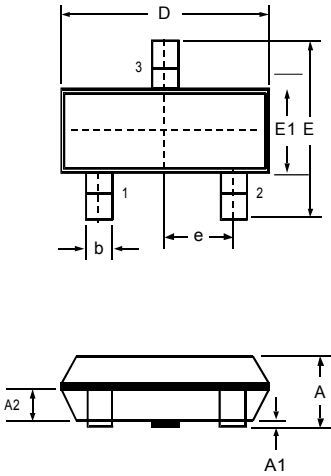

Figure 4: Clamping Voltage vs. Ipp



Outline Drawing – SOT-23



SYMBOL	DIMENSIONS			
	MILLIMETER		INCHES	
	MIN	MAX	MIN	MAX
A	0.900	1.150	0.035	0.045
A1	0.000	0.100	0.000	0.004
A2	0.900	1.050	0.035	0.041
D	2.800	3.000	0.110	0.118
b	0.300	0.500	0.012	0.020
E	2.250	2.550	0.089	0.100
E1	1.200	1.400	0.047	0.055
e	0.950 BSC		0.037 BSC	
L	0.500	0.675	0.020	0.027
θ	0	8°	0	8°

Marking

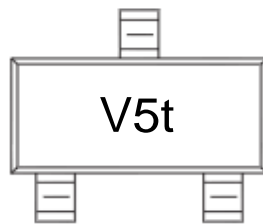

Ordering information

Order code	Package	Baseqty	Deliverymode
UMW PESD12VL2BT	SOT-23	3000	Tape and reel