

## MGA-444940-02 4.4 - 4.9 GHz 10W High Efficiency High Power Amplifier

### FEATURES

- GaN Based High Power Amplifier
- 20% Efficiency at 33 dBm Linear Output Power
- 40 dBm P<sub>-3dB</sub>
- 33 dBm Linear Pout @ 2.5% EVM (802.11 64QAM)
- 12 dB Gain
- Fully Matched Input and Output for Easy Cascade
- +28V Bias Voltage
- RoHS Compliant Surface Mount Package
- MTTF > 100 years @ 85C Ambient Temperature

### APPLICATIONS

- Telemetry
- Avionics
- Private Microwave Network Systems
- Military Wireless Communications

### DESCRIPTION

The MGA-444940-02 is a power amplifier with the State-of-the-Art linear power-added-efficiency between 4.4 GHz and 4.9 GHz frequency band. Based on advanced robust GaN device technology, the power-added-efficiency of this power amplifier is over 20% at 2W linear burst power with 2.5% EVM and ACPR better than -38 dBc. The modulation test pattern is 802.16x 64QAM. The high efficiency linear power amplifier also has excellent reliability. Ideal applications include the driver and the output power stage of the telemetry, avionics, private microwave network systems, and military wireless communications.

### TYPICAL RF PERFORMANCE:

*V<sub>ds</sub>=28V, V<sub>gs</sub>=-3.0V, I<sub>dq</sub>=100mA, T<sub>a</sub>=25C, Z<sub>0</sub>=50ohm*

| PARAMETER                 | UNITS | TYPICAL DATA |
|---------------------------|-------|--------------|
| Frequency Range           | MHz   | 4400-4900    |
| Gain (Typ / Min)          | dB    | 12 / 10      |
| Gain Flatness (Typ / Max) | +/-dB | 1.0 / 1.5    |
| Input Return Loss         | dB    | 8            |
| Output Return Loss        | dB    | 10           |
| Output P <sub>3dB</sub>   | dBm   | 40           |
| Pout @ 2.5% EVM           | dBm   | 33           |
| Operating Current Range   | mA    | 100-400      |
| Thermal Resistance        | °C/W  | 7            |

### ABSOLUTE MAXIMUM RATINGS:

*T<sub>a</sub>=25C \**

| SYMBOL              | PARAMETERS              | UNITS | MAX        |
|---------------------|-------------------------|-------|------------|
| V <sub>ds</sub>     | Drain to Source Voltage | V     | 50         |
| V <sub>gs</sub>     | Gate to Source Voltage  | V     | 10         |
| I <sub>d</sub>      | Drain Current           | mA    | 1000       |
| I <sub>g</sub>      | Gate Current            | mA    | 10         |
| P <sub>diss</sub>   | DC Power Dissipation    | W     | 50         |
| P <sub>in max</sub> | RF Input Power          | dBm   | +33        |
| T <sub>ch</sub>     | Channel Temperature     | °C    | 175        |
| T <sub>stg</sub>    | Storage Temperature     | °C    | -55 to 150 |

Exceeding any on of these limits may cause permanent damage.

# MGA-444940-02

## 4.4 - 4.9 GHz 10W High Efficiency High Power Amplifier

TYPICAL RF PERFORMANCE:  $V_{ds}=28V$ ,  $V_{gs}=-3.0V$ ,  $I_{dq}=100mA$ ,  $T_a=25C$ ,  $Z_0=50ohm$

Gain Response vs. Frequency

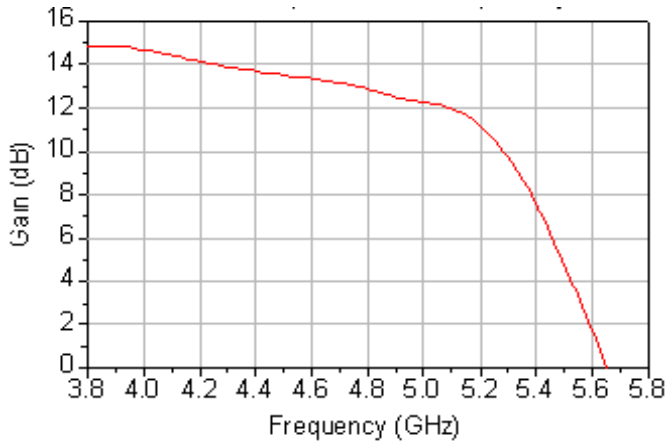

Return Loss vs. Frequency

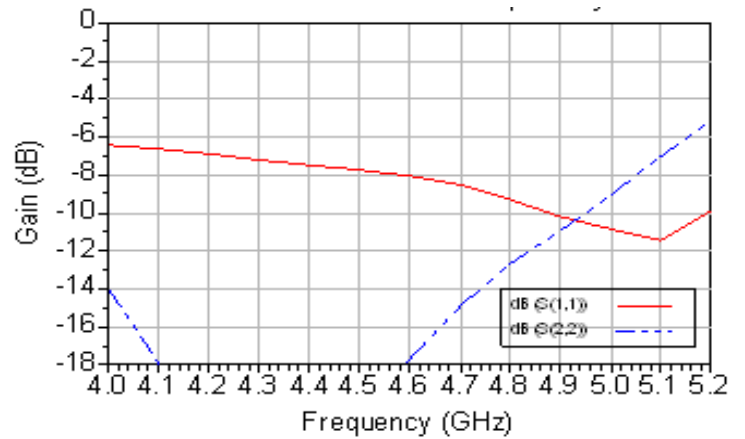

Pout vs. Pin Fo=4.5GHz Vdd=28 Vdc Idq=121 mA

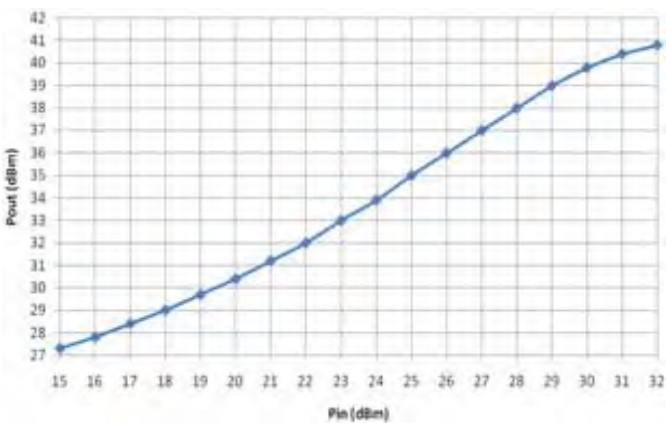

Pout @ LSG=9dB vs. Frequency vs. Sample

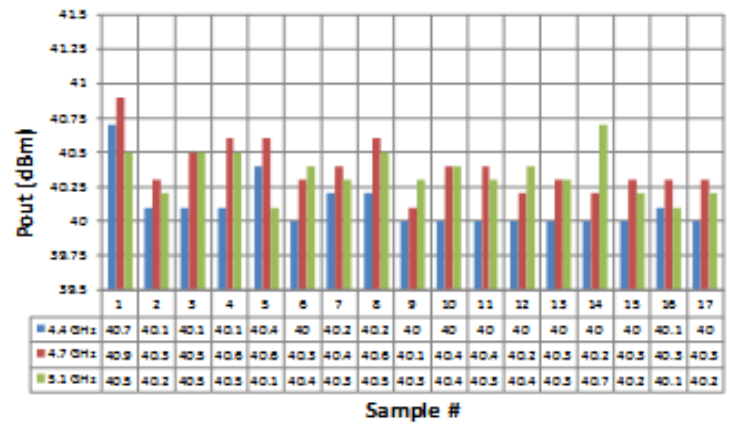

Burst Power @ 2.5% EVM, Drain Efficiency vs. Frequency

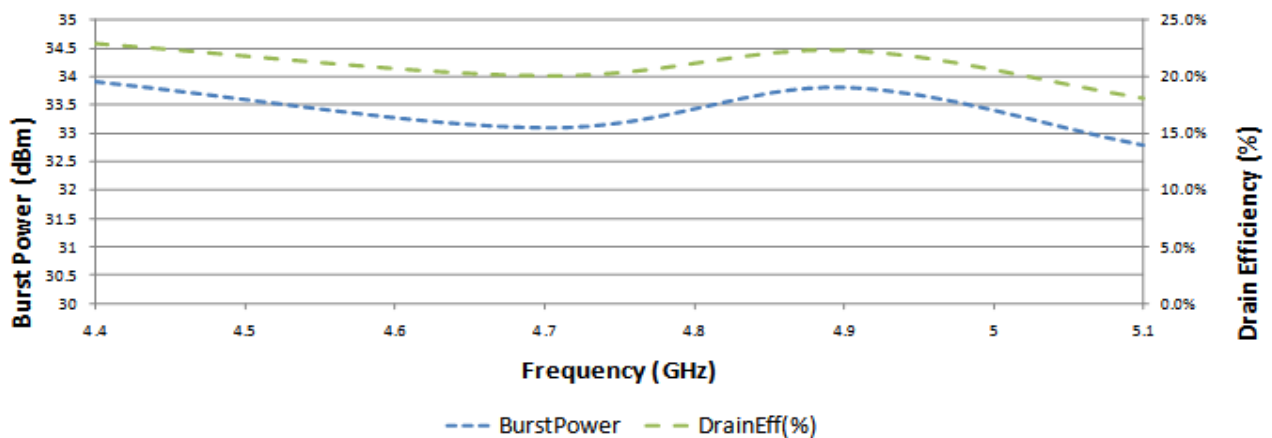

## APPLICATION NOTE

The evaluation board material, shown in Figure 1, is Rogers 4003 material, 20 mil thick, and 2 oz copper weight and is used to evaluate the MGA444924-02 hardware. The 10 watt device in the '02' package has a limited temperature range of approximately 85°C. An earless flange or flange package is offered with better Tj<sub>c</sub> and can be used at much higher temperatures. Please consult the factory for your specific application. Through holes with a diameter of 20 mils are placed uniformly over the center pad for thermal relief and RF ground.

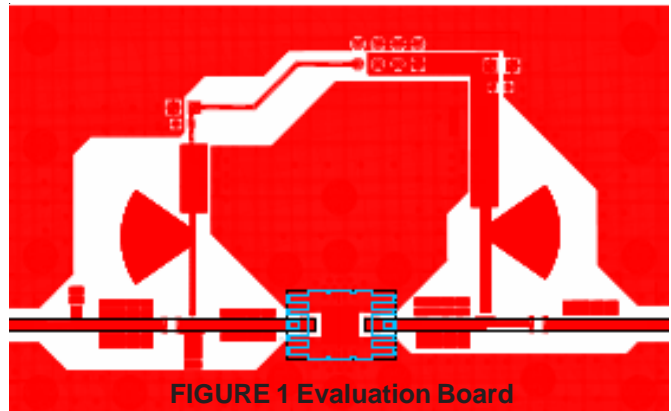

It is recommended that via holes be placed near the DC bias connector to maintain ground continuity between the top layer and bottom ground planes. Mounting holes near the unit will help secure the board to the chassis, minimize ground current loops and improve thermal conductivity in the absence of sweat soldering the board to the chassis. Biasing with quarter-wave stubs at the gate and drain are shown in Figure 1. The impedance of the quarter wave structures is cyclical with frequency. A RF short is observed at frequencies that are even multiples of quarter-wavelength and open impedance is observed at frequencies that are odd multiples of a quarter-wavelength. A 56 ohm resistor is added in series to the gate bias. The effective impedance is increased which reduces the risk of oscillations. The 56 ohm resistor is not shown in Figure 1. Through holes underneath the package is required to connect the top and bottom grounds and to improve thermal conductivity. The through holes can be back filled with conductive epoxy for best thermal performance. The MGA444940-02 has a noise figure less than 3.0 dB. A plot of noise figure versus frequency at I<sub>dq</sub> is shown in Figure 2. At small signal levels the amplifier operates at I<sub>dq</sub>. As the output power is increased the amplifier drive current will increase. A plot of P<sub>out</sub> versus P<sub>in</sub> shown in Figure 3 is plotted from 25 dBm to 40 dBm. The drain current I<sub>dd</sub> increases from 0.10 to 0.89 A. The RF drive level is increased incrementally and stopped when the gate leakage current of 10 mA is reached. The temperature performance for P<sub>out</sub> vs P<sub>in</sub> has a slope of -0.019 dB/!. A plot of P<sub>out</sub> vs P<sub>in</sub> at 4.7 GHz over a temperature range from 0 to 85! is shown in Figure 4.

The Burst power and ACPR data are shown in Figure 5. These measurements are recorded at EVM=2.5% across the frequency range at 4.4, 4.7, 4.9 and 5.1 GHz. A WPS44492202 amplifier is used as the drive stage and has a residual EVM error of less than 0.8%. The modulation is 802.16x and each frame cycle has a 10 msec duration and runs continuously. Equalization is enabled when measuring EVM performance. The MGA amplifier bias condition is V<sub>dd</sub>=28V and the gate voltage is adjusted for an I<sub>dq</sub>=100 mA. A diagram of test setup is shown in Figure 7 and includes the frame information about the test pattern. As the output power is backed off from the peak performance, the amplifier changes its DC/RF operation from Class 'A' to Class 'A/B'. An example of this dynamic DC/RF operation can be observe in EVM versus Burst Power performance shown in Figure 6. The EVM is optimal at 33 dBm but not at 25 dBm in which the output power is backed off and the amplifier's operating current to reduced 150 mA. At this bias condition the amplifier is back-off near pinch off.

Applications that require gating the amplifier for TDD applications can be supported using a constant current source with a command switch to disable current loop and turnoff the amplifier as shown in Figure 9. A 1% precision resistor R8 0.2 ohm is used to convert the current to voltage. Applying KVL principal around Q2 and Q3, the current through Q2 and the load current is 30 times defined by resistor network R4 over R8. As the load current is equalized, the gate voltage to the gate of the GaN is adjusted until the voltage at Q3 base and voltage at Q2 collector is balanced. A MOSFET M2 is used to enable and disable the loop. The loop bandwidth has been intentionally truncated to minimize the loop dynamics from attacking the envelope. This allows the bias current to increase as the P<sub>out</sub> increases; this is shown in Figure 8.

### APPLICATION NOTE CONTINUED

**FIGURE 2**  
Noise Figure vs. Frequency

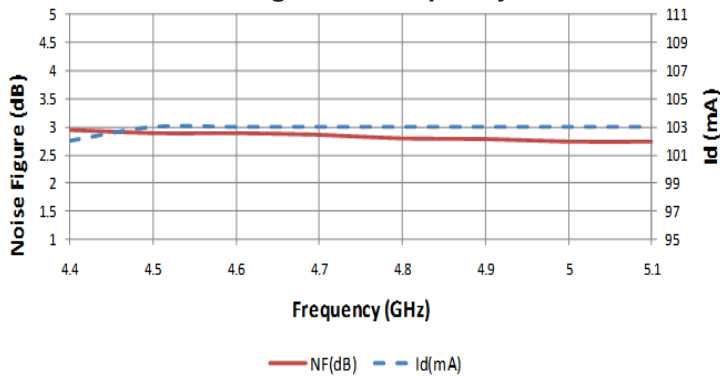

**FIGURE 3**  
Supply Current vs. Pout (CW)

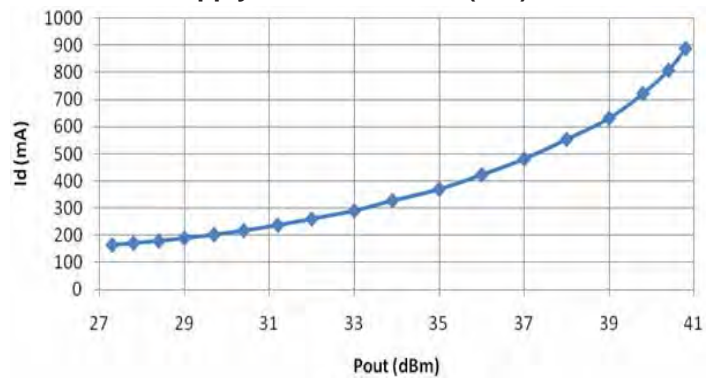

**FIGURE 4**  
Pout vs. Pin over Temperature

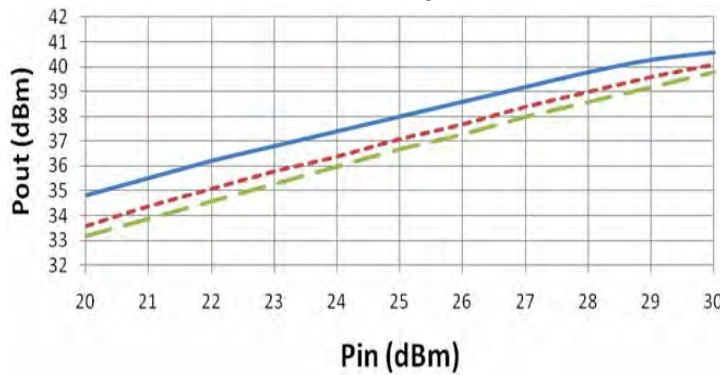

**FIGURE 5**  
Burst Power and ACPR vs. Frequency

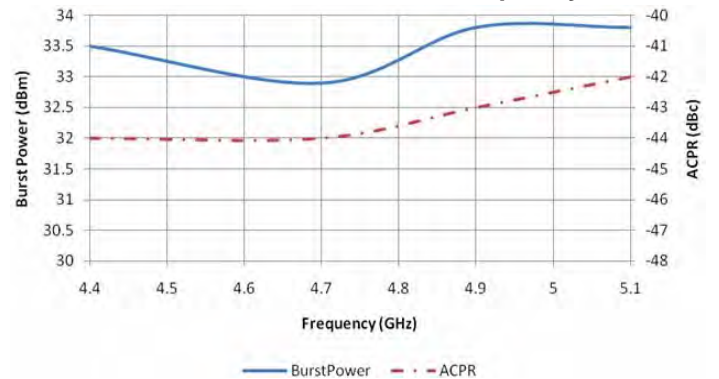

**FIGURE 6**  
EVM vs. Burst Power at 4.9 GHz Vdd=28V

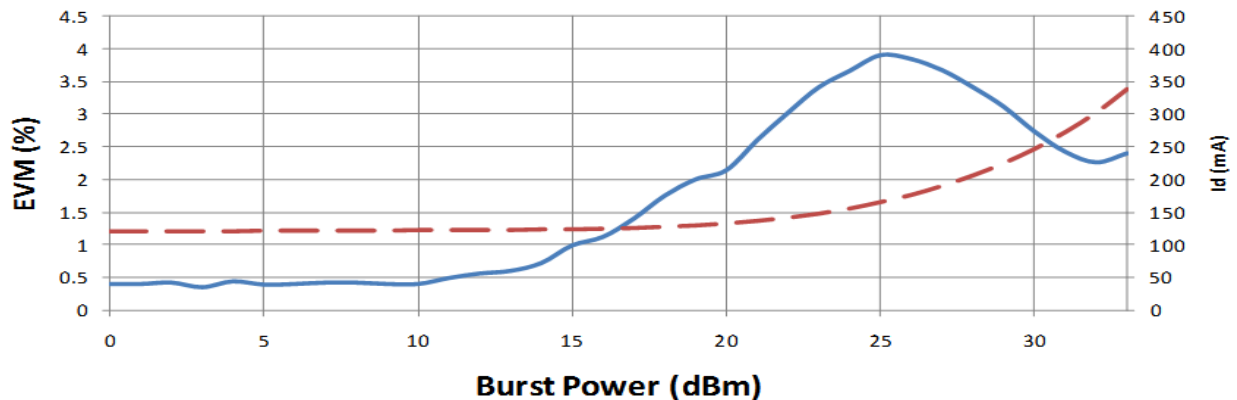

APPLICATION NOTE CONTINUED

FIGURE 7  
Burst Power and ACPR Test Setup

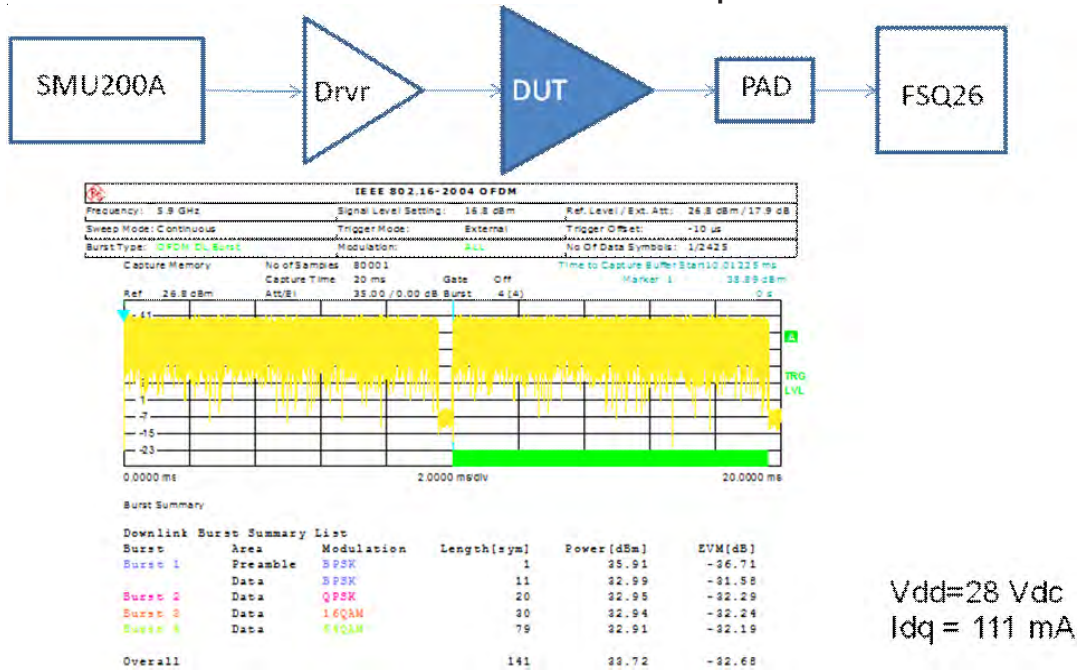
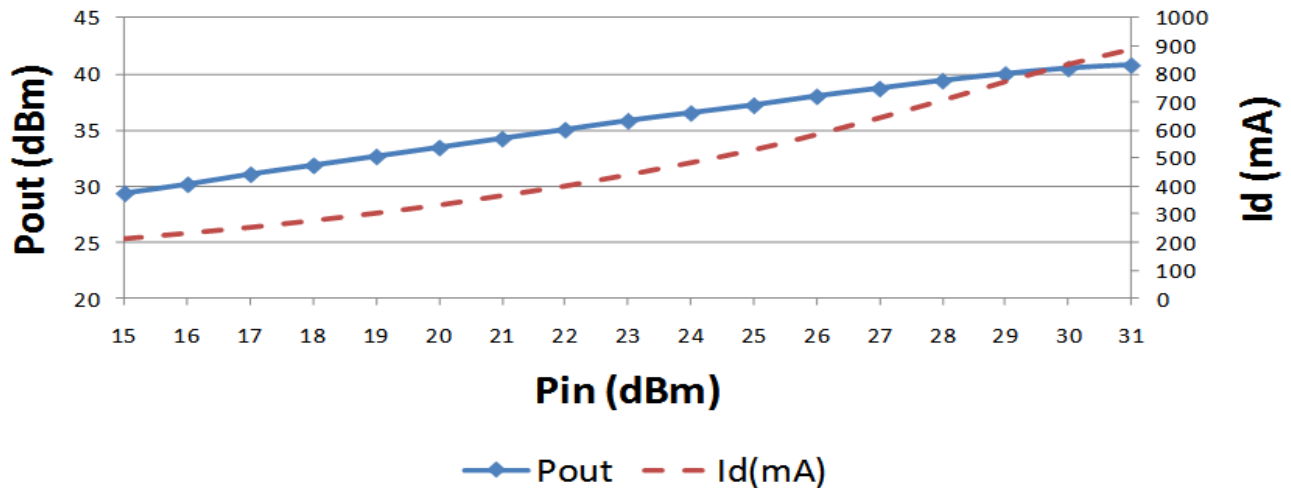
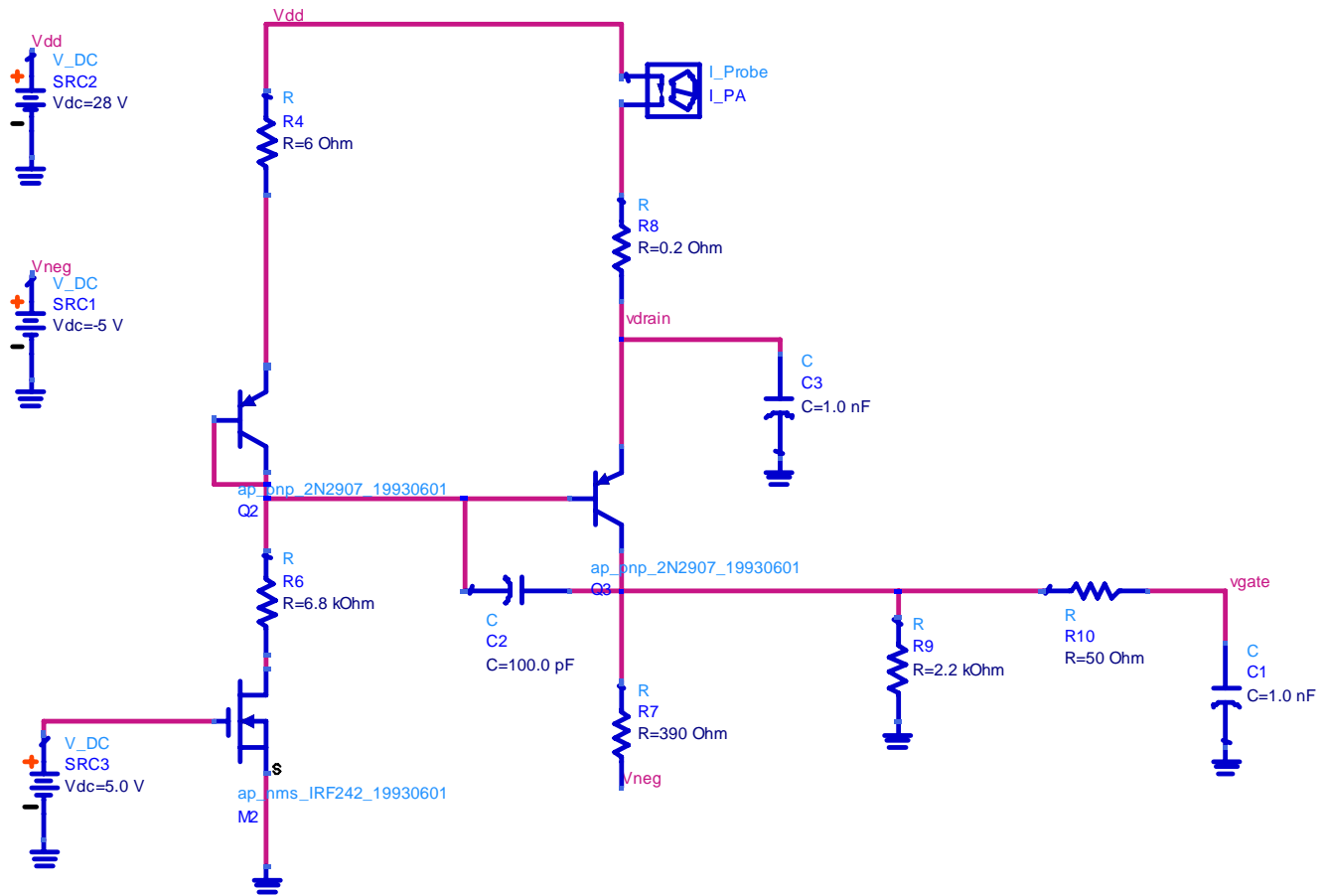

FIGURE 8  
Pout vs. Pin Using Constant Current Loop



### APPLICATION NOTE CONTINUED

**FIGURE 9**  
Schematic of Constant Current Loop



### TYPICAL SCATTERING PARAMETERS:

$V_{ds}=28V, V_{gs}=-3.0V, I_{dq}=100mA, T_a=25C, Z_0=50ohm$

| f req     | magS11 | AngS11   | magS21 | AngS21  | magS12 | AngS12  | magS22 | AngS22   |
|-----------|--------|----------|--------|---------|--------|---------|--------|----------|
| 4.000 GHz | 0.476  | -95.278  | 5.425  | 179.684 | 0.053  | 107.480 | 0.199  | 127.699  |
| 4.100 GHz | 0.466  | -114.659 | 5.255  | 165.042 | 0.052  | 91.188  | 0.128  | 122.925  |
| 4.200 GHz | 0.452  | -132.649 | 5.093  | 150.587 | 0.052  | 76.650  | 0.067  | 117.810  |
| 4.300 GHz | 0.436  | -150.169 | 4.957  | 136.380 | 0.052  | 62.494  | 0.015  | 90.628   |
| 4.400 GHz | 0.422  | -167.491 | 4.833  | 122.148 | 0.051  | 48.205  | 0.036  | -58.814  |
| 4.500 GHz | 0.410  | -175.635 | 4.738  | 107.515 | 0.052  | 34.343  | 0.084  | -68.182  |
| 4.600 GHz | 0.395  | -159.112 | 4.650  | 92.460  | 0.052  | 19.121  | 0.131  | -77.156  |
| 4.700 GHz | 0.375  | -144.029 | 4.545  | 76.604  | 0.052  | 3.774   | 0.181  | -86.306  |
| 4.800 GHz | 0.343  | -132.073 | 4.411  | 59.842  | 0.052  | -13.017 | 0.232  | -97.645  |
| 4.900 GHz | 0.308  | -126.214 | 4.218  | 43.001  | 0.051  | -29.577 | 0.285  | -109.164 |
| 5.000 GHz | 0.286  | -124.757 | 4.097  | 25.305  | 0.051  | -46.874 | 0.352  | -119.753 |
| 5.100 GHz | 0.269  | -132.149 | 3.973  | 4.531   | 0.050  | -68.273 | 0.447  | -132.674 |
| 5.200 GHz | 0.321  | -145.665 | 3.620  | -19.383 | 0.046  | -92.078 | 0.553  | -148.263 |

# MGA-444940-02

## 4.4 - 4.9 GHz 10W High Efficiency High Power Amplifier

### OUTLINE DRAWING

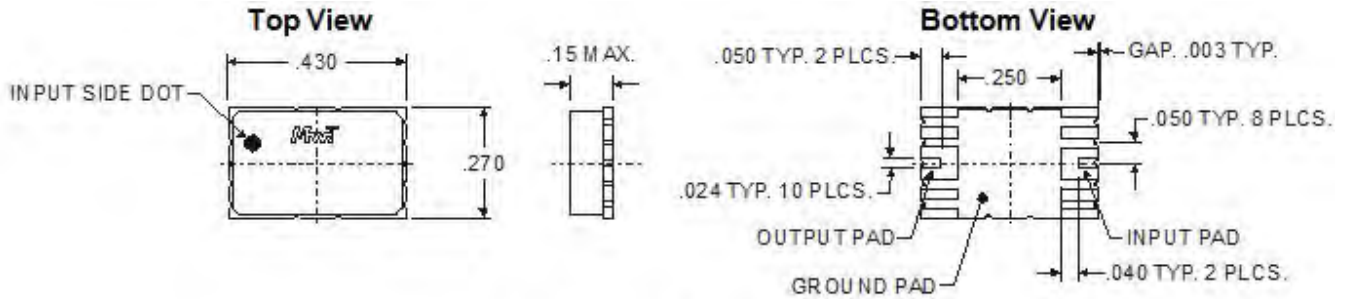

**All dimensions are in inches**

| Pin Designation (Top View) |          |        |            |
|----------------------------|----------|--------|------------|
| Pin 1 (DOT Top Left)       | GND      | Pin 10 | GND        |
| Pin 2                      | GND      | Pin 9  | GND        |
| Pin 3                      | RF In/Vg | Pin 8  | RF Out/Vdd |
| Pin 4                      | GND      | Pin 7  | GND        |
| Pin 5                      | GND      | Pin 6  | GND        |

## Contact Information

For additional information please visit [www.cmlmicro.com](http://www.cmlmicro.com) or contact a sales office.

| Europe  | America  | Asia   |
|---|--|--|
| <ul style="list-style-type: none"><li>• Maldon, UK</li><li>• Tel +44 (0) 1621 875500</li><li>• <a href="mailto:sales@cmlmicro.com">sales@cmlmicro.com</a></li></ul> | <ul style="list-style-type: none"><li>• Winston-Salem, NC</li><li>• Tel +1 336 744 5050</li><li>• <a href="mailto:us.sales@cmlmicro.com">us.sales@cmlmicro.com</a></li></ul> | <ul style="list-style-type: none"><li>• Singapore</li><li>• Tel +65 6288129</li><li>• <a href="mailto:sg.sales@cmlmicro.com">sg.sales@cmlmicro.com</a></li></ul> |

Although the information contained in this document is believed to be accurate, no responsibility is assumed by CML for its use. The product and product information is subject to change at any time without notice. CML has a policy of testing every product shipped using calibrated test equipment to ensure compliance with product specification.

© 2023 CML Microsystems Plc