

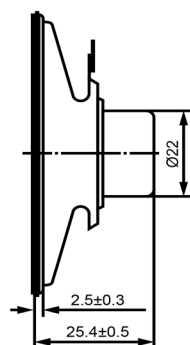

SIDE VIEW

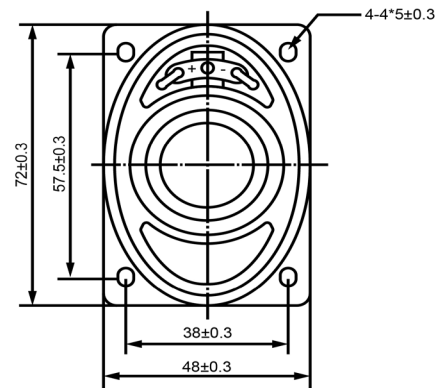

BOTTOM VIEW



Specifications			Notes	Revision History							
Description	Value	Unit		Version	Description	Date	Approved				
Shape	Rectangle		1) All dimensions are in mm unless otherwise noted 2) All parts meet RoHS	1	Released from Engineering	10/21/2013	J.S				
Resonant Frequency	340	(Hz)									
Frequency Range	340 ~ 18,000	(Hz)									
SPL @ 10cm	81	(dBA)									
Impedance	8	(Ohm)									
Cone Material	Paper										
Nominal Power	1	(W)									
Max Power	2	(W)									
Mount Type	Frame										
Operating Temperature	-25 ~ +55	°C									
Storage Temperature	-25 ~ +55	°C									
Weight	48	(g)									
						Drawn by	Date	Checked by	Date	Approved by	Date
						A.B.	10/21/2013	C.E.	10/21/2013	J.S	10/21/2013
			Dynamic Speaker			SP720308-1					