



NOTES1:

UL Standard

1. Rated voltage/current : 300V / 14.5A
2. Withstanding voltage : AC1600V/1Min.
3. Wire range : 28~14AWG
4. Ratings : Use group B 300V AC/DC
Use group D 300V AC/DC

NOTES2:

1. Dimension shall be interpreted per ASME Y14.5-2009
2. Pitch : 5.0mm, Poles : N=02~14P
3. Stripping length : 8~9mm
4. Operating temperature: -40°C~+105°C
5. Undimensioned tolerances:

Pitch range in mm		Nominal dimension range in mm					0.1/10													
TO	Over	TO	Over	TO	Over	TO														
6	6	10	10	30	30	60	60	100	100	150	150	±0.15	±0.20	±0.30	±0.30	±0.50	±0.70	±1.00	±1.30	±2'

6. RoHS Compliance

REVISION RECORD				
REV	ECN	DESCRIPTION	DRFT	DATE

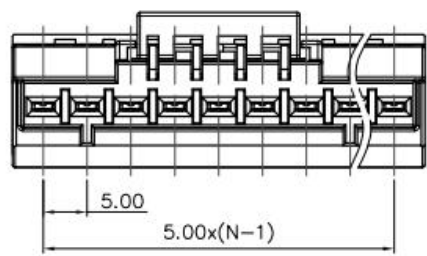
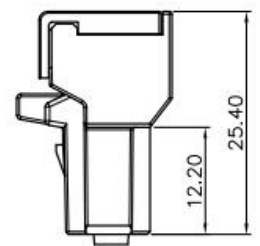
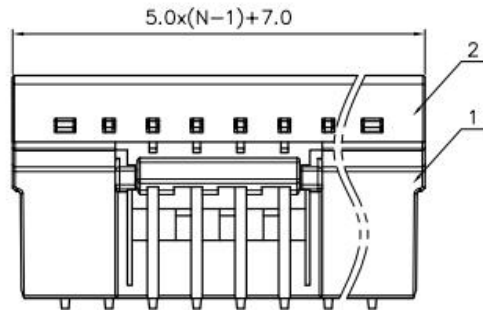
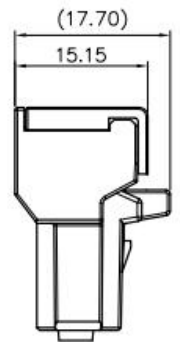
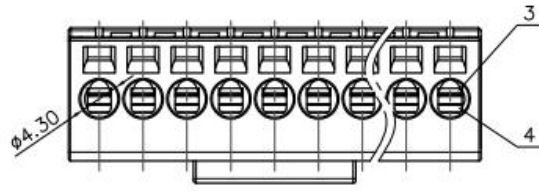

Ordering Information

JL9EDGK - 500 XX B 0 1

- Pitch 500=5.00PH
- No. of pins 2P-15P
- Housing Color
B=Black
G=Green
U=Blue
R=Red
W=White
Y=Yellow
D=Orange
E=Grey
- Packing
0=Pe bag
A=Tray
T=Tube

ITEM	NAME OF PART	MATERIAL	NOTES
4	Spring	Stainless Steel	
3	Clamp	Copper alloy	Sn/Au Plated
2	Cover	PA66+GF	UL94V-0
1	Housing	PA66+GF	UL94V-0

DRAW	LICHAO LIU	SCALE	FIT
CHECK	LICHAO LIU	UNIT	mm
APPROVE	G. Y. L	SIZE	A4
		SHEET	1/1
		PROJ.	◆

JILN 东莞市锦凌电子有限公司
DONGGUAN JINLING ELECTRONIC CO.,LTD

PART NO.	JL9EDGK-500XXB01
TITLE:	JL9EDGK-5.0母端/接线端子台

HSF RoHS COMPLIANT

REVISION RECORD				
REV	ECN	DESCRIPTION	DRFT	DATE

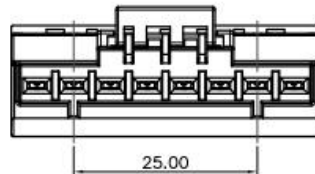
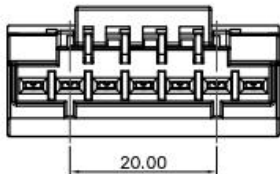
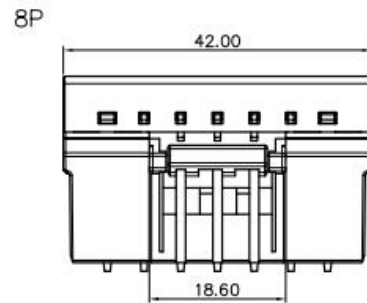
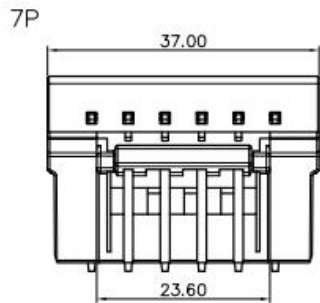
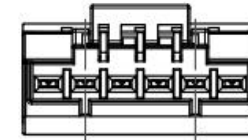
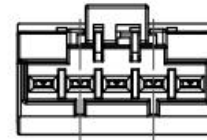
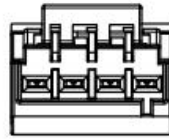
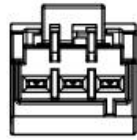
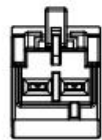
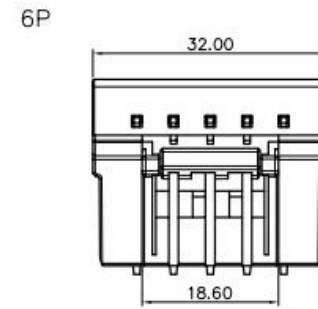
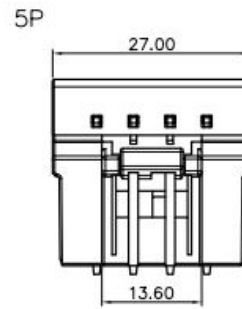
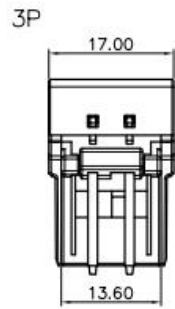
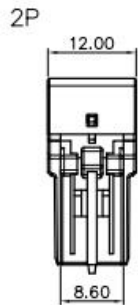

DRAW	Z. S. P	SCALE	FIT
		UNIT	mm
CHECK	LICHAO LIU	SIZE	A4
		SHEET	2/4
APPROVE	G. Y. L	PROJ.	◆

JILN 东莞市锦凌电子有限公司
DONGGUAN JINLING ELECTRONIC CO., LTD

PART NO.	JL9EDGK-500XB01
TITLE:	JL9EDGK-5.0母端/接线端子台

HSF RoHS  **US**

REVISION RECORD				
REV	ECN	DESCRIPTION	DRFT	DATE

9P

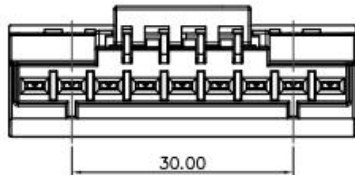
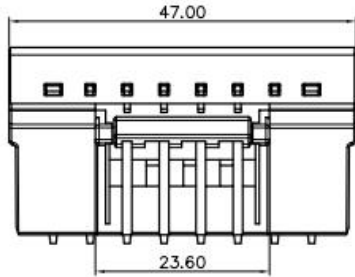

10P

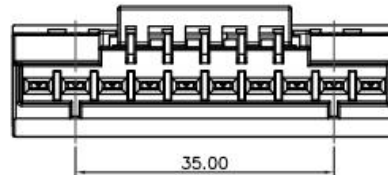
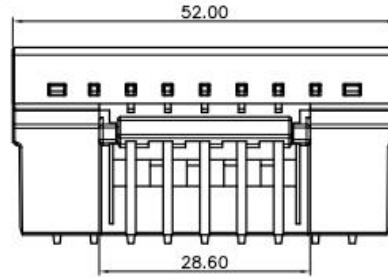

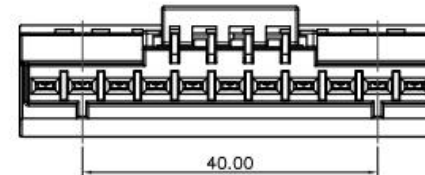
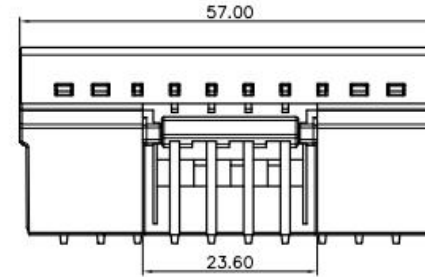

11P

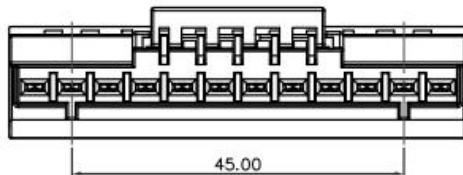
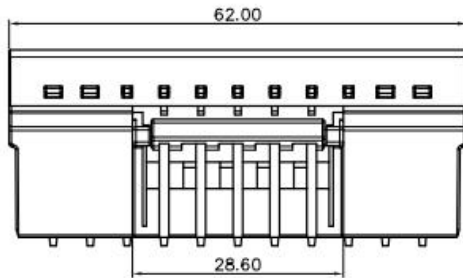

12P



DRAW	Z. S. P	SCALE	FIT	 东莞市锦凌电子有限公司 DONGGUAN JINLING ELECTRONIC CO., LTD	
CHECK	LICHAO LIU	UNIT	mm		
APPROVE	G. Y. L	SIZE	A4		
		SHEET	3/4		
		PROJ.		PART NO.	JL9EDGK-500XXB01
				TITLE:	JL9EDGK-5.0母端/接线端子台

HSF RoHS  us

REVISION RECORD				
REV	ECN	DESCRIPTION	DRFT	DATE

13P

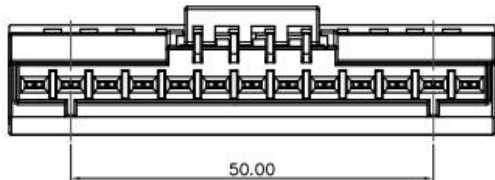
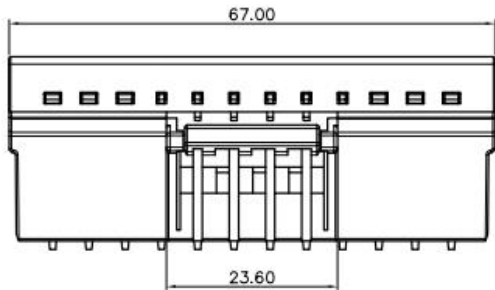

14P

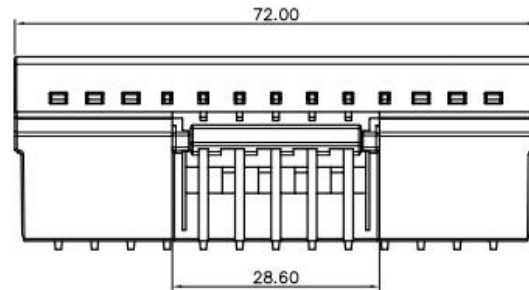

DRAW	Z. S. P	SCALE	FIT	 东莞市锦凌电子有限公司 DONGGUAN JINLING ELECTRONIC CO., LTD	
CHECK	LICHAO LIU	UNIT	mm		
APPROVE	G. Y. L	SIZE	A4	PART NO.	JL9EDGK-500XXB01
		SHEET	4/4	TITLE:	JL9EDGK-5.0母端/接线端子台
		PROJ.	