

Coaxial

Adapter SMA-F to SMA-MRP

SF-SMRP50+

50Ω

DC to 12 GHz

The Big Deal

- Wideband, DC-12 GHz
- Flat response
- Low insertion loss, 0.3 dB typ.
- Excellent VSWR, 1.2:1 typ.



CASE STYLE: DJ836

Product Overview

Mini-Circuits' SF-SMRP50+ is a 50Ω coaxial SMA-F to SMA-Male Reverse Polarity adapter supporting a wide range of applications from DC to 12 GHz. This model provides excellent VSWR, low insertion loss, and flat response versus frequency. The SF-SMRP50+ features rugged, passivated stainless steel construction and measures only 0.72" (l) x 0.36" (dia.).

Key Features

Feature	Advantages
Wideband, DC to 12 GHz	Wide frequency range provides application flexibility and makes this model ideal for broadband and multi-band use
Excellent VSWR, 1.2:1 typ.	Provides good matching for 50Ω systems and minimizes signal reflections across wide frequency range.
Low insertion loss, 0.3 dB typ.	Provides excellent signal power transmission from input to output.
Rugged, passivated stainless steel construction.	Stands up to wear and tear in demanding environments and provides excellent reliability.
Very wide operating temperature range, -55 to +100°C	Withstands extreme operating conditions and is suitable for use near high power componentry where heat rise is common.

Notes

- A. Performance and quality attributes and conditions not expressly stated in this specification document are intended to be excluded and do not form a part of this specification document.
B. Electrical specifications and performance data contained in this specification document are based on Mini-Circuit's applicable established test performance criteria and measurement instructions.
C. The parts covered by this specification document are subject to Mini-Circuits standard limited warranty and terms and conditions (collectively, "Standard Terms"); Purchasers of this part are entitled to the rights and benefits contained therein. For a full statement of the Standard Terms and the exclusive rights and remedies thereunder, please visit Mini-Circuits' website at www.minicircuits.com/MCLStore/terms.jsp



Coaxial Adapter SMA-F to SMA-MRP

SF-SMRP50+

50Ω DC to 12 GHz



Maximum Ratings

Operating Temperature -55°C to 100°C

Storage Temperature -55°C to 100°C

Permanent damage may occur if any of these limits are exceeded.

Features

- Flat response
- Excellent VSWR, 1.2:1 typ. up to 12 GHz
- Rugged stainless steel body

Applications

- Connector saver
- Cable extender

CASE STYLE: DJ836

Connectors	Model	
Conn1	Conn2	
SMA-F	SMA-MRP	SF-SMRP50+

+RoHS Compliant

The +Suffix identifies RoHS Compliance. See our web site for RoHS Compliance methodologies and qualifications

Outline Drawing

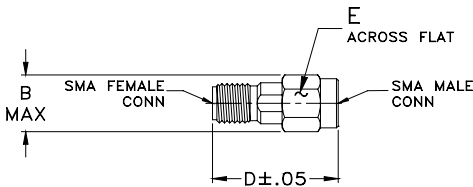

Outline Dimensions (inch/mm)

A	B	C	D	E	Wt.
--	.36	--	.72	.312	grams
--	9.14	--	18.29	7.92	3.2

Electrical Specifications at 25°C

Parameter	Condition (GHz)	Min.	Typ.	Max.	Units
Frequency Range		DC	-	12	GHz
Insertion Loss	DC-12	-	0.3	-	dB
VSWR	DC-5	-	1.05	1.2	:1
	5-12	-	1.2	1.4	

Typical Performance Data

Frequency (GHz)	Insertion Loss (dB)	VSWR (:1)	
		SMA-F	SMA-MRP
0.01	0.02	1.01	1.01
0.50	0.06	1.02	1.02
1.50	0.10	1.04	1.02
2.00	0.11	1.04	1.02
2.50	0.13	1.04	1.03
3.00	0.13	1.05	1.04
4.00	0.15	1.03	1.02
5.00	0.16	1.04	1.04
5.50	0.18	1.07	1.08
6.00	0.19	1.11	1.12
6.50	0.20	1.15	1.16
8.00	0.24	1.22	1.23
8.50	0.24	1.22	1.22
9.00	0.25	1.23	1.21
9.50	0.24	1.22	1.19
10.00	0.23	1.19	1.16
10.50	0.22	1.13	1.10
11.00	0.22	1.07	1.03
11.50	0.22	1.05	1.06
12.00	0.25	1.13	1.15

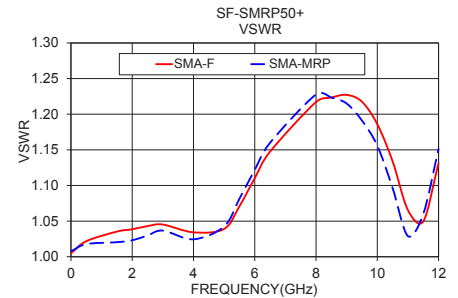
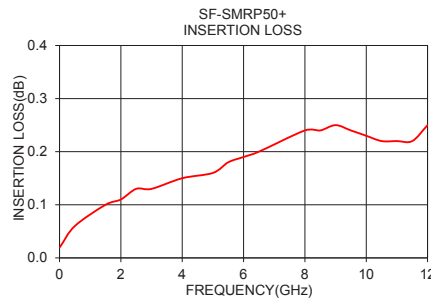

Notes

- Performance and quality attributes and conditions not expressly stated in this specification document are intended to be excluded and do not form a part of this specification document.
- Electrical specifications and performance data contained in this specification document are based on Mini-Circuit's applicable established test performance criteria and measurement instructions.
- The parts covered by this specification document are subject to Mini-Circuits standard limited warranty and terms and conditions (collectively, "Standard Terms"); Purchasers of this part are entitled to the rights and benefits contained therein. For a full statement of the Standard Terms and the exclusive rights and remedies thereunder, please visit Mini-Circuits' website at www.minicircuits.com/MCLStore/terms.jsp



Typical Performance Data

FREQ.	INSERTION LOSS	SMA-FEMALE RETURN LOSS	SMA-MALE REVERSE POLARITY RETURN LOSS
(GHz)	(dB)	(dB)	(dB)
0.01	0.02	51.60	48.08
0.05	0.01	51.90	48.68
0.10	0.02	47.77	47.75
0.20	0.03	43.86	44.56
0.30	0.05	42.25	42.76
0.40	0.06	40.38	41.36
0.50	0.06	39.33	41.11
0.60	0.07	38.57	40.23
0.70	0.08	38.02	40.31
0.80	0.08	37.80	40.01
0.90	0.08	37.19	39.56
1.00	0.09	36.94	40.11
1.10	0.09	36.25	39.83
1.20	0.09	36.23	40.17
1.30	0.10	35.83	40.06
1.40	0.10	35.56	40.18
1.50	0.10	35.21	39.90
1.60	0.10	35.20	39.65
1.70	0.11	34.97	39.83
1.80	0.11	34.73	39.67
1.90	0.11	34.61	38.62
2.00	0.11	34.46	38.85
2.50	0.13	33.53	36.64
3.00	0.13	33.11	34.88
3.50	0.14	33.62	35.12
4.00	0.15	35.47	38.34
4.50	0.16	37.54	41.47
5.00	0.16	34.36	33.62
5.50	0.18	29.31	28.15
6.00	0.19	25.64	24.81
6.50	0.20	23.26	22.61
7.00	0.22	21.75	21.08
7.50	0.23	20.78	20.26
8.00	0.24	20.18	19.81
8.50	0.24	19.96	19.96
9.00	0.25	19.83	20.26
9.50	0.24	20.17	21.19
10.00	0.23	21.40	22.82
10.50	0.22	24.05	26.74
11.00	0.22	29.98	36.91
11.50	0.22	32.35	30.74
12.00	0.25	24.20	23.06
12.50	0.28	20.18	19.59
13.00	0.31	18.39	17.94
13.50	0.32	18.10	17.74
14.00	0.31	19.62	19.44
14.50	0.28	23.28	23.40
15.00	0.26	33.10	36.64
15.50	0.27	25.11	24.16
16.00	0.32	18.94	18.35
16.50	0.39	15.76	14.96
17.00	0.46	14.04	13.38
17.40	0.51	13.40	12.83
17.60	0.52	13.30	12.65
17.80	0.53	13.28	12.67
18.00	0.53	13.32	12.82
18.50	0.51	14.11	13.35
19.00	0.47	15.21	14.46
19.50	0.43	16.69	16.09
20.00	0.39	18.66	19.00

Typical Performance Curves

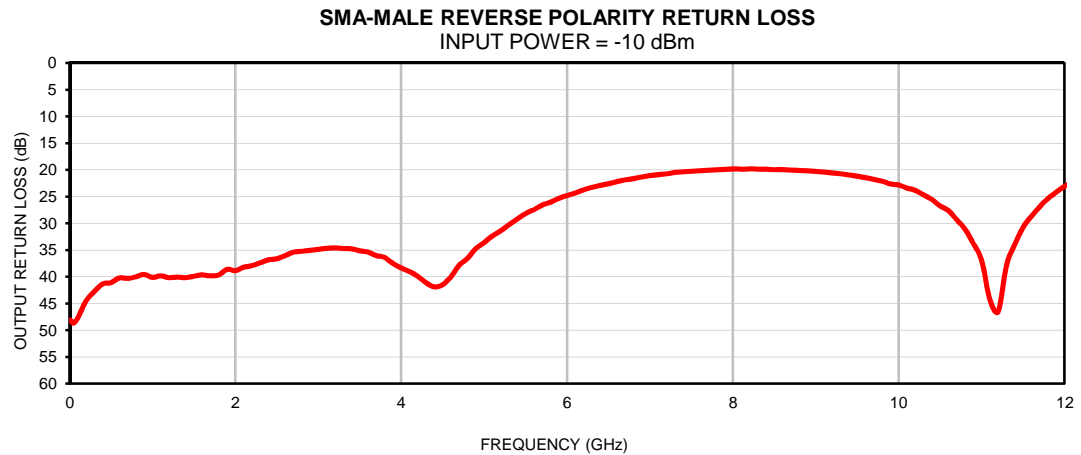
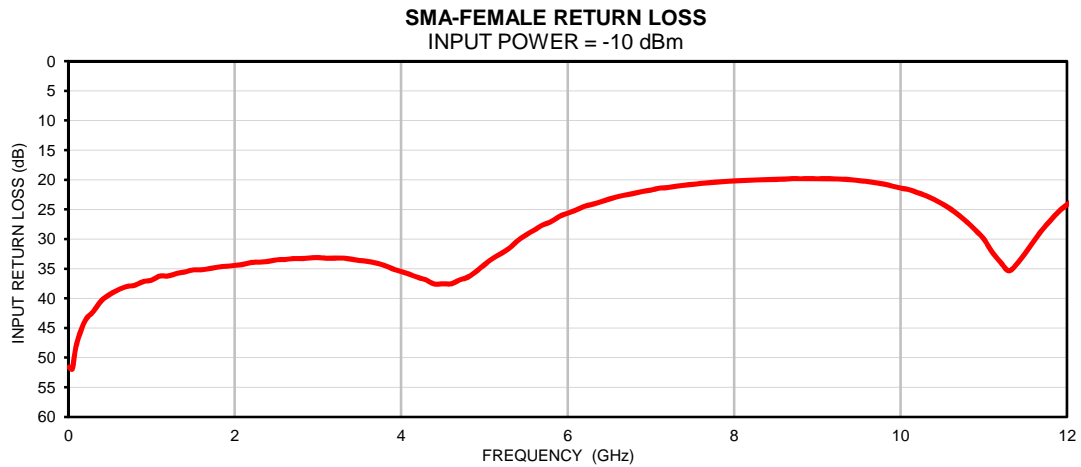
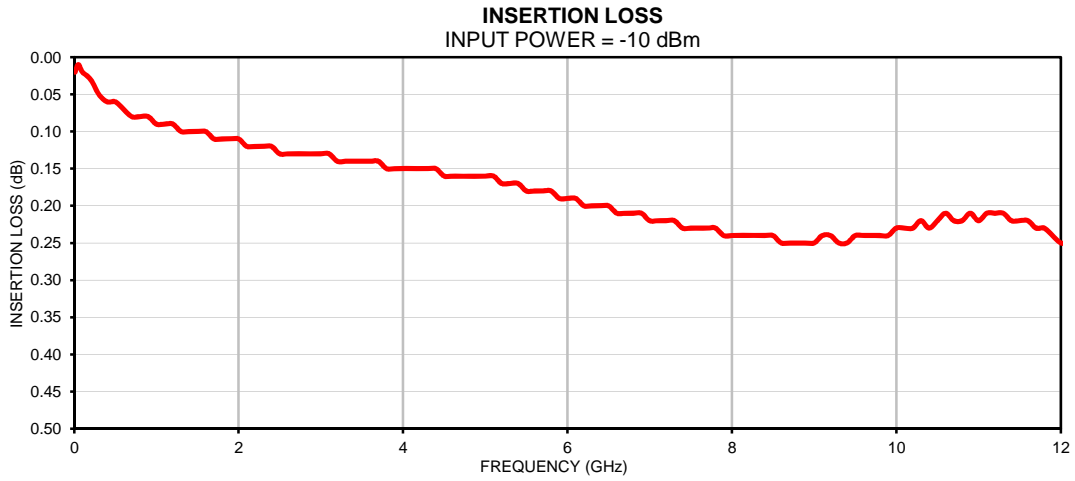

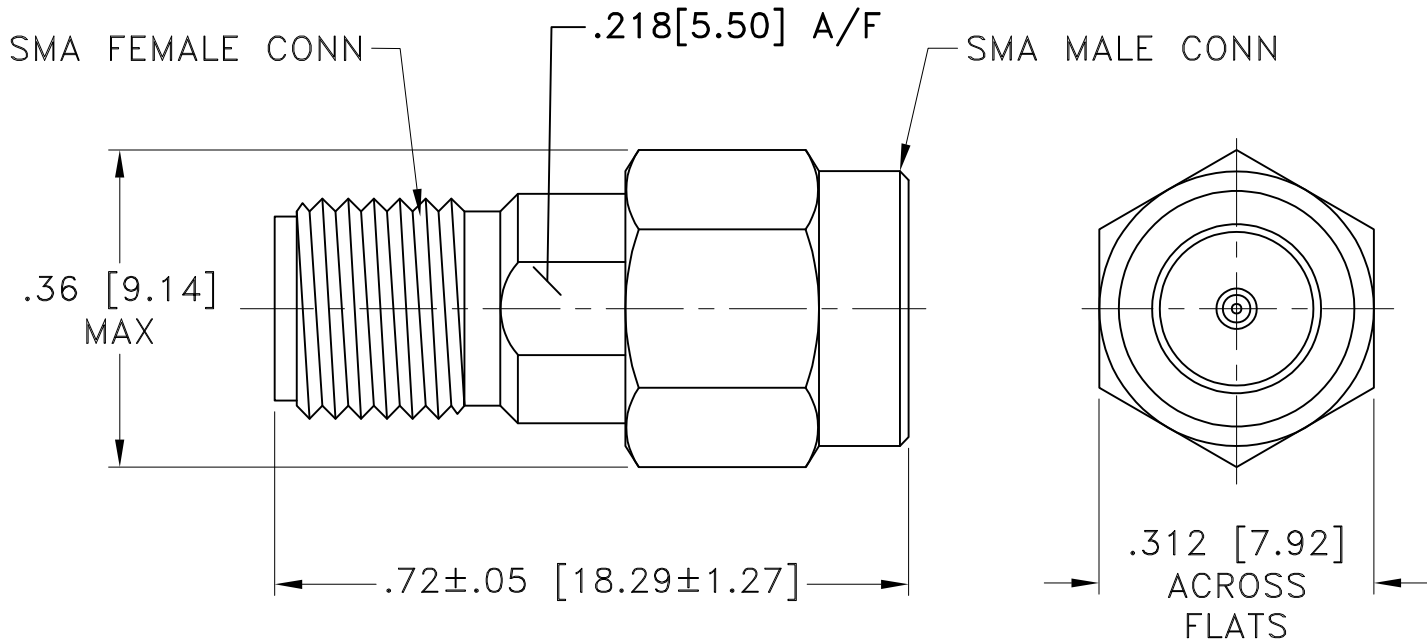

Weight: 3.2 grams

Dimensions are in inches [mm]. Tolerances: 2 Pl. ± .03; 3 Pl. ± .015 Inches

Notes:

1. Case material: Stainless steel.
2. Case Finish: Passivation or Gold Plating. (See individual model datasheet).
3. For polarity of connector refer individual model data sheet.

Mini-Circuits®
ISO 9001 ISO 14001 CERTIFIED

ALL NEW
minicircuits.com

P.O. Box 350166, Brooklyn, New York 11235-0003 (718) 934-4500 Fax (718) 332-4661 For detailed performance specs & shopping online see Mini-Circuits web site



The Design Engineers Search Engine Provides ACTUAL Data Instantly From MINI-CIRCUITS At: www.minicircuits.com

RF/IF MICROWAVE COMPONENTS



All Mini-Circuits products are manufactured under exacting quality assurance and control standards, and are capable of meeting published specifications after being subjected to any or all of the following physical and environmental test.

Specification	Test/Inspection Condition	Reference/Spec
Operating Temperature	-55° to 100°C Ambient Environment	Individual Model Data Sheet
Storage Temperature	-55° to 100° C Ambient Environment	Individual Model Data Sheet
Barometric Pressure	100,000 Feet	MIL-STD-202, Method 105, Condition D
Humidity	90% RH, 65°C Units may require bake-out after humidity to restore full performance.	MIL-STD-202, Method 103
Thermal Shock	-65° to 125°C, 5 cycles	MIL-STD-202, Method 107, Condition B
Vibration (High Frequency)	20g peak, 10-2000 Hz, 12 times in each of three perpendicular directions (total 36)	MIL-STD-202, Method 204, Condition D
Mechanical Shock	100g, 6ms sawtooth, 3 shocks each direction 3 axes (total 18)	MIL-STD-202, Method 213, Condition I