

GENERAL DESCRIPTION

The SGM8910 is a high performance 4Vrms stereo audio line driver with click-pop noise cancellation. The device is ideal for single supply applications. The SGM8910 can drive 32Ω impedance headphone directly, so it can be used as the high performance driver of line out and headphone in different applications. Capless design can eliminate output DC-blocking capacitors for less-component count and low-cost.

The SGM8910 is capable of driving 4Vrms into a 600Ω load when V_{DD} is 10V or 20mW into a 32Ω headphone when V_{DD} is 3.3V. An integrated charge pump generates a negative power rail that provides a clean, pop-free ground offset.

For some special applications where AC coupling output is necessary, the SGM8910 provides MUTEOUT driver to drive external click-pop noise cancellation circuit during power-on and power-off.

The SGM8910 will be in mute status during power-on blanking time. External mute control signal can take over the mute status before power-on blanking time is over. The SGM8910 can eliminate power-up click-pop noise perfectly. Using under-voltage protection (UVP), the SGM8910 will suppress the turn-off click-pop noise.

The SGM8910 is available in Green TSSOP-20 and TQFN-4×4-20L packages. It operates over an ambient temperature range of -40°C to +85°C.

FEATURES

- **Supply Voltage: 2.8V to 12V**
- **Capless Structure to Eliminate Pop-Clicks and Output DC-Blocking Capacitors**
- **Low Noise, Low THD and Low Crosstalk:**
 - ◆ **Typical $V_N = 6\mu V_{RMS}$ from 22Hz to 22kHz at Gain = -1**
 - ◆ **THD+N = 0.0008% for 10kΩ Load and Gain = -1 at 1kHz**
 - ◆ **Crosstalk = -89dB at 1kHz**
- **4Vrms Output Voltage into 600Ω Load for 10V V_{DD}**
- **1Vrms Output Voltage into 600Ω Load for 3.3V V_{DD}**
- **Supports to Drive 32Ω to 600Ω Headphone:**
 - THD+N = 0.006% for 32Ω Headphone and $P_O = 20mW$ at $V_{DD} = 3.3V$**
- **Single-Ended Output**
- **Differential or Single-Ended Input**
- **UVP Function to Cancel Turn-Off Click-Pop Noise**
- **Adjustable Power-On Blanking Time to Eliminate Turn-On Click-Pop Noise**
- **Short-Circuit and Thermal Protection for Audio Driver**
- **Negative LDO with Output Auto-Discharge Function in Disable Status**
- **1.8V Logical Control for EN and \overline{MUTE}**
- **-40°C to +85°C Operating Temperature Range**
- **Available in Green TSSOP-20 and TQFN-4×4-20L Packages**

APPLICATIONS

LCD TVs
Mini/Micro Combo Systems
Soundcards
DVD Players

4Vrms High Performance Audio Line and Headphone Driver with Click-Pop Noise Cancellation

SGM8910

PACKAGE/ORDERING INFORMATION

MODEL	PACKAGE DESCRIPTION	SPECIFIED TEMPERATURE RANGE	ORDERING NUMBER	PACKAGE MARKING	PACKING OPTION
SGM8910	TSSOP-20	-40°C to +85°C	SGM8910YTS20G/TR	SGM8910YTS20 XXXXX	Tape and Reel, 4000
	TQFN-4x4-20L	-40°C to +85°C	SGM8910YTQI20G/TR	SGM8910 YTQI20 XXXXX	Tape and Reel, 3000

NOTE: XXXXXX = Date Code and Vendor Code.

Green (RoHS & HSF): SG Micro Corp defines "Green" to mean Pb-Free (RoHS compatible) and free of halogen substances. If you have additional comments or questions, please contact your SGMICRO representative directly.

ABSOLUTE MAXIMUM RATINGS

Supply Voltage Range -0.3V to 13.2V
 Input Voltage Range $V_{SS} - 0.3V$ to $V_{DD} + 0.3V$
 \overline{MUTE} , EN and UVP to GND -0.3V to 6V
 Junction Temperature +150°C
 Storage Temperature Range -65°C to +150°C
 Lead Temperature (Soldering, 10s) +260°C
 ESD Susceptibility
 HBM 4000V
 MM 250V
 CDM 1000V

RECOMMENDED OPERATING CONDITIONS

Supply Voltage Range 2.8V to 12V
 Operating Temperature Range -40°C to +85°C

OVERSTRESS CAUTION

Stresses beyond those listed in Absolute Maximum Ratings may cause permanent damage to the device. Exposure to absolute maximum rating conditions for extended periods may affect reliability. Functional operation of the device at any conditions beyond those indicated in the Recommended Operating Conditions section is not implied.

ESD SENSITIVITY CAUTION

This integrated circuit can be damaged if ESD protections are not considered carefully. SGMICRO recommends that all integrated circuits be handled with appropriate precautions. Failure to observe proper handling and installation procedures can cause damage. ESD damage can range from subtle performance degradation to complete device failure. Precision integrated circuits may be more susceptible to damage because even small parametric changes could cause the device not to meet the published specifications.

DISCLAIMER

SG Micro Corp reserves the right to make any change in circuit design, or specifications without prior notice.

4Vrms High Performance Audio Line and Headphone Driver with Click-Pop Noise Cancellation

SGM8910

PIN CONFIGURATIONS

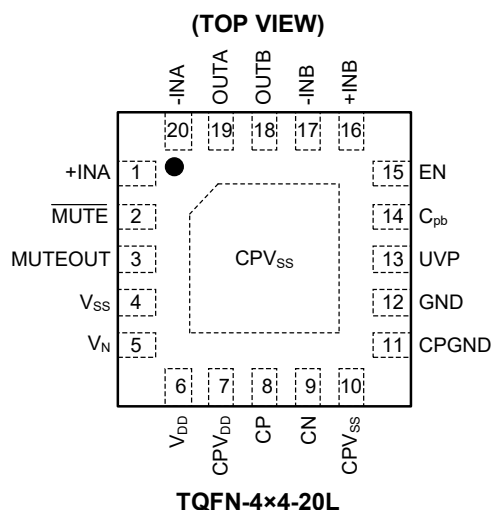
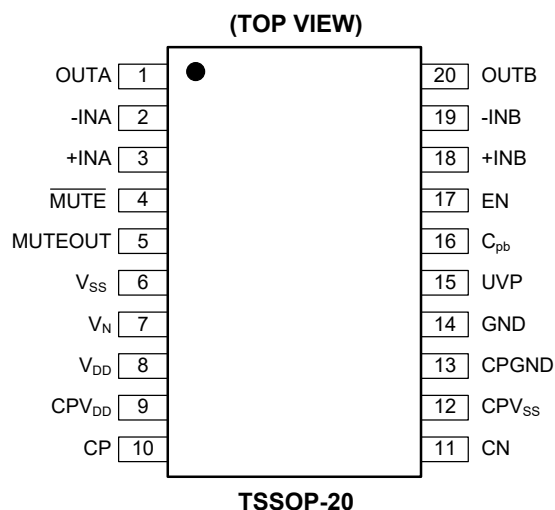

PIN DESCRIPTION

PIN		NAME	FUNCTION
TSSOP-20	TQFN-4x4-20L		
1	19	OUTA	Output of driver A.
2	20	-INA	Negative input of driver A.
3	1	+INA	Positive input of driver A.
4	2	MUTE	Mute control input, active low. When $\overline{\text{MUTE}}$ = "Low", chip enters into mute status; when $\overline{\text{MUTE}}$ = "High", chip works normally. There is a 5MΩ pull-low resistor at MUTE pin.
5	3	MUTEOUT	Open drain output of mute. When the SGM8910 is in mute status, MUTEOUT will be in high-impedance state; when the SGM8910 is not in mute status, MUTEOUT will be in low logical output to drive external mute circuit.
6	4	V _{SS}	Negative power supply of drivers.
7	5	V _N	Output of negative low dropout regulator.
8	6	V _{DD}	Positive supply voltage of drivers. When V _{DD} under-voltage event happens, chip will enter into mute status.
9	7	CPV _{DD}	Power supply of negative charge pump.
10	8	CP	Positive terminal for charge pump flying capacitor.
11	9	CN	Negative terminal for charge pump flying capacitor.
12	10	CPV _{SS}	Output of negative charge pump.
13	11	CPGND	Ground of charge pump.
14	12	GND	Ground.
15	13	UVP	Under-voltage protection input. When UVP event happens, chip will be in mute status.
16	14	C _{pb}	Power-on blanking time adjusting. Connect a capacitor from C _{pb} pin to GND to program the power-on blanking time. Chip is in mute status during power-on blanking time.
17	15	EN	Enable control input of chip. EN = "High" to enable chip, the SGM8910 is in active status; EN = "Low" to disable chip, the SGM8910 is in shutdown status.
18	16	+INB	Positive input of driver B.
19	17	-INB	Negative input of driver B.
20	18	OUTB	Output of driver B.
-	Thermal Pad	CPV _{SS}	Output of negative charge pump.

4Vrms High Performance Audio Line and Headphone Driver with Click-Pop Noise Cancellation

SGM8910

ELECTRICAL CHARACTERISTICS

(At $T_A = +25^\circ\text{C}$ and $V_{DD} = 2.8\text{V}$ to 12V , unless otherwise noted.)

PARAMETER	CONDITIONS	MIN	TYP	MAX	UNITS
Recommended Operating Conditions					
Supply Voltage (V_{DD})		2.8		12	V
R_{LOAD}		32			Ω
\overline{MUTE} , EN Low-Level Input Voltage (V_{IL})				0.6	V
\overline{MUTE} , EN High-Level Input Voltage (V_{IH})		1.4			V
Electrical Characteristics ($V_{DD} = 2.8\text{V}$ to 12V, $R_{LOAD} = 10\text{k}\Omega$, $C_{FLY} = 1\mu\text{F}$)					
Output Offset Voltage ($ V_{OS} $)	Input AC-coupled		100	550	μV
Power Supply Rejection Ratio (PSRR)			1	5	$\mu\text{V/V}$
High-Level Output Voltage (V_{OH})	$V_{DD} = 3.3\text{V}$	3.27	3.29		V
	$V_{DD} = 12\text{V}$	11.9	11.95		V
Low-Level Output Voltage (V_{OL})	$V_{DD} = 3.3\text{V}$		-1.75	-1.6	V
	$V_{DD} = 12\text{V}$		-10.65	-10.3	V
External Under-Voltage Detection (V_{UVP})		1.12	1.21	1.29	V
Charge Pump Switching Frequency (f_{CP})		315	495	700	kHz
High-Level Input Current, \overline{MUTE} ($ I_{IH} $)	$V_{DD} = 3.3\text{V}$, $V_{IH} = V_{DD}$			1	μA
Low-Level Input Current, \overline{MUTE} ($ I_{IL} $)	$V_{DD} = 3.3\text{V}$, $V_{IL} = 0\text{V}$			1	μA
High-Level Input Current, EN ($ I_{IH} $)	$V_{DD} = 3.3\text{V}$, $V_{IH} = V_{DD}$			1	μA
Low-Level Input Current, EN ($ I_{IL} $)	$V_{DD} = 3.3\text{V}$, $V_{IL} = 0\text{V}$			1	μA
Supply Current (I_{VDD})	$\overline{MUTE} = 3.3\text{V}$, EN = 3.3V, no load		17	21	mA
	$\overline{MUTE} = 0\text{V}$, EN = 3.3V, no load		5.2	6.5	mA
	$\overline{MUTE} = 3.3\text{V}$, EN = 0V, no load		470		μA
Thermal Shutdown (T_{TSD})			155		$^\circ\text{C}$
Thermal Shutdown Hysteresis (T_{HYS})			25		$^\circ\text{C}$
Operating Characteristics (Gain = -1, $R_{IN} = 10\text{k}\Omega$, $R_F = 10\text{k}\Omega$, $C_{FLY} = 1\mu\text{F}$)					
Output Voltage, Outputs in Phase (V_O)	$V_{DD} = 3.3\text{V}$, $f = 1\text{kHz}$, $R_{LOAD} = 10\text{k}\Omega$, THD+N = 1%		1.2		Vrms
	$V_{DD} = 12\text{V}$, $f = 1\text{kHz}$, $R_{LOAD} = 10\text{k}\Omega$, THD+N = 1%		7.2		Vrms
Total Harmonic Distortion Plus Noise (THD+N)	$V_{DD} = 3.3\text{V}$, $f = 1\text{kHz}$, $R_{LOAD} = 10\text{k}\Omega$, $V_O = 1\text{Vrms}$, BW = 22Hz to 22kHz		0.0008		%
			-102		dB
	$V_{DD} = 5\text{V}$, $f = 1\text{kHz}$, $R_{LOAD} = 10\text{k}\Omega$, $V_O = 2\text{Vrms}$, BW = 22Hz to 22kHz		0.0005		%
			-106		dB
Output Power (P_O)	$V_{DD} = 12\text{V}$, $f = 1\text{kHz}$, $R_{LOAD} = 10\text{k}\Omega$, $V_O = 4\text{Vrms}$, BW = 22Hz to 22kHz		0.0003		%
			-110		dB
	$V_{DD} = 3.3\text{V}$, $f = 1\text{kHz}$, $R_{LOAD} = 32\Omega$, THD+N < 0.01%, BW = 22Hz to 22kHz		20		mW
Dynamic Range (DNR)	$V_{DD} = 5\text{V}$, $f = 1\text{kHz}$, $R_{LOAD} = 32\Omega$, THD+N < 0.01%, BW = 22Hz to 22kHz		50		mW
	$V_{DD} = 12\text{V}$, $f = 1\text{kHz}$, $R_{LOAD} = 32\Omega$, THD+N < 0.01%, BW = 22Hz to 22kHz		80		mW
	$V_{DD} = 3.3\text{V}$, $R_{LOAD} = 10\text{k}\Omega$, $V_O = 1\text{Vrms}$, A-weighted, AES17 filter		104		dB
Dynamic Range (DNR)	$V_{DD} = 5\text{V}$, $R_{LOAD} = 10\text{k}\Omega$, $V_O = 2\text{Vrms}$, A-weighted, AES17 filter		110		dB
	$V_{DD} = 12\text{V}$, $R_{LOAD} = 10\text{k}\Omega$, $V_O = 4\text{Vrms}$, A-weighted, AES17 filter		116		dB

SGM8910 4Vrms High Performance Audio Line and Headphone Driver with Click-Pop Noise Cancellation

ELECTRICAL CHARACTERISTICS (continued)

(At $T_A = +25^\circ\text{C}$ and $V_{DD} = 2.8\text{V}$ to 12V , unless otherwise noted.)

PARAMETER	CONDITIONS	MIN	TYP	MAX	UNITS
Signal-to-Noise Ratio (SNR)	$V_{DD} = 3.3\text{V}$, $f = 1\text{kHz}$, $R_{LOAD} = 10\text{k}\Omega$, $V_O = 1\text{V}_{RMS}$, BW = 22Hz to 22kHz, A-weighted, AES17 filter		104		dB
	$V_{DD} = 5\text{V}$, $f = 1\text{kHz}$, $R_{LOAD} = 10\text{k}\Omega$, $V_O = 2\text{V}_{RMS}$, BW = 22Hz to 22kHz, A-weighted, AES17 filter		110		dB
	$V_{DD} = 12\text{V}$, $f = 1\text{kHz}$, $R_{LOAD} = 10\text{k}\Omega$, $V_O = 4\text{V}_{RMS}$, BW = 22Hz to 22kHz, A-weighted, AES17 filter		116		dB
Noise Voltage (V_N)	$V_{DD} = 3.3\text{V}$ to 12V , A-weighted, AES17 filter		6		μV_{RMS}
Output Impedance when Muted (Z_O)	$V_{DD} = 3.3\text{V}$ to 12V		150		Ω
Input-to-Output Attenuation when Muted	$\overline{\text{MUTE}} = \text{GND}$		45		dB
Slew Rate	$V_{DD} = 3.3\text{V}$, $f = 1\text{kHz}$, $R_{LOAD} = 10\text{k}\Omega$, $V_O = 2\text{V}_{PP}$		15		$\text{V}/\mu\text{s}$
	$V_{DD} = 3.3\text{V}$, $f = 1\text{kHz}$, $R_{LOAD} = 32\Omega$, $V_O = 1\text{V}_{PP}$		5		$\text{V}/\mu\text{s}$
	$V_{DD} = 5\text{V}$, $f = 1\text{kHz}$, $R_{LOAD} = 10\text{k}\Omega$, $V_O = 4\text{V}_{PP}$		18		$\text{V}/\mu\text{s}$
	$V_{DD} = 5\text{V}$, $f = 1\text{kHz}$, $R_{LOAD} = 32\Omega$, $V_O = 2\text{V}_{PP}$		9		$\text{V}/\mu\text{s}$
	$V_{DD} = 12\text{V}$, $f = 1\text{kHz}$, $R_{LOAD} = 10\text{k}\Omega$, $V_O = 4\text{V}_{PP}$		20		$\text{V}/\mu\text{s}$
	$V_{DD} = 12\text{V}$, $f = 1\text{kHz}$, $R_{LOAD} = 32\Omega$, $V_O = 2\text{V}_{PP}$		9		$\text{V}/\mu\text{s}$
Unity-Gain Bandwidth (GBP)	$V_{DD} = 3.3\text{V}$ to 12V		60		MHz
Crosstalk-Line L-R and R-L	$V_{DD} = 3.3\text{V}$, $f = 1\text{kHz}$, $R_{LOAD} = 10\text{k}\Omega$, $V_O = 1\text{V}_{RMS}$, BW = 22Hz to 22kHz		-120		dB
	$V_{DD} = 3.3\text{V}$, $f = 1\text{kHz}$, $R_{LOAD} = 32\Omega$, $P_O = 10\text{mW}$, BW = 22Hz to 22kHz		-89		dB
	$V_{DD} = 5\text{V}$, $f = 1\text{kHz}$, $R_{LOAD} = 10\text{k}\Omega$, $V_O = 2\text{V}_{RMS}$, BW = 22Hz to 22kHz		-126		dB
	$V_{DD} = 5\text{V}$, $f = 1\text{kHz}$, $R_{LOAD} = 32\Omega$, $P_O = 20\text{mW}$, BW = 22Hz to 22kHz		-89		dB
	$V_{DD} = 12\text{V}$, $f = 1\text{kHz}$, $R_{LOAD} = 10\text{k}\Omega$, $V_O = 4\text{V}_{RMS}$, BW = 22Hz to 22kHz		-132		dB
	$V_{DD} = 12\text{V}$, $f = 1\text{kHz}$, $R_{LOAD} = 32\Omega$, $P_O = 20\text{mW}$, BW = 22Hz to 22kHz		-89		dB
Current Limit (I_{LIM})	$V_{DD} = 3.3\text{V}$ to 12V		65		mA

SGM8910 4Vrms High Performance Audio Line and Headphone Driver with Click-Pop Noise Cancellation

TYPICAL PERFORMANCE CHARACTERISTICS

At $T_A = +25^\circ\text{C}$, Gain = -1, $R_{IN} = 10\text{k}\Omega$, $R_F = 10\text{k}\Omega$, $C_{FLY} = 1\mu\text{F}$ and BW = 22Hz to 22kHz, unless otherwise noted.

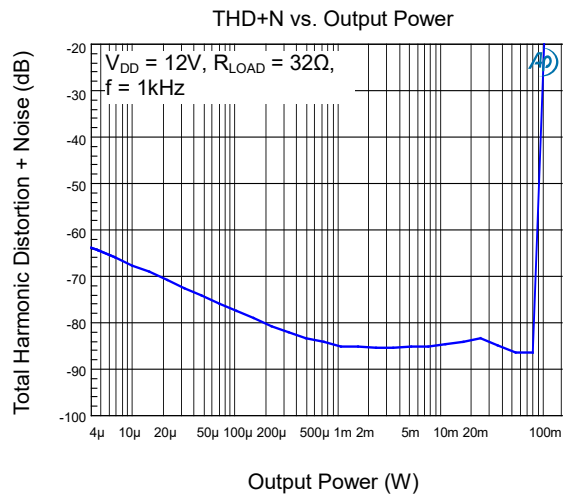
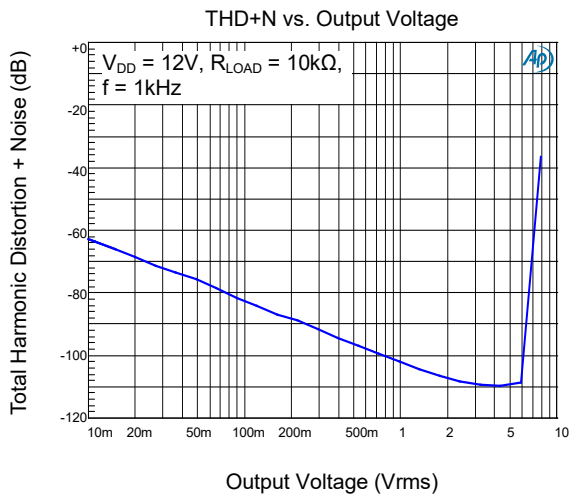
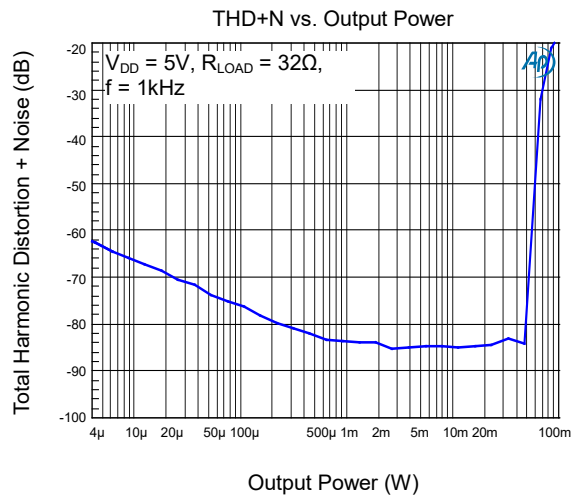
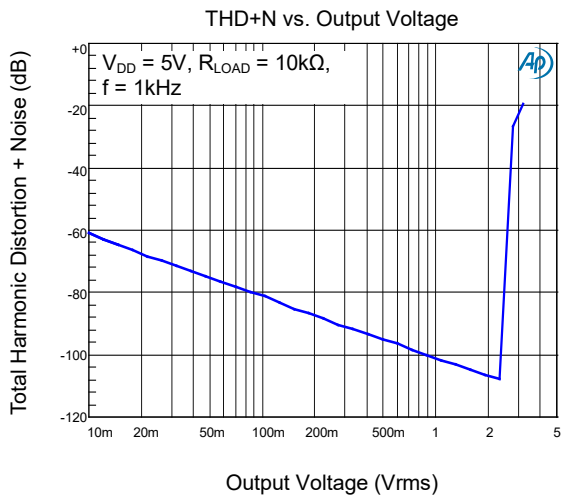
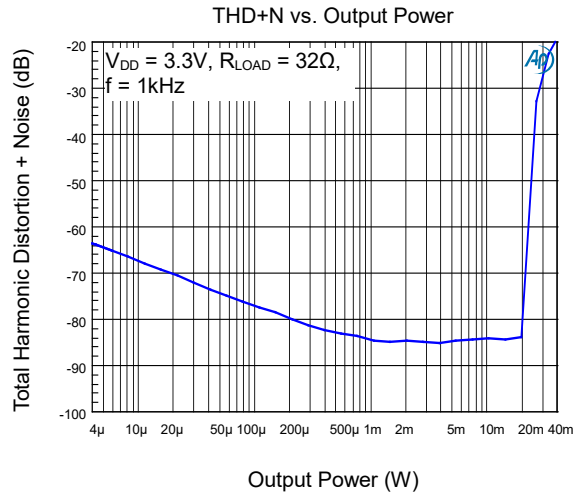
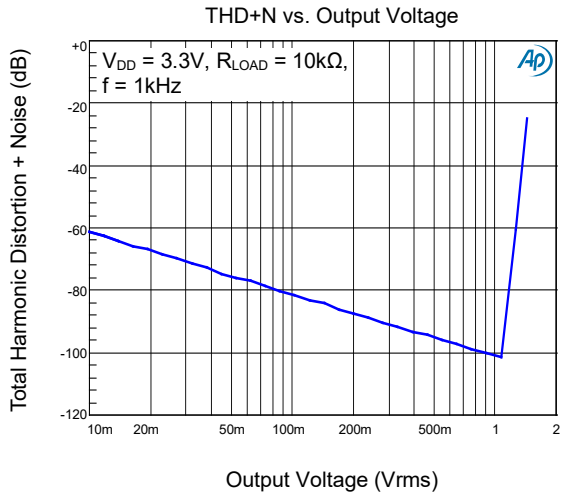

SGM8910 4Vrms High Performance Audio Line and Headphone Driver with Click-Pop Noise Cancellation

TYPICAL PERFORMANCE CHARACTERISTICS (continued)

At $T_A = +25^\circ\text{C}$, Gain = -1, $R_{IN} = 10\text{k}\Omega$, $R_F = 10\text{k}\Omega$, $C_{FLY} = 1\mu\text{F}$ and BW = 22Hz to 22kHz, unless otherwise noted.

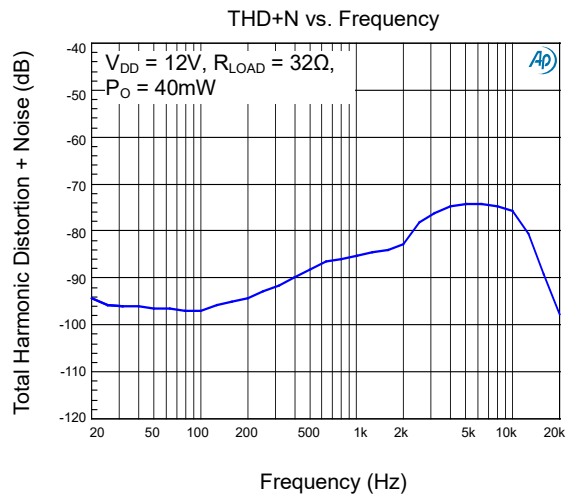
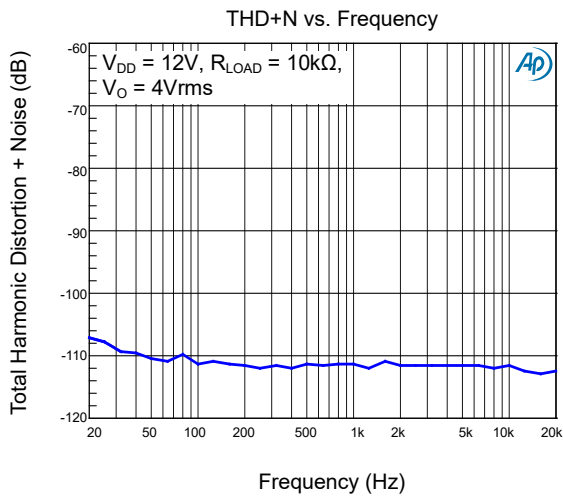
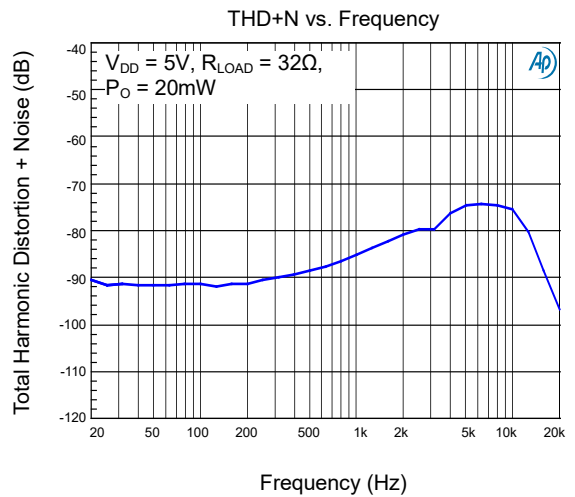
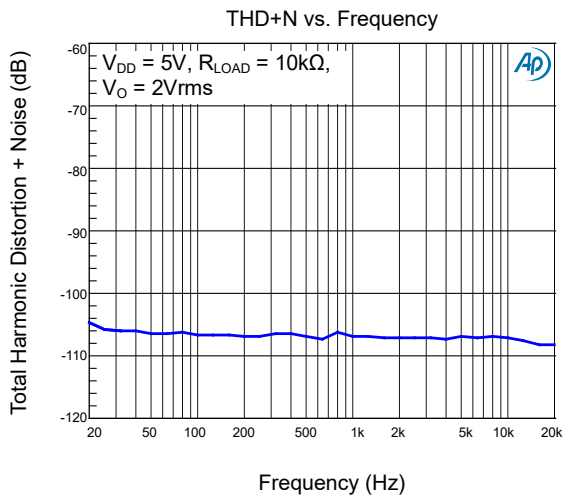
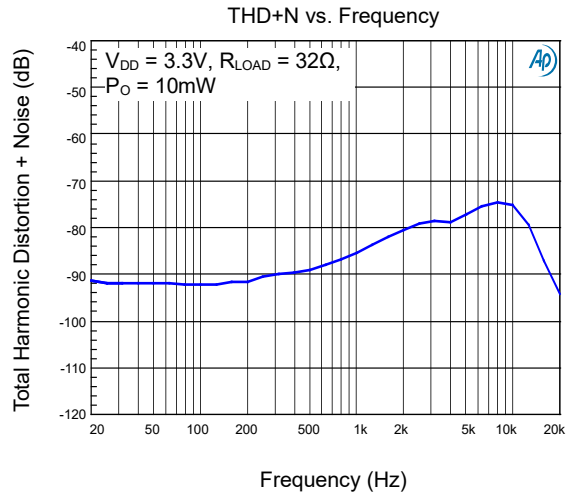
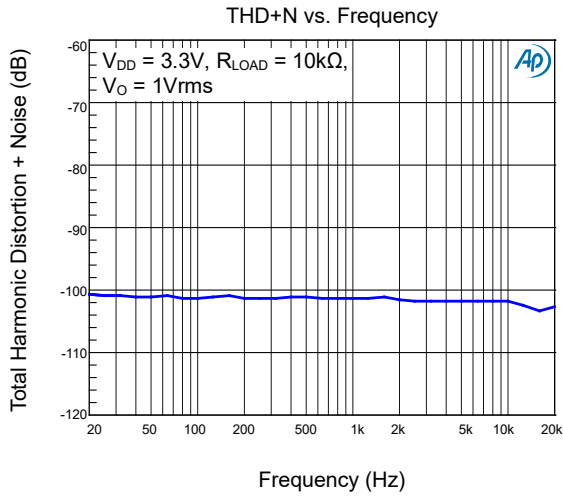

SGM8910 4Vrms High Performance Audio Line and Headphone Driver with Click-Pop Noise Cancellation

TYPICAL PERFORMANCE CHARACTERISTICS (continued)

At $T_A = +25^\circ\text{C}$, Gain = -1, $R_{IN} = 10\text{k}\Omega$, $R_F = 10\text{k}\Omega$, $C_{FLY} = 1\mu\text{F}$ and BW = 22Hz to 22kHz, unless otherwise noted.

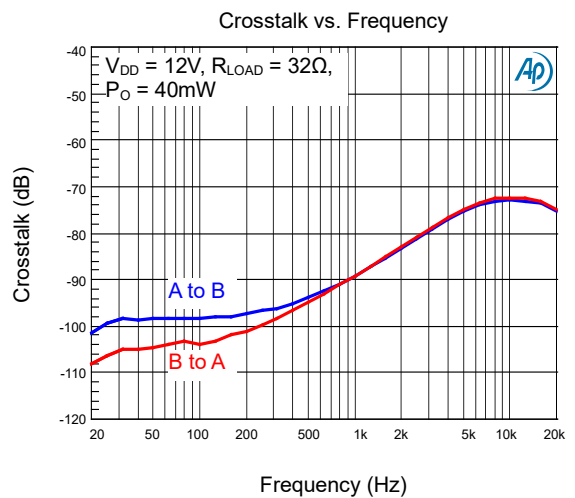
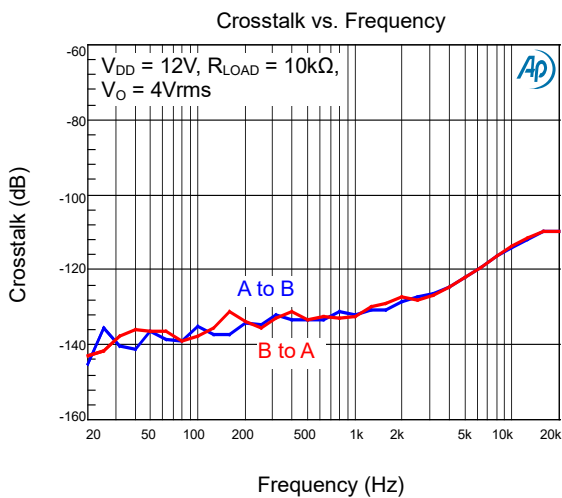
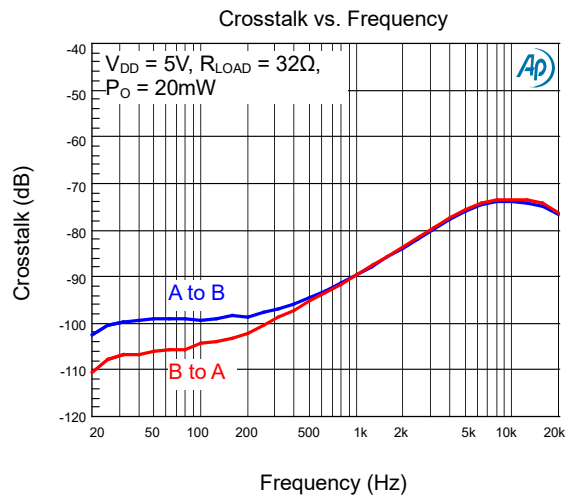
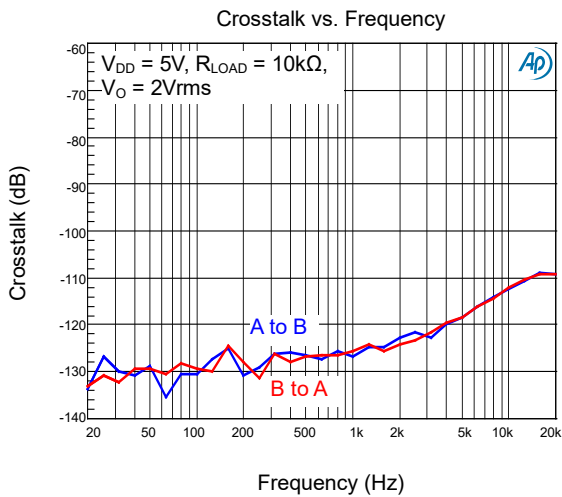
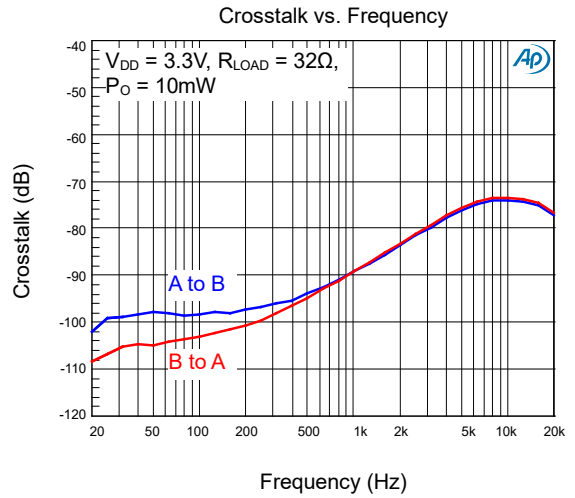
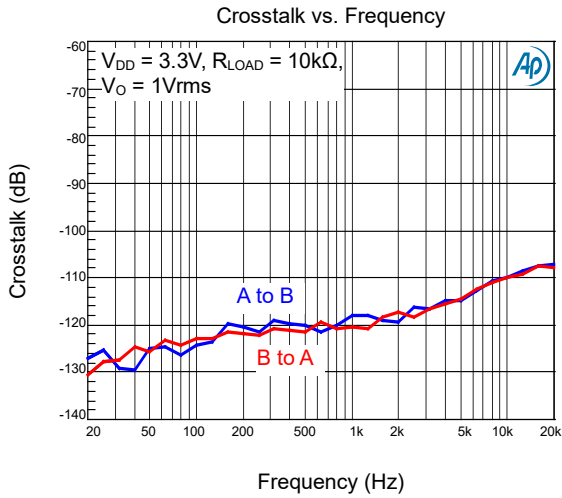

SGM8910 4Vrms High Performance Audio Line and Headphone Driver with Click-Pop Noise Cancellation

TYPICAL APPLICATION

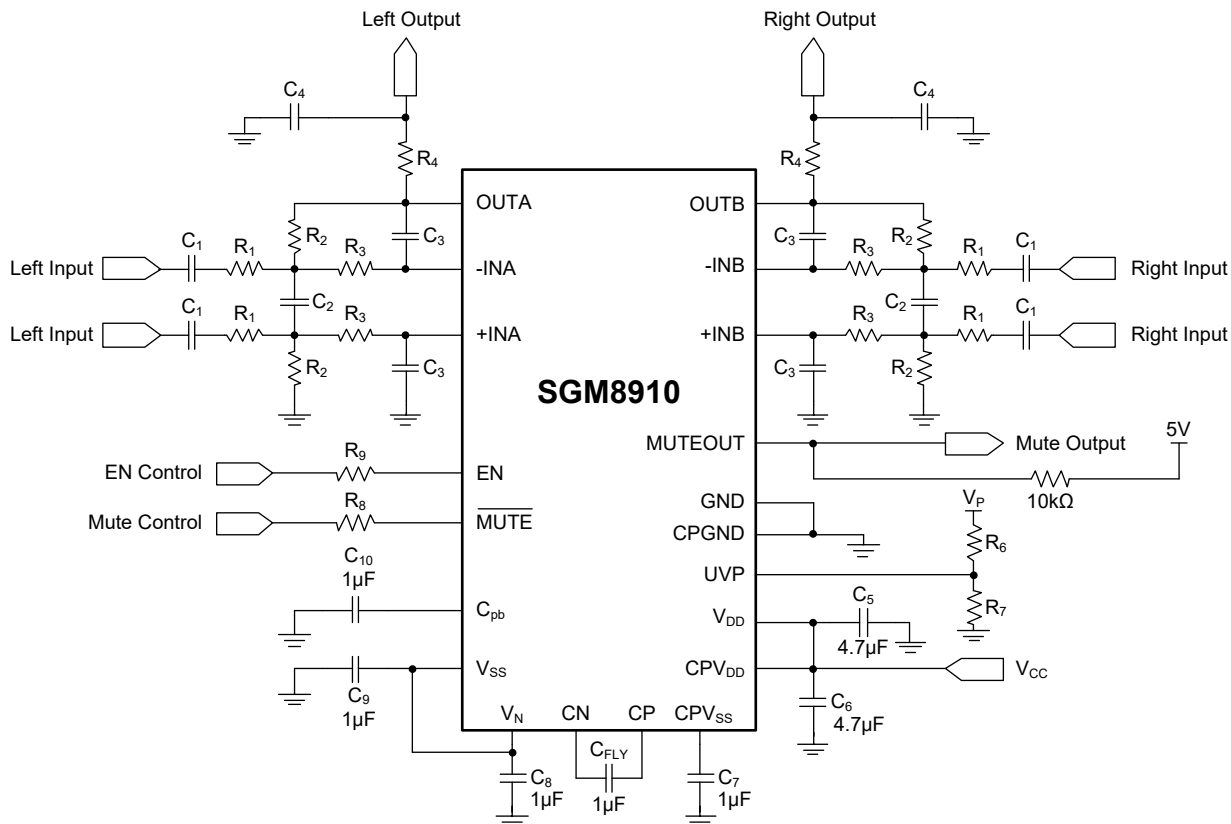

Figure 1. Typical Application Circuit

SGM8910 4Vrms High Performance Audio Line and Headphone Driver with Click-Pop Noise Cancellation

FUNCTIONAL BLOCK DIAGRAM

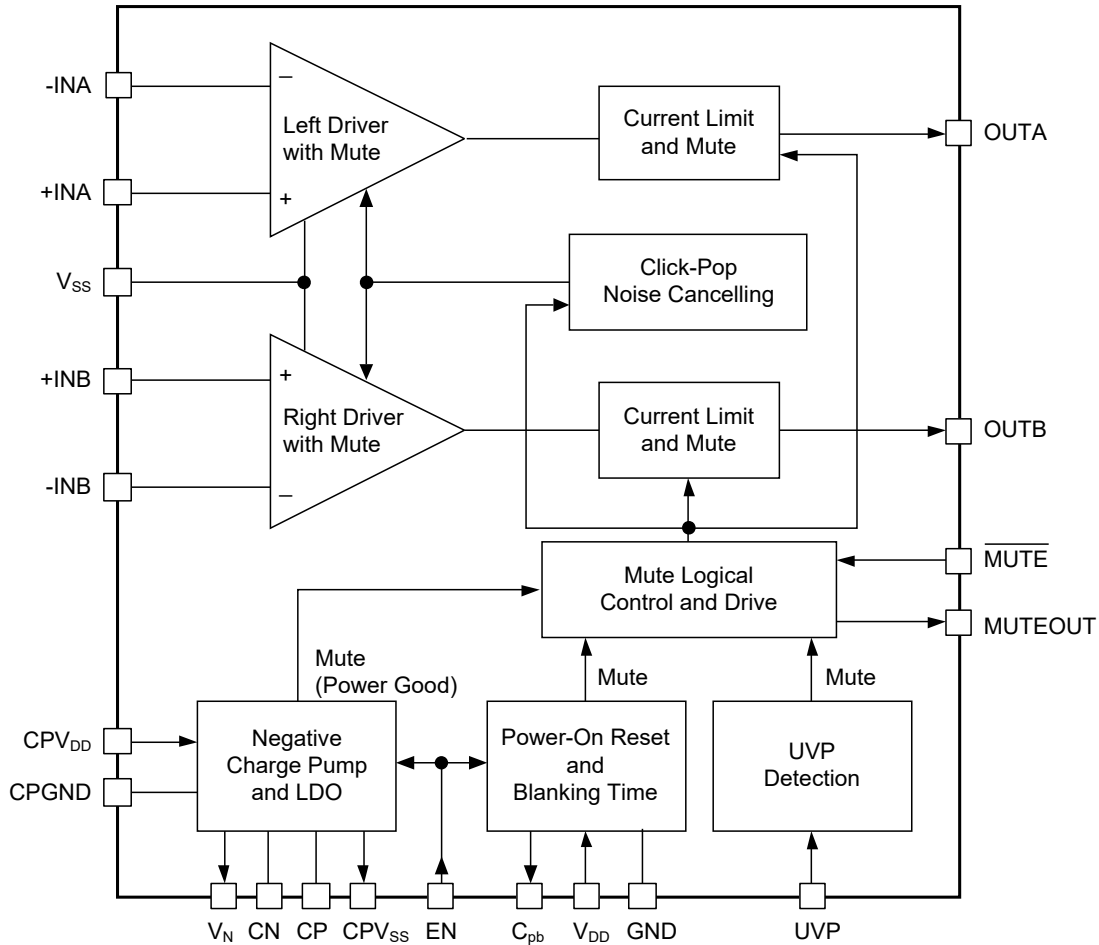

Figure 2. Block Diagram

SGM8910 4Vrms High Performance Audio Line and Headphone Driver with Click-Pop Noise Cancellation

REVISION HISTORY

NOTE: Page numbers for previous revisions may differ from page numbers in the current version.

Changes from Original (FEBRUARY 2018) to REV.A

Changed from product preview to production data.....All

PACKAGE OUTLINE DIMENSIONS

TSSOP-20

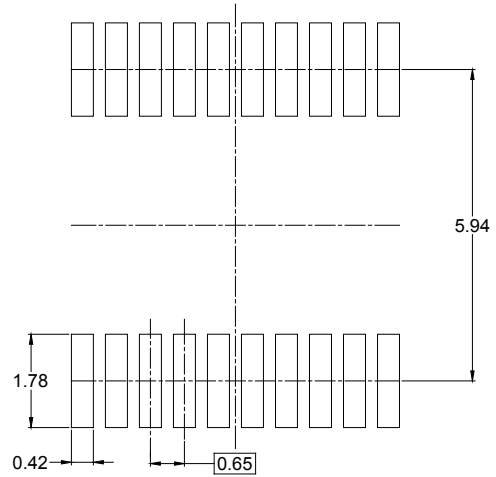
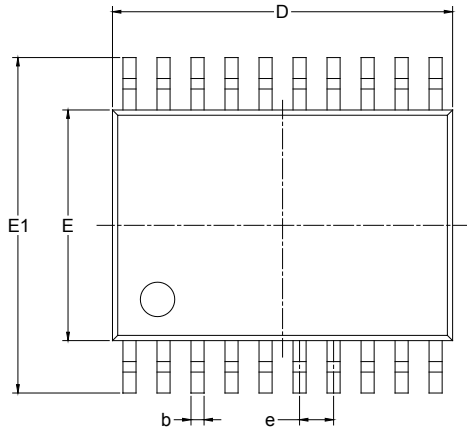

RECOMMENDED LAND PATTERN (Unit: mm)

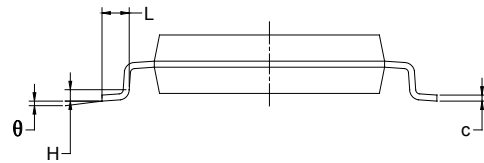
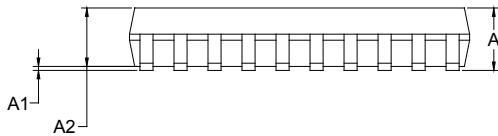

Symbol	Dimensions In Millimeters		Dimensions In Inches	
	MIN	MAX	MIN	MAX
A		1.100		0.043
A1	0.050	0.150	0.002	0.006
A2	0.800	1.000	0.031	0.039
b	0.190	0.300	0.007	0.012
c	0.090	0.200	0.004	0.008
D	6.400	6.600	0.252	0.259
E	4.300	4.500	0.169	0.177
E1	6.250	6.550	0.246	0.258
e	0.650 BSC		0.026 BSC	
L	0.500	0.700	0.02	0.028
H	0.25 TYP		0.01 TYP	
θ	1°	7°	1°	7°

PACKAGE INFORMATION

PACKAGE OUTLINE DIMENSIONS

TQFN-4×4-20L

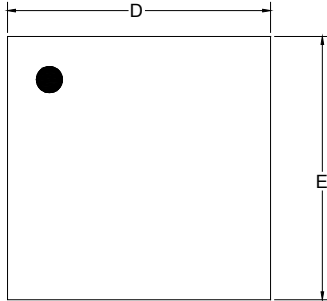

TOP VIEW

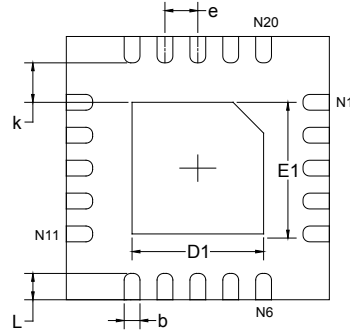

BOTTOM VIEW

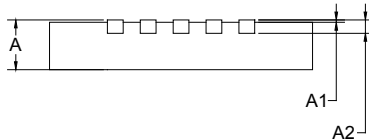

SIDE VIEW

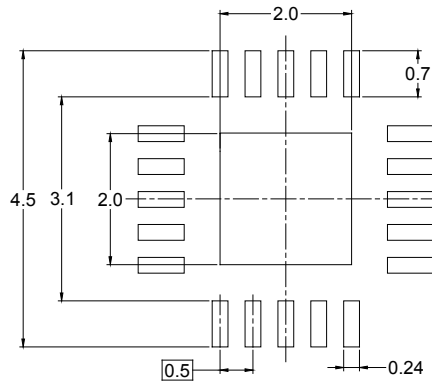

RECOMMENDED LAND PATTERN (Unit: mm)

Symbol	Dimensions In Millimeters		Dimensions In Inches	
	MIN	MAX	MIN	MAX
A	0.700	0.800	0.028	0.031
A1	0.000	0.050	0.000	0.002
A2	0.203 REF		0.008 REF	
D	3.900	4.100	0.154	0.161
D1	1.900	2.100	0.075	0.083
E	3.900	4.100	0.154	0.161
E1	1.900	2.100	0.075	0.083
k	0.200 MIN		0.008 MIN	
b	0.180	0.300	0.007	0.012
e	0.500 TYP		0.020 TYP	
L	0.300	0.500	0.012	0.020

TAPE AND REEL INFORMATION

REEL DIMENSIONS



TAPE DIMENSIONS



NOTE: The picture is only for reference. Please make the object as the standard.

KEY PARAMETER LIST OF TAPE AND REEL

Package Type	Reel Diameter	Reel Width W1 (mm)	A0 (mm)	B0 (mm)	K0 (mm)	P0 (mm)	P1 (mm)	P2 (mm)	W (mm)	Pin1 Quadrant
TSSOP-20	13"	12.4	6.80	6.85	1.70	4.0	8.0	2.0	12.0	Q1
TQFN-4x4-20L	13"	12.4	4.30	4.30	1.10	4.0	8.0	2.0	12.0	Q2

DD0001

PACKAGE INFORMATION

CARTON BOX DIMENSIONS



NOTE: The picture is only for reference. Please make the object as the standard.

KEY PARAMETER LIST OF CARTON BOX

Reel Type	Length (mm)	Width (mm)	Height (mm)	Pizza/Carton
13"	386	280	370	5

DD0002