

THIS DRAWING IS UNPUBLISHED. RELEASED FOR PUBLICATION 20
 © COPYRIGHT 20 BY - ALL RIGHTS RESERVED.

REVISIONS				
P	LTR	DESCRIPTION	DATE	APVD
F		ECR-21-119335	25JUN2022	TL HL

NOTES:

- 1 MATERIAL:
HOUSING: LCP UL94V-0; BLACK
CONTACT: COPPER ALLOY
HOLD DOWN: BRASS
- 2 FINISH:
(SEE TABLE)um GOLD PLATING ON CONTACT AREA.
2.54um MATTE-TIN PLATING ON SOLDER TAIL AREA.
1.27um NICKEL UNDERPLATING OVERALL.
- 3 PARTS WITH POS 36 ARE NOT TOOLED

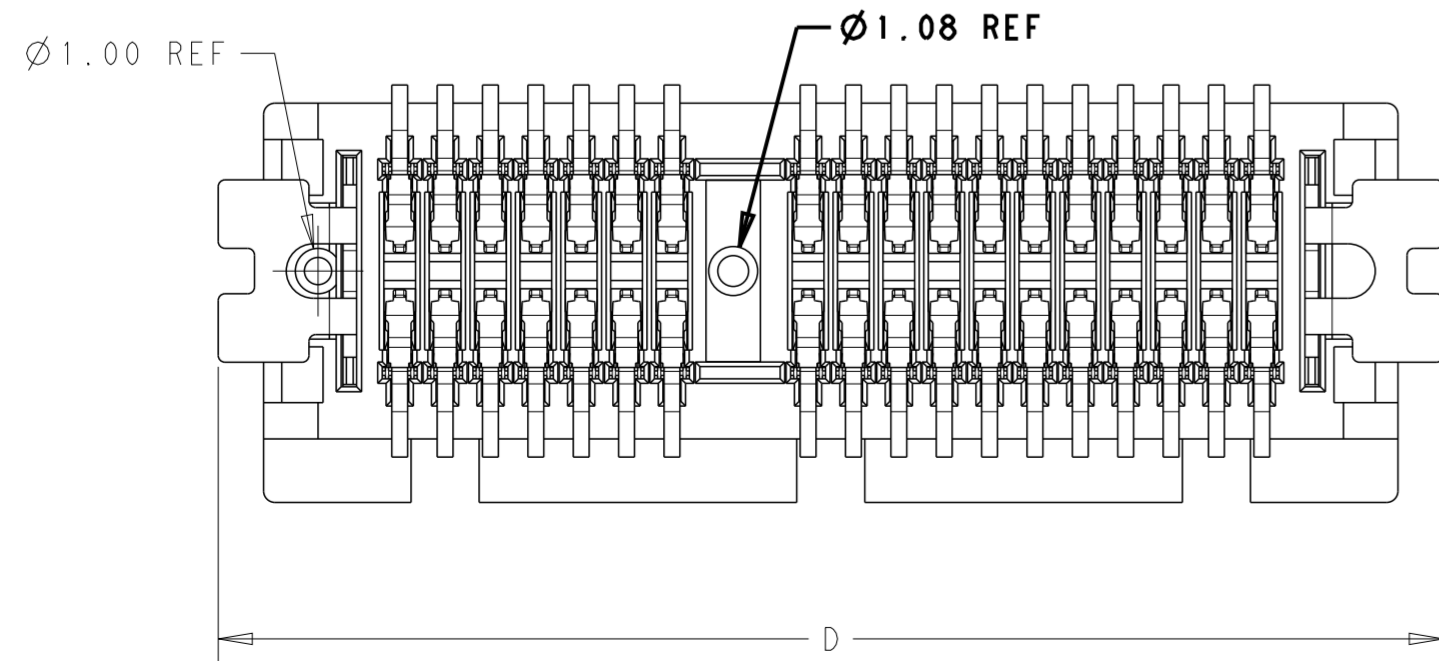
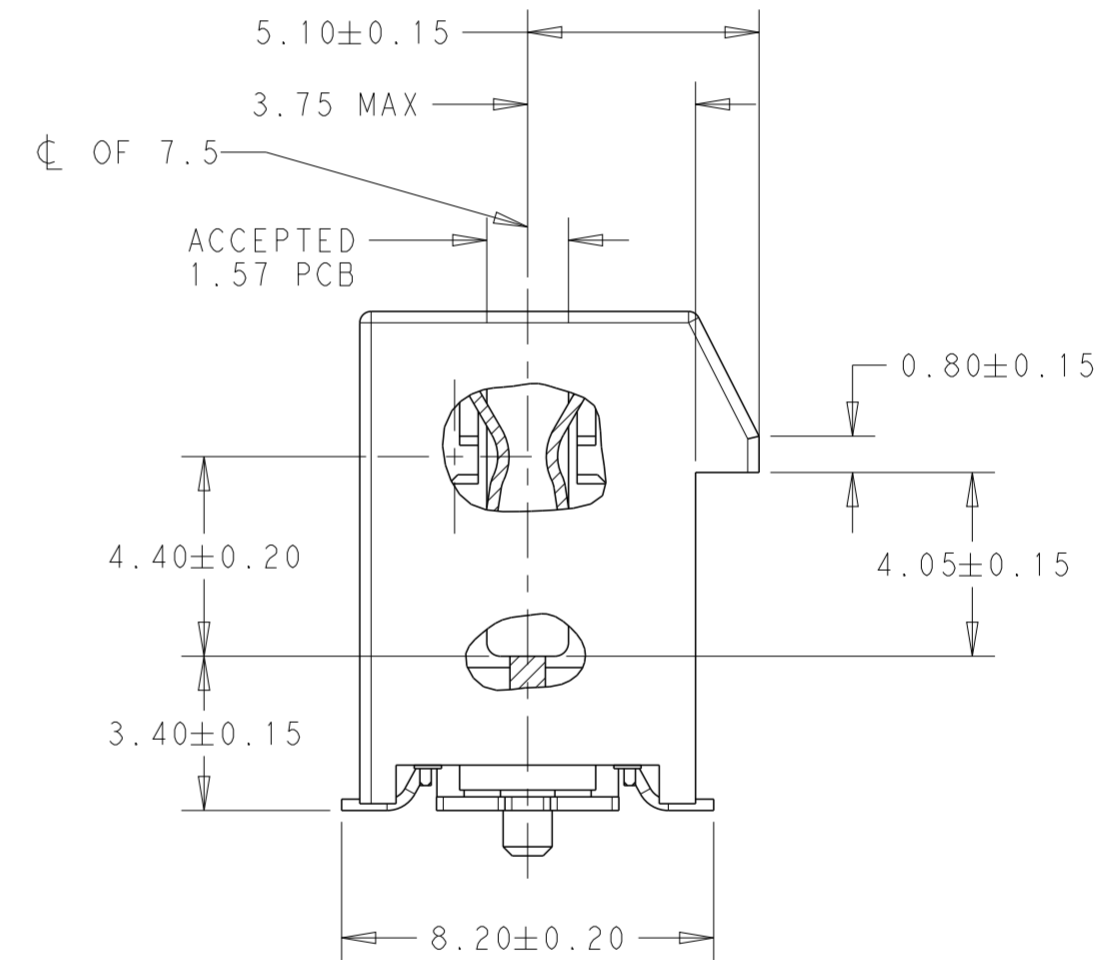
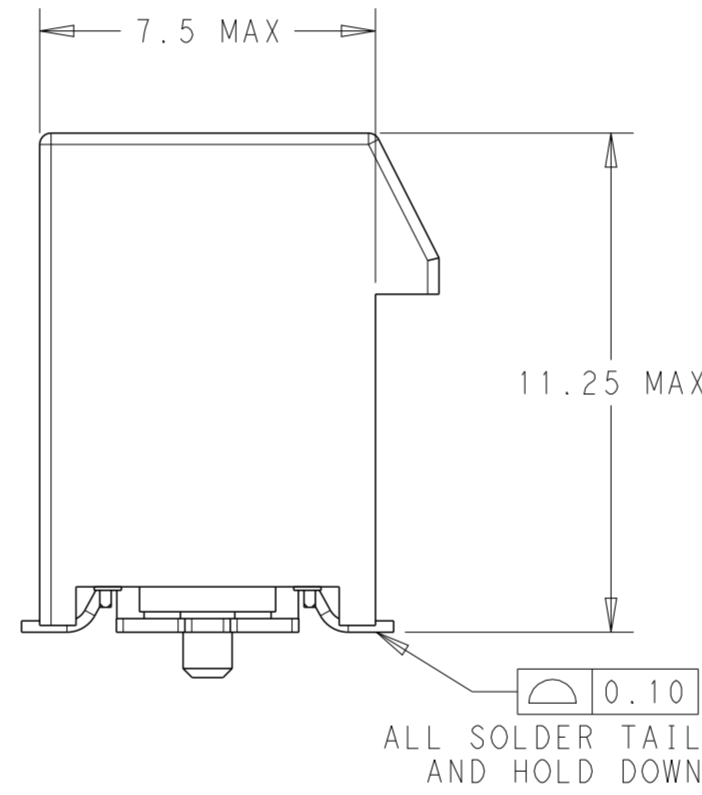
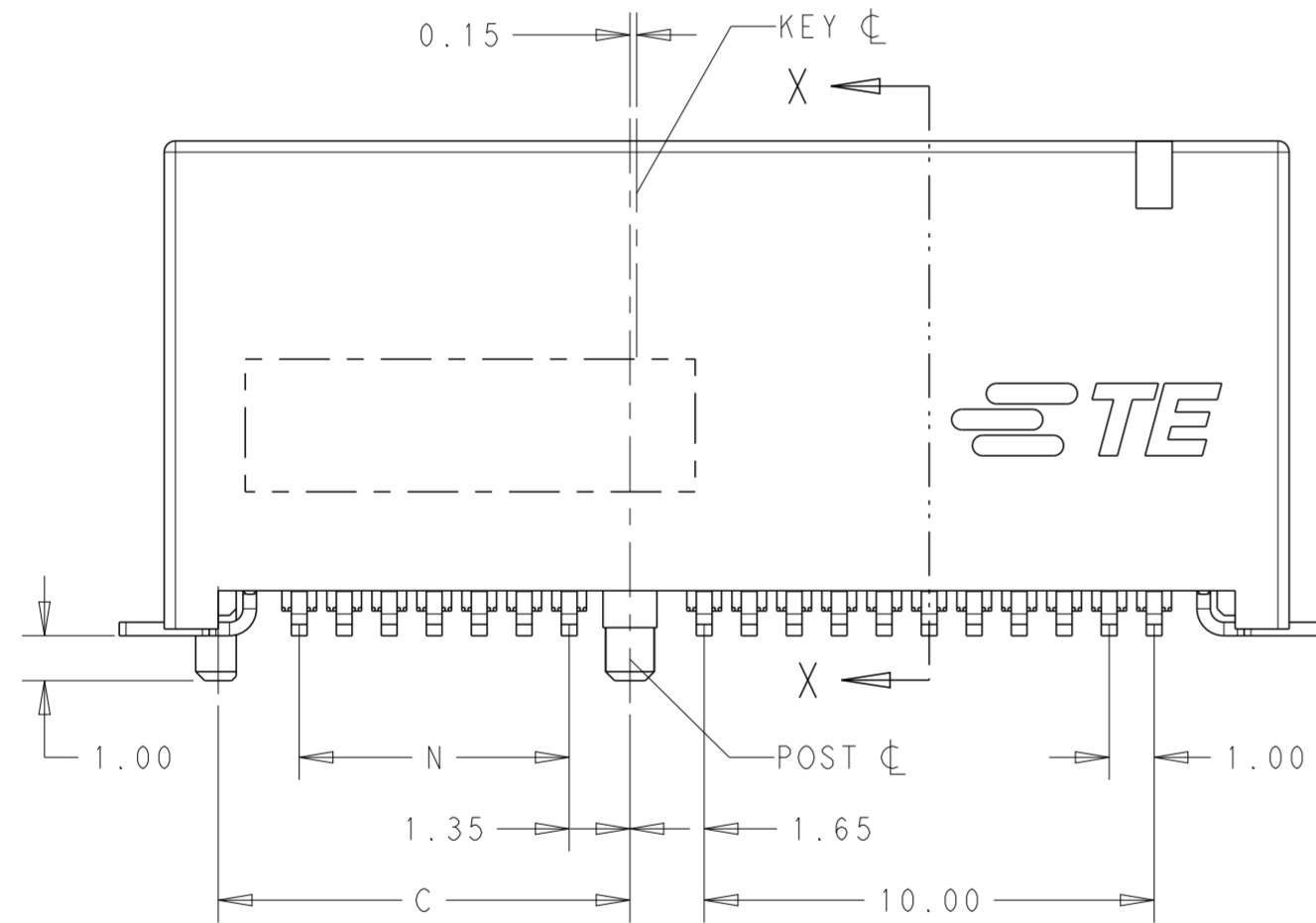
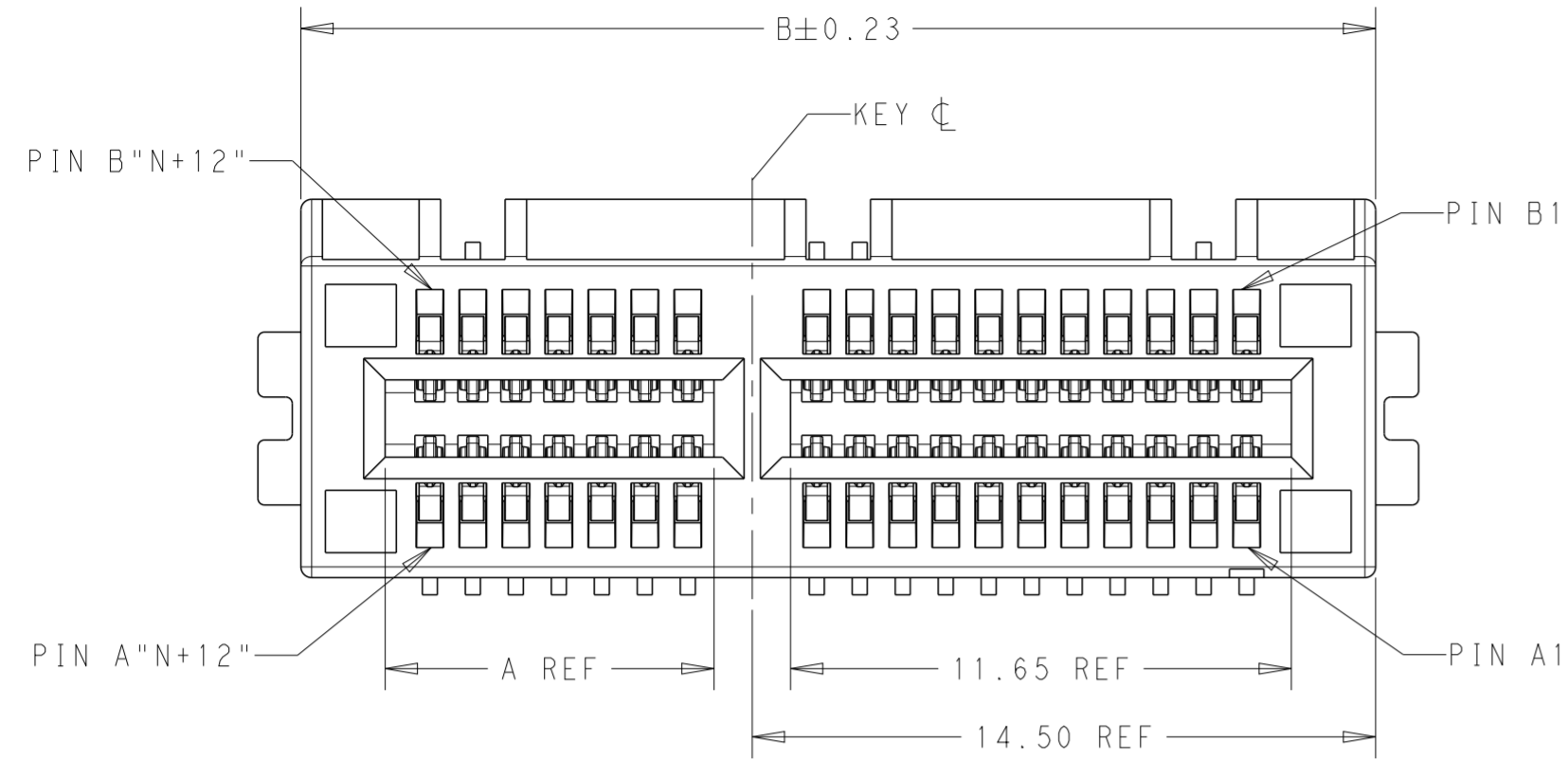

THIS DRAWING IS A CONTROLLED DOCUMENT.		DWN FRED LIU 12JUN2018		
DIMENSIONS: mm		CHK HOPE LU 12JUN2018		
TOLERANCES UNLESS OTHERWISE SPECIFIED:		APVD HOPE LU 12JUN2018	NAME PCI EXPRESS CARD EDGE CONNECTOR	
0 PLC ±		PRODUCT SPEC	GEN4, STANDARD VERSION	
1 PLC ±0.3		APPLICATION SPEC	SIZE	CAGE CODE
2 PLC ±0.20		WEIGHT	A200779	C-2337939
3 PLC ±0.050		CUSTOMER DRAWING	SCALE 3:1	SHEET 1 OF 6
4 PLC ±				REV F
ANGLES ±				
FINISH				

THIS DRAWING IS UNPUBLISHED. RELEASED FOR PUBLICATION 20
 © COPYRIGHT 20 BY - ALL RIGHTS RESERVED.

REVISIONS					
P	LTR	DESCRIPTION	DATE	DWN	APVD
-	-	SEE SHEET 1	-	-	-

PACKAGE	PRODUCT SPEC	GOLD PLATING	W	V	J	D	N	C	B	A	POS.	PART NUMBER
			MYLAR SIZE (PAGE 4)									
PACKAGE 2	108-60121	30u"	45.0	8.0	44.5	91	70	73.15	89	71.65	164	7-2337939-4
PACKAGE 1		30u"	86.5		44.5	91	70	73.15	89	71.65	164	5-2337939-8
PACKAGE 4		30u"	53.5		28	58	37	40.15	56	38.65	98	5-2337939-7
PACKAGE 3		30u"	36.5		19.5	41	20	23.15	39	21.65	64	5-2337939-6
NA		30u"	22.5		12.5	27	6	9.15	25	7.65	36	5-2337939-5
PACKAGE 1		30u"	10.0		44.5	91	70	73.15	89	71.65	164	5-2337939-4
PACKAGE 4		30u"	10.0		28	58	37	40.15	56	38.65	98	5-2337939-3
PACKAGE 3		30u"	10.0		19.5	41	20	23.15	39	21.65	64	5-2337939-2
NA		30u"	10.0		12.5	27	6	9.15	25	7.65	36	5-2337939-1
PACKAGE 1		108-60121-1	15u"		86.5	44.5	91	70	73.15	89	71.65	164
PACKAGE 4	15u"		53.5	28	58	37	40.15	56	38.65	98	4-2337939-7	
PACKAGE 3	15u"		36.5	19.5	41	20	23.15	39	21.65	64	4-2337939-6	
NA	15u"		22.5	12.5	27	6	9.15	25	7.65	36	4-2337939-5	
PACKAGE 1	15u"		10.0	44.5	91	70	73.15	89	71.65	164	4-2337939-4	
PACKAGE 4	15u"		10.0	28	58	37	40.15	56	38.65	98	4-2337939-3	
PACKAGE 3	15u"		10.0	19.5	41	20	23.15	39	21.65	64	4-2337939-2	
NA	15u"		10.0	12.5	27	6	9.15	25	7.65	36	4-2337939-1	
PACKAGE 1	G/F		86.5	44.5	91	70	73.15	89	71.65	164	3-2337939-8	
PACKAGE 4	G/F		53.5	28	58	37	40.15	56	38.65	98	3-2337939-7	
PACKAGE 3	G/F	36.5	19.5	41	20	23.15	39	21.65	64	3-2337939-6		
NA	G/F	22.5	12.5	27	6	9.15	25	7.65	36	3-2337939-5		
PACKAGE 1	G/F	10.0	44.5	91	70	73.15	89	71.65	164	3-2337939-4		
PACKAGE 4	G/F	10.0	28	58	37	40.15	56	38.65	98	3-2337939-3		
PACKAGE 3	G/F	10.0	19.5	41	20	23.15	39	21.65	64	3-2337939-2		
NA	G/F	10.0	12.5	27	6	9.15	25	7.65	36	3-2337939-1		
PACKAGE 2	108-60121	30u"	NA	44.5	91	70	73.15	89	71.65	164	2-2337939-5	
PACKAGE 1		30u"	NA	44.5	91	70	73.15	89	71.65	164	2-2337939-4	
PACKAGE 4		30u"	NA	28	58	37	40.15	56	38.65	98	2-2337939-3	
PACKAGE 3		30u"	NA	19.5	41	20	23.15	39	21.65	64	2-2337939-2	
NA	30u"	NA	12.5	27	6	9.15	25	7.65	36	2-2337939-1		
PACKAGE 1	108-60121-1	15u"	NA	44.5	91	70	73.15	89	71.65	164	6-2337939-4	
PACKAGE 4		15u"	NA	28	58	37	40.15	56	38.65	98	6-2337939-3	
PACKAGE 3		15u"	NA	19.5	41	20	23.15	39	21.65	64	6-2337939-2	
NA		15u"	NA	12.5	27	6	9.15	25	7.65	36	6-2337939-1	
PACKAGE 1		G/F	NA	44.5	91	70	73.15	89	71.65	164	2337939-4	
PACKAGE 4		G/F	NA	28	58	37	40.15	56	38.65	98	2337939-3	
PACKAGE 3		G/F	NA	19.5	41	20	23.15	39	21.65	64	2337939-2	
NA	G/F	NA	12.5	27	6	9.15	25	7.65	36	2337939-1		

THIS DRAWING IS A CONTROLLED DOCUMENT.		DWN FRED LIU 12JUN2018	 TE Connectivity NAME PCI EXPRESS CARD EDGE CONNECTOR GEN4 , STANDARD VERSION
DIMENSIONS: mm		CHK HOPE LU 12JUN2018	
TOLERANCES UNLESS OTHERWISE SPECIFIED: 0 PLC ± 1 PLC ±0.3 2 PLC ±0.20 3 PLC ±0.050 4 PLC ± ANGLES ± FINISH		APVD HOPE LU 12JUN2018	
MATERIAL		PRODUCT SPEC	
		APPLICATION SPEC	SIZE
		WEIGHT	CAGE CODE
		CUSTOMER DRAWING	DRAWING NO
		SCALE 3:1	RESTRICTED TO
		SHEET 2 OF 6	REV F

THIS DRAWING IS UNPUBLISHED. RELEASED FOR PUBLICATION 20
 © COPYRIGHT 20 BY - ALL RIGHTS RESERVED.

REVISIONS					
P	LTR	DESCRIPTION	DATE	DWN	APVD
-	-	SEE SHEET 1	-	-	-

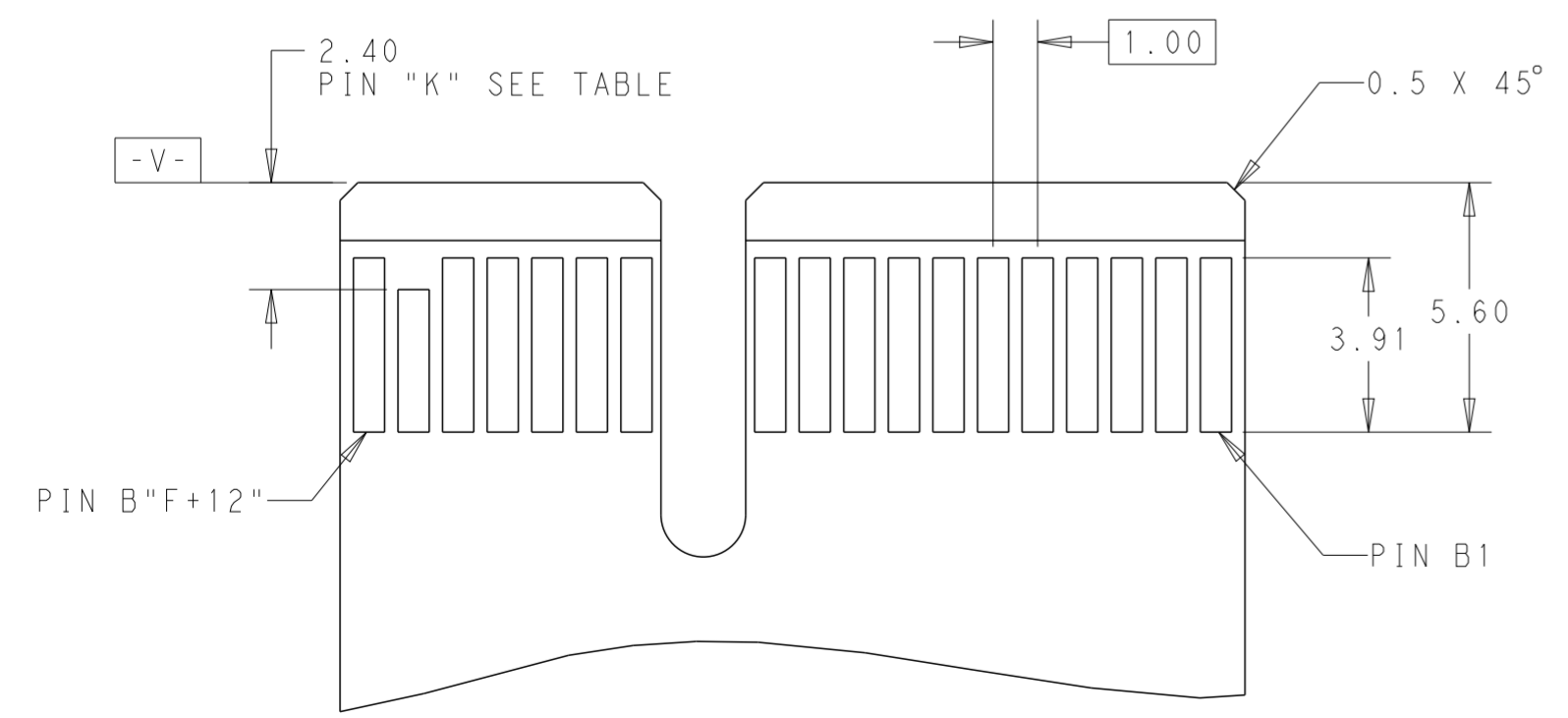
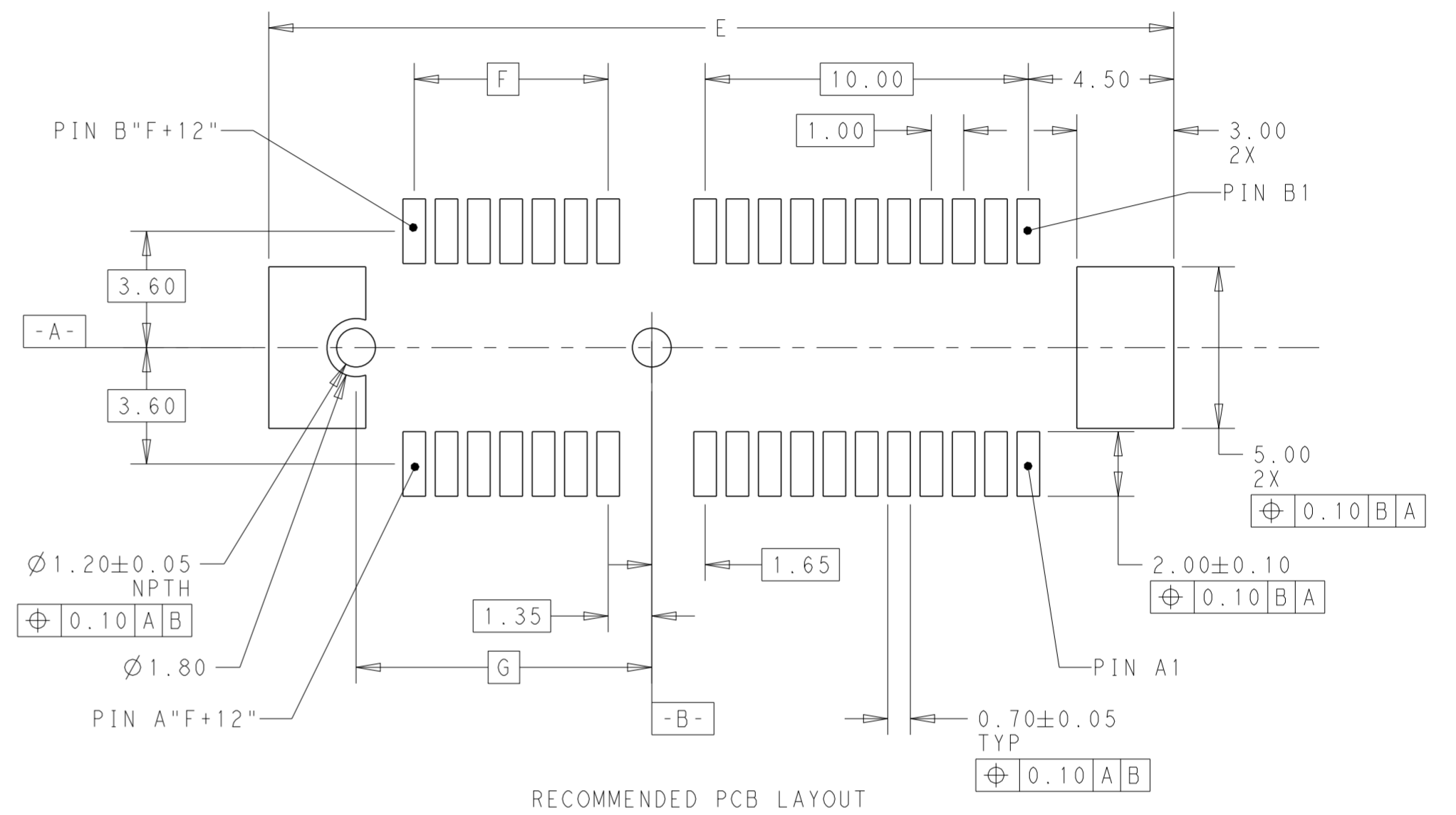
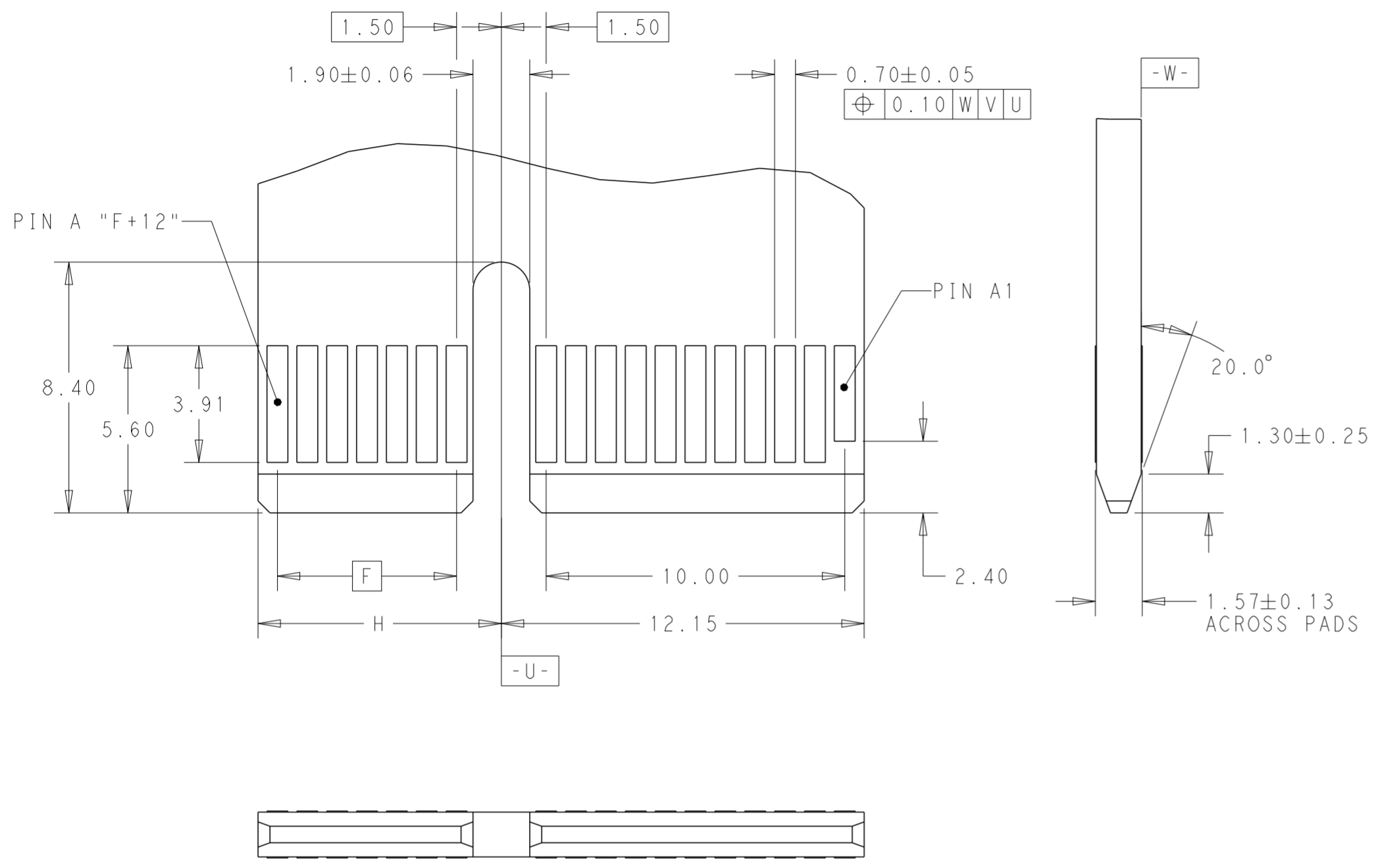

164	92.00	70	73.15	72.15	A1,B17,B31,B48,B81
98	59.00	37	40.15	39.15	A1,B17,B31,B48
64	42.00	20	23.15	22.15	A1,B17,B31
36	28.00	6	9.15	8.15	A1,B17
POS.	DIM. E	DIM. F	DIM. G	DIM. H	"K"

THIS DRAWING IS A CONTROLLED DOCUMENT.

DWN FRED LIU 12JUN2018	 TE Connectivity PCI EXPRESS CARD EDGE CONNECTOR GEN4, STANDARD VERSION					
CHK HOPE LU 12JUN2018						
APVD HOPE LU 12JUN2018						
NAME						
DIMENSIONS: mm	TOLERANCES UNLESS OTHERWISE SPECIFIED:	PRODUCT SPEC	SIZE	CAGE CODE	DRAWING NO	RESTRICTED TO
0 PLC ±	1 PLC ±0.3	-	A2	00779	C-2337939	-
2 PLC ±0.20	3 PLC ±0.050	APPLICATION SPEC	SCALE	SHEET	OF	REV
4 PLC ±	ANGLES ±	-	3:1	3	6	F
MATERIAL	FINISH	WEIGHT	CUSTOMER DRAWING			
-	-	-				

THIS DRAWING IS UNPUBLISHED. RELEASED FOR PUBLICATION 20
 © COPYRIGHT 20 BY - ALL RIGHTS RESERVED.

REVISIONS					
P	LTR	DESCRIPTION	DATE	DWN	APVD
-		SEE SHEET 1	-	-	-

FRONT VIEW

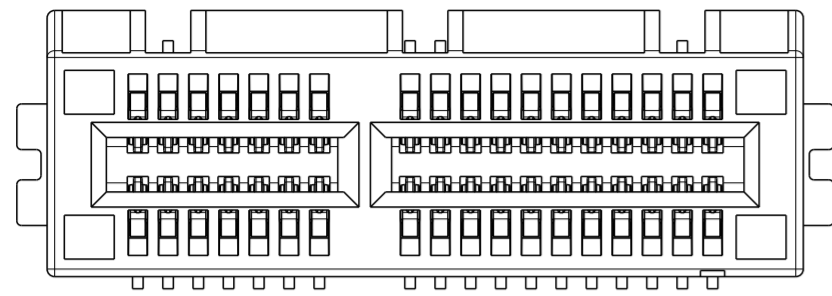

36POS AS SHOWN

REAR VIEW

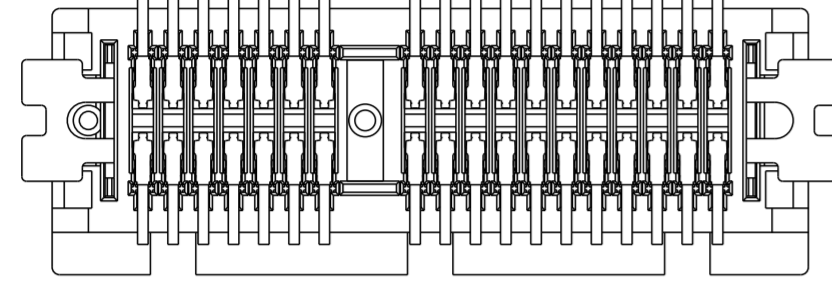

FRONT VIEW

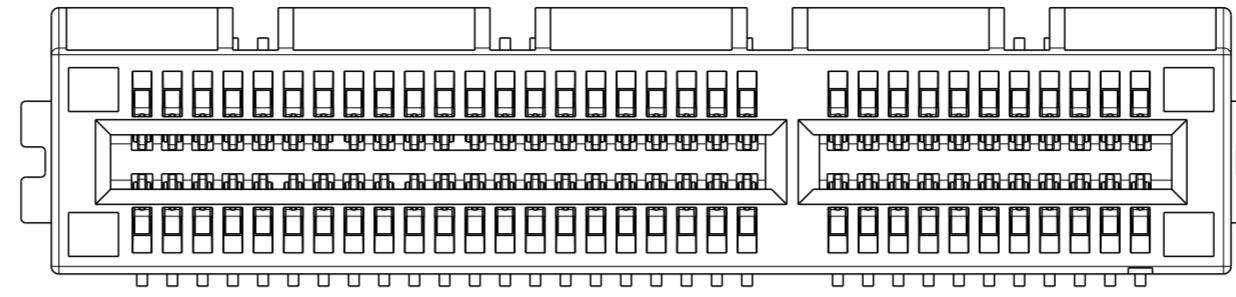

64POS AS SHOWN

REAR VIEW

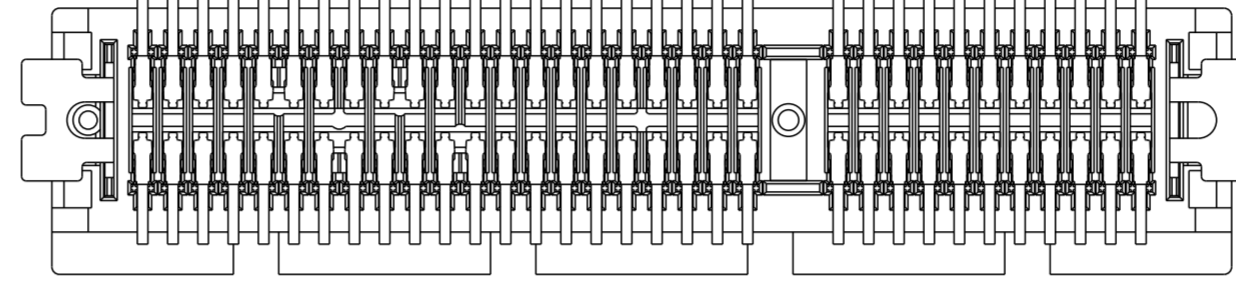

FRONT VIEW

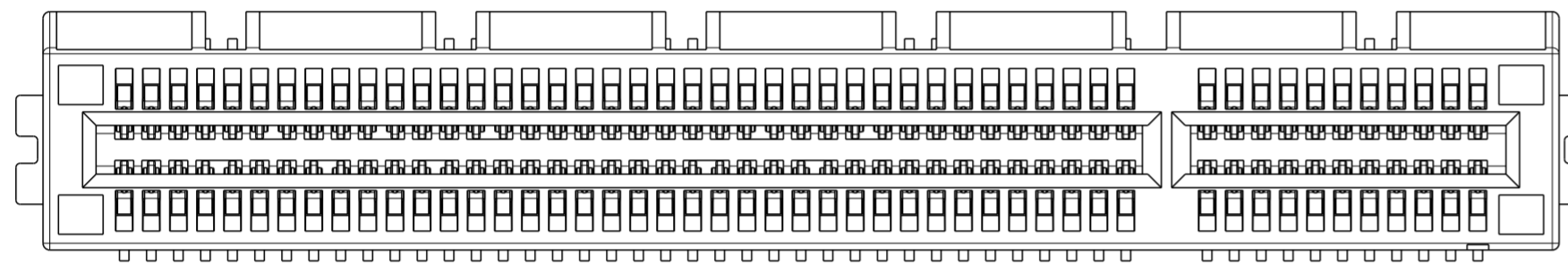

98POS AS SHOWN

REAR VIEW

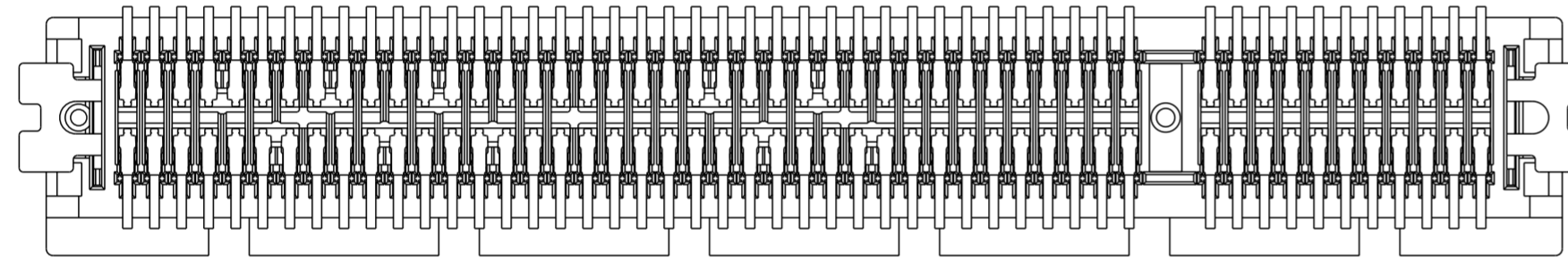

FRONT VIEW

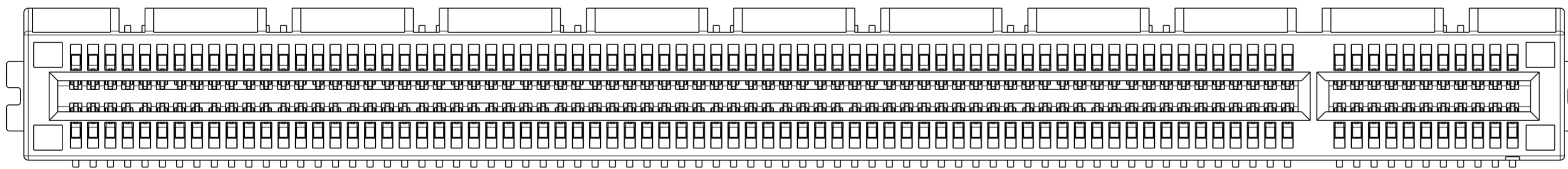

164POS AS SHOWN

REAR VIEW

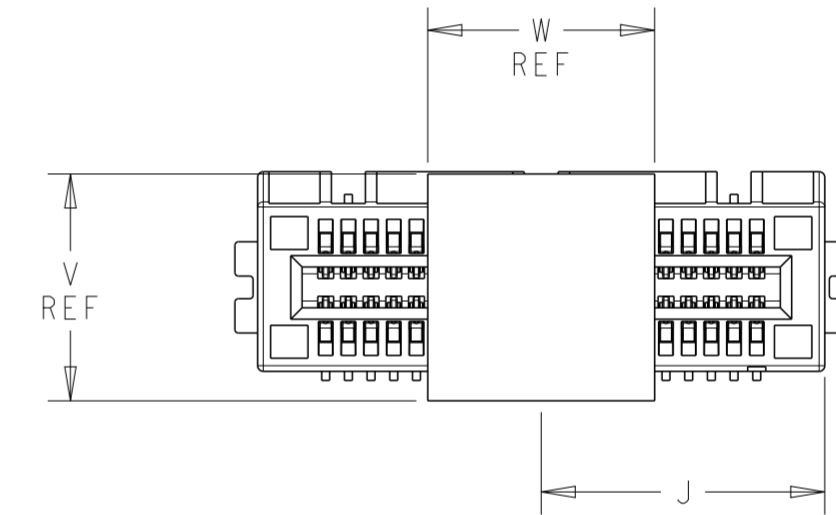
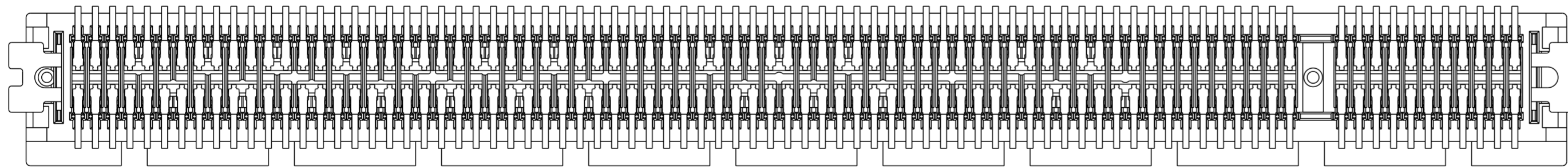

MYLAR SIZE

THIS DRAWING IS A CONTROLLED DOCUMENT.		DWN FRED LIU 12JUN2018	 TE Connectivity		
DIMENSIONS: mm		CHK HOPE LU 12JUN2018			
TOLERANCES UNLESS OTHERWISE SPECIFIED: 0 PLC ±0.3 1 PLC ±0.20 2 PLC ±0.20 3 PLC ±0.050 4 PLC ± ANGLES ± FINISH ±		APVD HOPE LU 12JUN2018	NAME PCI EXPRESS CARD EDGE CONNECTOR		
MATERIAL		PRODUCT SPEC	GEN4, STANDARD VERSION		
		APPLICATION SPEC	SIZE	CAGE CODE	DRAWING NO
		WEIGHT	A2	00779	C-2337939
		CUSTOMER DRAWING	SCALE	SHEET	REV
			3:1	4 OF 6	F

THIS DRAWING IS UNPUBLISHED. RELEASED FOR PUBLICATION 20
 © COPYRIGHT 20 BY - ALL RIGHTS RESERVED.

REVISIONS				
P	LTR	DESCRIPTION	DATE	APVD
-	-	SEE SHEET 1	-	-

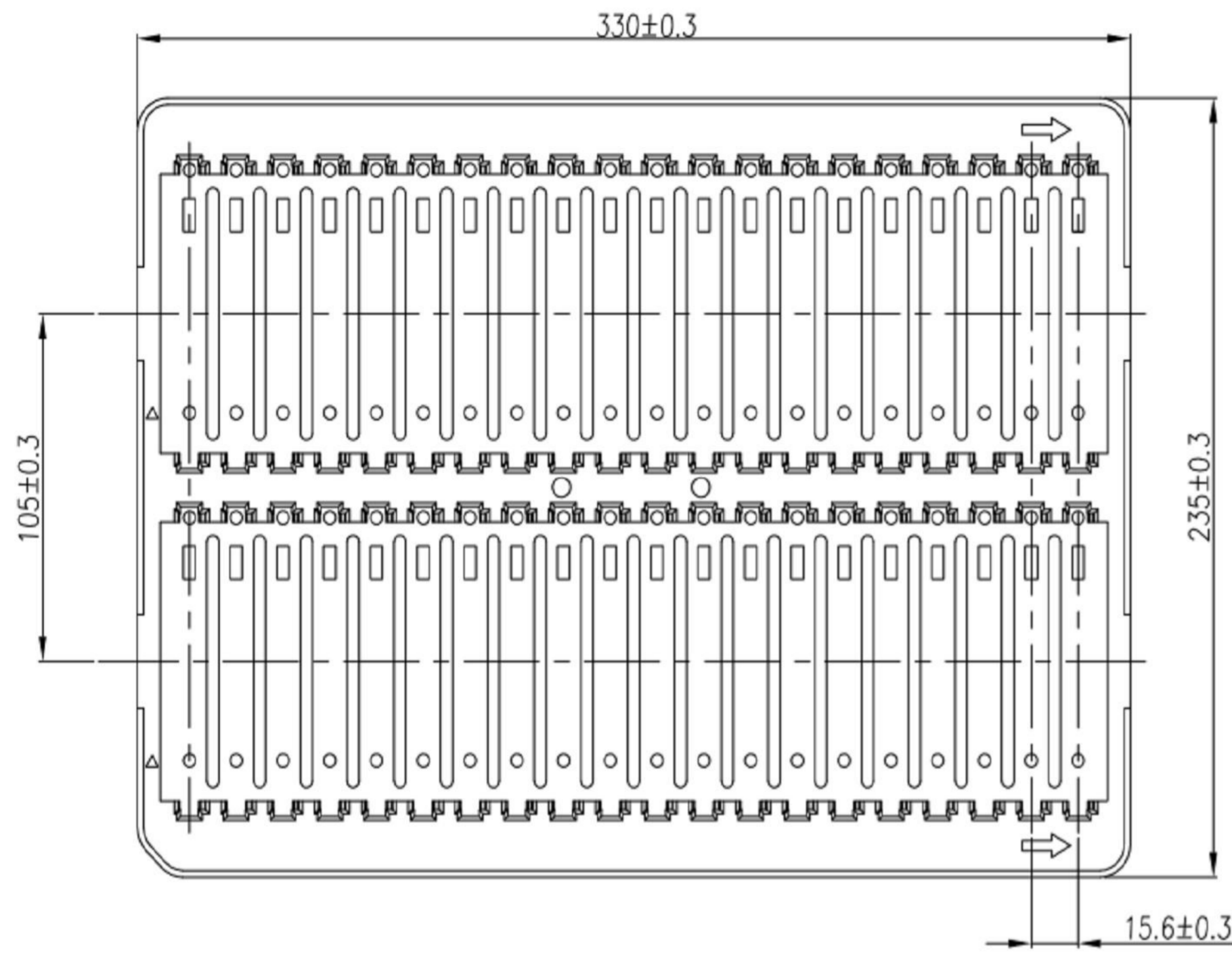

PACKAGE 1

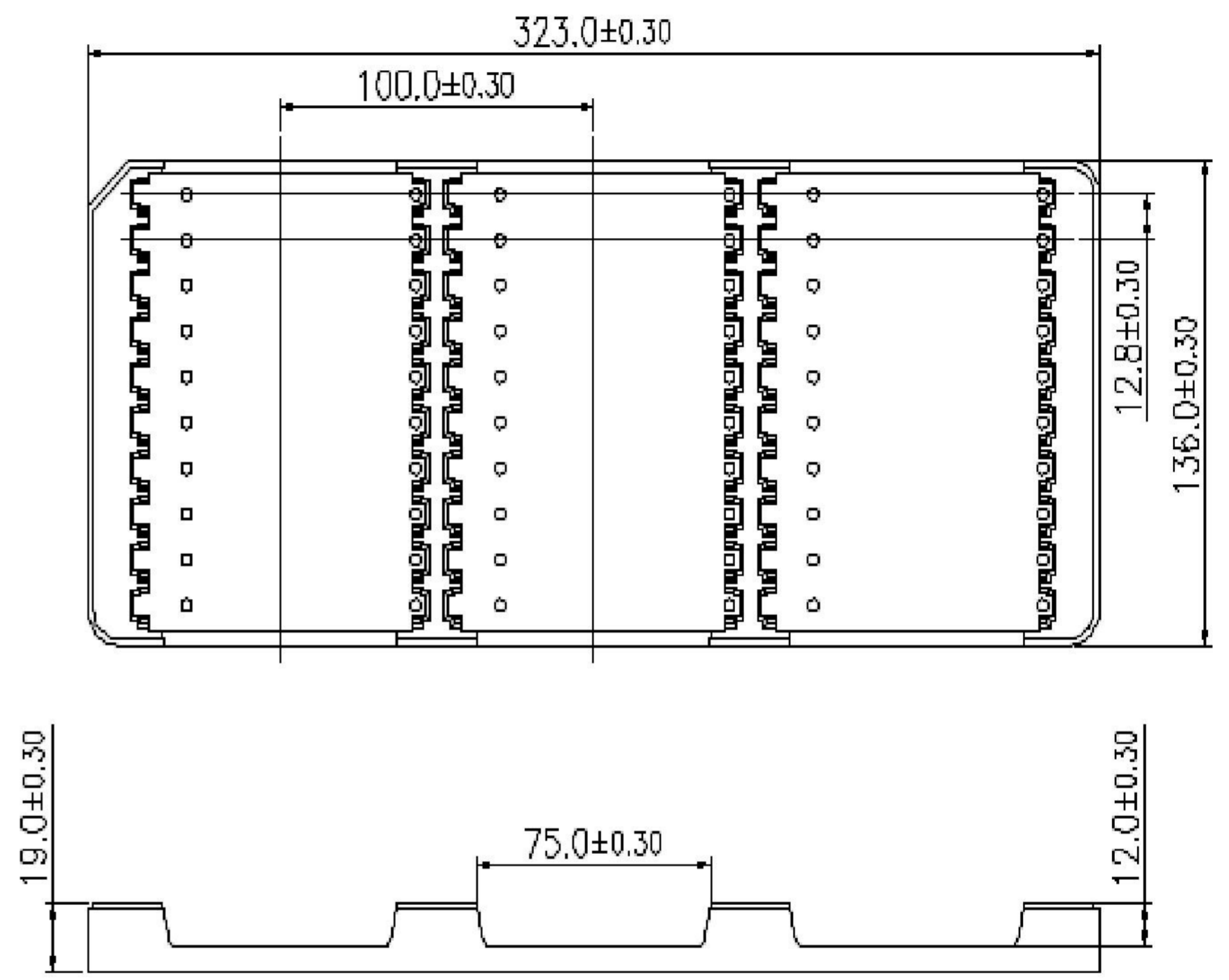
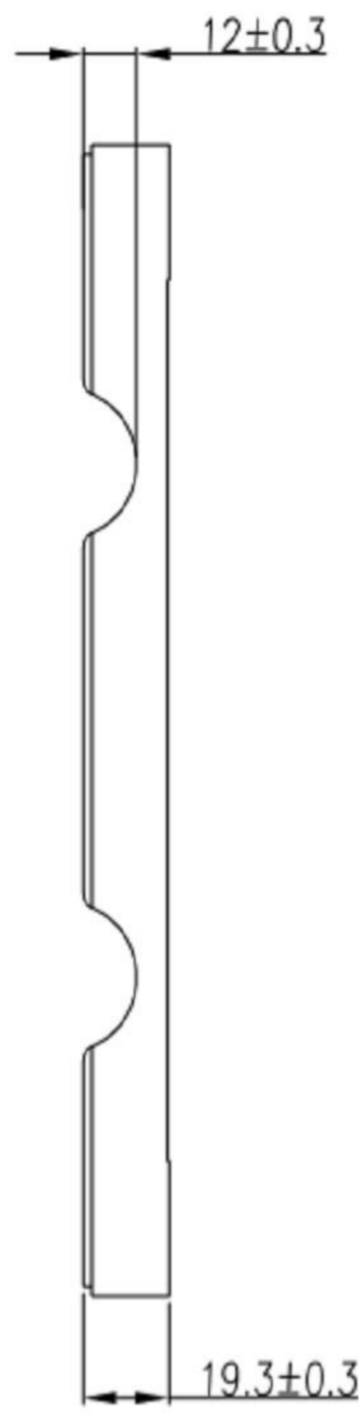

PACKAGE 2

THIS DRAWING IS A CONTROLLED DOCUMENT.		DWN FRED LIU 12JUN2018	STE TE Connectivity	
		CHK HOPE LU 12JUN2018		
DIMENSIONS: mm		APVD HOPE LU 12JUN2018	NAME PCI EXPRESS CARD EDGE CONNECTOR	
TOLERANCES UNLESS OTHERWISE SPECIFIED:		PRODUCT SPEC	GEN4 , STANDARD VERSION	
0 PLC ±		APPLICATION SPEC	SIZE	RESTRICTED TO
1 PLC ±0.3		WEIGHT	A200779	5 OF 6
2 PLC ±0.20		CUSTOMER DRAWING	C-2337939	REV F
3 PLC ±0.050		SCALE 3:1	SHEET 5 OF 6	
4 PLC ±				
ANGLES ±				
FINISH				

THIS DRAWING IS UNPUBLISHED. RELEASED FOR PUBLICATION 20
 © COPYRIGHT 20 BY - ALL RIGHTS RESERVED.

REVISIONS				
P	LTR	DESCRIPTION	DATE	APVD
-	-	SEE SHEET 1	-	-

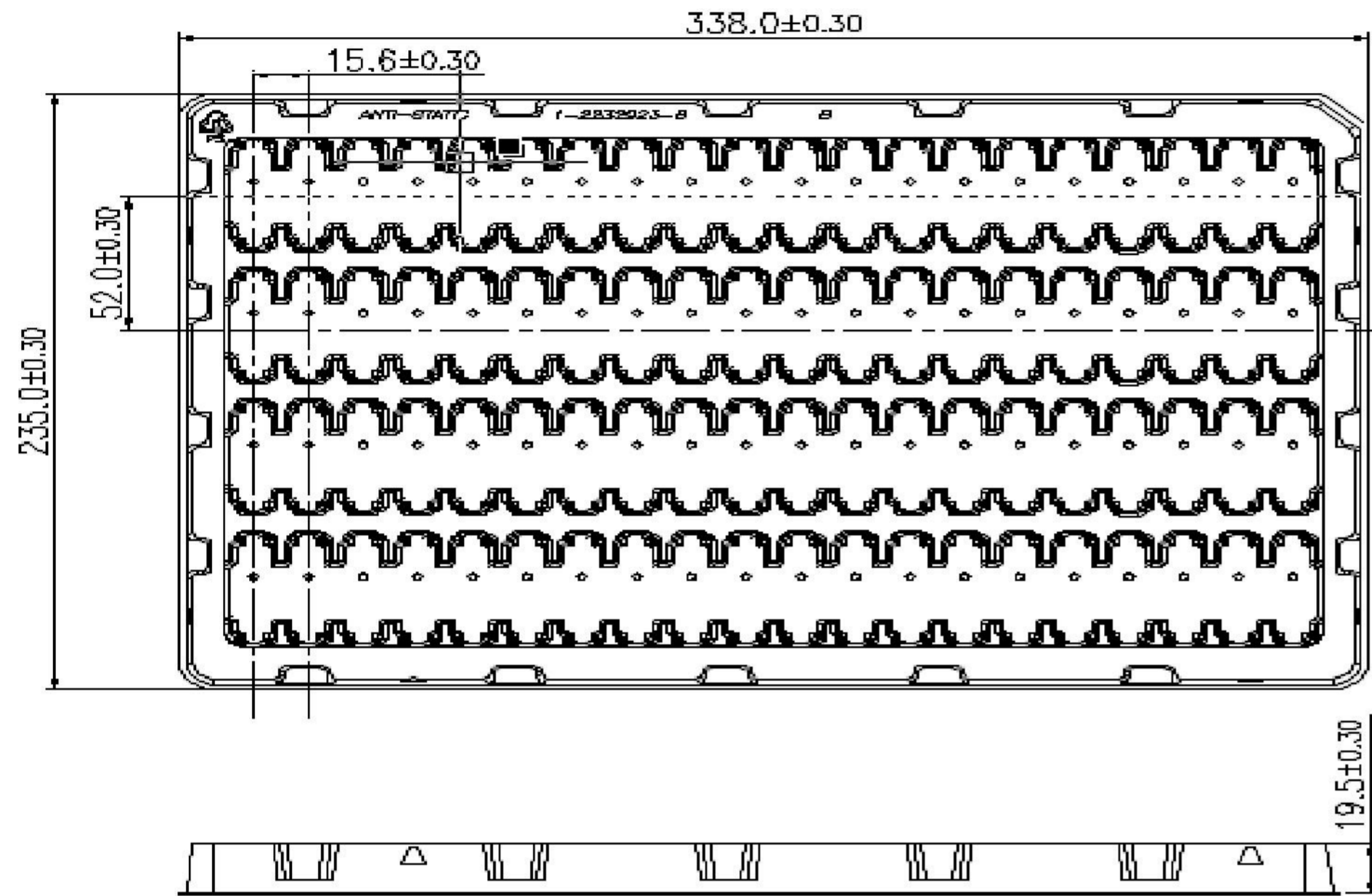

PACKAGE 3

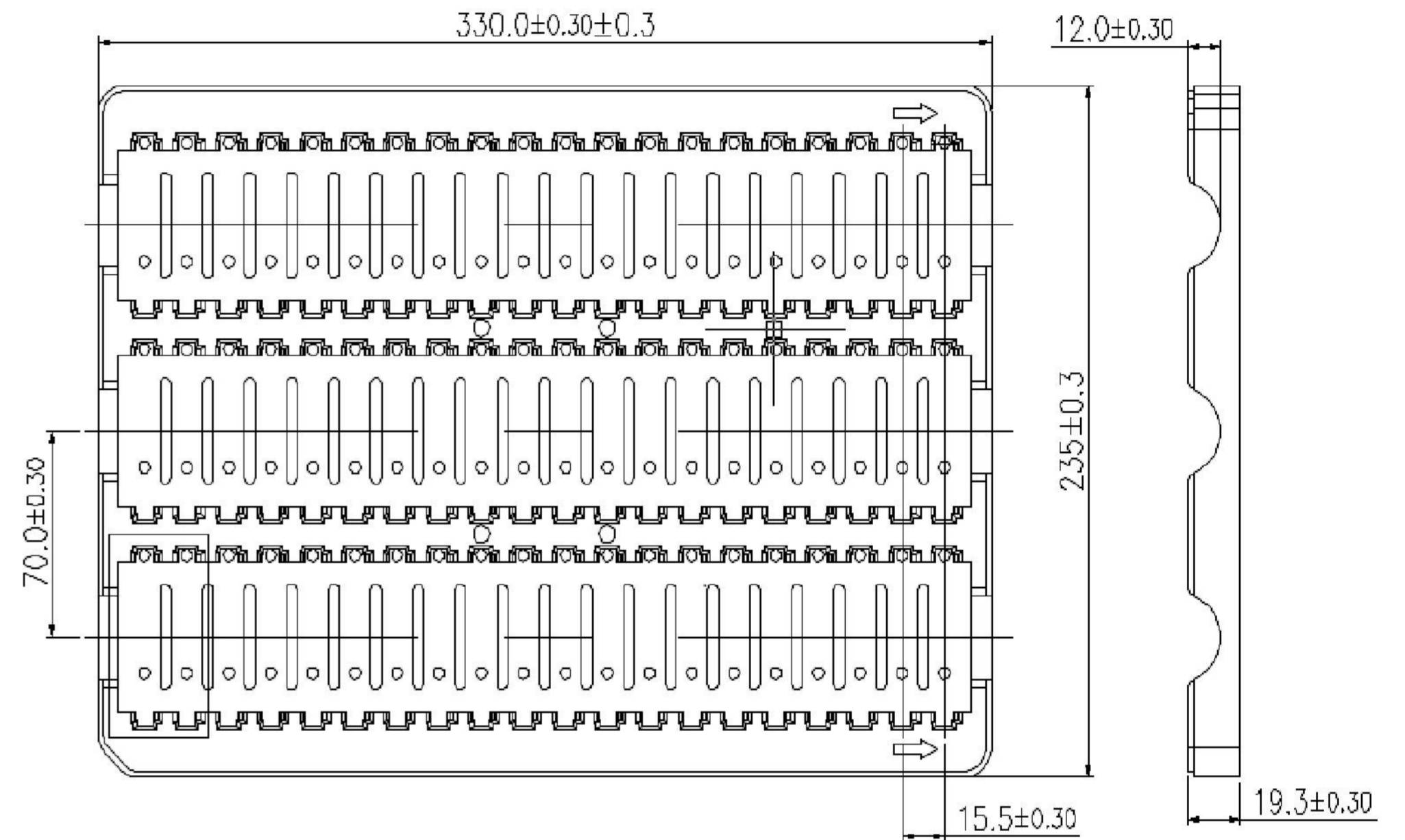

PACKAGE 4

THIS DRAWING IS A CONTROLLED DOCUMENT.		DWN FRED LIU 12 JUN 2018	STE TE Connectivity	
		CHK HOPE LU 12 JUN 2018		
DIMENSIONS: mm		APVD HOPE LU 12 JUN 2018	NAME PCI EXPRESS CARD EDGE CONNECTOR	
TOLERANCES UNLESS OTHERWISE SPECIFIED:		PRODUCT SPEC	GEN4, STANDARD VERSION	
0 PLC ±-		APPLICATION SPEC	SIZE	RESTRICTED TO
1 PLC ±0.3		WEIGHT	A200779	6 OF 6
2 PLC ±0.20		CUSTOMER DRAWING	C-2337939	REV F
3 PLC ±0.050		SCALE 3:1	SHEET 6 OF 6	
4 PLC ±-				
ANGLES ±-				
FINISH				