

Ultra Small Surface Mount Coaxial Connectors 1.4mm or 1.65mm Mated Height

W.FL Series

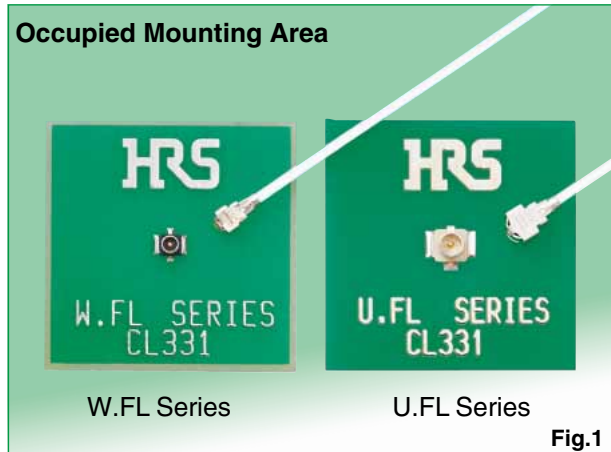
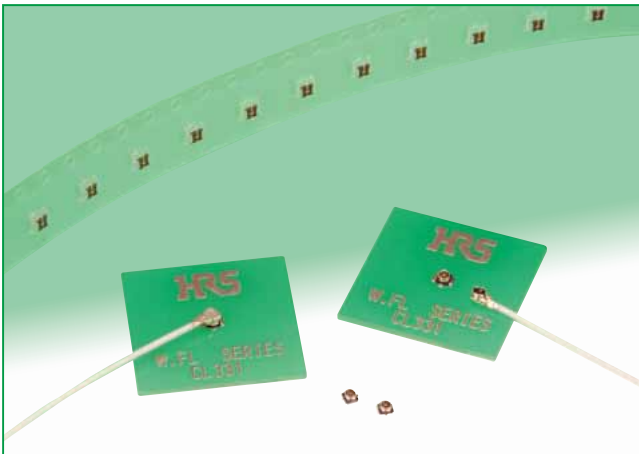

Fig.1

■ Features

1. Nominal mated height of 1.4 mm or 1.65mm (Max. 1.55 or 1.85mm)(Fig.2)

2. Small board footprint

The W.FL Series is about 55% smaller than our U.FL Series connector and only uses 3.4mm² of PCB space. The PCB layout for the W.FL Series is the same as for W.FL2 and X.FL Series.

Note: This product is not compatible with W.FL2 Series and X.FL Series. (Fig.1)

3. Extremely light weight

Receptacle: 5.6 mg

Right-angle plug: 18.6 mg(040), 28.2mg(062)

4. Frequency range up to 6 GHz

DC to 3 GHz : V.S.W.R. of 1.3 max.

3 GHz to 6 GHz: V.S.W.R. of 1.4 max.

5. Automatic board placement

Packaged on tape-and-reel the receptacles can be placed with vacuum nozzles of the automatic placement equipment.

6. Plugs are terminated with ultra-fine coaxial (fluorinated resin insulated) cable

The use of ultra-fine coaxial (fluorinated resin insulated) cables on these connectors offer the ability to complete connections in small, confined spaces with a smooth, easy operation.

7. Simple connector mating / unmating

Use of the available mating/un-mating tools assures correct connection/disconnection of the plug and receptacle.

8. Halogen-free*(Receptacle, Plug(HF type))

*As defined by IEC61249-2-21

Br-900ppm maximum, Cl-900 ppm maximum, Cl+Br combined-1,500 ppm maximum

■ Applications

Mobile phones, wireless communication devices, electronic measuring instruments, GPS, wireless LAN, Bluetooth and any application requiring high frequency transmission using small coaxial connectors.

Mated height comparison

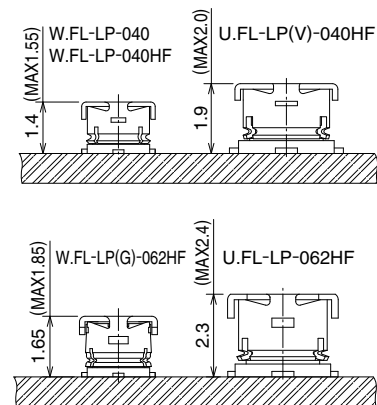

Fig.2

W. FL Plug and Receptacle

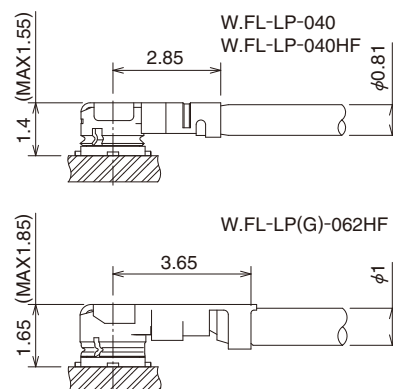
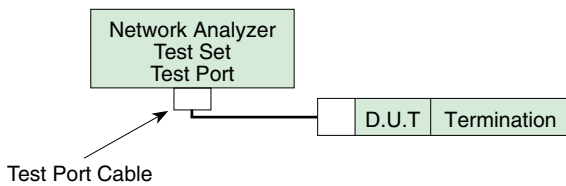

Fig.3

Specifications

Rating	Nominal characteristic impedance	50 ohms	Operating temperature range	-40°C to +90°C (90% RH max.)
	Frequency range	DC to 6 GHz	Storage temperature range	-30°C to +70°C (90% RH max.)
Item	Specification		Conditions	
1. Contact resistance	Center contact: 20m ohms max. Outer contact: 10m ohms max.		10mA max.	
2. Insulation resistance	500M ohms min.		100V DC	
3. Withstanding voltage	No flashover or insulation breakdown		200V AC / 1 minute	
4. V.S.W.R.*	1.3 Max. 1.4 Max.		Up to 3 GHz 3 to 6 GHz	

*V.S.W.R. Measurement System
Measured as shown on the block diagram below.



Note1: Measurement way of a W.FL Cable assembly (plug)
W.FL Cable assembly (plug) is measured with SMA conversion adapters mated with W.FL plugs at both ends of a 100cm coaxial cable harness

Note2: Measurement way of a W.FL receptacle
W.FL receptacle, which is mounted on a 50 ohms glass epoxy board, is measured with a SMA conversion adapter.

Materials

●Plug – right angle

Part	Material	Finish / Remarks
Shell	Phosphor bronze	Silver plated
Female center contact	Phosphor bronze	Gold plated
Insulator	PBT	Color: Black, UL94V-0(040)
		Color: Gray, UL94V HB(040HF, 062HF)

●Receptacle

Part	Material	Finish / Remarks
Shell	Phosphor bronze	Silver plated
Insulator	LCP	Color: Black, UL94V-0
Male center contact	Brass	Gold plated

Cable Assembly(Plug)

W.FL-LP-040(06), W.FL-LP-040HF(06) (Applicable cable: outer diameter 0.81)

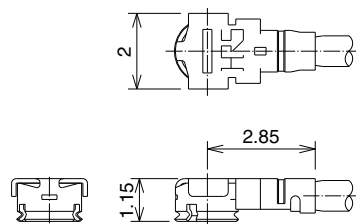

W.FL-LP-062HF(06) (Applicable cable: outer diameter 1.0)

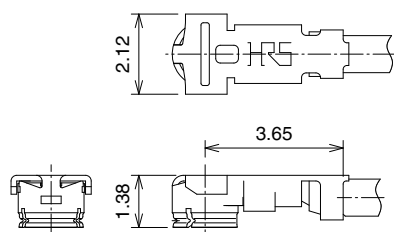

[Plugs can be ordered only as terminated cable assemblies.]

◆How to Specify Cable Assembly

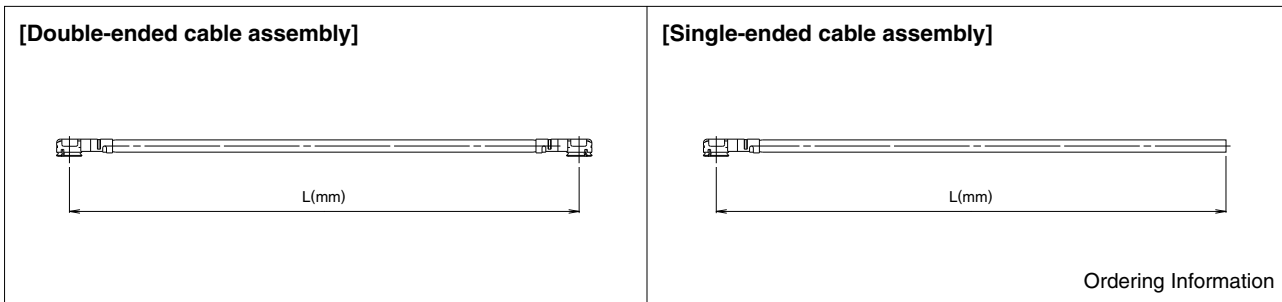

●Ordering Information

Used plug:W.FL-LP-040(06), W.FL-LP-040HF(06) (Dia. 0.81)

Double-Ended

W.FL - 2LP HF6 - 04N [] TV - A - L

① ② ③ ④ ⑤ ⑥ ⑦

Single-Ended

W.FL - LP HF6 - 04N [] TV - A - L

① ② ③ ④ ⑤ ⑥ ⑦

① Series name	W.FL
② Assembly type	LP : Single ended 2LP : Double ended
③ Environmental compliant	HF6 : Halogen-free 6 : RoHS compliant
④ Cable type	04N : 0.81mm dia. ultra-fine coaxial cable
⑤ Cable Color	1 : White 2 : Black
⑥ Cable outer conductor	TV : Tin plated braided wire
⑦ Total length(mm)	Length(L)

Used plug:W.FL-LP(G)-062HF(06) (Dia. 1)

Double-Ended

W.FL - 2LPG HF - 062N [] D - A - L

① ② ③ ④ ⑤ ⑥ ⑦

Single-Ended

W.FL - LPG HF - 062N [] D - A - L

① ② ③ ④ ⑤ ⑥ ⑦

① Series name	W.FL
② Assembly type	LPG : Single ended 2LPG : Double ended
③ Environmental compliant	HF : Halogen-free
④ Cable type	062N: 1.0mm dia. ultra-fine coaxial cable
⑤ Cable Color	1 : Gray 2 : Black 3 : White
⑥ Cable outer conductor	D : Copper tape + Outer tin plated braided wire
⑦ Total length(mm)	Length(L)

●Standard tolerances for (L)

(L)mm	Standard tolerance(mm)
*L=35 to 200	±4
L=200 to 500	±8
L=500 to 1000	±12
L=Longer than 1000	±1.5% of (L)

Note: Minimum available length(L) is 35mm.

Receptacle

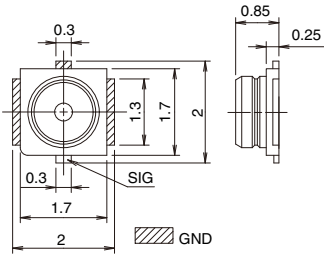
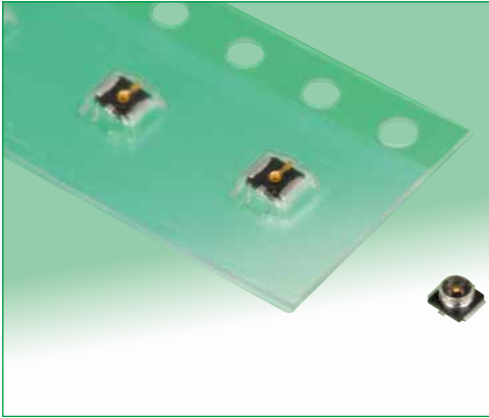

Recommended PCB mounting pattern

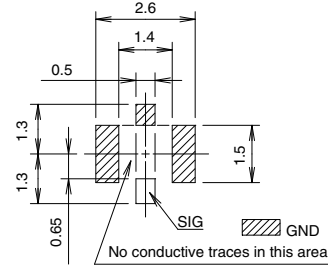

Note: The land pattern is the same as that of the X.FL, W.FL2 series connectors.

All dimensions: mm

Part No.	HRS No.	Packaging	RoHS
W.FL-R-SMT-1(60)	331-0482-6 60	Reel (5,000 pcs/reel)	Yes
W.FL-R-SMT-1(80)	331-0482-6 80	Reel (10,000 pcs/reel)	

Embossed Carrier Tape Dimensions (IEC 60286-3 compliant)

Embossed Carrier Tape Dimensions

(W.FL-R-SMT-1(60) 8mm pitch)

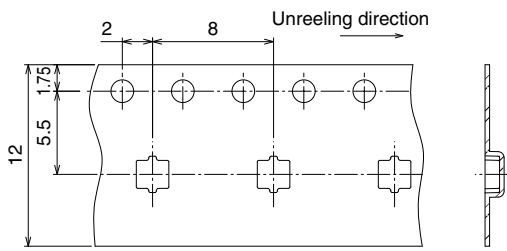

(W.FL-R-SMT-1(80) 4mm pitch)

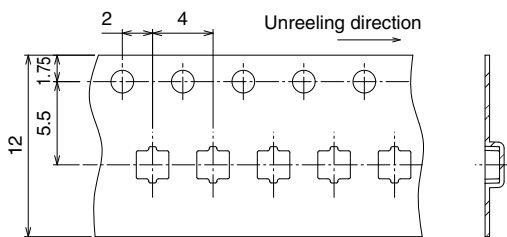

Reel Dimensions

Material : PS(Black)

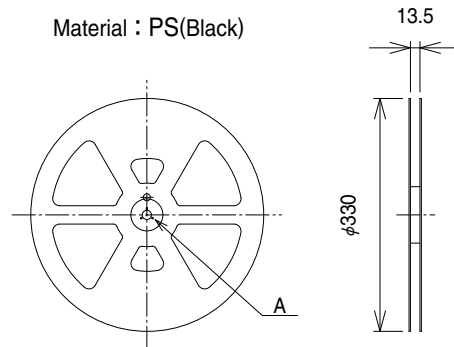

A(SCALE FREE)

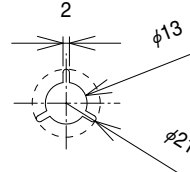

■ Conversion Adapters

● SMA Conversion Adapter (W.FL side jack – SMA side plug)

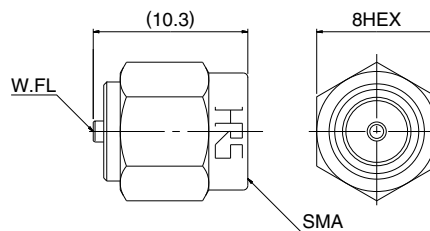

Note:Used for performance measurements only.
The W.FL mating side has lower retention force than the regular product when mated to the corresponding part.

Part No.	HRS No.	Packaging	RoHS
HRMP-W.FLJ(40)	311-0367-3 40	1	Yes

● SMA Conversion Adapter (W.FL side plug – SMA side jack)

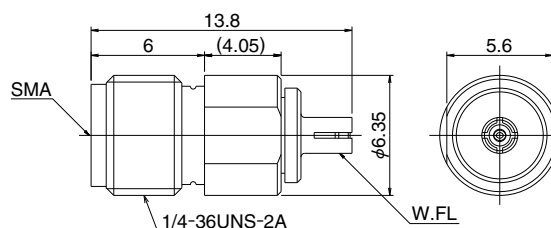

Note:Used for performance measurements only.
The W.FL mating side has lower retention force than the regular product when mated to the corresponding part.

Part No.	HRS No.	Packaging	RoHS
HRMJ-W.FLP(40)	311-0368-6 40	1	Yes

● SMA Conversion Adapter

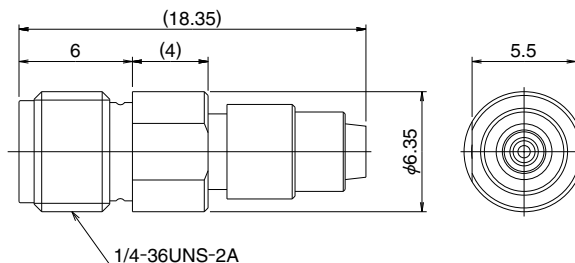

Note:When mating with corresponding part (W.FL-R-SMT-1) it must be pressed down and held to make complete connection.

Part No.	HRS No.	Packaging	RoHS
HRMJ-W.FLP-ST1(40)	311-0386-8 40	1	Yes

■ Receptacle Inspection Adapter

Used for inspecting the performance parameters of the cable assembly.

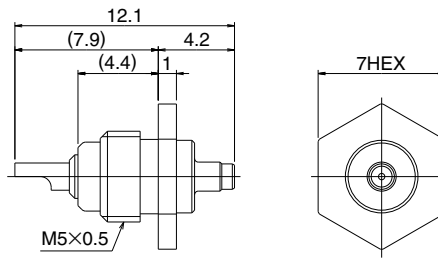
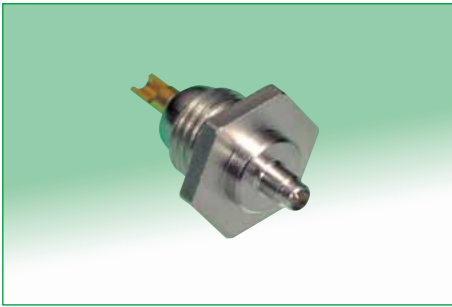

Part No.	HRS No.	Packaging	RoHS
W.FL-R-1	331-0483-9	1	Yes

◆ Plug-Mating Tool

This tool is used for mating a plug.

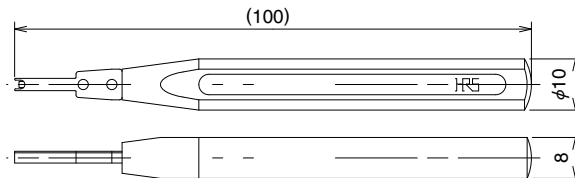

Part No.	HRS No.	Packaging	RoHS
W.FL-LP-IN	331-0323-2	1	Yes

◆ Plug-Extraction Tool

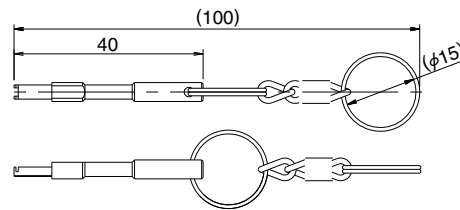
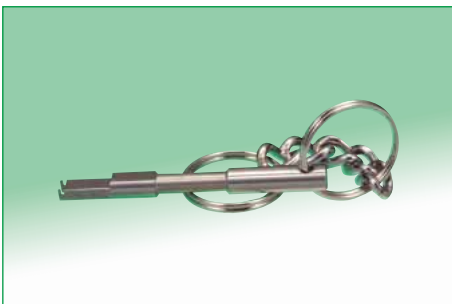

Part No.	HRS No.	Packaging	RoHS
W.FL-LP-N	331-0492-0	1	Yes

◆ Precautions

1. Plug

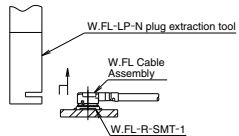
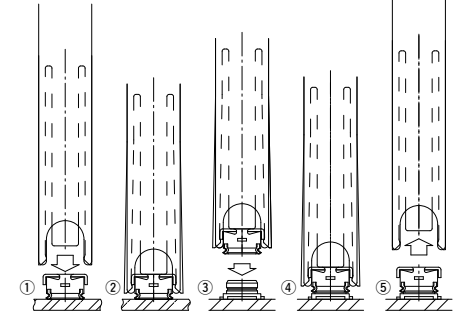
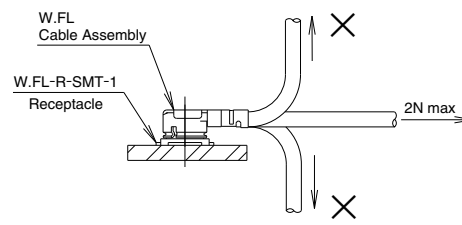
<p>(1) Mating / unmating</p>	<p>• Unmating Insert both ends of the extraction tool under the plug (from the direction opposite to the Cable termination), as shown and pull-up in the direction perpendicular to the mounting surface of the receptacle.</p> <p>● Recommended the use of the extraction tool for unmating. Any attempt of unmating by pulling on the cable may result in damage and affect the mechanical / electrical performance.</p>  <p>• Mating</p> <ol style="list-style-type: none"> Align the mating tool W.FL-LP-IN or the mating end of the tool over the plug end of the cable assembly. Firmly place the tool over the plug until it is secured in the tool. Place the plug cable assembly (held in the tool) over the corresponding receptacle. Assuring that the plug and receptacle are aligned press-down perpendicular to the mounting surface until both connectors are fully mated. Remove the mating tool by carefully pulling it up. Removal of the tool.  <p>Plug pickup → Insertion to a receptacle → Removal of the tool</p>
<p>(2) Pull forces on the cable after connectors are mated</p>	<p>After the connectors are mating, do not apply a load to the cable in excess of the values indicated in the diagram.</p> 
<p>(3) Precautions</p>	<p>Do not twist connectors excessively during mating / unmating.</p>

2. Receptacle

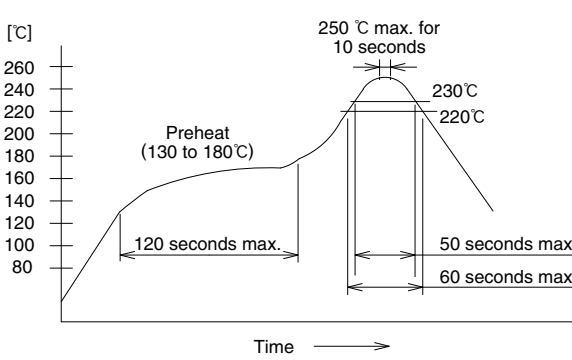
<p>(1) Recommended reflow temperature profile</p>	 <ol style="list-style-type: none"> The temperature of the printed circuit board surface temperature at the points of contact with the terminals. Reflow soldering should be performed at a printed circuit surface temperature of 250°C max. In individual applications the actual temperature may vary, depending on the solder paste type, volume / thickness and board size / thickness. Consult your solder paste and equipment manufacturer for specific recommendations.
<p>(2) Recommended metal mask thickness</p>	<p>0.1 mm to 0.12 mm</p>
<p>(3) Reflow cycles</p>	<p>2 times</p>

3. Operating environment and storage conditions

<p>(1) Operating environment</p>	<p>The connectors are not designed to operate in the following environments:</p> <ul style="list-style-type: none"> Exposed to a excessive amounts of fine particles and dust Regions and places having a high density of sulfur dioxide, hydrogen sulfide, nitrogen dioxide or other corrosive gasses. Environments having large rapid variations in temperature.
<p>(2) Storage conditions - Receptacle</p>	<p>Store in the Hirose Electric packaging. Temperature: -10 to +40°C, Humidity: 85% max. Use within 6 months of delivery. Receptacles for which the storage period has elapsed must be tested for solderability to the PC board mounting surface.</p>

Jan.1.2018 Copyright 2018 HIROSE ELECTRIC CO., LTD. All Rights Reserved.

USA:

HIROSE ELECTRIC (U.S.A.), INC. HEADQUARTERS
 2688 Westhills Court, Simi Valley, CA 93065-6235
 Phone : +1-805-522-7958
 Fax : +1-805-522-3217
<http://www.hirose.com/us/>

USA:

HIROSE ELECTRIC (U.S.A.), INC. SAN JOSE OFFICE
 3255 Scott Boulevard, Building 7, Suite 101
 Santa Clara, CA 95054
 Phone : +1-408-253-9640
 Fax : +1-408-253-9641
<http://www.hirose.com/us/>

USA:

HIROSE ELECTRIC (U.S.A.), INC. CHICAGO OFFICE
 580 Waters Edge Lane, Suite 205 Lombard IL
 60148
 Phone : +1-630-282-6706
 Mail : inquiries@hirose.com
<http://www.hirose.com/us/>

USA:

HIROSE ELECTRIC (U.S.A.), INC. DETROIT OFFICE (AUTOMOTIVE)
 37677 Professional Center Drive, Suite #100C
 Livonia, MI 48154
 Phone : +1-734-542-9963
 Fax : +1-734-542-9964
<http://www.hirose.com/us/>

THE NETHERLANDS:

HIROSE ELECTRIC EUROPE B.V.
 Hogehillweg #8 1101 CC Amsterdam Z-0
 Phone : +31-20-6557460
 Fax : +31-20-6557469
<http://www.hirose.com/eu/>

GERMANY:

HIROSE ELECTRIC EUROPE B.V. GERMAN BRANCH
 Herzog-Carl-Strasse 4 D-73760 Ostfildern
 (Scharnhäuser Park)
 Phone : +49-711-4560-02-1
 Fax : +49-711-4560-02-299
<http://www.hirose.com/eu/>

GERMANY:

HIROSE ELECTRIC EUROPE B.V. NUERNBERG OFFICE
 Muggenhofer Str. 136 90429 Nuernberg
 Phone : +49-911 32 68 89 63
 Fax : +49-911 32 68 89 69
<http://www.hirose.com/eu/>

UNITED KINGDOM:

HIROSE ELECTRIC EUROPE BV (UK BRANCH)
 4 Newton Court, Kelvin Drive, Knowlhill,
 Milton Keynes, MK5 8NH
 Phone : +44-1908 202050
 Fax : +44-1908 202058
<http://www.hirose.com/eu/>

CHINA:

HIROSE ELECTRIC (SHANGHAI) CO., LTD.
 1601, Henderson Metropolitan, NO.300, East Nanjing
 Road, Huangpu District, Shanghai, China 200001
 Phone : +86-21-6391-3355
 Fax : +86-21-6391-3335
<http://www.hirose.com/cn/>

CHINA:

HIROSE ELECTRIC (SHANGHAI) CO.,LTD. BEIJING BRANCH
 A1001, Ocean International Center, Building 56# East 4th
 Ring Middle Road, ChaoYang District, Beijing, 100025
 Phone : +86-10-5165-9332
 Fax : +86-10-5908-1381
<http://www.hirose.com/cn/>

CHINA:

HIROSE ELECTRIC TECHNOLOGIES (SHENZHEN) CO., LTD.
 Room 09-13, 19/F, Office Tower Shun Hing Square, Di Wang Commercial Centre,
 5002 Shen Nan Dong Road, Shenzhen City, Guangdong Province, 518008
 Phone : +86-755-8207-0851
 Fax : +86-755-8207-0873
<http://www.hirose.com/cn/>

HONG KONG:

HIROSE ELECTRIC HONGKONG TRADING CO., LTD.
 Room 1001, West Wing, Tsim Sha Tsui Centre, 66
 Mody Road, Tsim Sha Tsui East, Kowloon, Hong Kong
 Phone : +852-2803-5338
 Fax : +852-2591-6560
<http://www.hirose.com/hk/>

TAIWAN:

HIROSE ELECTRIC TAIWAN CO., LTD.
 103 8F, No.87, Zhengzhou Rd., Taipei
 Phone : +886-2-2555-7377
 Fax : +886-2-2555-7350
<http://www.hirose.com/cn/>

KOREA:

HIROSE KOREA CO., LTD.
 1261-10, Jeoungwhang-Dong, Shihung-City,
 Kyunggi-Do 429-450
 Phone : +82-31-496-7000,7124
 Fax : +82-31-496-7100
<http://www.hirose.co.kr/>

SINGAPORE:

HIROSE ELECTRIC SINGAPORE PTE. LTD.
 10 Anson Road #26-1, International Plaza
 079903, Singapore
 Phone : +65-6324-6113
 Fax : +65-6324-6123
<http://www.hirose.com/sg/>

INDIA:

HIROSE ELECTRIC SINGAPORE PTE. LTD. DELHI LIAISON OFFICE
 Office NO.519, Regus-Green Boulevard, Level5, Tower C,
 Sec62, Plot B-9A, Block B, Noida, 201301, Uttar Pradesh, India
 Phone : +91-12-660-8018
 Fax : +91-120-4804949
<http://www.hirose.com/sg/>

INDIA:

HIROSE ELECTRIC SINGAPORE PTE. LTD. BANGALORE LIAISON OFFICE
 Unit No.03, Ground Floor, Explorer Building International Tech
 Park Whitefield Road, Bangalore 560066 Karnataka, India
 Phone : +91-80-4120 1907
 Fax : +91-80-4120 9908
<http://www.hirose.com/sg/>

MALAYSIA:

HIROSE ELECTRIC SINGAPORE PTE. LTD. (REPRESENTATIVE OFFICE)
 1-10-07, Suntech @ Penang Cybercity (1164),Lintang
 Mayang Pasir 3,11950, Bayan Baru, Penang, Malaysia.
 Phone : +604-619-2564
 Fax : +604-619-2574
<http://www.hirose.com/sg/>



HIROSE ELECTRIC CO.,LTD.

2-6-3,Nakagawa Chuoh,Tsuzuki-Ku,Yokohama-Shi 224-8540,JAPAN
 TEL: +81-45-620-3526 Fax: +81-45-591-3726
<http://www.hirose.com>
<http://www.hirose-connectors.com>

Mouser Electronics

Authorized Distributor

Click to View Pricing, Inventory, Delivery & Lifecycle Information:

Hirose Electric:

[W.FL-LP-04N1-A-\(800\)](#) [W.FL-2LP-04N1-A-\(400\)](#) [W.FL-LP-04N1-A-\(90\)](#) [W.FL-LP-04N1-A-\(60\)](#) [W.FL-LP-04N1-A-\(80\)](#)
[W.FL-LP-04N1-A-\(40\)](#) [W.FL-2LP-04N1-A-\(180\)](#) [W.FL-LP-04N1-A-\(70\)](#) [W.FL-2LP-04N1-A-\(800\)](#) [W.FL-LP-04N1-A-](#)
[\(190\)](#) [W.FL-LP-04N1-A-\(110\)](#) [W.FL-LP-04N1-A-\(400\)](#) [W.FL-LP-04N1-A-\(210\)](#) [W.FL-2LP-04N1-A-\(240\)](#) [W.FL-2LP-](#)
[04N1-A-\(220\)](#) [W.FL-2LP-04N1-A-\(260\)](#) [W.FL-LP-04N1-A-\(50\)](#) [W.FL-LP-04N1-A-\(250\)](#) [W.FL-LP-04N1-A-\(35\)](#) [W.FL-](#)
[LP-04N1-A-\(260\)](#) [W.FL-LP-04N1-A-\(220\)](#) [W.FL-LP-04N1-A-\(200\)](#) [W.FL-2LP-04N1-A-\(600\)](#) [W.FL-LP-04N1-A-\(150\)](#)
[W.FL-2LP-04N1-A-\(110\)](#) [W.FL-LP-04N1-A-\(900\)](#) [W.FL-2LP-04N1-A-\(150\)](#) [W.FL-2LP-04N1-A-\(130\)](#) [W.FL-2LP-04N1-](#)
[A-\(170\)](#) [W.FL-2LP-04N1-A-\(160\)](#) [W.FL-2LP-04N1-A-\(120\)](#) [W.FL-2LP-04N1-A-\(290\)](#) [W.FL-2LP-04N1-A-\(900\)](#) [W.FL-](#)
[LP-04N1-A-\(130\)](#) [W.FL-LP-04N1-A-\(170\)](#) [W.FL-2LP-04N1-A-\(190\)](#) [W.FL-LP-04N1-A-\(140\)](#) [W.FL-LP-04N1-A-\(100\)](#)
[W.FL-LP-04N1-A-\(180\)](#) [W.FL-LP-04N1-A-\(160\)](#) [W.FL-LP-04N1-A-\(120\)](#) [W.FL-2LP-04N1-A-\(200\)](#) [W.FL-LP-04N1-A-](#)
[\(600\)](#) [W.FL-2LP-04N1-A-\(230\)](#) [W.FL-2LP-04N1-A-\(270\)](#) [W.FL-LP-IN](#) [W.FL-2LP-04N1-A-\(280\)](#) [W.FL-2LP-04N1-A-](#)
[\(140\)](#) [W.FL-LP-04N1-A-\(700\)](#) [W.FL-2LP-04N1-A-\(300\)](#) [W.FL-LP-04N1-A-\(300\)](#) [W.FL-2LP-04N1-A-\(700\)](#) [W.FL-LP-](#)
[04N1-A-\(500\)](#) [W.FL-2LP-04N1-A-\(60\)](#) [W.FL-2LP-04N2-A-\(90\)](#) [W.FL-2LP-04N2-A-\(70\)](#) [W.FL-2LP-04N2-A-\(40\)](#) [W.FL-](#)
[2LP-04N1-A-\(80\)](#) [W.FL-2LP-04N1-A-\(40\)](#) [W.FL-2LP-04N1-A-\(50\)](#) [W.FL-2LP-04N2-A-\(35\)](#) [W.FL-2LP-04N2-A-\(50\)](#)
[W.FL-2LP-04N2-A-\(60\)](#) [W.FL-2LP-04N2-A-\(80\)](#) [W.FL-2LP-04N1-A-\(250\)](#) [W.FL-2LP-04N1-A-\(70\)](#) [W.FL-2LP-04N1-A-](#)
[\(90\)](#) [W.FL-LP-04N1-A-\(1000\)](#) [W.FL-2LP-04N2-A-\(300\)](#) [W.FL-2LP-04N2-A-\(130\)](#) [W.FL-2LP-04N2-A-\(700\)](#) [W.FL-2LP-](#)
[04N2-A-\(150\)](#) [W.FL-2LP-04N2-A-\(110\)](#) [W.FL-2LP-04N2-A-\(190\)](#) [W.FL-2LP-04N2-A-\(170\)](#) [W.FL-2LP-04N1-A-\(35\)](#)
[W.FL-2LP-04N2-A-\(1000\)](#) [W.FL-2LP-04N2-A-\(180\)](#) [W.FL-2LP-04N2-A-\(600\)](#) [W.FL-2LP-04N2-A-\(400\)](#) [W.FL-2LP-](#)
[04N2-A-\(800\)](#) [W.FL-2LP-04N2-A-\(140\)](#) [W.FL-2LP-04N2-A-\(120\)](#) [W.FL-2LP-04N2-A-\(160\)](#) [W.FL-2LP-04N2-A-\(500\)](#)
[W.FL-R-SMT-1\(40\)](#) [W.FL-2LP-04N2-A-\(200\)](#) [W.FL-2LP-04N2-A-\(900\)](#) [W.FL-2LP-04N1-A-\(100\)](#) [W.FL-2LP-04N1-A-](#)
[\(1000\)](#) [W.FL-2LP-04N1-A-\(500\)](#) [W.FL-2LP-04N2-A-\(100\)](#) [W.FL-2LPG-062N2D-A\(100\)](#) [W.FL-2LPG-062N2D-A\(35\)](#)
[W.FL-2LPG-062N2D-A\(40\)](#) [W.FL-2LPG-062N2D-A\(70\)](#) [W.FL-LP-N](#) [W.FL-R-1](#) [W.FL-R-SMT-1\(10\)](#) [W.FL/CR-AD\(63\)](#)