

National Semiconductor is now part of
Texas Instruments.

Search <http://www.ti.com/> for the latest technical
information and details on our current products and services.

LMP7711/LMP7712

Single and Dual Precision, 17 MHz, Low Noise, CMOS Input Amplifiers

General Description

The LMP7711/LMP7712 are single and dual low noise, low offset, CMOS input, rail-to-rail output precision amplifiers with a high gain bandwidth product and an enable pin. The LMP7711/LMP7712 are part of the LMP® precision amplifier family and are ideal for a variety of instrumentation applications.

Utilizing a CMOS input stage, the LMP7711/LMP7712 achieve an input bias current of 100 fA, an input referred voltage noise of 5.8 nV/√Hz, and an input offset voltage of less than ±150 μV. These features make the LMP7711/LMP7712 superior choices for precision applications.

Consuming only 1.15 mA of supply current, the LMP7711 offers a high gain bandwidth product of 17 MHz, enabling accurate amplification at high closed loop gains.

The LMP7711/LMP7712 have a supply voltage range of 1.8V to 5.5V, which makes these ideal choices for portable low power applications with low supply voltage requirements. In order to reduce the already low power consumption the LMP7711/LMP7712 have an enable function. Once in shutdown, the LMP7711/LMP7712 draw only 140 nA of supply current.

The LMP7711/LMP7712 are built with National's advanced VIP50 process technology. The LMP7711 is offered in a 6-pin TSOT23 package and the LMP7712 is offered in a 10-pin MSOP.

Features

Unless otherwise noted, typical values at $V_S = 5V$.

- Input offset voltage ±150 μV (max)
- Input bias current 100 fA
- Input voltage noise 5.8 nV/√Hz
- Gain bandwidth product 17 MHz
- Supply current (LMP7711) 1.15 mA
- Supply current (LMP7712) 1.30 mA
- Supply voltage range 1.8V to 5.5V
- THD+N @ $f = 1$ kHz 0.001%
- Operating temperature range -40°C to 125°C
- Rail-to-rail output swing
- Space saving TSOT23 package (LMP7711)
- 10-pin MSOP package (LMP7712)

Applications

- Active filters and buffers
- Sensor interface applications
- Transimpedance amplifiers

Typical Performance

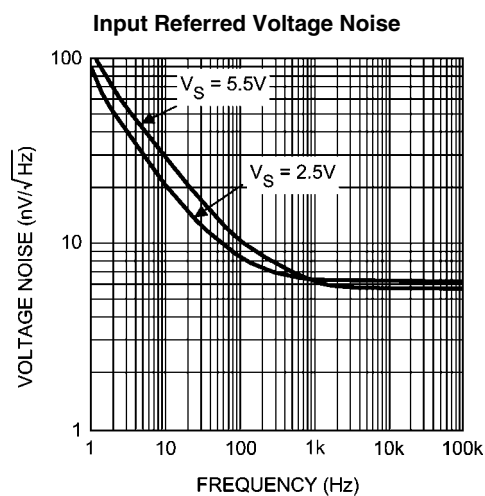
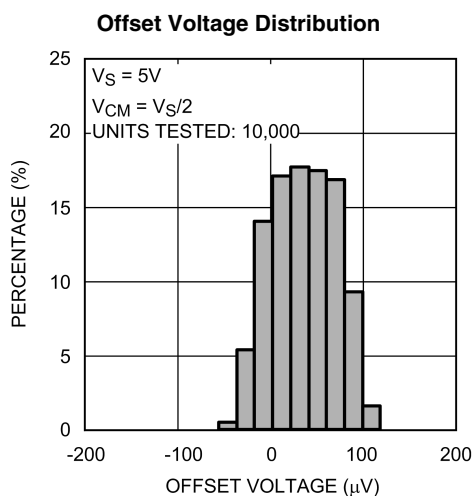

Absolute Maximum Ratings (Note 1)

If Military/Aerospace specified devices are required, please contact the National Semiconductor Sales Office/Distributors for availability and specifications.

ESD Tolerance (Note 2)	
Human Body Model	2000V
Machine Model	200V
Charge-Device Model	1000V
V_{IN} Differential	$\pm 0.3V$
Supply Voltage ($V_S = V^+ - V^-$)	6.0V
Voltage on Input/Output Pins	$V^+ + 0.3V, V^- - 0.3V$
Storage Temperature Range	$-65^\circ C$ to $150^\circ C$
Junction Temperature (Note 3)	$+150^\circ C$

Soldering Information

Infrared or Convection (20 sec)	$235^\circ C$
Wave Soldering Lead Temp. (10 sec)	$260^\circ C$

Operating Ratings (Note 1)

Temperature Range (Note 3)	$-40^\circ C$ to $125^\circ C$
Supply Voltage ($V_S = V^+ - V^-$)	
$0^\circ C \leq T_A \leq 125^\circ C$	1.8V to 5.5V
$-40^\circ C \leq T_A \leq 125^\circ C$	2.0V to 5.5V
Package Thermal Resistance (θ_{JA}) (Note 3)	
6-Pin TSOT23	$170^\circ C/W$
10-Pin MSOP	$236^\circ C/W$

2.5V Electrical Characteristics

Unless otherwise specified, all limits are guaranteed for $T_A = 25^\circ C$, $V^+ = 2.5V$, $V^- = 0V$, $V_O = V_{CM} = V^+/2$, $V_{EN} = V^+$. **Boldface** limits apply at the temperature extremes.

Symbol	Parameter	Conditions	Min (Note 5)	Typ (Note 4)	Max (Note 5)	Units
V_{OS}	Input Offset Voltage			± 20	± 180 ± 480	μV
TC V_{OS}	Input Offset Voltage Temperature Drift (Notes 6, 8)	LMP7711 LMP7712		-1 -1.75	± 4	$\mu V/^\circ C$
I_B	Input Bias Current	$V_{CM} = 1.0V$ (Notes 7, 8)		0.05	1 25	pA
		$-40^\circ C \leq T_A \leq 85^\circ C$		0.05	1 100	
I_{OS}	Input Offset Current	$V_{CM} = 1.0V$ (Note 8)		0.006	0.5 50	pA
CMRR	Common Mode Rejection Ratio	$0V \leq V_{CM} \leq 1.4V$	83 80	100		dB
PSRR	Power Supply Rejection Ratio	$2.0V \leq V^+ \leq 5.5V$ $V^- = 0V, V_{CM} = 0$	85 80	100		dB
		$1.8V \leq V^+ \leq 5.5V$ $V^- = 0V, V_{CM} = 0$	85	98		
CMVR	Common Mode Voltage Range	CMRR ≥ 80 dB CMRR ≥ 78 dB	-0.3 -0.3		1.5 1.5	V
A_{VOL}	Open Loop Voltage Gain	LMP7711, $V_O = 0.15$ to $2.2V$ $R_L = 2$ k Ω to $V^+/2$	88 82	98		dB
		LMP7712, $V_O = 0.15$ to $2.2V$ $R_L = 2$ k Ω to $V^+/2$	84 80	92		
		LMP7711, $V_O = 0.15$ to $2.2V$ $R_L = 10$ k Ω to $V^+/2$	92 88	110		
		LMP7712, $V_O = 0.15$ to $2.2V$ $R_L = 10$ k Ω to $V^+/2$	90 86	95		
V_{OUT}	Output Voltage Swing High	$R_L = 2$ k Ω to $V^+/2$		25	70 77	mV from either rail
		$R_L = 10$ k Ω to $V^+/2$		20	60 66	
	Output Voltage Swing Low	$R_L = 2$ k Ω to $V^+/2$		30	70 73	
		$R_L = 10$ k Ω to $V^+/2$		15	60 62	

Symbol	Parameter	Conditions	Min (Note 5)	Typ (Note 4)	Max (Note 5)	Units
I_{OUT}	Output Current	Sourcing to V^- $V_{IN} = 200 \text{ mV}$ (Note 9)	36 30	52		mA
		Sinking to V^+ $V_{IN} = -200 \text{ mV}$ (Note 9)	7.5 5.0	15		
I_S	Supply Current	LMP7711 Enable Mode $V_{EN} \geq 2.1$		0.95	1.30 1.65	mA
		LMP7712 (per channel) Enable Mode $V_{EN} \geq 2.1$		1.10	1.50 1.85	
		Shutdown Mode (per channel) $V_{EN} \leq 0.4$		0.03	1 4	μA
SR	Slew Rate	$A_V = +1$, Rising (10% to 90%)		8.3		$\text{V}/\mu\text{s}$
		$A_V = +1$, Falling (90% to 10%)		10.3		
GBW	Gain Bandwidth			14		MHz
e_n	Input Referred Voltage Noise Density	$f = 400 \text{ Hz}$		6.8		$\text{nV}/\sqrt{\text{Hz}}$
		$f = 1 \text{ kHz}$		5.8		
i_n	Input Referred Current Noise Density	$f = 1 \text{ kHz}$		0.01		$\text{pA}/\sqrt{\text{Hz}}$
t_{on}	Turn-on Time			140		ns
t_{off}	Turn-off Time			1000		ns
V_{EN}	Enable Pin Voltage Range	Enable Mode	2.1	2 - 2.5		V
		Shutdown Mode		0 - 0.5	0.4	
I_{EN}	Enable Pin Input Current	$V_{EN} = 2.5 \text{ V}$ (Note 7)		1.5	3.0	μA
		$V_{EN} = 0 \text{ V}$ (Note 7)		0.003	0.1	
THD+N	Total Harmonic Distortion + Noise	$f = 1 \text{ kHz}$, $A_V = 1$, $R_L = 100 \text{ k}\Omega$ $V_O = 0.9 V_{PP}$		0.003		%
		$f = 1 \text{ kHz}$, $A_V = 1$, $R_L = 600 \Omega$ $V_O = 0.9 V_{PP}$		0.004		

5V Electrical Characteristics

Unless otherwise specified, all limits are guaranteed for $T_A = 25^\circ\text{C}$, $V^+ = 5\text{V}$, $V^- = 0\text{V}$, $V_{CM} = V^+/2$, $V_{EN} = V^+$. **Boldface** limits apply at the temperature extremes.

Symbol	Parameter	Conditions	Min (Note 5)	Typ (Note 4)	Max (Note 5)	Units
V_{OS}	Input Offset Voltage			± 10	± 150 ± 450	μV
TC V_{OS}	Input Offset Voltage Temperature Drift (Notes 6, 8)	LMP7711		-1	± 4	$\mu\text{V}/^\circ\text{C}$
		LMP7712		-1.75		
I_B	Input Bias Current	$V_{CM} = 2.0\text{V}$ (Notes 7, 8)	$-40^\circ\text{C} \leq T_A \leq 85^\circ\text{C}$	0.1	1 25	pA
			$-40^\circ\text{C} \leq T_A \leq 125^\circ\text{C}$	0.1	1 100	
I_{OS}	Input Offset Current	$V_{CM} = 2.0\text{V}$ (Note 8)		0.01	0.5 50	pA
CMRR	Common Mode Rejection Ratio	$0\text{V} \leq V_{CM} \leq 3.7\text{V}$	85 82	100		dB
PSRR	Power Supply Rejection Ratio	$2.0\text{V} \leq V^+ \leq 5.5\text{V}$ $V^- = 0\text{V}$, $V_{CM} = 0$	85 80	100		dB
		$1.8\text{V} \leq V^+ \leq 5.5\text{V}$ $V^- = 0\text{V}$, $V_{CM} = 0$	85	98		

Symbol	Parameter	Conditions	Min (Note 5)	Typ (Note 4)	Max (Note 5)	Units
CMVR	Common Mode Voltage Range	CMRR \geq 80 dB CMRR \geq 78 dB	-0.3 -0.3		4 4	V
A _{VOL}	Open Loop Voltage Gain	LMP7711, V _O = 0.3 to 4.7V R _L = 2 k Ω to V ⁺ /2	88 82	107		dB
		LMP7712, V _O = 0.3 to 4.7V R _L = 2 k Ω to V ⁺ /2	84 80	90		
		LMP7711, V _O = 0.3 to 4.7V R _L = 10 k Ω to V ⁺ /2	92 88	110		
		LMP7712, V _O = 0.3 to 4.7V R _L = 10 k Ω to V ⁺ /2	90 86	95		
V _{OUT}	Output Voltage Swing High	R _L = 2 k Ω to V ⁺ /2		32	70 77	mV from either rail
		R _L = 10 k Ω to V ⁺ /2		22	60 66	
	Output Voltage Swing Low	R _L = 2 k Ω to V ⁺ /2 (LMP7711)		42	70 73	
		R _L = 2 k Ω to V ⁺ /2 (LMP7712)		50	75 78	
		R _L = 10 k Ω to V ⁺ /2		20	60 62	
I _{OUT}	Output Current	Sourcing to V ⁻ V _{IN} = 200 mV (Note 9)	46 38	66		mA
		Sinking to V ⁺ V _{IN} = -200 mV (Note 9)	10.5 6.5	23		
I _S	Supply Current	LMP7711 Enable Mode V _{EN} \geq 4.6		1.15	1.40 1.75	mA
		LMP7712 (per channel) Enable Mode V _{EN} \geq 4.6		1.30	1.70 2.05	
		Shutdown Mode V _{EN} \leq 0.4 (per channel)		0.14	1 4	μ A
SR	Slew Rate	A _V = +1, Rising (10% to 90%)	6.0	9.5		V/ μ s
		A _V = +1, Falling (90% to 10%)	7.5	11.5		
GBW	Gain Bandwidth			17		MHz
e _n	Input Referred Voltage Noise Density	f = 400 Hz		7.0		nV/ $\sqrt{\text{Hz}}$
		f = 1 kHz		5.8		
i _n	Input Referred Current Noise Density	f = 1 kHz		0.01		pA/ $\sqrt{\text{Hz}}$
t _{on}	Turn-on Time			110		ns
t _{off}	Turn-off Time			800		ns
V _{EN}	Enable Pin Voltage Range	Enable Mode	4.6	4.5 – 5		V
		Shutdown Mode		0 – 0.5	0.4	
I _{EN}	Enable Pin Input Current	V _{EN} = 5V (Note 7)		5.6	10	μ A
		V _{EN} = 0V (Note 7)		0.005	0.2	
THD+N	Total Harmonic Distortion + Noise	f = 1 kHz, A _V = 1, R _L = 100 k Ω V _O = 4 V _{PP}		0.001		%
		f = 1 kHz, A _V = 1, R _L = 600 Ω V _O = 4 V _{PP}		0.004		

Note 1: Absolute Maximum Ratings indicate limits beyond which damage to the device may occur. Operating Ratings indicate conditions for which the device is intended to be functional, but specific performance is not guaranteed. For guaranteed specifications and the test conditions, see the Electrical Characteristics Tables.

Note 2: Human Body Model, applicable std. MIL-STD-883, Method 3015.7. Machine Model, applicable std. JESD22-A115-A (ESD MM std. of JEDEC) Field-Induced Charge-Device Model, applicable std. JESD22-C101-C (ESD FICDM std. of JEDEC).

Note 3: The maximum power dissipation is a function of $T_{J(MAX)}$, θ_{JA} . The maximum allowable power dissipation at any ambient temperature is $P_D = (T_{J(MAX)} - T_A)/\theta_{JA}$. All numbers apply for packages soldered directly onto a PC Board.

Note 4: Typical values represent the most likely parametric norm as determined at the time of characterization. Actual typical values may vary over time and will also depend on the application and configuration. The typical values are not tested and are not guaranteed on shipped production material.

Note 5: Limits are 100% production tested at 25°C. Limits over the operating temperature range are guaranteed through correlations using the Statistical Quality Control (SQC) method.

Note 6: Offset voltage average drift is determined by dividing the change in V_{OS} at the temperature extremes by the total temperature change.

Note 7: Positive current corresponds to current flowing into the device.

Note 8: This parameter is guaranteed by design and/or characterization and is not tested in production.

Note 9: The short circuit test is a momentary open loop test.

Connection Diagrams

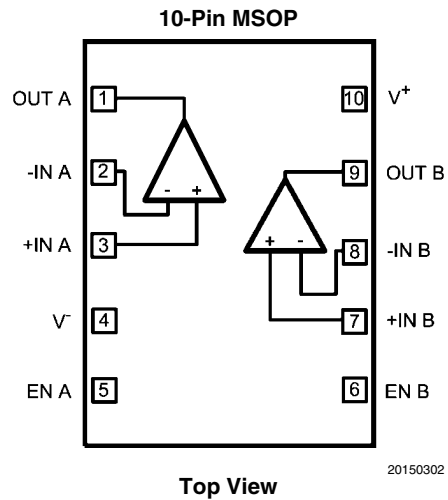
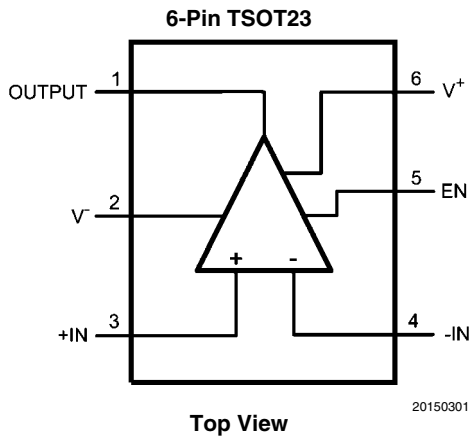

Ordering Information

Package	Part Number	Package Marking	Transport Media	NSC Drawing
6-Pin TSOT23	LMP7711MK	AC3A	1k Units Tape and Reel	MK06A
	LMP7711MKE		250 Units Tape and Reel	
	LMP7711MKX		3k Units Tape and Reel	
10-Pin MSOP	LMP7712MM	AD3A	1k Units Tape and Reel	MUB10A
	LMP7712MME		250 Units Tape and Reel	
	LMP7712MMX		3.5k Units Tape and Reel	

Typical Performance Characteristics

Unless otherwise noted: $T_A = 25^\circ\text{C}$, $V_S = 5\text{V}$, $V_{CM} = V_S/2$, $V_{EN} = V^+$.

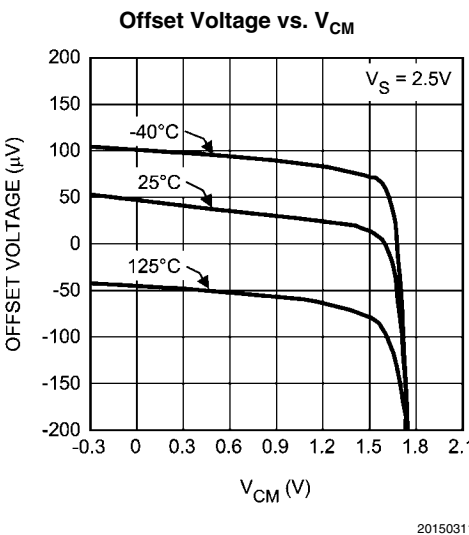
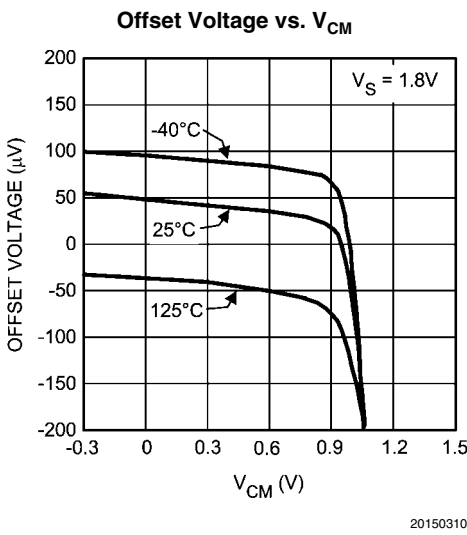
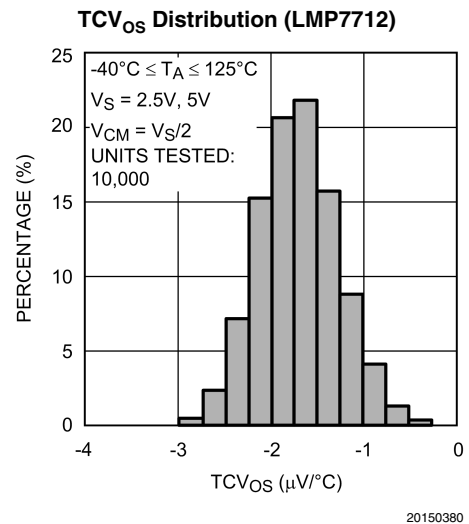
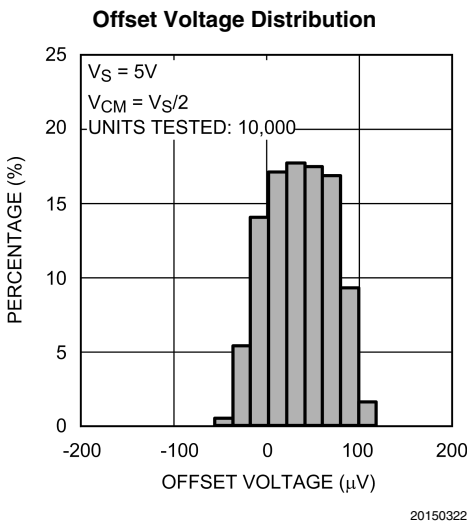
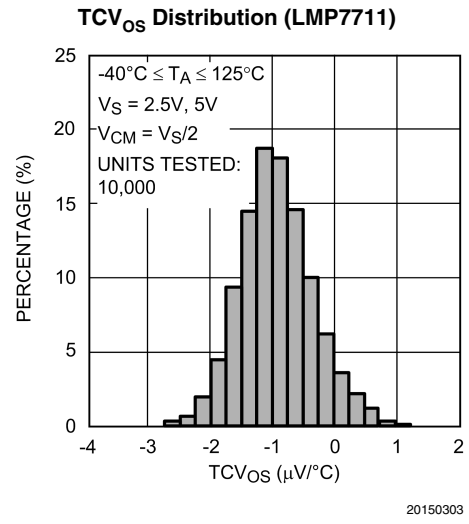
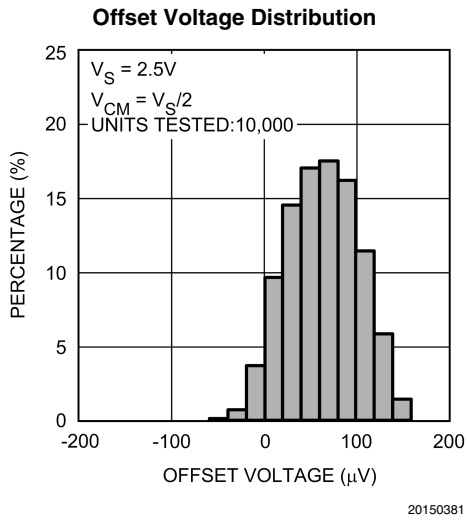

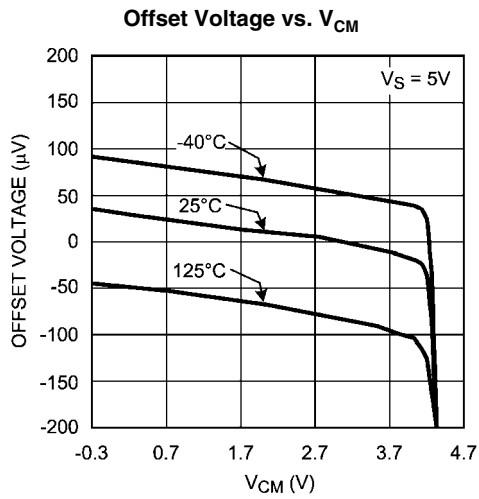

20150312

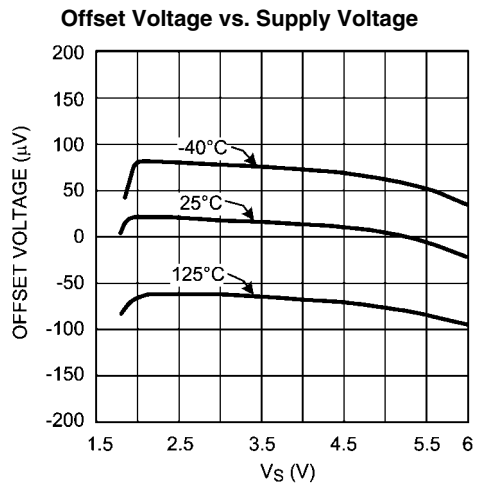

20150321

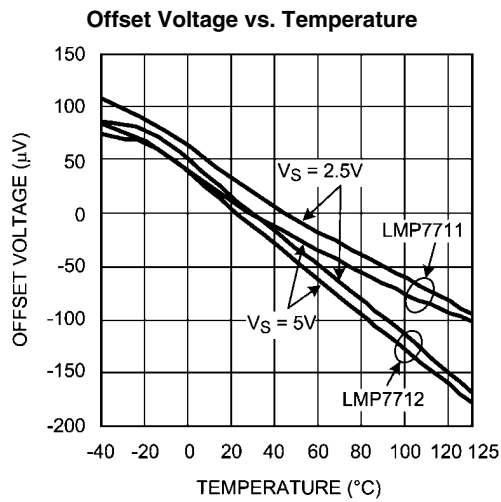

20150309

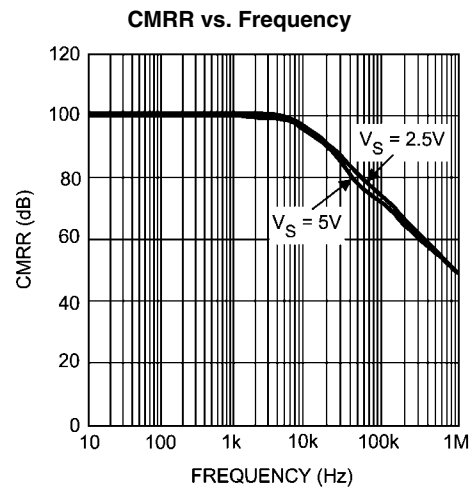

20150356

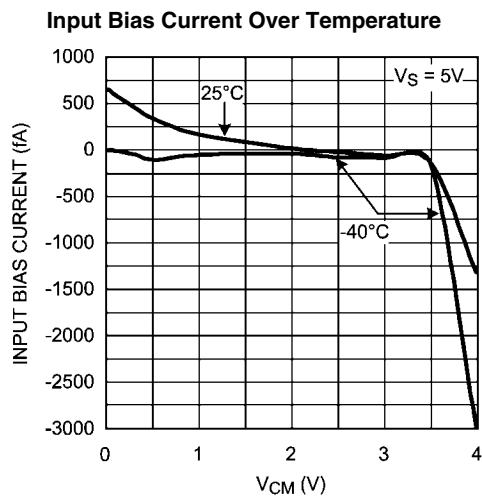

20150323

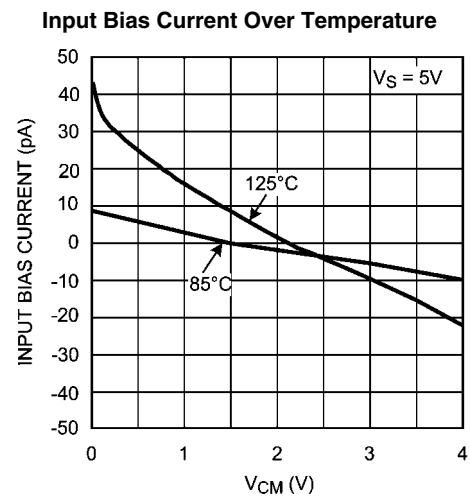

20150324

Supply Current vs. Supply Voltage (LMP7711)

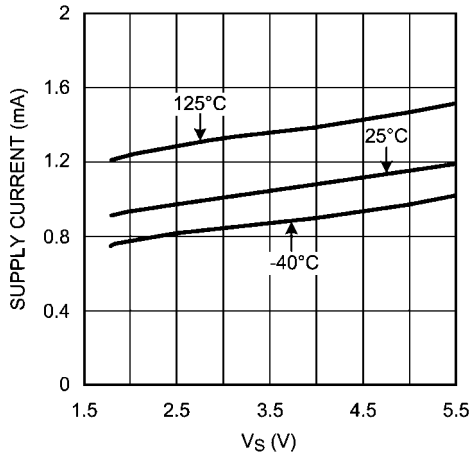

20150305

Supply Current vs. Supply Voltage (LMP7712)

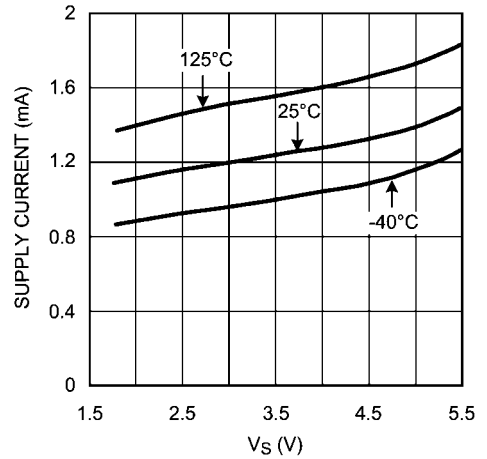

20150377

Supply Current vs. Supply Voltage (Shutdown)

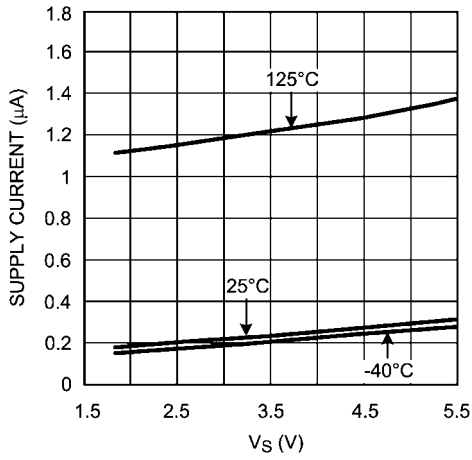

20150306

Crosstalk Rejection Ratio (LMP7712)

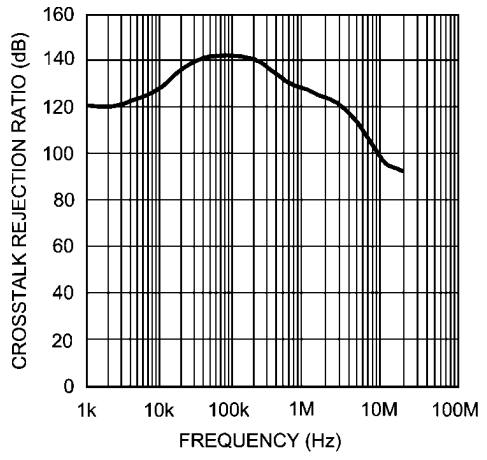

20150376

Supply Current vs. Enable Pin Voltage (LMP7711)

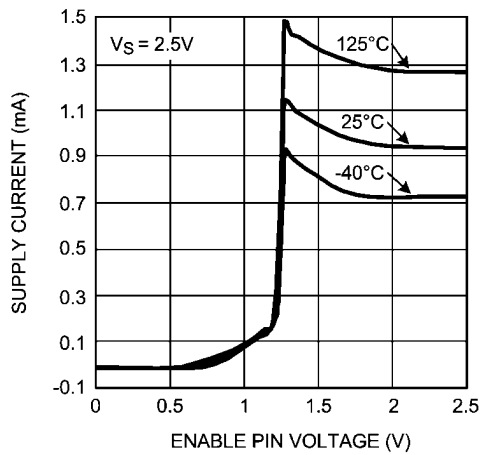

20150308

Supply Current vs. Enable Pin Voltage (LMP7711)

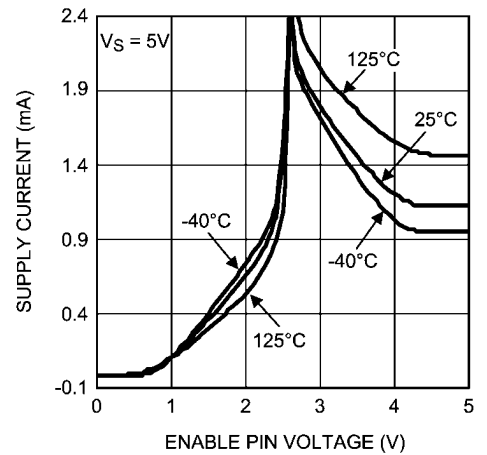

20150307

Supply Current vs. Enable Pin Voltage (LMP7712)

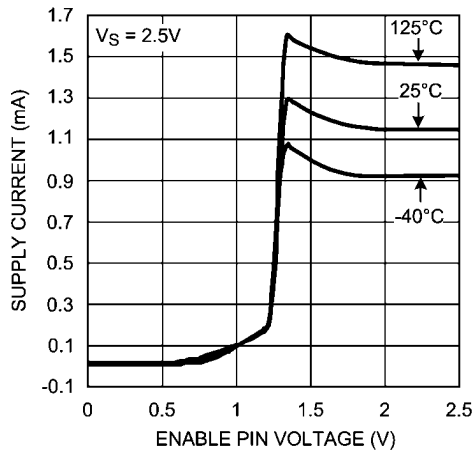

20150378

Supply Current vs. Enable Pin Voltage (LMP7712)

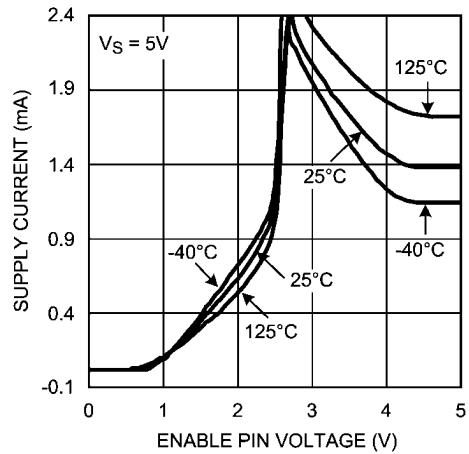

20150379

Sourcing Current vs. Supply Voltage

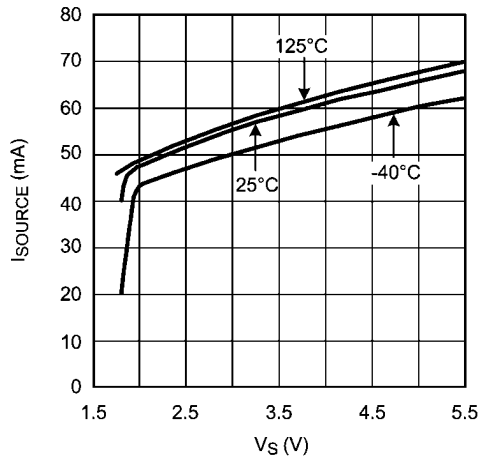

20150320

Sinking Current vs. Supply Voltage

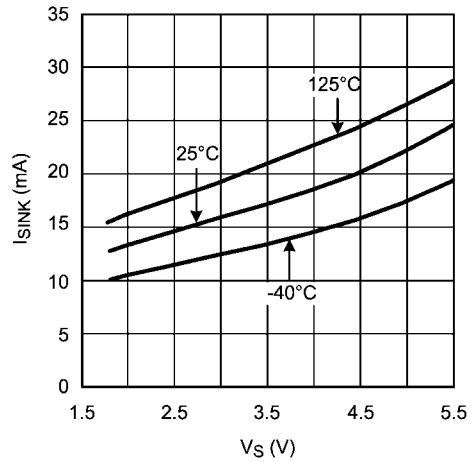

20150319

Sourcing Current vs. Output Voltage

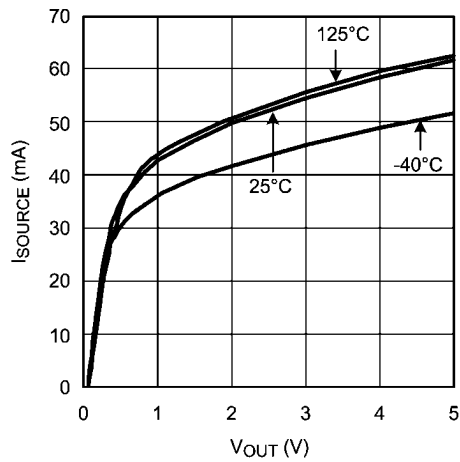

20150350

Sinking Current vs. Output Voltage

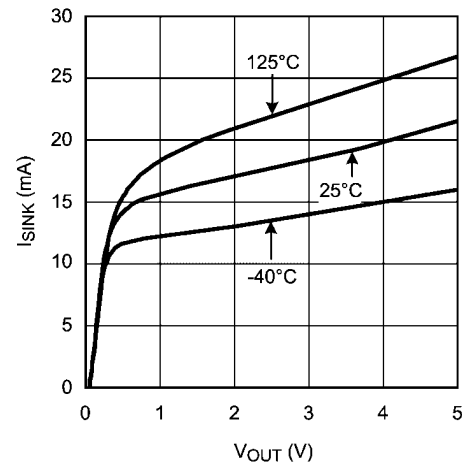

20150354

Output Swing High vs. Supply Voltage

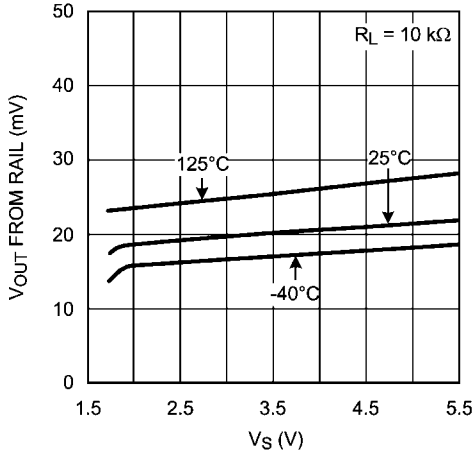

Output Swing Low vs. Supply Voltage

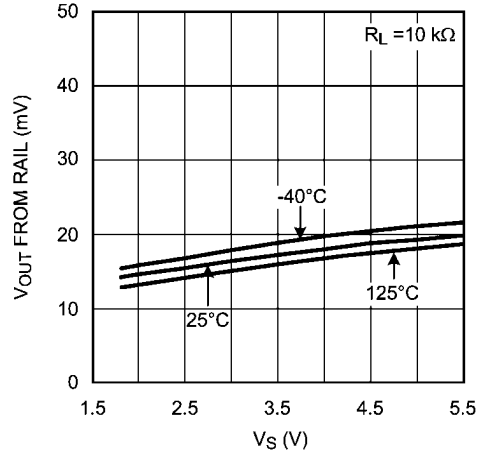

Output Swing High vs. Supply Voltage

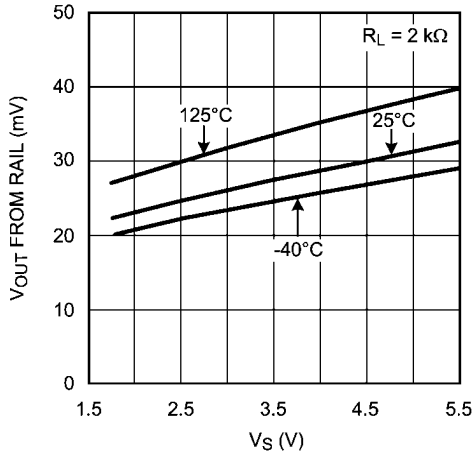

Output Swing Low vs. Supply Voltage

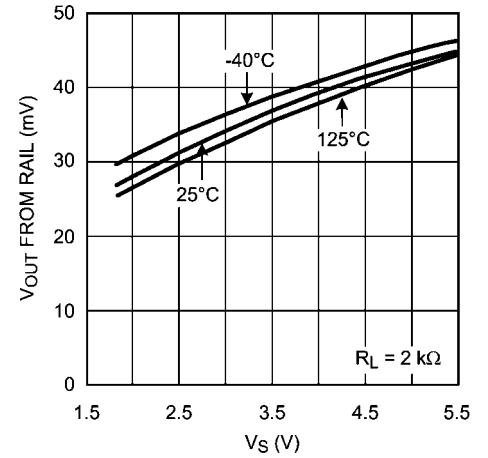

Output Swing High vs. Supply Voltage

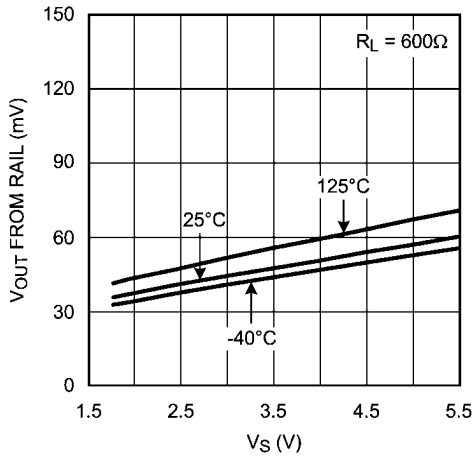

Output Swing Low vs. Supply Voltage

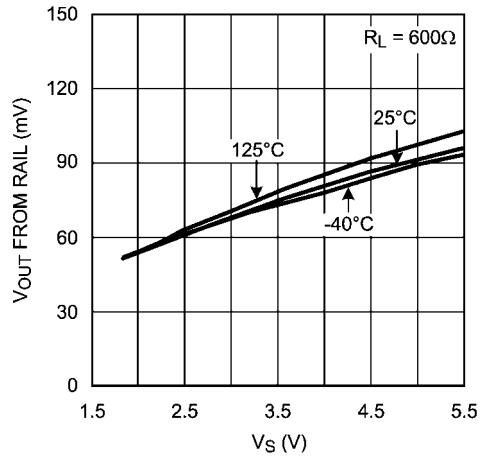

Open Loop Frequency Response

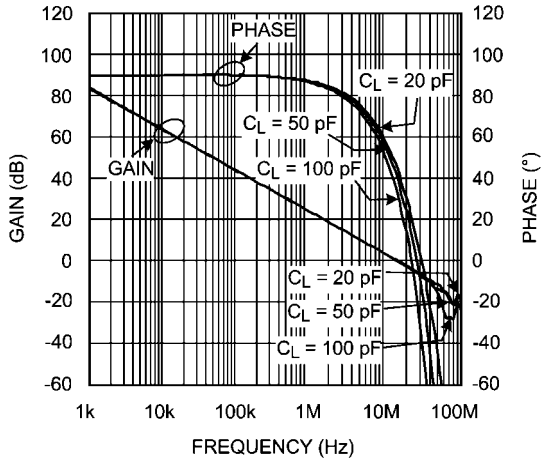

20150341

Open Loop Frequency Response

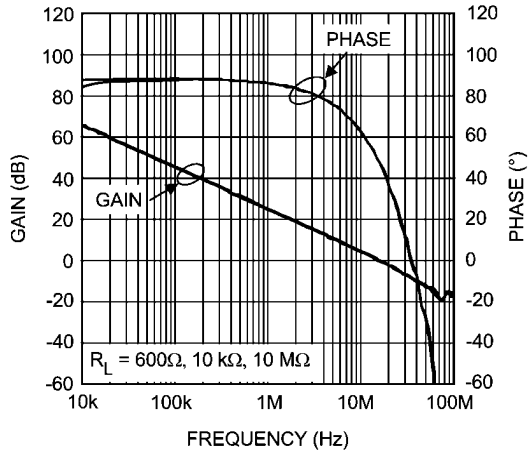

20150373

Phase Margin vs. Capacitive Load

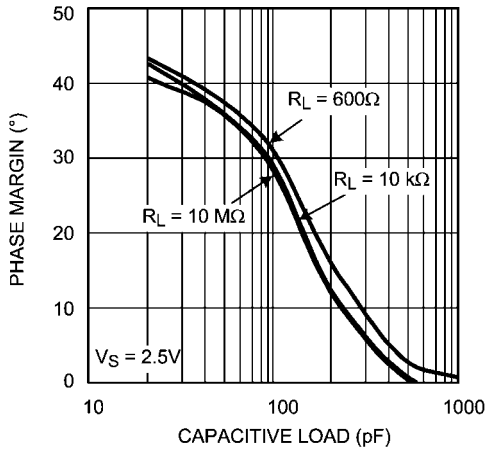

20150345

Phase Margin vs. Capacitive Load

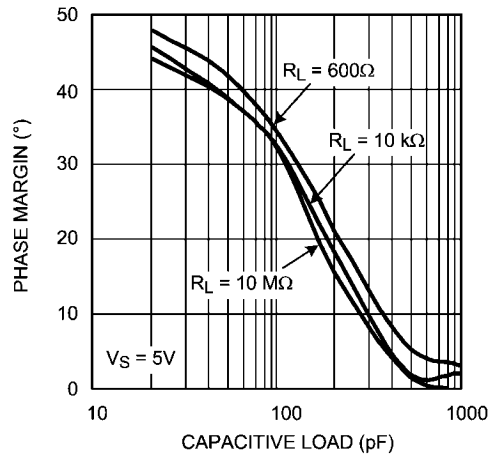

20150346

Overshoot and Undershoot vs. Capacitive Load

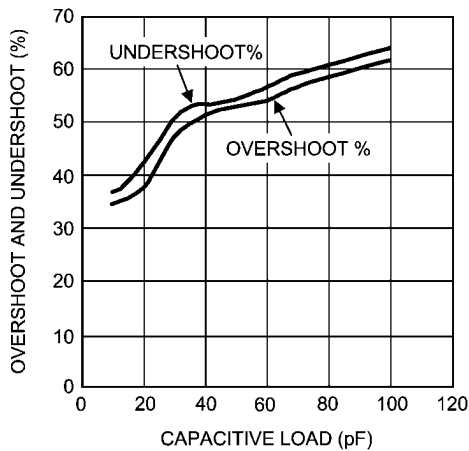

20150330

Slew Rate vs. Supply Voltage

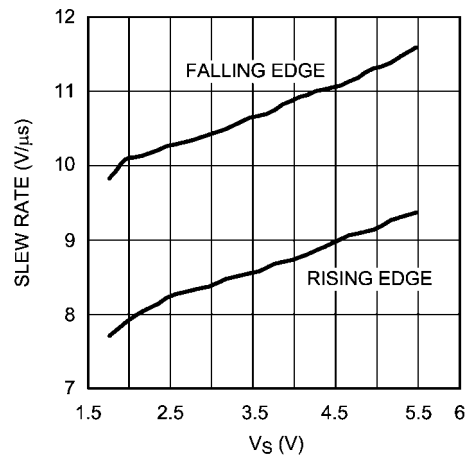

20150329

Small Signal Step Response

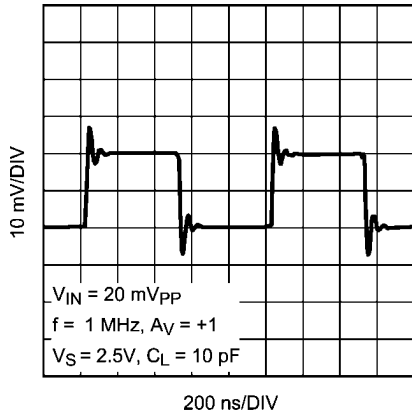

20150338

Large Signal Step Response

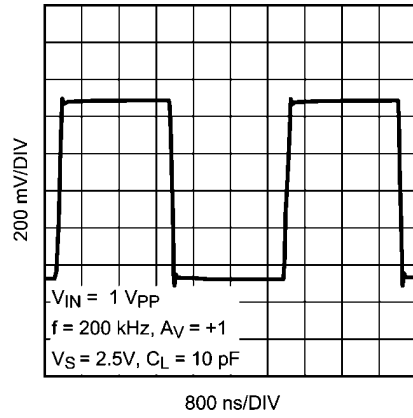

20150337

Small Signal Step Response

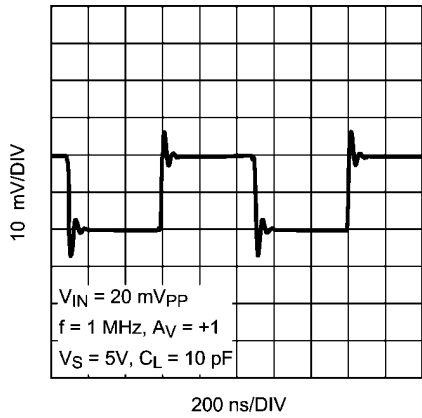

20150333

Large Signal Step Response

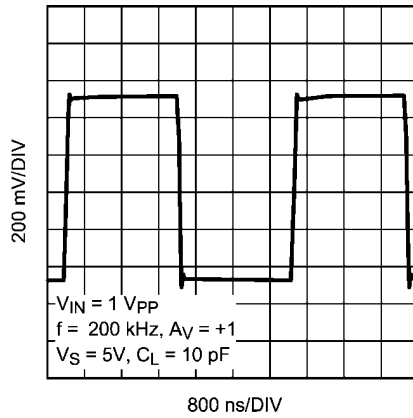

20150334

THD+N vs. Output Voltage

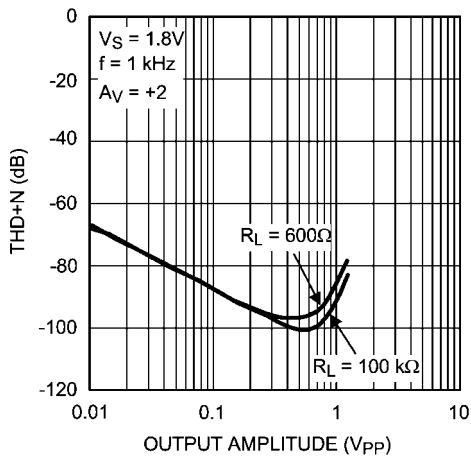

20150326

THD+N vs. Output Voltage

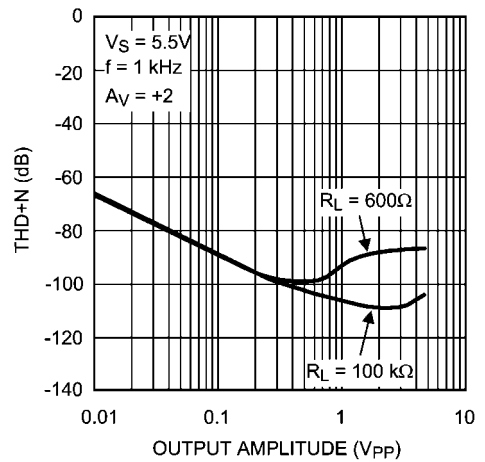

20150304

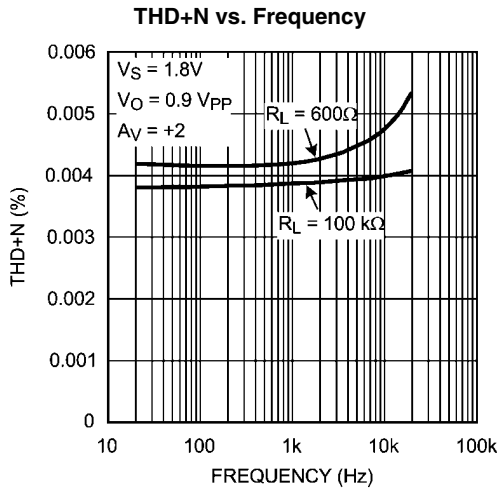

20150357

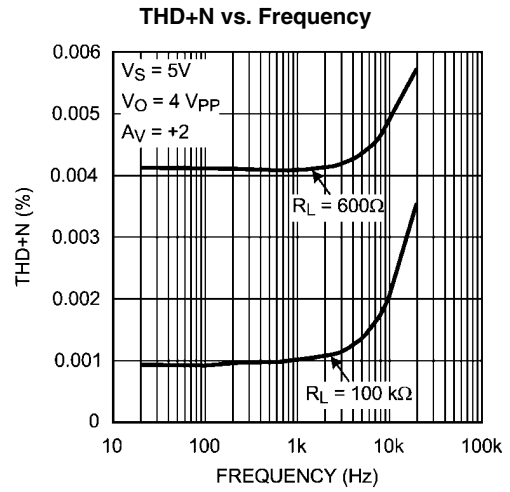

20150355

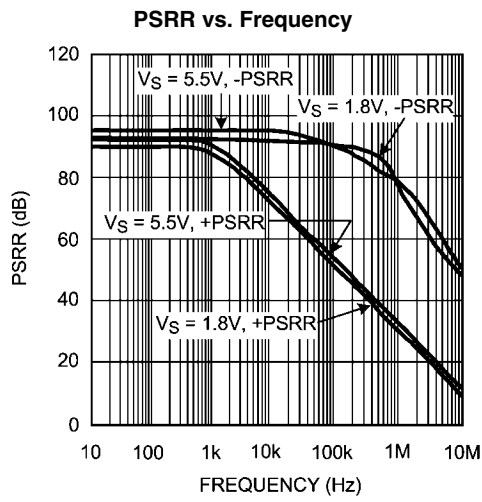

20150328

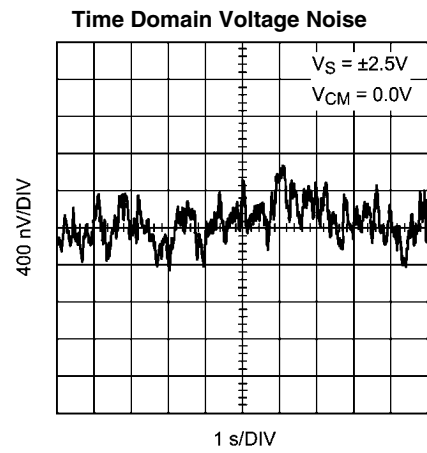

20150382

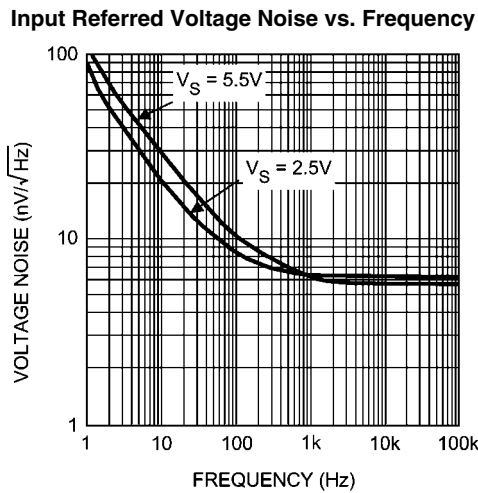

20150339

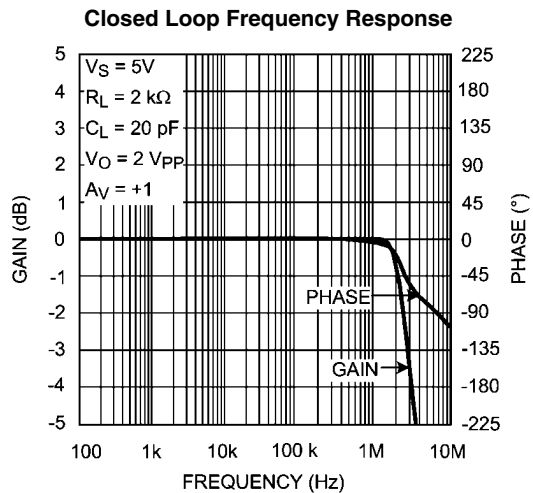

20150336

Closed Loop Output Impedance vs. Frequency

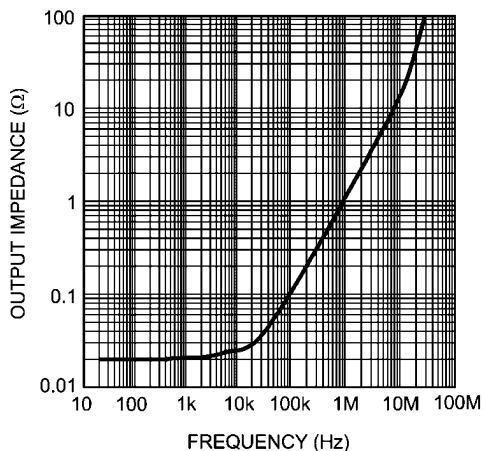

20150332

Application Notes

LMP7711/LMP7712

The LMP7711/LMP7712 are single and dual, low noise, low offset, rail-to-rail output precision amplifiers with a wide gain bandwidth product of 17 MHz and low supply current. The wide bandwidth makes the LMP7711/LMP7712 ideal choices for wide-band amplification in portable applications. The low supply current along with the enable feature that is built-in on the LMP7711/LMP7712 allows for even more power efficient designs by turning the device off when not in use.

The LMP7711/LMP7712 are superior for sensor applications. The very low input referred voltage noise of only 5.8 nV/ $\sqrt{\text{Hz}}$ at 1 kHz and very low input referred current noise of only 10 fA/ $\sqrt{\text{Hz}}$ mean more signal fidelity and higher signal-to-noise ratio.

The LMP7711/LMP7712 have a supply voltage range of 1.8V to 5.5V over a wide temperature range of 0°C to 125°C. This is optimal for low voltage commercial applications. For applications where the ambient temperature might be less than 0°C, the LMP7711/LMP7712 are fully operational at supply voltages of 2.0V to 5.5V over the temperature range of -40°C to 125°C.

The outputs of the LMP7711/LMP7712 swing within 25 mV of either rail providing maximum dynamic range in applications requiring low supply voltage. The input common mode range of the LMP7711/LMP7712 extends to 300 mV below ground. This feature enables users to utilize this device in single supply applications.

The use of a very innovative feedback topology has enhanced the current drive capability of the LMP7711/LMP7712, resulting in sourcing currents as much as 47 mA with a supply voltage of only 1.8V.

The LMP7711 is offered in the space saving TSOT23 package and the LMP7712 is offered in a 10-pin MSOP. These small packages are ideal solutions for applications requiring minimum PC board footprint.

National Semiconductor is heavily committed to precision amplifiers and the market segments they serves. Technical support and extensive characterization data is available for sensitive applications or applications with a constrained error budget.

CAPACITIVE LOAD

The unity gain follower is the most sensitive configuration to capacitive loading. The combination of a capacitive load placed directly on the output of an amplifier along with the output impedance of the amplifier creates a phase lag which in turn reduces the phase margin of the amplifier. If phase margin is significantly reduced, the response will be either underdamped or the amplifier will oscillate.

The LMP7711/LMP7712 can directly drive capacitive loads of up to 120 pF without oscillating. To drive heavier capacitive loads, an isolation resistor, R_{ISO} in *Figure 1*, should be used. This resistor and C_L form a pole and hence delay the phase lag or increase the phase margin of the overall system. The larger the value of R_{ISO} , the more stable the output voltage will be. However, larger values of R_{ISO} result in reduced output swing and reduced output current drive.

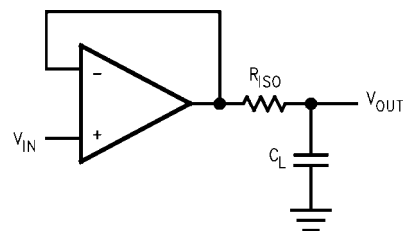

20150361

FIGURE 1. Isolating Capacitive Load

INPUT CAPACITANCE

CMOS input stages inherently have low input bias current and higher input referred voltage noise. The LMP7711/LMP7712 enhance this performance by having the low input bias current of only 50 fA, as well as, a very low input referred voltage noise of 5.8 nV/ $\sqrt{\text{Hz}}$. In order to achieve this a larger input stage has been used. This larger input stage increases the input capacitance of the LMP7711/LMP7712. *Figure 2* shows typical input common mode input capacitance of the LMP7711/LMP7712.

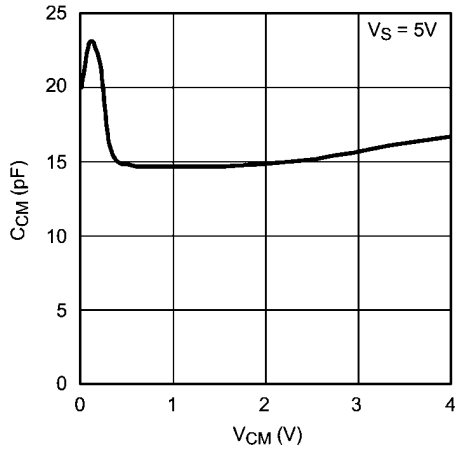

20150375

FIGURE 2. Input Common Mode Capacitance

This input capacitance will interact with other impedances such as gain and feedback resistors, which are seen on the inputs of the amplifier to form a pole. This pole will have little or no effect on the output of the amplifier at low frequencies and under DC conditions, but will play a bigger role as the frequency increases. At higher frequencies, the presence of this pole will decrease phase margin and also causes gain peaking. In order to compensate for the input capacitance, care must be taken in choosing feedback resistors. In addition to being selective in picking values for the feedback resistor, a capacitor can be added to the feedback path to increase stability.

The DC gain of the circuit shown in *Figure 3* is simply $-R_2/R_1$.

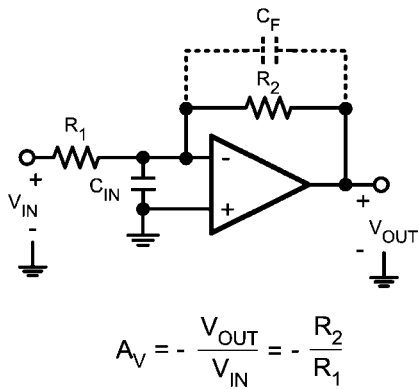

$$A_V = - \frac{V_{OUT}}{V_{IN}} = - \frac{R_2}{R_1}$$

20150364

FIGURE 3. Compensating for Input Capacitance

For the time being, ignore C_F . The AC gain of the circuit in *Figure 3* can be calculated as follows:

$$\frac{V_{OUT}}{V_{IN}}(s) = \frac{-R_2/R_1}{1 + \frac{s}{\left(\frac{A_0 R_1}{R_1 + R_2}\right)} + \frac{s^2}{\left(\frac{A_0}{C_{IN} R_2}\right)}} \quad (1)$$

This equation is rearranged to find the location of the two poles:

$$P_{1,2} = \frac{-1}{2C_{IN}} \left[\frac{1}{R_1} + \frac{1}{R_2} \pm \sqrt{\left(\frac{1}{R_1} + \frac{1}{R_2}\right)^2 - \frac{4 A_0 C_{IN}}{R_2}} \right] \quad (2)$$

As shown in *Equation 2*, as the values of R_1 and R_2 are increased, the magnitude of the poles are reduced, which in turn decreases the bandwidth of the amplifier. *Figure 4* shows the frequency response with different value resistors for R_1 and R_2 . Whenever possible, it is best to choose smaller feedback resistors.

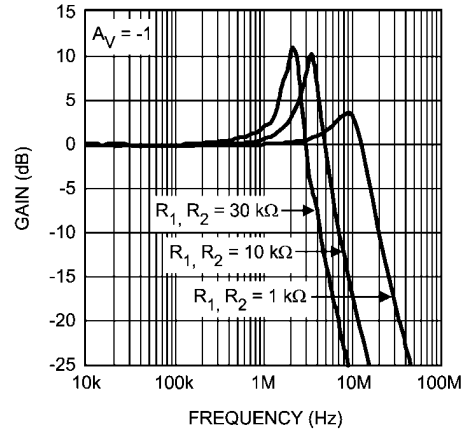

20150359

FIGURE 4. Closed Loop Frequency Response

As mentioned before, adding a capacitor to the feedback path will decrease the peaking. This is because C_F will form yet another pole in the system and will prevent pairs of poles, or complex conjugates from forming. It is the presence of pairs of poles that cause the peaking of gain. *Figure 5* shows the frequency response of the schematic presented in *Figure 3* with different values of C_F . As can be seen, using a small value capacitor significantly reduces or eliminates the peaking.

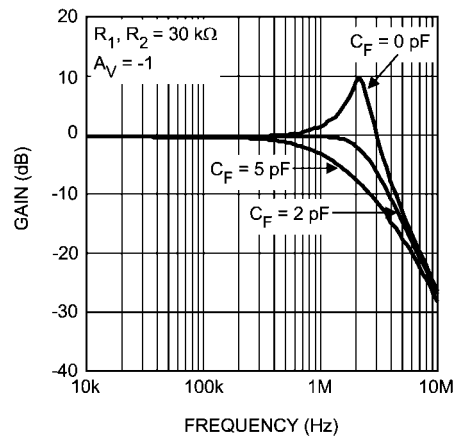

20150360

FIGURE 5. Closed Loop Frequency Response

TRANSIMPEDANCE AMPLIFIER

In many applications, the signal of interest is a very small amount of current that needs to be detected. Current that is transmitted through a photodiode is a good example. Barcode scanners, light meters, fiber optic receivers, and industrial sensors are some typical applications utilizing photodiodes

for current detection. This current needs to be amplified before it can be further processed. This amplification is performed using a current-to-voltage converter configuration or transimpedance amplifier. The signal of interest is fed to the inverting input of an op amp with a feedback resistor in the current path. The voltage at the output of this amplifier will be equal to the negative of the input current times the value of the feedback resistor. *Figure 6* shows a transimpedance amplifier configuration. C_D represents the photodiode parasitic capacitance and C_{CM} denotes the common-mode capacitance of the amplifier. The presence of all of these capacitances at higher frequencies might lead to less stable topologies at higher frequencies. Care must be taken when designing a transimpedance amplifier to prevent the circuit from oscillating.

With a wide gain bandwidth product, low input bias current and low input voltage and current noise, the LMP7711/LMP7712 are ideal for wideband transimpedance applications.

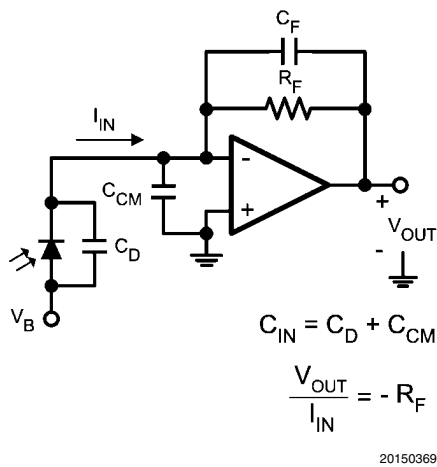

FIGURE 6. Transimpedance Amplifier

A feedback capacitance C_F is usually added in parallel with R_F to maintain circuit stability and to control the frequency response. To achieve a maximally flat, 2nd order response, R_F and C_F should be chosen by using *Equation 3*

$$C_F = \sqrt{\frac{C_{IN}}{GBWP * 2 \pi R_F}} \tag{3}$$

Calculating C_F from *Equation 3* can sometimes result in capacitor values which are less than 2 pF. This is especially the case for high speed applications. In these instances, it's often more practical to use the circuit shown in *Figure 7* in order to allow more sensible choices for C_F . The new feedback capacitor, C'_F , is $(1 + R_B/R_A) C_F$. This relationship holds as long as $R_A \ll R_F$.

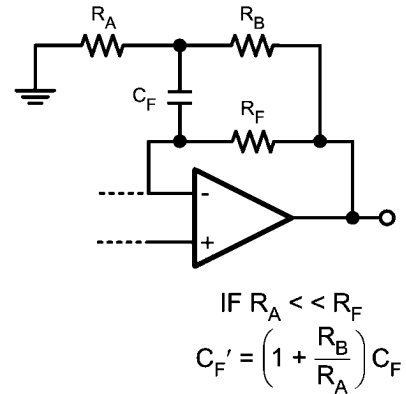

FIGURE 7. Modified Transimpedance Amplifier

SENSOR INTERFACE

The LMP7711/LMP7712 have low input bias current and low input referred noise, which make them ideal choices for sensor interfaces such as thermopiles, Infra Red (IR) thermometry, thermocouple amplifiers, and pH electrode buffers.

Thermopiles generate voltage in response to receiving radiation. These voltages are often only a few microvolts. As a result, the operational amplifier used for this application needs to have low offset voltage, low input voltage noise, and low input bias current. *Figure 8* shows a thermopile application where the sensor detects radiation from a distance and generates a voltage that is proportional to the intensity of the radiation. The two resistors, R_A and R_B , are selected to provide high gain to amplify this signal, while C_F removes the high frequency noise.

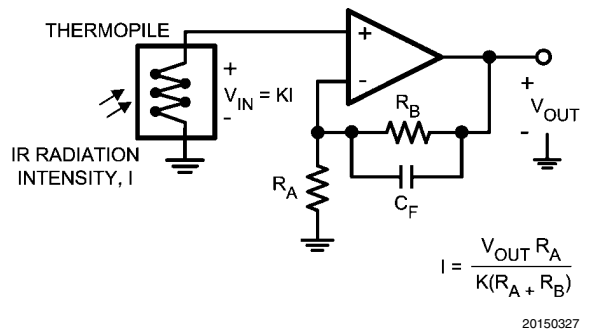

FIGURE 8. Thermopile Sensor Interface

PRECISION RECTIFIER

Rectifiers are electrical circuits used for converting AC signals to DC signals. *Figure 9* shows a full-wave precision rectifier. Each operational amplifier used in this circuit has a diode on its output. This means for the diodes to conduct, the output of the amplifier needs to be positive with respect to ground. If V_{IN} is in its positive half cycle then only the output of the bottom amplifier will be positive. As a result, the diode on the output of the bottom amplifier will conduct and the signal will show at the output of the circuit. If V_{IN} is in its negative half cycle then the output of the top amplifier will be positive, resulting in the diode on the output of the top amplifier conducting and, delivering the signal on the amplifier's output to the circuit's output.

For $R_2/R_1 \geq 2$, the resistor values can be found by using the equation shown in *Figure 9*. If $R_2/R_1 = 1$, then R_3 should be

left open, no resistor needed, and R_4 should simply be shorted.

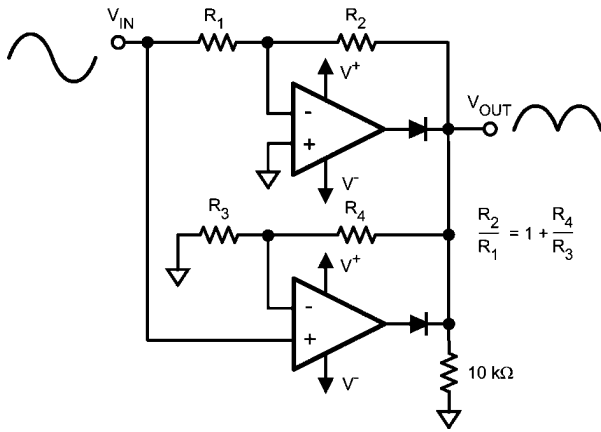

20150374

FIGURE 9. Precision Rectifier

Physical Dimensions inches (millimeters) unless otherwise noted

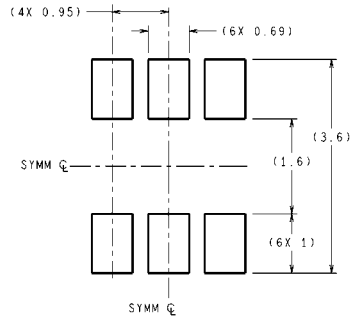
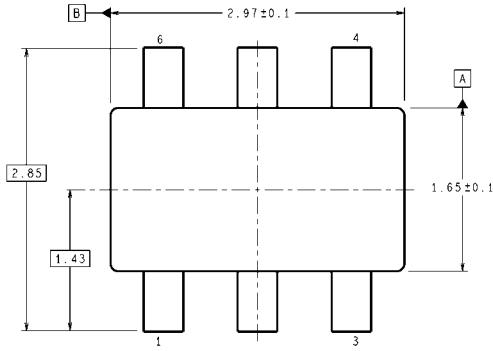

RECOMMENDED LAND PATTERN

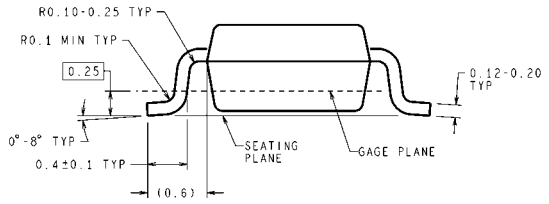
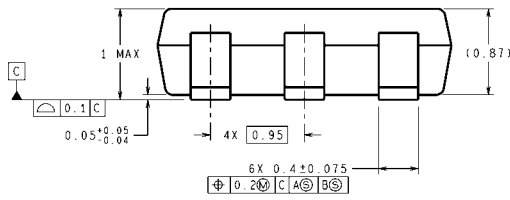

DIMENSIONS ARE IN MILLIMETERS

MK06A (Rev D)

**6-Pin TSOT23
NS Package Number MK06A**

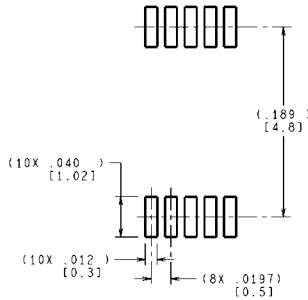
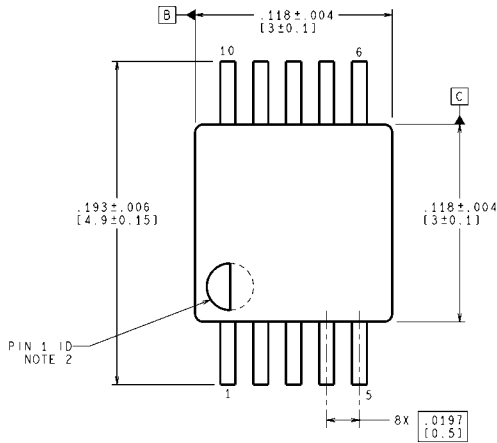

LAND PATTERN RECOMMENDATION

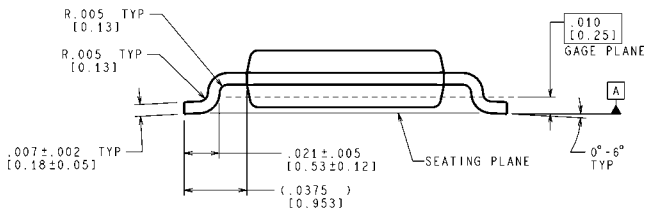
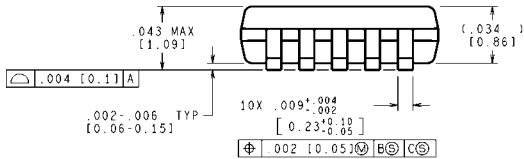

CONTROLLING DIMENSION IS INCH
VALUES IN [] ARE MILLIMETERS
DIMENSIONS IN () FOR REFERENCE ONLY

MUB10A (Rev B)

**10-Pin MSOP
NS Package Number MUB10A**

Notes

Notes

For more National Semiconductor product information and proven design tools, visit the following Web sites at:

Products		Design Support	
Amplifiers	www.national.com/amplifiers	WEBENCH	www.national.com/webench
Audio	www.national.com/audio	Analog University	www.national.com/AU
Clock Conditioners	www.national.com/timing	App Notes	www.national.com/appnotes
Data Converters	www.national.com/adc	Distributors	www.national.com/contacts
Displays	www.national.com/displays	Green Compliance	www.national.com/quality/green
Ethernet	www.national.com/ethernet	Packaging	www.national.com/packaging
Interface	www.national.com/interface	Quality and Reliability	www.national.com/quality
LVDS	www.national.com/lvds	Reference Designs	www.national.com/refdesigns
Power Management	www.national.com/power	Feedback	www.national.com/feedback
Switching Regulators	www.national.com/switchers		
LDOs	www.national.com/lido		
LED Lighting	www.national.com/led		
PowerWise	www.national.com/powerwise		
Serial Digital Interface (SDI)	www.national.com/sdi		
Temperature Sensors	www.national.com/tempsensors		
Wireless (PLL/VCO)	www.national.com/wireless		

THE CONTENTS OF THIS DOCUMENT ARE PROVIDED IN CONNECTION WITH NATIONAL SEMICONDUCTOR CORPORATION ("NATIONAL") PRODUCTS. NATIONAL MAKES NO REPRESENTATIONS OR WARRANTIES WITH RESPECT TO THE ACCURACY OR COMPLETENESS OF THE CONTENTS OF THIS PUBLICATION AND RESERVES THE RIGHT TO MAKE CHANGES TO SPECIFICATIONS AND PRODUCT DESCRIPTIONS AT ANY TIME WITHOUT NOTICE. NO LICENSE, WHETHER EXPRESS, IMPLIED, ARISING BY ESTOPPEL OR OTHERWISE, TO ANY INTELLECTUAL PROPERTY RIGHTS IS GRANTED BY THIS DOCUMENT.

TESTING AND OTHER QUALITY CONTROLS ARE USED TO THE EXTENT NATIONAL DEEMS NECESSARY TO SUPPORT NATIONAL'S PRODUCT WARRANTY. EXCEPT WHERE MANDATED BY GOVERNMENT REQUIREMENTS, TESTING OF ALL PARAMETERS OF EACH PRODUCT IS NOT NECESSARILY PERFORMED. NATIONAL ASSUMES NO LIABILITY FOR APPLICATIONS ASSISTANCE OR BUYER PRODUCT DESIGN. BUYERS ARE RESPONSIBLE FOR THEIR PRODUCTS AND APPLICATIONS USING NATIONAL COMPONENTS. PRIOR TO USING OR DISTRIBUTING ANY PRODUCTS THAT INCLUDE NATIONAL COMPONENTS, BUYERS SHOULD PROVIDE ADEQUATE DESIGN, TESTING AND OPERATING SAFEGUARDS.

EXCEPT AS PROVIDED IN NATIONAL'S TERMS AND CONDITIONS OF SALE FOR SUCH PRODUCTS, NATIONAL ASSUMES NO LIABILITY WHATSOEVER, AND NATIONAL DISCLAIMS ANY EXPRESS OR IMPLIED WARRANTY RELATING TO THE SALE AND/OR USE OF NATIONAL PRODUCTS INCLUDING LIABILITY OR WARRANTIES RELATING TO FITNESS FOR A PARTICULAR PURPOSE, MERCHANTABILITY, OR INFRINGEMENT OF ANY PATENT, COPYRIGHT OR OTHER INTELLECTUAL PROPERTY RIGHT.

LIFE SUPPORT POLICY

NATIONAL'S PRODUCTS ARE NOT AUTHORIZED FOR USE AS CRITICAL COMPONENTS IN LIFE SUPPORT DEVICES OR SYSTEMS WITHOUT THE EXPRESS PRIOR WRITTEN APPROVAL OF THE CHIEF EXECUTIVE OFFICER AND GENERAL COUNSEL OF NATIONAL SEMICONDUCTOR CORPORATION. As used herein:

Life support devices or systems are devices which (a) are intended for surgical implant into the body, or (b) support or sustain life and whose failure to perform when properly used in accordance with instructions for use provided in the labeling can be reasonably expected to result in a significant injury to the user. A critical component is any component in a life support device or system whose failure to perform can be reasonably expected to cause the failure of the life support device or system or to affect its safety or effectiveness.

National Semiconductor and the National Semiconductor logo are registered trademarks of National Semiconductor Corporation. All other brand or product names may be trademarks or registered trademarks of their respective holders.

Copyright© 2008 National Semiconductor Corporation

For the most current product information visit us at www.national.com



National Semiconductor Americas Technical Support Center
Email: support@nsc.com
Tel: 1-800-272-9959

National Semiconductor Europe Technical Support Center
Email: europe.support@nsc.com
German Tel: +49 (0) 180 5010 771
English Tel: +44 (0) 870 850 4288

National Semiconductor Asia Pacific Technical Support Center
Email: ap.support@nsc.com

National Semiconductor Japan Technical Support Center
Email: jpn.feedback@nsc.com