

51863-4 ✓ ACTIVE



PIDG

TE Internal #: 51863-4

Closed Ring Tongue Terminal, 18 AWG, M3.5 Stud Size, 3.68 mm [.145 in] Stud Diameter, Closed Barrel, Straight, Tin, Partially Insulated, PIDG

[View on TE.com >](#)

Terminals & Splices > Ring Terminals > PIDG Ring Tongue Terminals

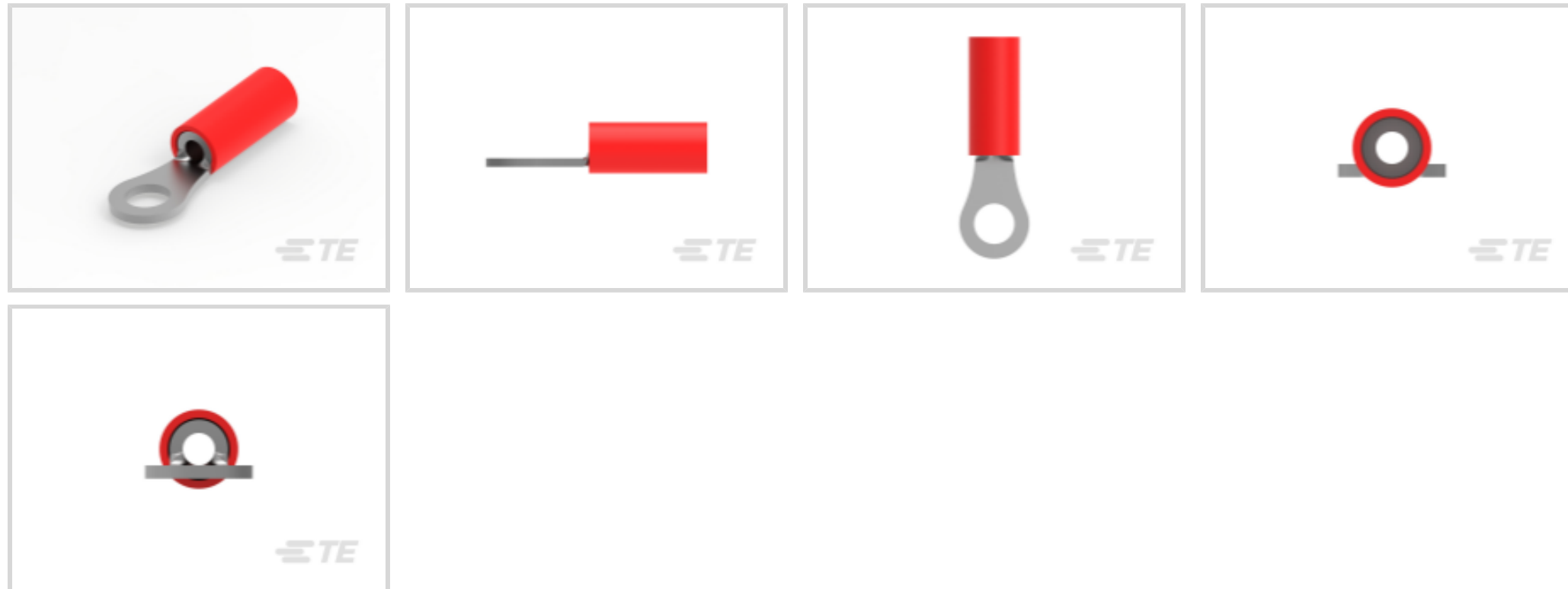

Ring Terminal Product Type: Closed Ring Tongue Terminal

Wire Size: 1900 CMA

Stud Size: M3.5

Stud Diameter: 3.68 mm [.145 in]

[All PIDG Ring Tongue Terminals \(411\)](#)

Features

Product Type Features

Ring Terminal Product Type	Closed Ring Tongue Terminal
Stud Size	M3.5
Sealable	No
Wire Insulation Support Retention Type	Insulation Restriction

Configuration Features

Number of Holes	1
-----------------	---

Electrical Characteristics

Voltage Rating	300 V
----------------	-------

Body Features

Insulation Sleeve Color	Red
Stripe Color	White
Product Weight	.767 g

Contact Features



Military Part Class	Class I
Barrel Type	Closed
Terminal Orientation	Straight
Terminal Plating Material	Tin

### Mechanical Attachment

Wire Insulation Support	With
-------------------------	------

### Dimensions

Wire Size	1900 CMA
Stud Diameter	3.68 mm [.145 in]
Tongue Thickness	.79 mm [.031 in]
Product Length	19.86 mm [.782 in]
Compatible Insulation Diameter (Max)	2.79 mm [.11 in]
Compatible Insulation Diameter Range	1.42 – 2.79 mm [.056 – .11 in]

### Usage Conditions

Insulation Option	Partially Insulated
Operating Temperature Range	105 °C [221 °F]

### Operation/Application

Compatible With Wire Base Material	Copper
Compatible With Wire Plating Material	Tin

### Industry Standards

Government Qualified Terminal	Yes
-------------------------------	-----

### Packaging Features

Packaging Quantity	1000
Packaging Method	Loose Piece

### Product Compliance

[For compliance documentation, visit the product page on TE.com>](#)

EU RoHS Directive 2011/65/EU	Compliant
EU ELV Directive 2000/53/EC	Compliant
China RoHS 2 Directive MIIT Order No 32, 2016	No Restricted Materials Above Threshold
EU REACH Regulation (EC) No. 1907/2006	Current ECHA Candidate List: JUNE 2024 (241)









Candidate List Declared Against: JUNE 2024 (241)  
Does not contain REACH SVHC

Halogen Content	Low Halogen - Br, Cl, F, I < 900 ppm per homogenous material. Also BFR/CFR/PVC Free
Solder Process Capability	Not applicable for solder process capability

Product Compliance Disclaimer

This information is provided based on reasonable inquiry of our suppliers and represents our current actual knowledge based on the information they provided. This information is subject to change. The part numbers that TE has identified as EU RoHS compliant have a maximum concentration of 0.1% by weight in homogenous materials for lead, hexavalent chromium, mercury, PBB, PBDE, DBP, BBP, DEHP, DIBP, and 0.01% for cadmium, or qualify for an exemption to these limits as defined in the Annexes of Directive 2011/65/EU (RoHS2). Finished electrical and electronic equipment products will be CE marked as required by Directive 2011/65/EU. Components may not be CE marked. Additionally, the part numbers that TE has identified as EU ELV compliant have a maximum concentration of 0.1% by weight in homogenous materials for lead, hexavalent chromium, and mercury, and 0.01% for cadmium, or qualify for an exemption to these limits as defined in the Annexes of Directive 2000/53/EC (ELV). Regarding the REACH Regulation, the information TE provides on SVHC in articles for this part number is based on the latest European Chemicals Agency (ECHA) 'Guidance on requirements for substances in articles' posted at this URL: <https://echa.europa.eu/guidance-documents/guidance-on-reach>

## Compatible Parts

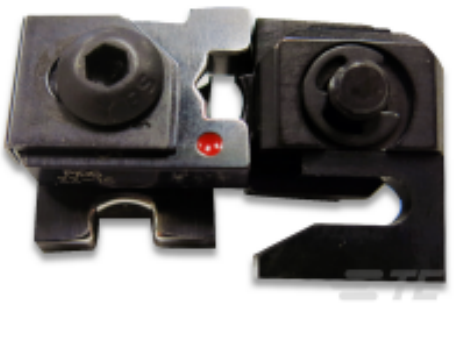
 <p>REPRESENTATION ONLY</p> <p>TE Part # 47386-4 DAHT PG PIDG 26-16 ASSY</p>	 <p>TE Part # 58423-1 DIE, RBY IS9252</p>	 <p>TE Part # 59170 T-HEAD PIDG SH 26-14 ASSY</p>	 <p>REPRESENTATION ONLY</p> <p>TE Part # 47386 DAHT PG PIDG 26-16 ASSY</p>
 <p>TE Part # 58433-3 PRO CR ASSY, RBY IS9252</p>	 <p>REPRESENTATION ONLY</p> <p>TE Part # 525690 DAHT PG PIDG 20-18 ASSY</p>	 <p>TE Part # 2063030-1 SDE DIESET, RBY, UL</p>	 <p>TE Part # 47806-2 DIES PIDG 22-16 DIE SET</p>

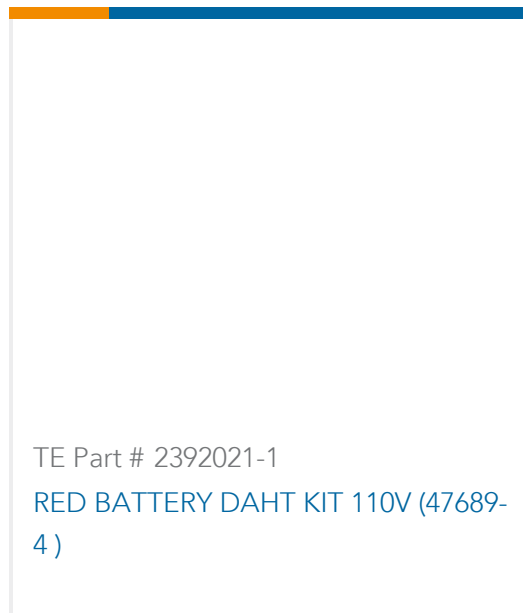
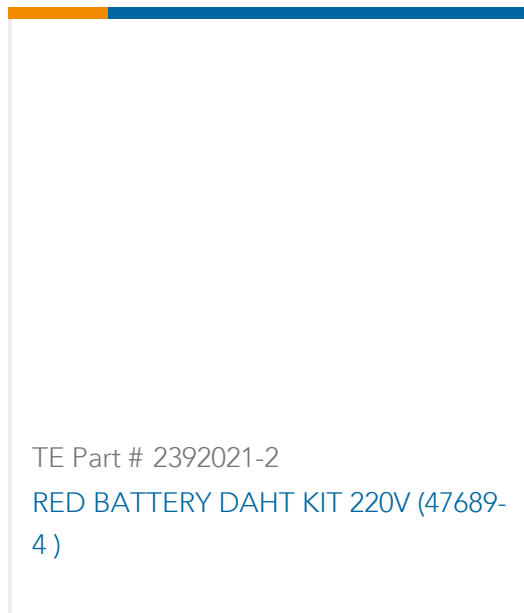

Also in the Series | PIDG

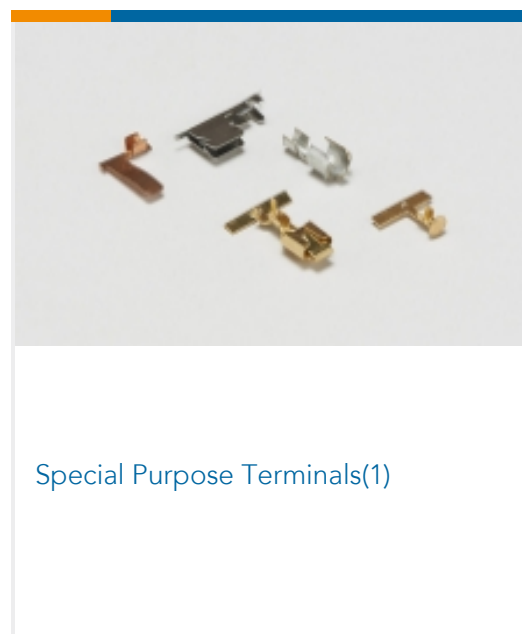
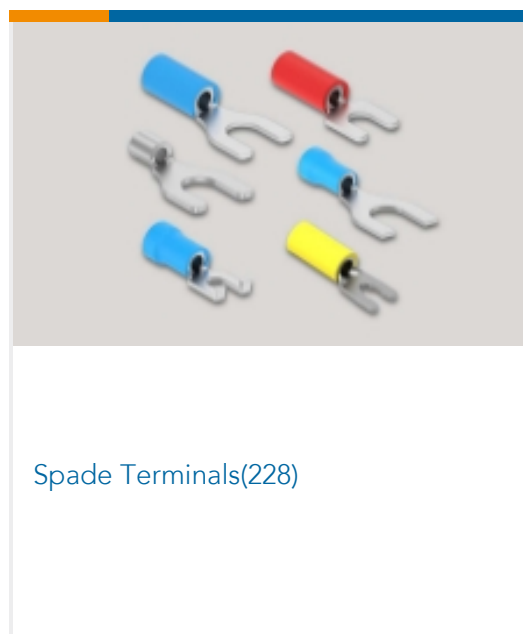
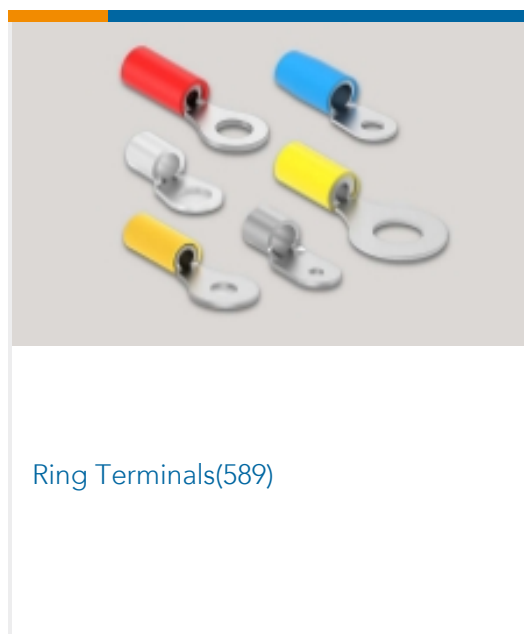
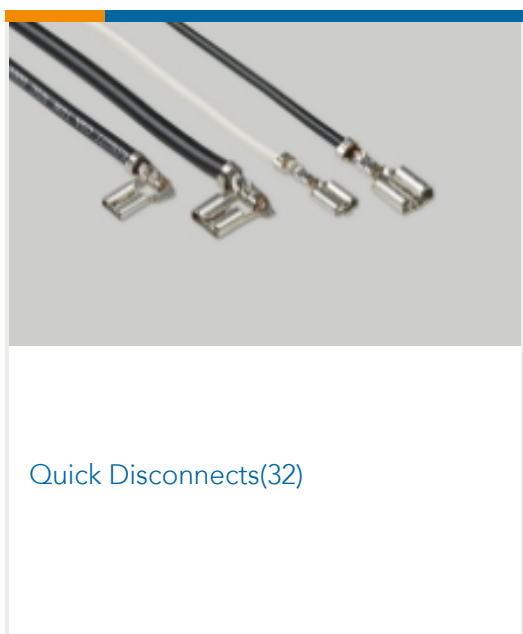
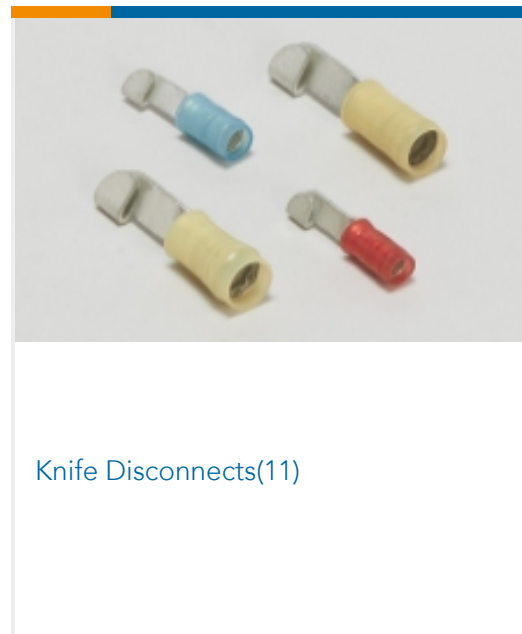
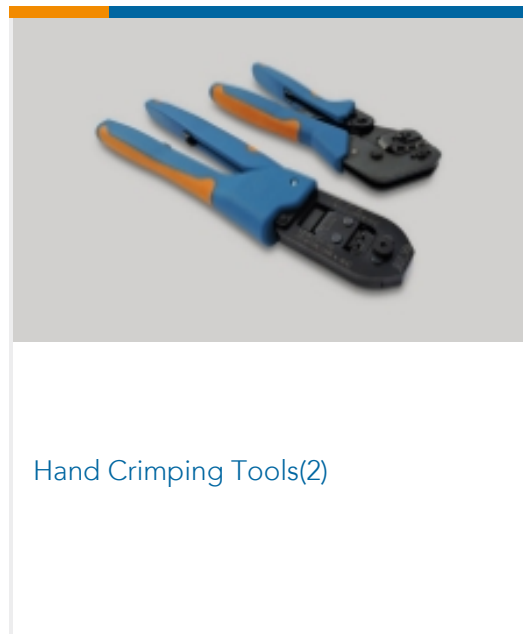
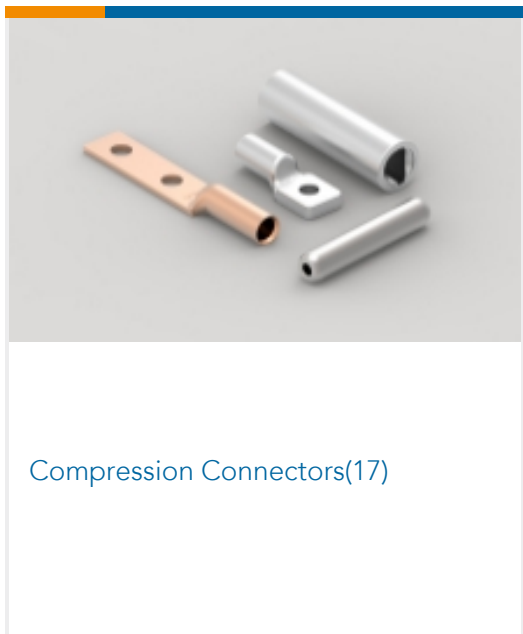

Customers Also Bought

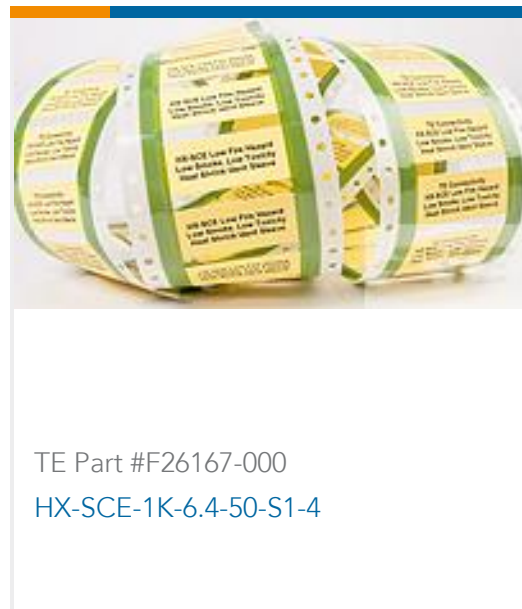
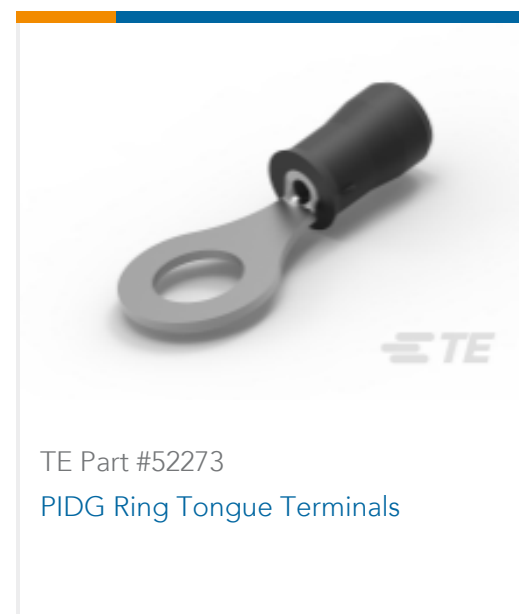
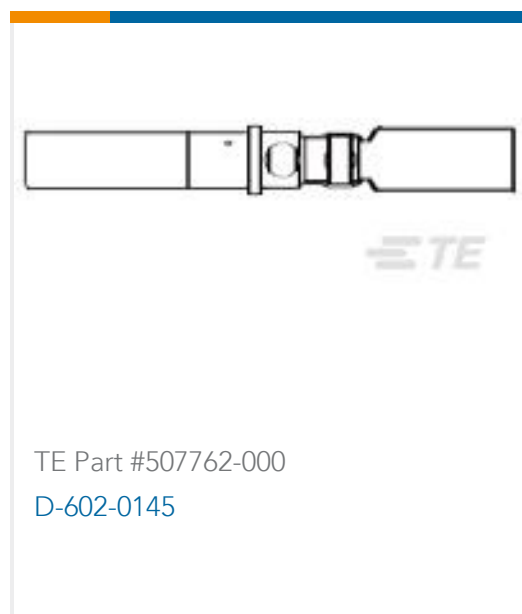

## Documents

### Product Drawings

[TERMINAL,PIDG R IR 18 6](#)

English

### CAD Files

[3D PDF](#)

3D

Customer View Model

[ENG\\_CVM\\_CVM\\_51863-4\\_AC.2d\\_dxf.zip](#)

English

Customer View Model

[ENG\\_CVM\\_CVM\\_51863-4\\_AC.3d\\_igs.zip](#)

English

Customer View Model

[ENG\\_CVM\\_CVM\\_51863-4\\_AC.3d\\_stp.zip](#)

English

By downloading the CAD file I accept and agree to the [Terms and Conditions](#) of use.

### Agency Approvals

[CSA Certificate](#)

English

[CSA Certificate](#)

English