

# ASMY-CWG0-Nxxx2

## Low Power 2216 DFN2 Surface Mount LED

### Overview

The Broadcom<sup>®</sup> ASMY-CWG0 surface mount LEDs use InGaN chip technology with superior package design to enable them to produce higher light output with better intensity performance. They are able to dissipate the heat more efficiently resulting in better performance with higher reliability.

To facilitate easy pick and place assembly, the LEDs are packed in tape and reel. Every reel is shipped in single intensity and color bin, to provide close uniformity.

### Features

- High reliability package with enhanced silicone resin encapsulation
- Available in 2700K, 3000K, 3500K, 4000K, 4500K, 5000K, 5700K 6200K, 6500K, and 8000K CCT only
- Wide viewing angle at 120°
- Low package profile and large emitting area for better uniformity in linear lighting

### Applications

- Indicators
- Electronic signs and displays
  - Channel lettering
  - Contour lighting
  - Indoor variable message sign
- Office automations, home appliances, industrial equipment
  - Front panel backlighting
  - Push button backlighting
  - Display backlighting
  - Keypad backlighting
  - Symbol backlighting
  - Scanner lighting

#### CAUTION!

This LED is ESD sensitive. Please observe appropriate precautions during handling and processing. Refer to application note AN-1142 for additional detail.

Figure 1: Package Drawing

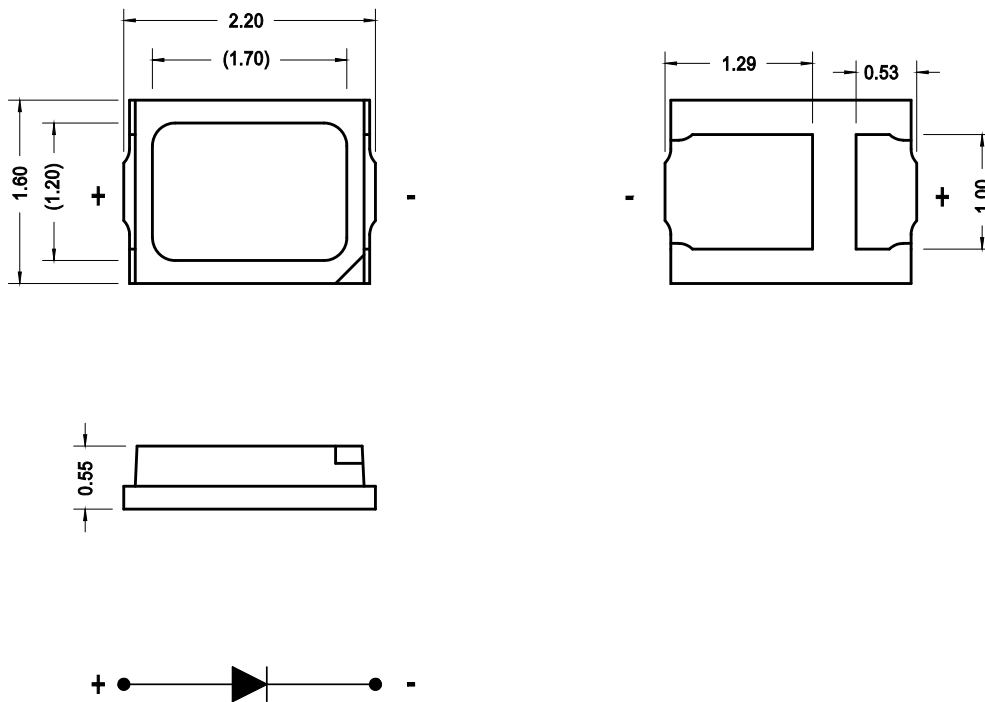

**NOTE:**

1. All dimensions in millimeters (mm).
2. Tolerance is  $\pm 0.20\text{mm}$  unless otherwise specified.
3. Encapsulation = silicone.
4. Terminal finish = silver plating.
5. Dimensions in brackets are for reference only.

**Device Selection Guide ( $T_J = 25^\circ\text{C}$ ,  $I_F = 20\text{mA}$ )**

Part Number	Correlated Color Temperature, CCT (Kelvin)	Luminous Intensity, $I_v$ (mcd) <sup>a, b</sup>			Luminous Flux, $\Phi_v$ (lm) <sup>c</sup>
	Typ.	Min.	Typ.	Max.	Typ.
ASMY-CWG0-NX7A2	8000	2240	2500	4500	7.8
ASMY-CWG0-NX7B2	6500	2240	2500	4500	7.8
ASMY-CWG0-NX7C2	5700	2240	2500	4500	7.8
ASMY-CWG0-NX7D2	5000	2240	2600	4500	8.1
ASMY-CWG0-NX7E2	4500	2240	2600	4500	8.1
ASMY-CWG0-NX7F2	4000	2240	2600	4500	8.1
ASMY-CWG0-NX7G2	3500	2240	2600	4500	8.1
ASMY-CWG0-NX7H2	3000	2240	2600	4500	8.1
ASMY-CWG0-NX7J2	2700	2240	2500	4500	7.8

- a. The luminous intensity,  $I_v$  is measured at the mechanical axis of the package and it is tested with a single current pulse condition. The actual peak of the spatial radiation pattern may not be aligned with the axis.
- b. Tolerance is  $\pm 12\%$
- c. For reference only.

## Absolute Maximum Ratings

Parameters	ASMY-CWG0-Nxxx2	Unit
DC Forward Current <sup>a</sup>	25	mA
Peak Forward Current <sup>b</sup>	100	mA
Power Dissipation	90	mW
Reverse Voltage	Not designed for reverse bias operation	
LED Junction Temperature	110	°C
Operating Temperature Range	-40 to +100	°C
Storage Temperature Range	-40 to +100	°C

a. Derate linearly as shown in Figure 16 and Figure 17.

b. Duty factor = 10%, frequency = 1kHz.

## Optical and Electrical Characteristics (T<sub>J</sub> = 25°C, I<sub>F</sub> = 20mA)

Parameters	Min.	Typ.	Max.	Unit
Viewing Angle, 2θ <sub>½</sub> <sup>a</sup>	–	120	–	°
Forward Voltage, V <sub>F</sub> <sup>b</sup>	2.60	2.83	3.60	V
Reverse Current, I <sub>R</sub> at V <sub>R</sub> = 5V <sup>c</sup>	–	–	10	μA
Color Rendering Index, CRI	80	–	–	–
Thermal Resistance, R <sub>θJ-S</sub> <sup>d</sup>	–	80	–	°C/W

a. θ<sub>½</sub> is the off-axis angle where the luminous intensity is half of the peak intensity.

b. Forward voltage tolerance is ±0.1V.

c. Indicates product final test condition. Long term reverse bias is not recommended.

d. Thermal resistance from LED junction to solder point.

# Part Numbering System

A S M Y - C W G 0 - N 

x <sub>2</sub>	x <sub>3</sub>	x <sub>4</sub>
----------------	----------------	----------------

 2

Code	Description	Option	
x <sub>1</sub>	Minimum Intensity Bin	X	
x <sub>2</sub>	Number of sub-bins	7	3 sub-bins, starting from bin X2
x <sub>3</sub>	Color Correlated Temperature	A	8000K
		B	6500K
		C	5700K
		D	5000K
		E	4500K
		F	4000K
		G	3500K
		H	3000K
		J	2700K

## Part Number Example

ASMY-CWG0-NX7D2

- x<sub>1</sub> : X            – Minimum Intensity bin X
- x<sub>2</sub> : 7            – Three intensity sub-bins, starting from sub-bin X2
- x<sub>3</sub> : D            – CCT 5000K with bin ID 4A1, 4A2, 4B1, 4B2, 4C1, 4C2, 4D1, 4D2

## Bin Information

### Flux Bin Limits (CAT)

Bin ID	Luminous Intensity, I <sub>v</sub> (mcd)	
	Min.	Max.
X2	2240	2850
Y1	2850	3550
Y2	3550	4500

Tolerance = ±12%

### Forward Voltage Bin Limits (VF)

Bin ID	Forward Voltage, V <sub>F</sub> (V)	
	Min.	Max.
F04	2.6	2.8
F05	2.8	3.0
F06	3.0	3.2
F07	3.2	3.4
F08	3.4	3.6

Tolerance = ±0.1V

Example of bin information on reel and packaging label:

- CAT : X2 – Intensity bin X2
- BIN : 4B1 – Color bin 4B1
- VF : F06 – VF bin F06

### Color Bin Limits (BIN)

CCT	Bin ID	Chromaticity Coordinates		CCT	Bin ID	Chromaticity Coordinates		CCT	Bin ID	Chromaticity Coordinates	
		x	y			x	y			x	y
8000K	1A1	0.2935	0.3015	6500K	2A1	0.3058	0.3161	5700K	3A1	0.3218	0.3298
		0.2997	0.3088			0.3137	0.3238			0.3293	0.3364
		0.3009	0.3042			0.3145	0.3187			0.3294	0.3306
		0.2950	0.2970			0.3068	0.3113			0.3222	0.3243
	1A2	0.2935	0.3015		2A2	0.3048	0.3209		3A2	0.3214	0.3352
		0.2920	0.3060			0.3131	0.3290			0.3293	0.3423
		0.2984	0.3133			0.3137	0.3238			0.3293	0.3364
		0.2997	0.3088			0.3058	0.3161			0.3218	0.3298
	1B1	0.2920	0.3060		2B1	0.3038	0.3256		3B1	0.3210	0.3407
		0.2908	0.3098			0.3123	0.3341			0.3292	0.3481
		0.2973	0.3177			0.3131	0.3290			0.3293	0.3423
		0.2984	0.3133			0.3048	0.3209			0.3214	0.3352
	1B2	0.2908	0.3098		2B2	0.3028	0.3304		3B2	0.3206	0.3461
		0.2973	0.3177			0.3117	0.3393			0.3292	0.3539
		0.2962	0.3220			0.3123	0.3341			0.3292	0.3481
		0.2895	0.3135			0.3038	0.3256			0.3210	0.3407
	1C1	0.2984	0.3133		2C1	0.3123	0.3341		3C1	0.3292	0.3481
		0.2973	0.3177			0.3209	0.3426			0.3374	0.3554
		0.3038	0.3256			0.3213	0.3371			0.3371	0.3493
		0.3048	0.3207			0.3131	0.3290			0.3293	0.3423
	1C2	0.2973	0.3177		2C2	0.3117	0.3393		3C2	0.3292	0.3481
		0.2962	0.3220			0.3205	0.3481			0.3374	0.3554
		0.3028	0.3304			0.3209	0.3426			0.3376	0.3616
		0.3038	0.3256			0.3123	0.3341			0.3292	0.3539
	1D1	0.3009	0.3042		2D1	0.3137	0.3238		3D1	0.3293	0.3364
		0.2997	0.3088			0.3217	0.3316			0.3369	0.3431
		0.3058	0.3160			0.3221	0.3261			0.3366	0.3369
		0.3068	0.3113			0.3145	0.3187			0.3294	0.3306
1D2	0.2997	0.3088	2D2	0.3131	0.3290	3D2	0.3293	0.3423			
	0.2984	0.3133		0.3213	0.3371		0.3371	0.3493			
	0.3048	0.3207		0.3217	0.3316		0.3369	0.3431			
	0.3058	0.3160		0.3137	0.3238		0.3293	0.3364			

CCT	Bin ID	Chromaticity Coordinates		CCT	Bin ID	Chromaticity Coordinates		CCT	Bin ID	Chromaticity Coordinates	
		x	y			x	y			x	y
5000K	4A1	0.3369	0.3431	4500K	5A1	0.3521	0.3533	4000K	6A1	0.3670	0.3578
		0.3446	0.3493			0.3604	0.3592			0.3686	0.3649
		0.3441	0.3428			0.3591	0.3522			0.3744	0.3685
		0.3366	0.3369			0.3512	0.3465			0.3726	0.3612
	4A2	0.3371	0.3493		5A2	0.3530	0.3601		6A2	0.3686	0.3649
		0.3452	0.3558			0.3617	0.3663			0.3702	0.3722
		0.3446	0.3493			0.3604	0.3592			0.3763	0.3760
		0.3369	0.3431			0.3521	0.3533			0.3744	0.3685
	4B1	0.3374	0.3554		5B1	0.3539	0.3668		6A3	0.3744	0.3685
		0.3458	0.3623			0.3629	0.3734			0.3763	0.3760
		0.3452	0.3558			0.3617	0.3663			0.3825	0.3798
		0.3371	0.3493			0.3530	0.3601			0.3804	0.3721
	4B2	0.3374	0.3554		5B2	0.3548	0.3736		6A4	0.3726	0.3612
		0.3458	0.3623			0.3642	0.3805			0.3744	0.3685
		0.3464	0.3688			0.3629	0.3734			0.3804	0.3721
		0.3376	0.3616			0.3539	0.3668			0.3783	0.3646
	4C1	0.3542	0.3692		5C1	0.3629	0.3734		6B1	0.3702	0.3722
		0.3533	0.3623			0.3720	0.3800			0.3719	0.3797
		0.3452	0.3558			0.3703	0.3726			0.3782	0.3837
		0.3458	0.3623			0.3617	0.3663			0.3763	0.3760
	4C2	0.3458	0.3623		5C2	0.3642	0.3805		6B2	0.3719	0.3797
		0.3542	0.3692			0.3736	0.3874			0.3736	0.3874
		0.3551	0.3760			0.3720	0.3800			0.3802	0.3916
		0.3464	0.3688			0.3629	0.3734			0.3782	0.3837
	4D1	0.3446	0.3493		5D1	0.3604	0.3592		6B3	0.3782	0.3837
		0.3524	0.3555			0.3687	0.3652			0.3802	0.3916
		0.3515	0.3487			0.3670	0.3578			0.3869	0.3958
		0.3441	0.3428			0.3591	0.3522			0.3847	0.3877
4D2	0.3452	0.3558	5D2	0.3617	0.3663	6B4	0.3763	0.3760			
	0.3533	0.3623		0.3703	0.3726		0.3782	0.3837			
	0.3524	0.3555		0.3687	0.3652		0.3847	0.3877			
	0.3446	0.3493		0.3604	0.3592		0.3825	0.3798			

CCT	Bin ID	Chromaticity Coordinates		CCT	Bin ID	Chromaticity Coordinates		CCT	Bin ID	Chromaticity Coordinates	
		x	y			x	y			x	y
4000K	6C1	0.3825	0.3798	3500K	7A1	0.3889	0.3690	3500K	7C1	0.4080	0.3916
		0.3847	0.3877			0.3915	0.3768			0.4113	0.4001
		0.3912	0.3917			0.3981	0.3800			0.4186	0.4037
		0.3887	0.3836			0.3953	0.3720			0.4150	0.3950
	6C2	0.3847	0.3877		7A2	0.3915	0.3768		7C2	0.4113	0.4001
		0.3869	0.3958			0.3941	0.3848			0.4146	0.4089
		0.3937	0.4001			0.4010	0.3882			0.4222	0.4127
		0.3912	0.3917			0.3981	0.3800			0.4186	0.4037
	6C3	0.3912	0.3917		7A3	0.3981	0.3800		7C3	0.4186	0.4037
		0.3937	0.4001			0.4010	0.3882			0.4222	0.4127
		0.4006	0.4044			0.4080	0.3916			0.4299	0.4165
		0.3978	0.3958			0.4048	0.3832			0.4259	0.4073
	6C4	0.3887	0.3836		7A4	0.3953	0.3720		7C4	0.4150	0.3950
		0.3912	0.3917			0.3981	0.3800			0.4186	0.4037
		0.3978	0.3958			0.4048	0.3832			0.4259	0.4073
		0.3950	0.3875			0.4017	0.3751			0.4221	0.3984
	6D1	0.3783	0.3646		7B1	0.3941	0.3848		7D1	0.4017	0.3751
		0.3804	0.3721			0.3968	0.3930			0.4048	0.3832
		0.3863	0.3758			0.4040	0.3966			0.4116	0.3865
		0.3840	0.3681			0.4010	0.3882			0.4082	0.3782
	6D2	0.3804	0.3721		7B2	0.3968	0.3930		7D2	0.4048	0.3832
		0.3825	0.3798			0.3996	0.4015			0.4080	0.3916
		0.3887	0.3836			0.4071	0.4052			0.4150	0.3950
		0.3863	0.3758			0.4040	0.3966			0.4116	0.3865
	6D3	0.3863	0.3758		7B3	0.4040	0.3966		7D3	0.4116	0.3865
		0.3887	0.3836			0.4071	0.4052			0.4150	0.3950
		0.3950	0.3875			0.4146	0.4089			0.4221	0.3984
		0.3924	0.3794			0.4113	0.4001			0.4183	0.3898
	6D4	0.3840	0.3681		7B4	0.4010	0.3882		7D4	0.4082	0.3782
		0.3863	0.3758			0.4040	0.3966			0.4116	0.3865
		0.3924	0.3794			0.4113	0.4001			0.4183	0.3898
		0.3898	0.3716			0.4080	0.3916			0.4147	0.3814

CCT	Bin ID	Chromaticity Coordinates		CCT	Bin ID	Chromaticity Coordinates		CCT	Bin ID	Chromaticity Coordinates	
		x	y			x	y			x	y
3000K	8A1	0.4147	0.3814	3000K	8C1	0.4342	0.4028	2700K	9A1	0.4373	0.3893
		0.4183	0.3898			0.4385	0.4119			0.4418	0.3981
		0.4242	0.3919			0.4449	0.4141			0.4475	0.3994
		0.4203	0.3833			0.4403	0.4049			0.4428	0.3906
	8A2	0.4183	0.3898		8C2	0.4385	0.4119		9A2	0.4418	0.3981
		0.4221	0.3984			0.4430	0.4212			0.4465	0.4071
		0.4281	0.4006			0.4496	0.4236			0.4523	0.4085
		0.4242	0.3919			0.4449	0.4141			0.4475	0.3994
	8A3	0.4242	0.3919		8C3	0.4449	0.4141		9A3	0.4475	0.3994
		0.4281	0.4006			0.4496	0.4236			0.4523	0.4085
		0.4342	0.4028			0.4562	0.4260			0.4582	0.4099
		0.4300	0.3939			0.4513	0.4164			0.4532	0.4008
	8A4	0.4203	0.3833		8C4	0.4403	0.4049		9A4	0.4428	0.3906
		0.4242	0.3919			0.4449	0.4141			0.4475	0.3994
		0.4300	0.3939			0.4513	0.4164			0.4532	0.4008
		0.4259	0.3853			0.4465	0.4071			0.4483	0.3919
	8B1	0.4221	0.3984		8D1	0.4259	0.3853		9B1	0.4465	0.4071
		0.4259	0.4073			0.4300	0.3939			0.4513	0.4164
		0.4322	0.4096			0.4359	0.3960			0.4573	0.4178
		0.4281	0.4006			0.4316	0.3873			0.4523	0.4085
	8B2	0.4259	0.4073		8D2	0.4300	0.3939		9B2	0.4513	0.4164
		0.4299	0.4165			0.4342	0.4028			0.4562	0.4260
		0.4364	0.4188			0.4403	0.4049			0.4624	0.4274
		0.4322	0.4096			0.4359	0.3960			0.4573	0.4178
	8B3	0.4322	0.4096		8D3	0.4359	0.3960		9B3	0.4573	0.4178
		0.4364	0.4188			0.4403	0.4049			0.4624	0.4274
		0.4430	0.4212			0.4465	0.4071			0.4687	0.4289
		0.4385	0.4119			0.4418	0.3981			0.4634	0.4193
	8B4	0.4281	0.4006		8D4	0.4316	0.3873		9B4	0.4523	0.4085
		0.4322	0.4096			0.4359	0.3960			0.4573	0.4178
		0.4385	0.4119			0.4418	0.3981			0.4634	0.4193
		0.4342	0.4028			0.4373	0.3893			0.4582	0.4099



CCT	Bin ID	Chromaticity Coordinates	
		x	y
2700K	9C1	0.4582	0.4099
		0.4634	0.4193
		0.4695	0.4207
		0.4641	0.4112
	9C2	0.4634	0.4193
		0.4687	0.4289
		0.4750	0.4304
		0.4695	0.4207
	9C3	0.4695	0.4207
		0.4750	0.4304
		0.4813	0.4319
		0.4756	0.4221
	9C4	0.4641	0.4112
		0.4695	0.4207
		0.4756	0.4221
		0.4700	0.4126
	9D1	0.4483	0.3919
		0.4532	0.4008
		0.4589	0.4021
		0.4538	0.3931
	9D2	0.4532	0.4008
		0.4582	0.4099
		0.4641	0.4112
		0.4589	0.4021
	9D3	0.4589	0.4021
		0.4641	0.4112
		0.4700	0.4126
		0.4646	0.4034
9D4	0.4538	0.3931	
	0.4589	0.4021	
	0.4646	0.4034	
	0.4593	0.3944	

Tolerance = ±0.01

Figure 2: Chromaticity Diagram (4500K-8000K)

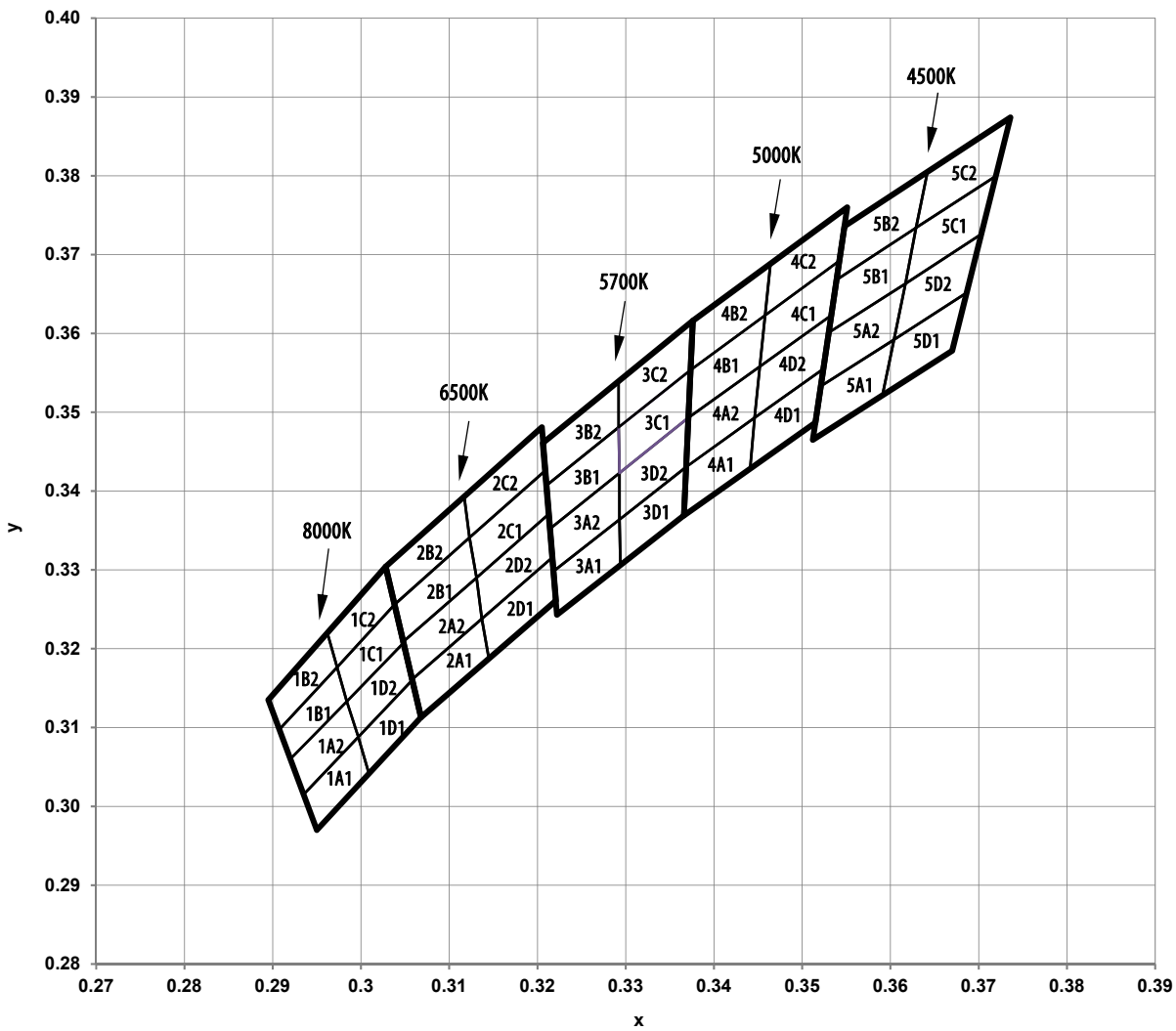

Figure 3: Chromaticity Diagram (2700K-4000K)

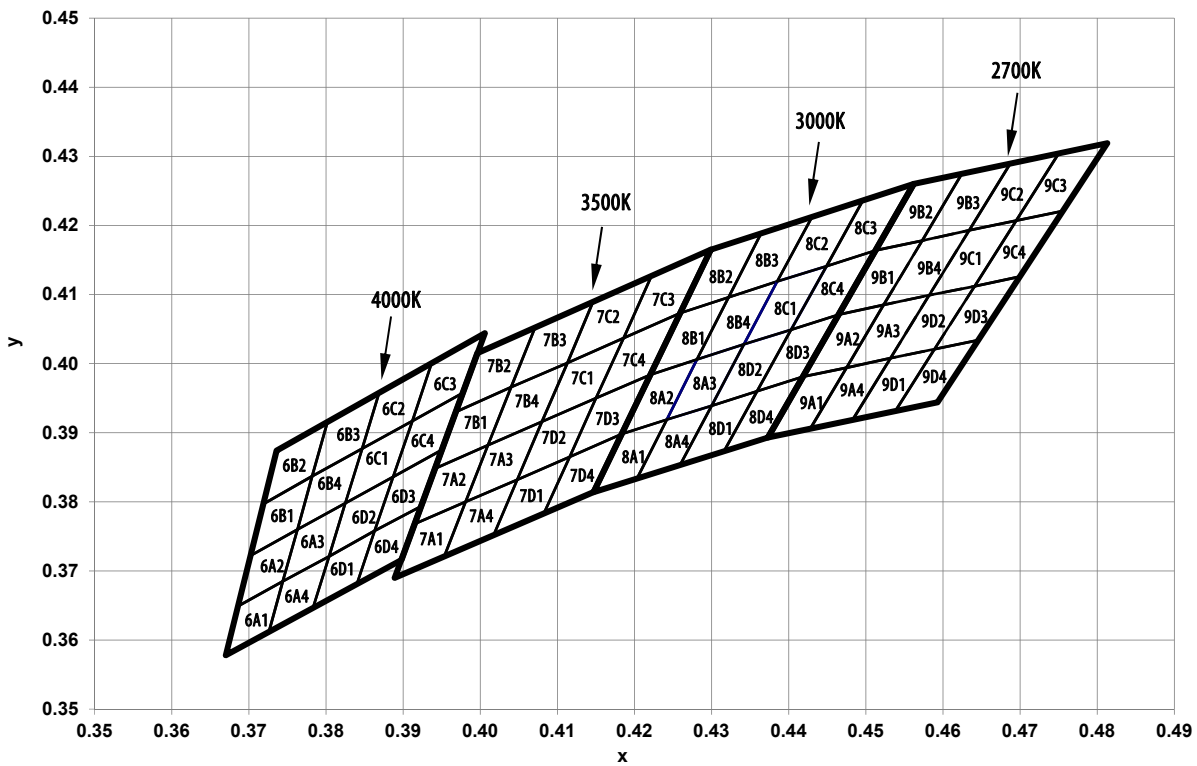

Figure 4: Spectral Power Distribution

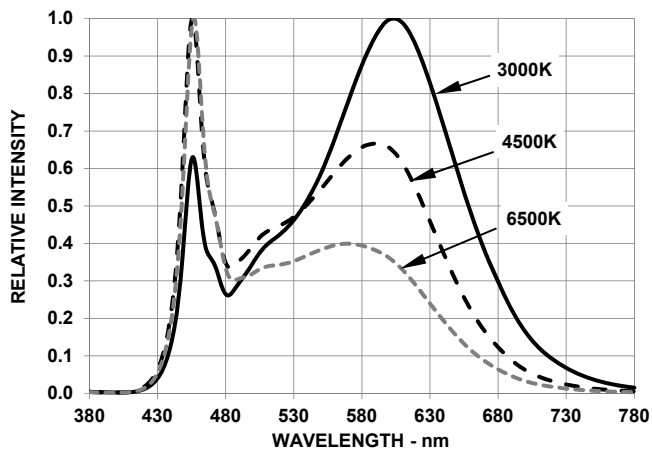

Figure 5: Forward Current vs. Forward Voltage

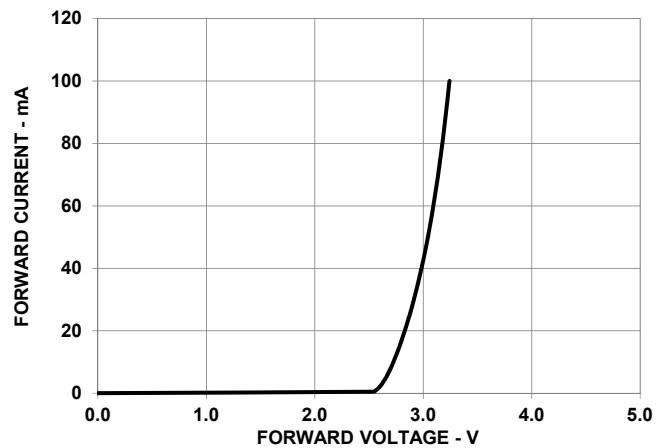

Figure 6: Relative Luminous Intensity vs. Mono Pulse Current

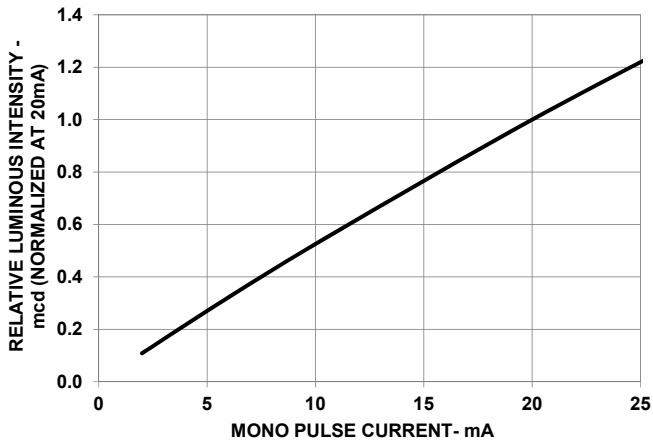

Figure 7: Radiation Pattern

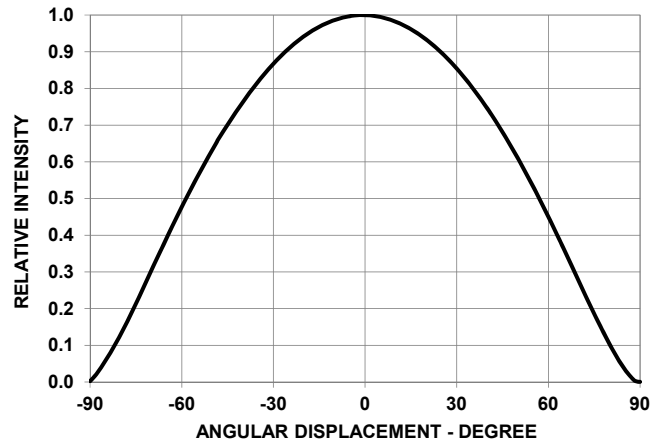

Figure 8: Chromaticity Coordinate Shift vs. Mono Pulse Current (3000K)

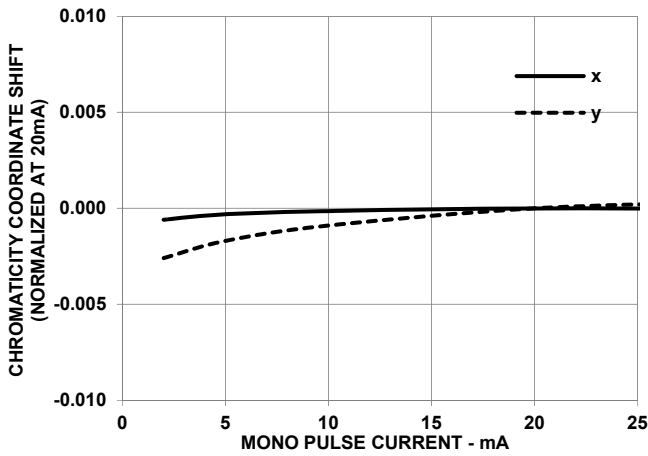

Figure 9: Chromaticity Coordinate Shift vs. Mono Pulse Current (4500K)

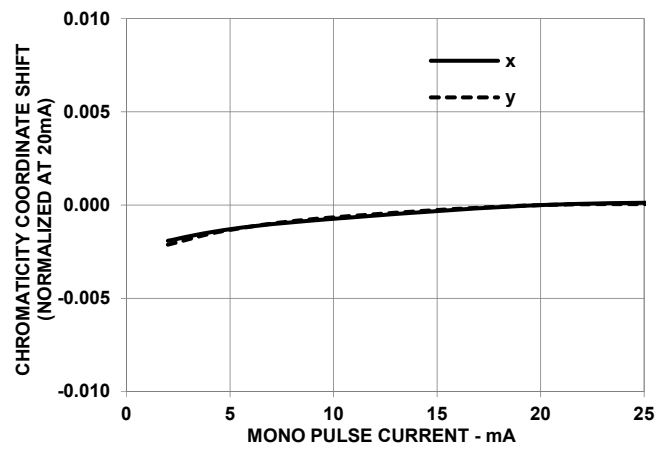

Figure 10: Chromaticity Coordinate Shift vs. Mono Pulse Current (6500K)

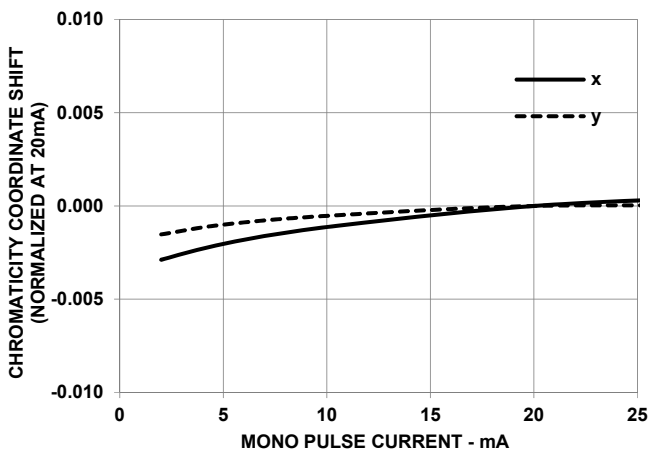
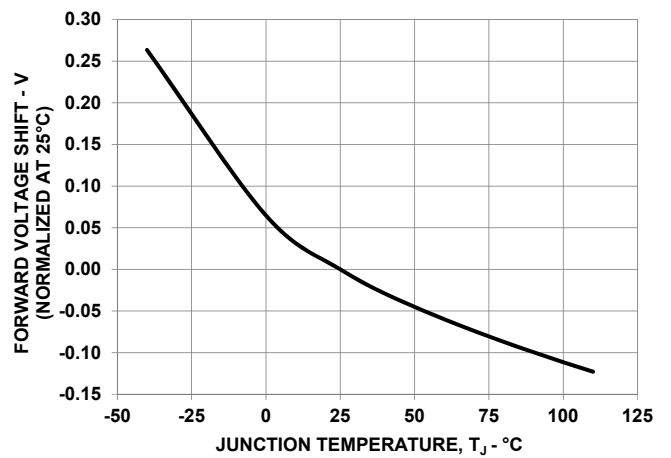
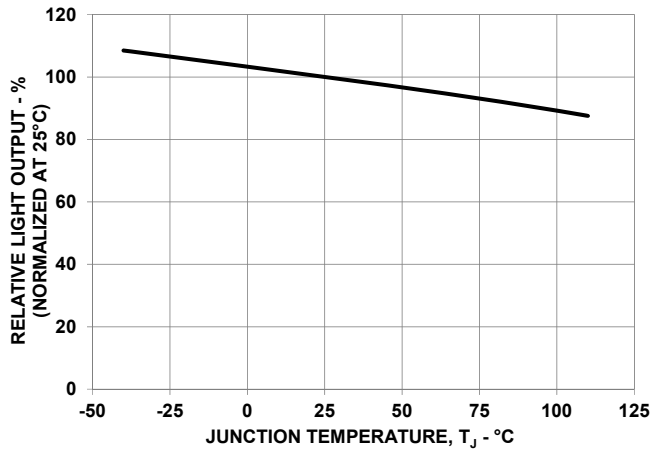

Figure 11: Forward Voltage Shift vs. Junction Temperature



**Figure 12: Relative Luminous Intensity vs. Junction Temperature**



**Figure 13: Chromaticity Coordinate Shift vs. Junction Temperature (3000K)**

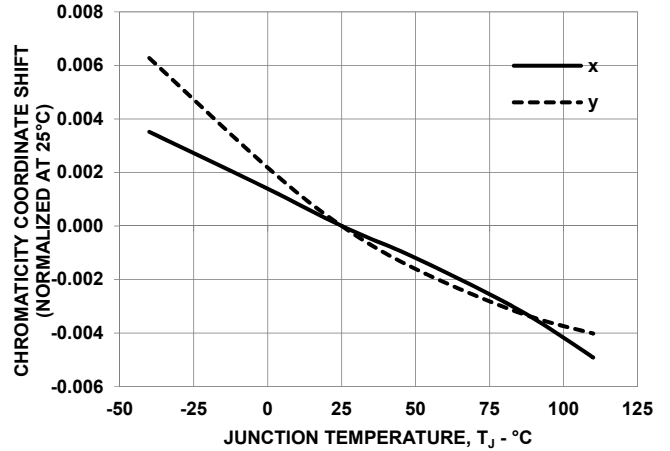

**Figure 14: Chromaticity Coordinate Shift vs. Junction Temperature (4500K)**

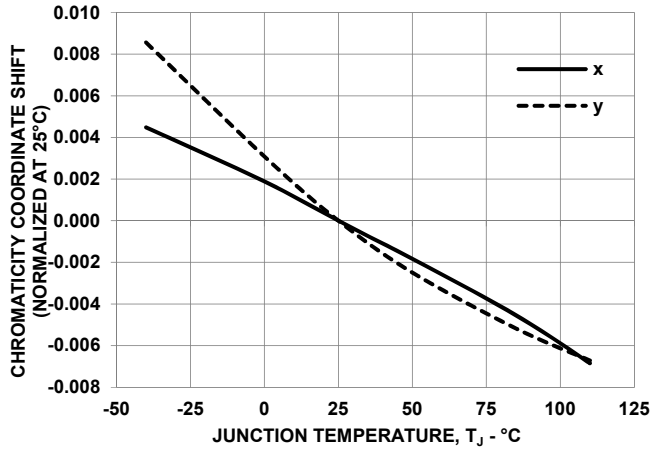

**Figure 15: Chromaticity Coordinate Shift vs. Junction Temperature (6500K)**

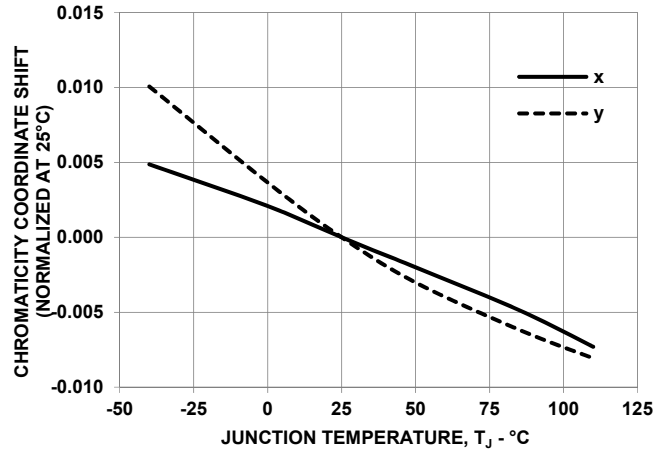

**Figure 16: Maximum Forward Current vs. Ambient Temperature. Derated based on  $T_{JMAX} = 110^\circ\text{C}$**

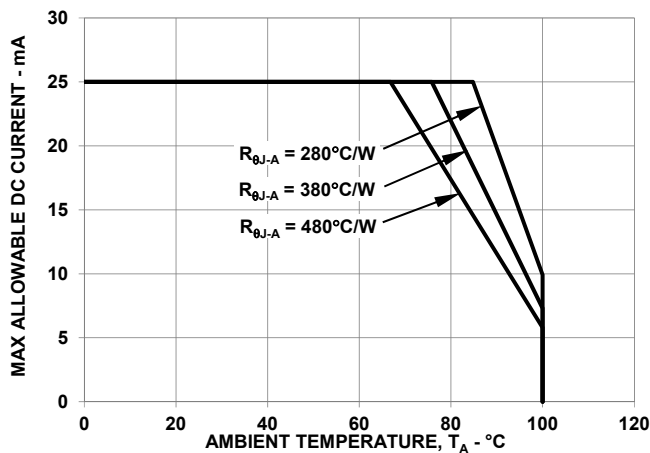

**Figure 17: Maximum Forward Current vs. Solder Point Temperature. Derated based on  $T_{JMAX} = 110^\circ\text{C}$ ,  $R_{\theta J-S} = 80^\circ\text{C/W}$**

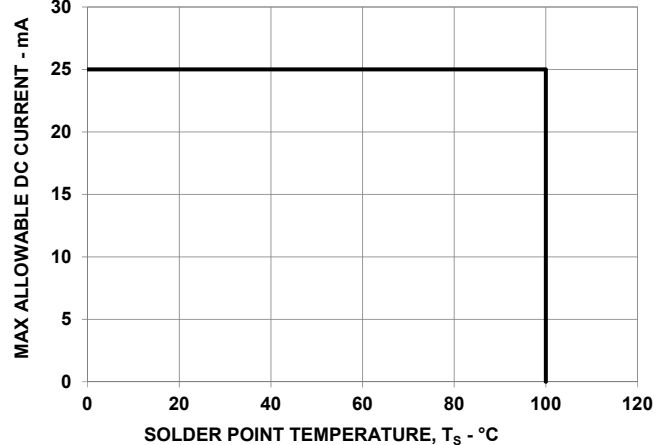
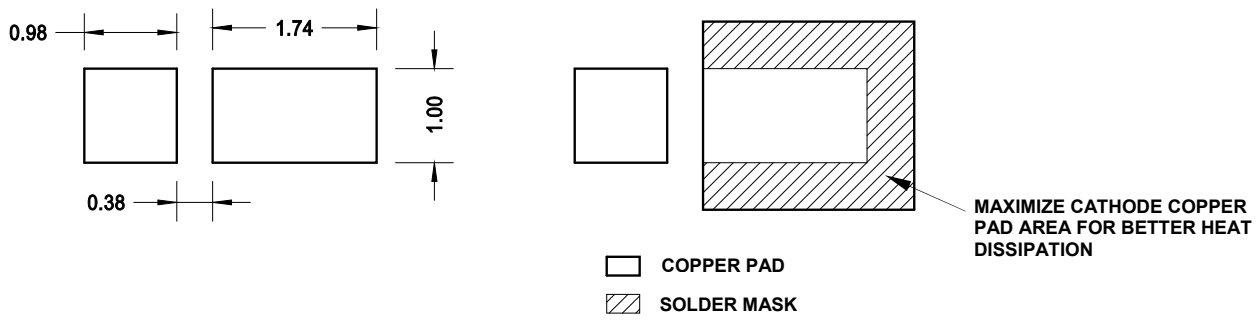
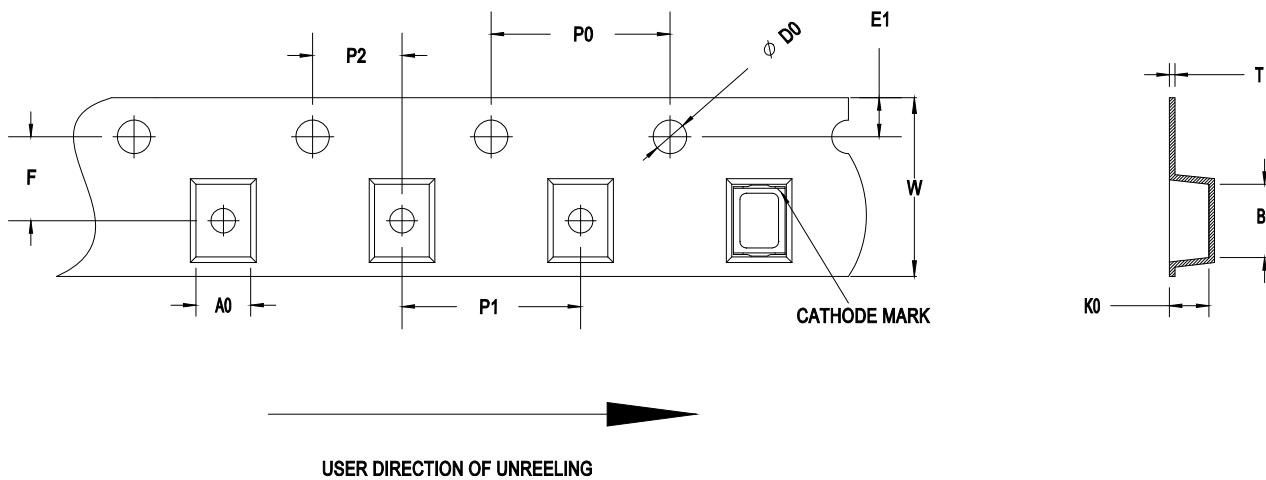

Figure 18: Recommended Soldering Land Pattern



NOTE: All dimensions are in millimeters (mm).

Figure 19: Carrier Tape Dimensions



F	P0	P1	P2	D0	E1	W
3.5±0.10	4.0±0.1	4.0±0.1	2.0±0.05	1.55±0.05	1.75±0.1	8.0±0.3

T	B0	K0	A0
0.23±0.05	2.3±0.1	1.0±0.1	1.75±0.1

NOTE:

- All dimensions in millimeters (mm).

Figure 20: Reel Dimensions

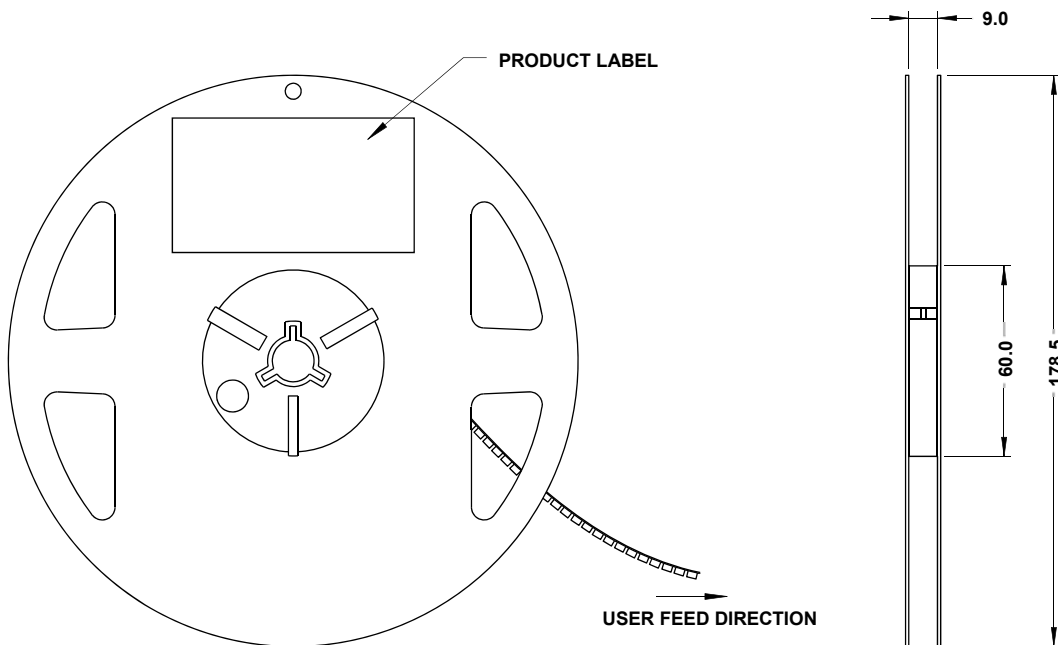

**NOTE:** All dimensions are in millimeters (mm).

## Precautionary Notes

### Soldering

- Do not perform reflow soldering more than twice. Observe necessary precautions of handling moisture-sensitive device as stated in the following section.
- Do not apply any pressure or force on the LED during reflow and after reflow when the LED is still hot.
- Use reflow soldering to solder the LED. Use hand soldering only for rework if unavoidable, but it must be strictly controlled to following conditions:
  - Soldering iron tip temperature = 315°C max.
  - Soldering duration = 3sec max.
  - Number of cycles = 1 only
  - Power of soldering iron = 50W max.
- Do not touch the LED package body with the soldering iron except for the soldering terminals, as it may cause damage to the LED.
- Confirm beforehand whether the functionality and performance of the LED is affected by soldering with hand soldering.

Figure 21: Recommended Lead-Free Reflow Soldering Profile

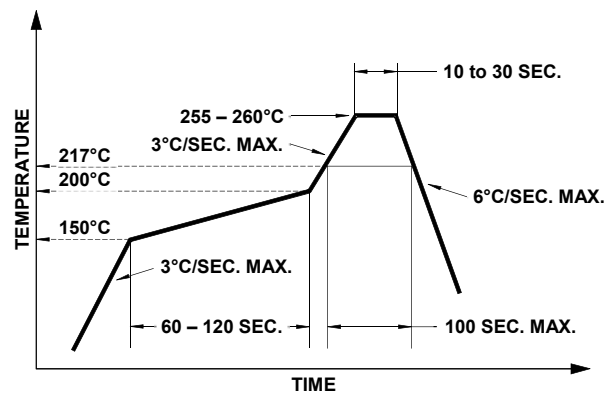
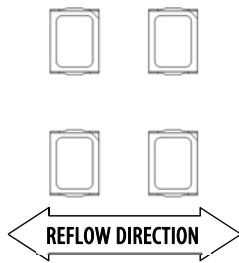

Figure 22: Recommended Board Reflow Direction



## Handling Precautions

The encapsulation material of the LED is made of silicone for better product reliability. Compared to epoxy encapsulant, which is hard and brittle, silicone is softer and flexible. Observe special handling precautions during assembly of silicone encapsulated LED products. Failure to comply might lead to damage and premature failure of the LED. Refer to Broadcom Application Note AN5288, *Silicone Encapsulation for LED: Advantages and Handling Precautions*, for additional information.

- Do not poke sharp objects into the silicone encapsulant. Sharp objects, such as tweezers or syringes, might apply excessive force or even pierce through the silicone and induce failures to the LED die or wire bond.
- Do not touch the silicone encapsulant. Uncontrolled force acting on the silicone encapsulant might result in excessive stress on the wire bond. Hold the LED only by the body.
- Do not stack assembled PCBs together. Use an appropriate rack to hold the PCBs.
- Surface of silicone material attracts dust and dirt easier than epoxy due to its surface tackiness. To remove foreign particles on the surface of silicone, use a cotton bud with isopropyl alcohol (IPA). During cleaning, rub the surface gently without putting too much pressure on the silicone. Ultrasonic cleaning is not recommended.
- For automated pick and place, Broadcom has tested a nozzle size with OD 1.5mm to work with this LED. However, due to the possibility of variations in other parameters such as pick and place machine maker/model, and other settings of the machine, verify that the selected nozzle will not cause damage to the LED.

## Handling of Moisture-Sensitive Devices

This product has a Moisture Sensitive Level 3 rating per JEDEC J-STD-020. Refer to Broadcom Application Note AN5305, *Handling of Moisture Sensitive Surface Mount Devices* for additional details and a review of proper handling procedures.

- Before use:
  - An unopened moisture barrier bag (MBB) can be stored at <math>40^{\circ}\text{C}/90\% \text{RH}</math> for 12 months. If the actual shelf life has exceeded 12 months and the Humidity Indicator Card (HIC) indicates that baking is not required, then it is safe to reflow the LEDs per the original MSL rating.
  - Do not open the MBB prior to assembly (for example, for IQC). If unavoidable, MBB must be properly resealed with fresh desiccant and HIC. The exposed duration must be taken in as floor life.
- Control after opening the MBB:
  - Read the HIC immediately upon opening of MBB.
  - Keep the LEDs at <math>30^{\circ}/60\% \text{RH}</math> at all times, and complete all high temperature-related processes, including soldering, curing or rework within 168 hours.
- Control for unfinished reel:
 

Store unused LEDs in a sealed MBB with desiccant or a desiccator at <math>5\% \text{RH}</math>.
- Control of assembled boards:
 

If the PCB soldered with the LEDs is to be subjected to other high-temperature processes, store the PCB in a sealed MBB with desiccant or desiccator at <math>5\% \text{RH}</math> to ensure that all LEDs have not exceeded their floor life of 168 hours.
- Baking is required if:
  - The HIC indicator indicates a change in color for 10% and 5%, as stated on the HIC.
  - The LEDs are exposed to conditions of <math>30^{\circ}\text{C}/60\% \text{RH}</math> at any time.
  - The LED's floor life exceeded 168 hours.

The recommended baking condition is: <math>60\pm 5^{\circ}\text{C}</math> for 20 hours.

Baking can only be done once.
- Storage:
 

The soldering terminals of these Broadcom LEDs are silver plated. If the LEDs are exposed in ambient environment for too long, the silver plating might be oxidized, thus affecting its solderability performance.



As such, keep unused LEDs in a sealed MBB with desiccant or in a desiccator at <5% RH.

### Application Precautions

- The drive current of the LED must not exceed the maximum allowable limit across temperature as stated in the data sheet. Constant current driving is recommended to ensure consistent performance.
- Circuit design must cater to the whole range of forward voltage ( $V_F$ ) of the LEDs to ensure the intended drive current can always be achieved.
- The LED exhibits slightly different characteristics at different drive currents, which may result in a larger variation of performance (meaning: intensity, wavelength, and forward voltage). Set the application current as close as possible to the test current to minimize these variations.
- Do not use the LED in the vicinity of material with sulfur content or in environments of high gaseous sulfur compounds and corrosive elements. Examples of material that might contain sulfur are rubber gaskets, room- temperature vulcanizing (RTV) silicone rubber, rubber gloves, and so on. Prolonged exposure to such environments may affect the optical characteristics and product life.
- White LEDs must not be exposed to acidic environments and must not be used in the vicinity of any compound that may have acidic outgas, such as, but not limited to, acrylate adhesive. These environments have an adverse effect on LED performance.
- Avoid rapid change in ambient temperature, especially in high-humidity environments, because they cause condensation on the LED.
- If the LED is intended to be used in harsh or outdoor environment, protect the LED against damages caused by rain, water, dust, oil, corrosive gases, external mechanical stresses, and so on.

### Thermal Management

The optical, electrical, and reliability characteristics of the LED are affected by temperature. Keep the junction temperature ( $T_J$ ) of the LED below the allowable limit at all times.  $T_J$  can be calculated as follows:

$$T_J = T_A + R_{\theta J-A} \times I_F \times V_{Fmax}$$

where:

$T_A$  = ambient temperature ( $^{\circ}C$ )

$R_{\theta J-A}$  = thermal resistance from LED junction to ambient ( $^{\circ}C/W$ )

$I_F$  = forward current (A)

$V_{Fmax}$  = maximum forward voltage (V)

The complication of using this formula lies in  $T_A$  and  $R_{\theta J-A}$ . Actual  $T_A$  is sometimes subjective and hard to determine.  $R_{\theta J-A}$  varies from system to system depending on design and is usually not known.

Another way of calculating  $T_J$  is by using the solder point temperature,  $T_S$  as follows:

$$T_J = T_S + R_{\theta J-S} \times I_F \times V_{Fmax}$$

where:

$T_S$  = LED solder point temperature as shown in the following figure ( $^{\circ}C$ )

$R_{\theta J-S}$  = thermal resistance from junction to solder point ( $^{\circ}C/W$ )

$I_F$  = forward current (A)

$V_{Fmax}$  = maximum forward voltage (V)

**Figure 23: Solder Point Temperature on PCB**

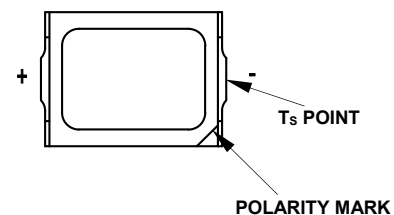

$T_S$  can be easily measured by mounting a thermocouple on the soldering joint as shown in preceding figure, while  $R_{\theta J-S}$  is provided in the data sheet. Verify the  $T_S$  of the LED in the final product to ensure that the LEDs are operating within all maximum ratings stated in the data sheet.

### Eye Safety Precautions

LEDs may pose optical hazards when in operation. Do not look directly at operating LEDs because it might be harmful to the eyes. For safety reasons, use appropriate shielding or personal protective equipment.

## Disclaimer

Broadcom's products and software are not specifically designed, manufactured, or authorized for sale as parts, components, or assemblies for the planning, construction, maintenance, or direct operation of a nuclear facility or for use in medical devices or applications. The customer is solely responsible, and waives all rights to make claims against Broadcom or its suppliers, for all loss, damage, expense, or liability in connection with such use.

Broadcom, the pulse logo, Connecting everything, Avago Technologies, Avago, and the A logo are among the trademarks of Broadcom and/or its affiliates in the United States, certain other countries and/or the EU.

Copyright © 2020 by Broadcom. All Rights Reserved.

The term "Broadcom" refers to Broadcom Inc. and/or its subsidiaries. For more information, please visit [www.broadcom.com](http://www.broadcom.com).

Broadcom reserves the right to make changes without further notice to any products or data herein to improve reliability, function, or design. Information furnished by Broadcom is believed to be accurate and reliable. However, Broadcom does not assume any liability arising out of the application or use of this information, nor the application or use of any product or circuit described herein, neither does it convey any license under its patent rights nor the rights of others.

