

BLF 7.62HP/03/180F SN BK BX
Weidmüller Interface GmbH & Co. KG

Klingenbergstraße 26

D-32758 Detmold

Germany

www.weidmueller.com

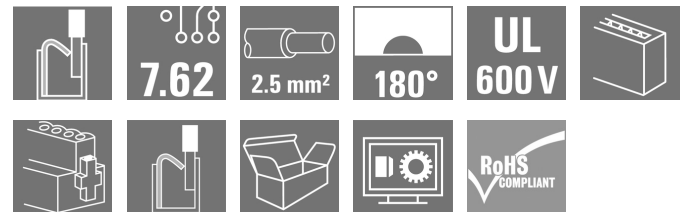
Product image

180° female header with PUSH-IN connection technology for field wiring in 2.5 mm² with a 7.62 pitch.

Meets the requirements as per UL1059 600 V class C and IEC 61800-5-1

Variants: without flange, external flange, release latch.

General ordering data

Version	PCB plug-in connector, female plug, 7.62 mm, Number of poles: 3, 180°, PUSH IN with actuator, Clamping range, max. : 2.5 mm ² , Box
Order No.	1043920000
Type	BLF 7.62HP/03/180F SN BK BX
GTIN (EAN)	4032248775460
Qty.	54 pc(s).
Product data	IEC: 1000 V / 29 A / 0.5 - 2.5 mm ² UL: 600 V / 20 A / AWG 20 - AWG 12
Packaging	Box

Creation date May 31, 2024 2:00:21 PM CEST

Catalogue status 18.05.2024 / We reserve the right to make technical changes.

BLF 7.62HP/03/180F SN BK BX
Weidmüller Interface GmbH & Co. KG

Klingenbergstraße 26

D-32758 Detmold

Germany

www.weidmueller.com

Technical data
Dimensions and weights

Depth	28.1 mm	Depth (inches)	1.106 inch
Height	15.1 mm	Height (inches)	0.594 inch
Width	31.84 mm	Width (inches)	1.254 inch
Net weight	9.44 g		

System Parameters

Product family	OMNIMATE Power - series BL/SL 7.62HP	Type of connection	Field connection
Wire connection method	PUSH IN with actuator	Pitch in mm (P)	7.62 mm
Pitch in inches (P)	0.3 "	Conductor outlet direction	180°
Number of poles	3	L1 in mm	15.24 mm
L1 in inches	0.6 "	Number of rows	1
Pin series quantity	1	Rated cross-section	2.5 mm ²
Touch-safe protection acc. to DIN VDE 57 106	Safe from finger touch	Touch-safe protection acc. to DIN VDE 0470	IP 20
Protection degree	IP20	Can be coded	Yes
Stripping length	10 mm	Tightening torque for screw flange, min.	0.15 Nm
Tightening torque for screw flange, max.	0.25 Nm	Screwdriver blade	0.6 x 3.5
Plugging cycles	25	Plugging force/pole, max.	8.5 N
Pulling force/pole, max.	6 N		

Material data

Insulating material	PBT	Colour	black
Colour chart (similar)	RAL 9011	Insulating material group	IIIa
Comparative Tracking Index (CTI)	≥ 200	Insulation strength	≥ 10 ⁸ Ω
UL 94 flammability rating	V-0	Contact material	Cu-alloy
Contact surface	tinned	Layer structure of plug contact	4...8 μm Sn hot-dip tinned
Storage temperature, min.	-40 °C	Storage temperature, max.	70 °C
Operating temperature, min.	-50 °C	Operating temperature, max.	100 °C
Temperature range, installation, min.	-25 °C	Temperature range, installation, max.	100 °C

Conductors suitable for connection

Clamping range, min.	0.08 mm ²
Clamping range, max.	2.5 mm ²
Wire connection cross section AWG, min.	AWG 20
Wire connection cross section AWG, max.	AWG 12
Solid, min. H05(07) V-U	0.5 mm ²
Solid, max. H05(07) V-U	1.5 mm ²
Flexible, min. H05(07) V-K	0.5 mm ²
Flexible, max. H05(07) V-K	2.5 mm ²
w. plastic collar ferrule, DIN 46228 pt 4, 0.5 mm ² min.	
w. plastic collar ferrule, DIN 46228 pt 4, 2.5 mm ² max.	
w. wire end ferrule, DIN 46228 pt 1, min.	0.5 mm ²
w. wire end ferrule, DIN 46228 pt 1, max.	2.5 mm ²
Plug gauge in accordance with EN 60999 a x b; ø	2.8 mm x 2.0 mm

Creation date May 31, 2024 2:00:21 PM CEST

Catalogue status 18.05.2024 / We reserve the right to make technical changes.

2

BLF 7.62HP/03/180F SN BK BX

Weidmüller Interface GmbH & Co. KG
 Klingenbergstraße 26
 D-32758 Detmold
 Germany

www.weidmueller.com

Technical data

Clampable conductor	Cross-section for conductor connection	Type	fine-wired	
		nominal	0.5 mm ²	
	wire end ferrule	Stripping length	nominal	12 mm
		Recommended wire-end ferrule	H0.5/16 OR	
		Stripping length	nominal	10 mm
		Recommended wire-end ferrule	H0.5/10	
	Cross-section for conductor connection	Type	fine-wired	
		nominal	0.75 mm ²	
	wire end ferrule	Stripping length	nominal	12 mm
		Recommended wire-end ferrule	H0.75/16 W	
		Stripping length	nominal	10 mm
		Recommended wire-end ferrule	H0.75/10	
	Cross-section for conductor connection	Type	fine-wired	
		nominal	1 mm ²	
	wire end ferrule	Stripping length	nominal	12 mm
		Recommended wire-end ferrule	H1.0/16D R	
		Stripping length	nominal	10 mm
		Recommended wire-end ferrule	H1.0/10	
	Cross-section for conductor connection	Type	fine-wired	
		nominal	1.5 mm ²	
wire end ferrule	Stripping length	nominal	10 mm	
	Recommended wire-end ferrule	H1.5/10		
	Stripping length	nominal	12 mm	
	Recommended wire-end ferrule	H1.5/16 R		
Cross-section for conductor connection	Type	fine-wired		
	nominal	2.5 mm ²		
wire end ferrule	Stripping length	nominal	10 mm	
	Recommended wire-end ferrule	H2.5/10		

Reference text The outside diameter of the plastic collar should not be larger than the pitch (P), Length of ferrules is to be chosen depending on the product and the rated voltage.

Rated data acc. to IEC

tested acc. to standard	IEC 60664-1, IEC 61984	Rated current, min. number of poles (Tu=20°C)	29 A
Rated current, max. number of poles (Tu=20°C)	24 A	Rated current, min. number of poles (Tu=40°C)	23.8 A
Rated current, max. number of poles (Tu=40°C)	23 A	Rated voltage for surge voltage class / pollution degree II/2	1,000 V
Rated voltage for surge voltage class / pollution degree III/2	1,000 V	Rated voltage for surge voltage class / pollution degree III/3	630 V
Rated impulse voltage for surge voltage class/ pollution degree II/2	6 kV	Rated impulse voltage for surge voltage class/ pollution degree III/2	8 kV
Rated impulse voltage for surge voltage class/ contamination degree III/3	6 kV	Short-time withstand current resistance	3 x 1s with 180 A
Clearance, min.	11.4 mm	Creepage distance, min.	11.4 mm

BLF 7.62HP/03/180F SN BK BX

Weidmüller Interface GmbH & Co. KG
 Klingenbergstraße 26
 D-32758 Detmold
 Germany

www.weidmueller.com

Technical data

Rated data acc. to CSA

Institute (CSA)		Certificate No. (CSA)	
		200039-1121690	
Rated voltage (Use group B / CSA)	600 V	Rated voltage (Use group C / CSA)	600 V
Rated voltage (Use group D / CSA)	600 V	Rated current (Use group B / CSA)	20 A
Rated current (Use group C / CSA)	20 A	Rated current (Use group D / CSA)	5 A
Wire cross-section, AWG, min.	AWG 20	Wire cross-section, AWG, max.	AWG 12
Reference to approval values	Specifications are maximum values, details - see approval certificate.		

Rated data acc. to UL 1059

Institute (cURus)		Certificate No. (cURus)	
		E60693	
Rated voltage (Use group B / UL 1059)	600 V	Rated voltage (Use group C / UL 1059)	600 V
Rated voltage (Use group D / UL 1059)	600 V	Rated current (Use group B / UL 1059)	20 A
Rated current (Use group C / UL 1059)	20 A	Rated current (Use group D / UL 1059)	5 A
Wire cross-section, AWG, min.	AWG 20	Wire cross-section, AWG, max.	AWG 12
Reference to approval values	Specifications are maximum values, details - see approval certificate.		

Packing

Packaging	Box	VPE length	352 mm
VPE width	136 mm	VPE height	36 mm

Type tests

Test: Durability of markings	Standard	DIN EN 61984 section 7.3.2 / 09.02 taking pattern from DIN EN 60068-2-70 / 07.96
	Test	mark of origin, type identification, pitch, type of material, date clock
	Evaluation	available
	Test	durability
Test: Misengagement (Non-interchangeability)	Evaluation	passed
	Standard	DIN EN 61984 section 6.3 and 6.9.1 / 09.02, DIN EN 60512-13-5 / 11.08
	Test	180° turned with coding elements
	Evaluation	passed
	Test	180° turned without coding elements
	Evaluation	passed

BLF 7.62HP/03/180F SN BK BX

Weidmüller Interface GmbH & Co. KG
 Klingenbergstraße 26
 D-32758 Detmold
 Germany

www.weidmueller.com

Technical data

Test: Clampable cross section	Standard	DIN EN 60999-1 section 7 and 9.1 / 12.00, DIN EN 60947-1 section 8.2.4.5.1 / 04.08
	Conductor type	Type of conductor and solid 0.5 mm ² conductor cross-section
		Type of conductor and stranded 0.5 mm ² conductor cross-section
		Type of conductor and solid 2.5 mm ² conductor cross-section
		Type of conductor and stranded 2.5 mm ² conductor cross-section
		Type of conductor and AWG 20/1 conductor cross-section
		Type of conductor and AWG 20/19 conductor cross-section
		Type of conductor and AWG 14/1 conductor cross-section
		Type of conductor and AWG 12/19 conductor cross-section
Evaluation	passed	
Test for damage to and accidental loosening of conductors	Standard	DIN EN 60999-1 section 9.4 / 12.00
	Requirement	0.3 kg
	Conductor type	Type of conductor and H05V-U0.5 conductor cross-section
		Type of conductor and H05V-K0.5 conductor cross-section
		Type of conductor and AWG 20/1 conductor cross-section
		Type of conductor and AWG 20/19 conductor cross-section
	Evaluation	passed
	Requirement	0.7 kg
	Conductor type	Type of conductor and H07V-U2.5 conductor cross-section
		Type of conductor and H07V-K2.5 conductor cross-section
		Type of conductor and AWG 14/1 conductor cross-section
	Evaluation	passed
	Requirement	0.9 kg
	Conductor type	Type of conductor and AWG 12/19 conductor cross-section
	Evaluation	passed

BLF 7.62HP/03/180F SN BK BX

Weidmüller Interface GmbH & Co. KG
 Klingenbergstraße 26
 D-32758 Detmold
 Germany

www.weidmueller.com

Technical data

Pull-out test	Standard	DIN EN 60999-1 section 9.5 / 12.00
	Requirement	≥20 N
	Conductor type	Type of conductor and H05V-U0.5 conductor cross-section
		Type of conductor and H05V-K0.5 conductor cross-section
		Type of conductor and AWG 20/1 conductor cross-section
		Type of conductor and AWG 20/19 conductor cross-section
	Evaluation	passed
	Requirement	≥50 N
	Conductor type	Type of conductor and H07V-U2.5 conductor cross-section
		Type of conductor and H07V-K2.5 conductor cross-section
		Type of conductor and AWG 14/1 conductor cross-section
	Evaluation	passed
	Requirement	≥60 N
	Conductor type	Type of conductor and AWG 12/19 conductor cross-section
	Evaluation	passed

Classifications

ETIM 6.0	EC002638	ETIM 7.0	EC002638
ETIM 8.0	EC002638	ETIM 9.0	EC002638
ECLASS 9.0	27-44-03-09	ECLASS 9.1	27-44-03-09
ECLASS 10.0	27-44-03-09	ECLASS 11.0	27-46-02-02
ECLASS 12.0	27-46-02-02	ECLASS 13.0	27-46-02-02

BLF 7.62HP/03/180F SN BK BX
Weidmüller Interface GmbH & Co. KG

Klingenbergstraße 26

D-32758 Detmold

Germany

www.weidmueller.com

Technical data
Important note

IPC conformity	Conformity: The products are developed, manufactured and delivered according international recognized standards and norms and comply with the assured properties in the data sheet resp. fulfill decorative properties in accordance with IPC-A-610 "Class 2". Further claims on the products can be evaluated on request.
Notes	<ul style="list-style-type: none"> • Additional variants on request • Gold-plated contact surfaces on request • Rated current related to rated cross-section & min. No. of poles. • Wire end ferrule without plastic collar to DIN 46228/1 • Wire end ferrule with plastic collar to DIN 46228/4 • P on drawing = pitch • Rated data refer only to the component itself. Clearance and creepage distances to other components are to be designed in accordance with the relevant application standards. • Crimping shape "A" for wire end ferrules with PZ 6/5 crimping tool recommended. • In accordance with IEC 61984, OMNIMATE-connectors are connectors without breaking capacity (COC). During designated use, connectors are not allowed to be engaged or disengaged when live or under load • Long term storage of the product with average temperature of 50 °C and maximum humidity 70%, 36 months

Approvals

Approvals



ROHS	Conform
UL File Number Search	UL Website
Certificate No. (cURus)	E60693

Downloads

Approval/Certificate/Document of Conformity	Declaration of the Manufacturer
Engineering Data	CAD data – STEP
User Documentation	Operating Instruction BLF QR-Code product handling video
Catalogues	Catalogues in PDF-format
Brochures	FL DRIVES EN MB DEVICE MANUF. EN FL DRIVES DE FL HEATING ELECTR EN FL APPL_INVERTER EN FL_BASE_STATION EN FL ELEVATOR EN FL POWER SUPPLY EN FL 72H SAMPLE SER EN PO OMNIMATE EN PO OMNIMATE EN

Creation date May 31, 2024 2:00:21 PM CEST

Catalogue status 18.05.2024 / We reserve the right to make technical changes.

7

BLF 7.62HP/03/180F SN BK BX

Weidmüller Interface GmbH & Co. KG
 Klingenbergstraße 26
 D-32758 Detmold
 Germany

www.weidmueller.com

Drawings

Product image

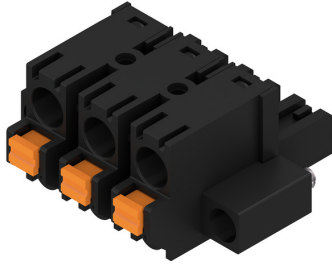

Dimensional drawing

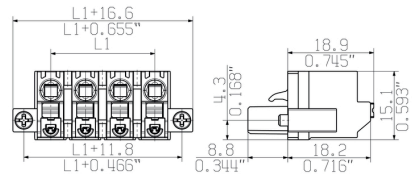

Graph

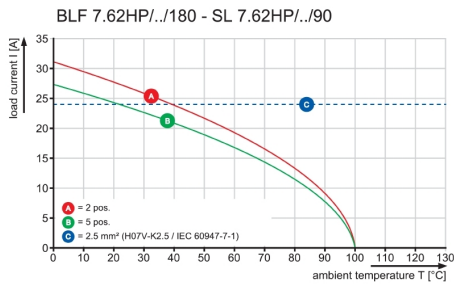

Graph

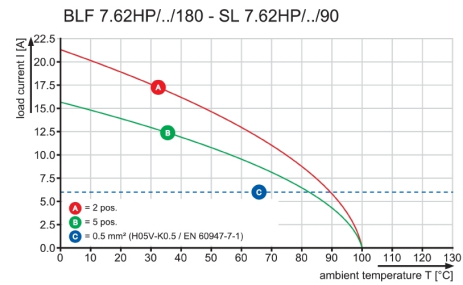

Product benefits



Vibration-proof connection

SHOWN: BLF7.62HP/04/ 180F

SHOWN: BLF7.62HP/04/ 180LR

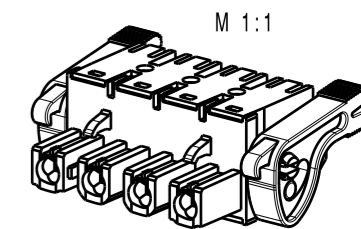

SHOWN: BLF7.62HP/04/ 180



2-POL. VERSION NUR DIESER HAKEN
2-POS. VERSION THIS HOOK ONLY

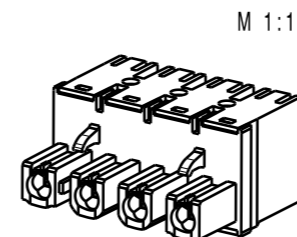
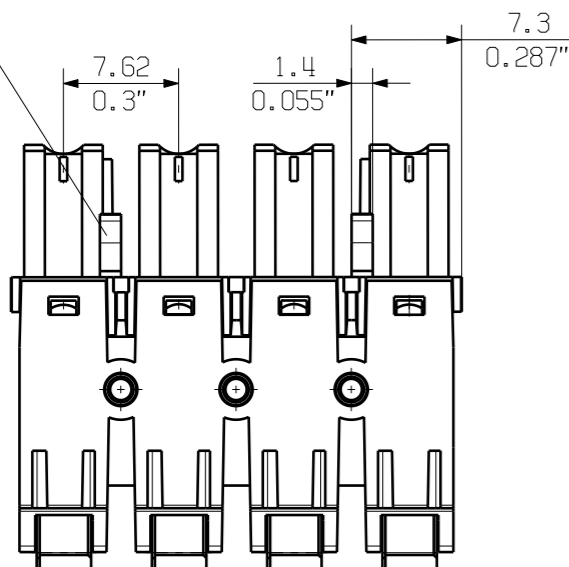

12	83,82	3,300
11	76,20	3,000
10	68,58	2,700
9	60,96	2,400
8	53,34	2,100
7	45,72	1,800
6	38,10	1,500
5	30,48	1,200
4	22,86	0,900
3	15,24	0,600
2	7,62	0,300
n	L1 [mm]	L1 [Inch]

For the mounting of PCBs, it should be noted that the rated data given in the catalogue relates only to the connection elements. The necessary creepage and clearance paths must be observed in connection with the respective applicant in accordance to VDE 0110. The current-carrying capacity and pitch tolerance is to be determined according to DIN IEC 326 part 3 very fine.

Weidmüller PCB components are tested to the DIN VDE 0627 standard, and are valid for its field of application. Provided that the components are used to the intended purpose, all requirements with respect to the occurring of electrical, mechanical, thermic and corrosive stress will be satisfied.

	97601/5 20.09.17 HELIS_MA 00		Cat.no.: .	
	GENERAL TOLERANCES DIN ISO 2768-m			
	Modification		3 46060	
	Drawn	Date	Name	Drawing no. 3 46060 Issue no. 07
	Responsible	24.04.2017	HELIS_MA	Sheet 01 of 02 sheets
Scale: 2:1	Checked	20.09.2017	HERTEL_S	BLF 7.62HP/././180 BUCHSENLEISTE SOCKET BLOCK
Supersedes: .	Approved	LANG_T	Product file: BLF/SLF 7.62	