

282107-1 ✓ ACTIVE

AMP | AMP Superseal 1.5mm Series

TE Internal #: 282107-1

Housing for Male Terminals, Wire-to-Wire, 5 Position, 6 mm [.236 in] Centerline, Sealable, Black, Wire & Cable, Signal, AMP

Superseal 1.5mm Series

[View on TE.com >](#)



Connectors > Automotive Connectors > Automotive Housings > AMP SUPERSEAL 1.5MM, CONNECTOR HOUSING

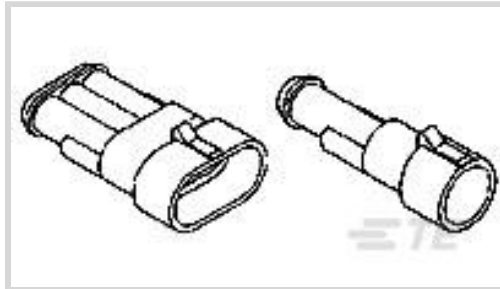

Connector System: **Wire-to-Wire**

Number of Positions: **5**

Connector & Housing Type: **Housing for Male Terminals**

Centerline (Pitch): **6 mm [.236 in]**

Sealable: **Yes**

[All AMP SUPERSEAL 1.5MM, CONNECTOR HOUSING \(27\)](#)

Features

Product Type Features

Mixed & Hybrid Connector	No
Connector Shape	Rectangular
Connector System	Wire-to-Wire
Connector & Housing Type	Housing for Male Terminals
Sealable	Yes
Connector & Contact Terminates To	Wire & Cable
Primary Locking Feature	Integrated in Housing

Configuration Features

Number of Positions	5
Number of Rows	1

Electrical Characteristics

Operating Voltage	24 VDC
Nominal Voltage Architecture	12 V, 24 V

Body Features

Cable Exit Angle	180°
Primary Product Color	Black
Connector & Keying Code	Neutral



Contact Features

Contact Size	1.5mm
Contact Type	Tab
Contact Current Rating (Max)	14 A

Mechanical Attachment

Terminal Position Assurance	Yes
Strain Relief	Without
Mating Alignment Type	Polarizing Rib
Mating Alignment	With
Connector Mounting Type	Cable Mount (Free-Hanging)

Housing Features

Housing Material	PA GF
Centerline (Pitch)	6 mm [.236 in]

Dimensions

Connector Height	42 mm [1.654 in]
Product Width	13.8 mm [.543 in]
Product Length	37.8 mm [1.488 in]

Usage Conditions

Operating Temperature (Max)	70 °C, 75 °C, 80 °C, 85 °C, 90 °C, 100 °C, 105 °C, 110 °C, 120 °C, 125 °C [158 °F][167 °F][176 °F][185 °F][194 °F][212 °F][221 °F][230 °F][248 °F][257 °F]
Operating Temperature Range	-40 – 125 °C [-40 – 257 °F]

Operation/Application

Circuit Application	Signal
---------------------	--------

Packaging Features

Packaging Quantity	700
Packaging Method	Box

Other

Serviceable	No
Connector Position Assurance Capable	No

Product Compliance

For compliance documentation, visit the product page on [TE.com](#)>

EU RoHS Directive 2011/65/EU	Compliant
EU ELV Directive 2000/53/EC	Compliant
China RoHS 2 Directive MIIT Order No 32, 2016	No Restricted Materials Above Threshold
EU REACH Regulation (EC) No. 1907/2006	Current ECHA Candidate List: JUNE 2024 (241) Candidate List Declared Against: JUNE 2024 (241) Does not contain REACH SVHC
Halogen Content	Low Halogen - Br, Cl, F, I < 900 ppm per homogenous material. Also BFR/CFR/PVC Free
Solder Process Capability	Not applicable for solder process capability

Product Compliance Disclaimer

This information is provided based on reasonable inquiry of our suppliers and represents our current actual knowledge based on the information they provided. This information is subject to change. The part numbers that TE has identified as EU RoHS compliant have a maximum concentration of 0.1% by weight in homogenous materials for lead, hexavalent chromium, mercury, PBB, PBDE, DBP, BBP, DEHP, DIBP, and 0.01% for cadmium, or qualify for an exemption to these limits as defined in the Annexes of Directive 2011/65/EU (RoHS2). Finished electrical and electronic equipment products will be CE marked as required by Directive 2011/65/EU. Components may not be CE marked. Additionally, the part numbers that TE has identified as EU ELV compliant have a maximum concentration of 0.1% by weight in homogenous materials for lead, hexavalent chromium, and mercury, and 0.01% for cadmium, or qualify for an exemption to these limits as defined in the Annexes of Directive 2000/53/EC (ELV). Regarding the REACH Regulation, the information TE provides on SVHC in articles for this part number is based on the latest European Chemicals Agency (ECHA) 'Guidance on requirements for substances in articles' posted at this URL: <https://echa.europa.eu/guidance-documents/guidance-on-reach>

Compatible Parts

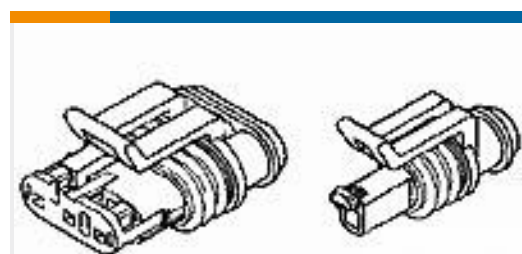

TE Part # 282089-1
AMP SUPERSEAL 1.5 SERIES 5P PL

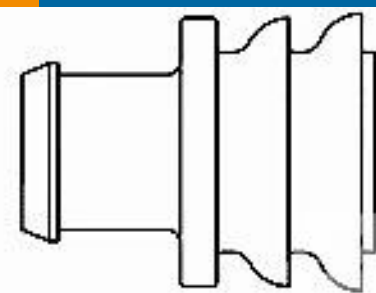

TE Part # 281934-3
SINGLE WIRE SEAL

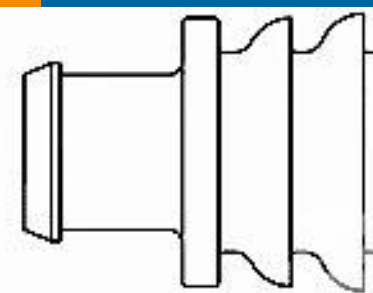

TE Part # 282081-1
RUBBER PLUG

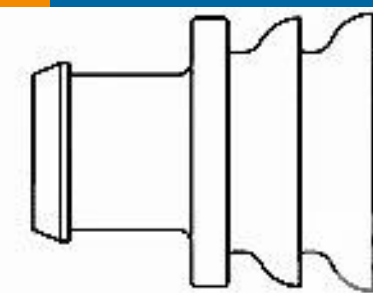

TE Part # 281934-2
SINGLE WIRE SEAL

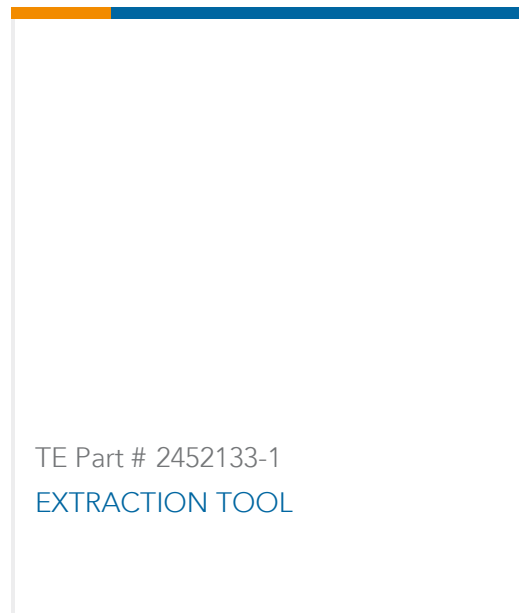
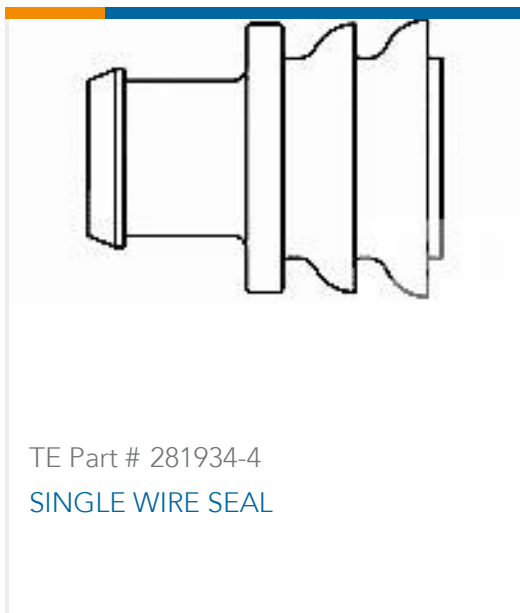

Also in the Series | AMP Superseal 1.5mm Series

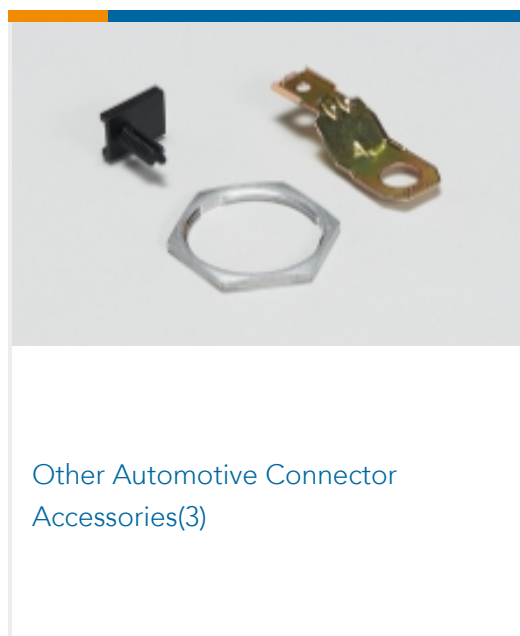
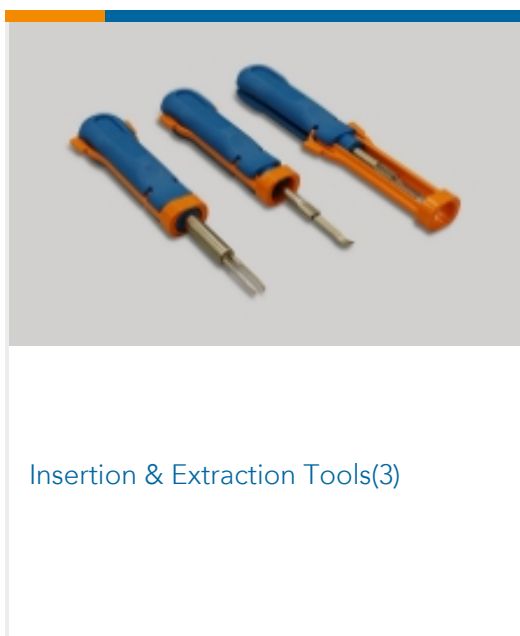
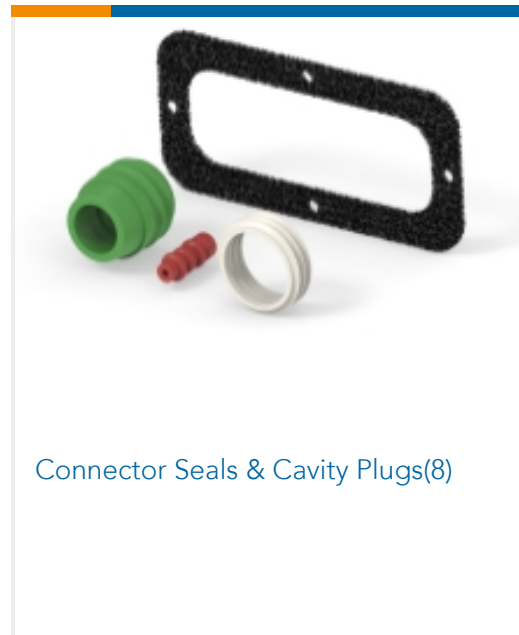
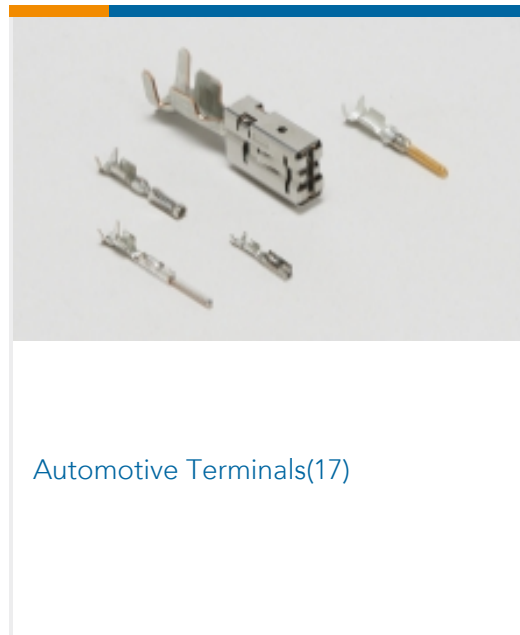
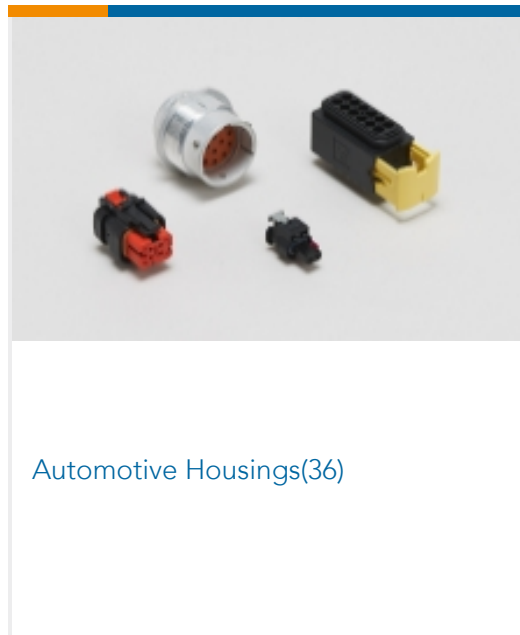
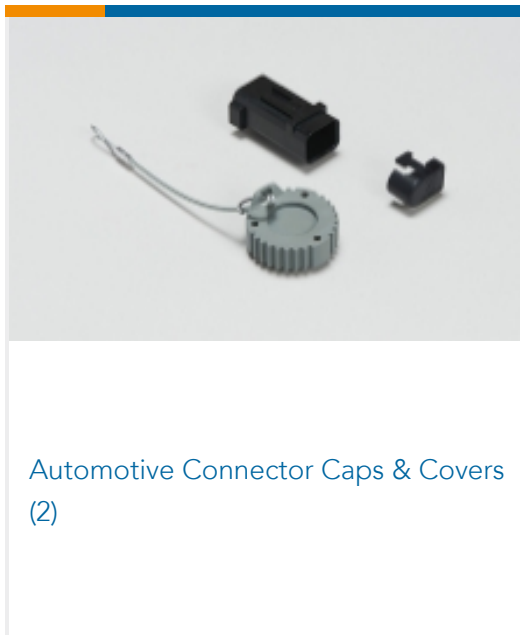

Customers Also Bought

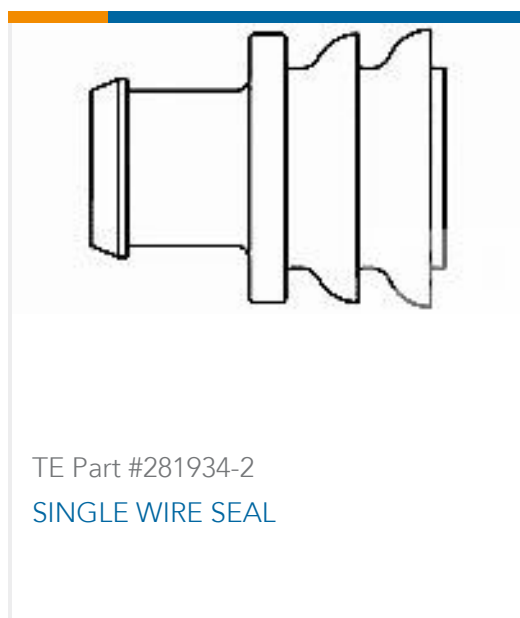

Documents

Product Drawings

AMP SUPERSEAL 1.5 SERIES 5P CA

English

CAD Files

3D PDF

English



Customer View Model

[ENG_CVM_282107-1_A2.2d_dxf.zip](#)

English

Customer View Model

[ENG_CVM_282107-1_A2.3d_igs.zip](#)

English

Customer View Model

[ENG_CVM_282107-1_A2.3d_stp.zip](#)

English

By downloading the CAD file I accept and agree to the [Terms and Conditions](#) of use.

Datasheets & Catalog Pages

[AMP SUPERSEAL 1.5mm Connector System](#)

English

[ICT Terminals and Connectors Catalogue](#)

English

Product Specifications

[Product Specification](#)

English

Instruction Sheets

[AMP SUPERSEAL 1.5 SERIES](#)

English

[Customer Manual \(non U.S.\)](#)

English