

## High-capacity Switch Capable of Handling 20 A Loads with Large Inrush Currents

- Same shape as OMRON Z Basic Switches except in pin plunger position, yet endures inrush currents as large as 75 A.



For the most recent information on models that have been certified for safety standards, refer to your OMRON website.

 Be sure to read *Safety Precautions* on page 5 and *Safety Precautions for All Basic Switches*.

## Model Number Structure

### Model Number Legend

**A - 20 G □ - □**  
(1) (2) (3) (4)

#### (1) Ratings

20 : 20 A (250 VAC)

#### (2) Contact Gap

G : 0.5 m











#### (3) Actuator

- None : Pin plunger
- D : Short spring plunger
- Q : Panel mount plunger
- Q21 : Panel mount cross roller plunger
- Q22 : Panel mount roller plunger
- V : Hinge lever
- V2 : Hinge roller lever
- V21 : Short hinge lever
- V22 : Short hinge roller lever

#### (4) Terminals

- None : Solder terminal
- B : Screw terminal (with toothed washer)

## Ordering Information

Actuator	Terminal	Solder terminal 	Screw terminal (-B) 
		Model	Model
Pin plunger		A-20G	A-20G-B
Short spring plunger		A-20GD	A-20GD-B
Panel mount plunger		A-20GQ	A-20GQ-B
Panel mount roller plunger		A-20GQ22	A-20GQ22-B
Panel mount cross roller plunger		---	A-20GQ21-B
Short hinge lever		A-20GV21	A-20GV21-B
Hinge lever		A-20GV	A-20GV-B
Short hinge roller lever		A-20GV22	A-20GV22-B
Hinge roller lever		A-20GV2	A-20GV2-B

## Specifications

### Ratings

Rated voltage (V)	Non-inductive load (A)				Inductive load (A)			
	Resistive load		Lamp load		Inductive load		Motor load	
	NC	NO	NC	NO	NC	NO	NC	NO
125 VAC	20		7.5		20		12.5	
250 VAC	20		7.5		20		8.3	
500 VAC	15		4		10		2	
8 VDC	20	3	1.5		20		12.5	
14 VDC	20	3	1.5		15		12.5	
30 VDC	6	3	1.5		5		5	
125 VDC	0.5	0.5	0.5		0.05		0.05	
250 VDC	0.25	0.25	0.25		0.03		0.03	

- Note: 1. The above values are for steady-state current.  
 2. Inductive load has a power factor of 0.4 min. (AC) and a time constant of 7 ms max. (DC).  
 3. Lamp load has an inrush current of 10 times the steady-state current.  
 4. Motor load has an inrush current of 6 times the steady-state current.  
 5. The ratings values apply under the following test conditions:  
 (1) Ambient temperature: 20±2°C  
 (2) Ambient humidity: 65±5%RH  
 (3) Operating frequency: 20 operations/min

### Certified Standard Ratings

Ask your OMRON representative for information on certified models. **UL/CSA (General ratings only)**

Rated voltage	Model	A-20G
125 VAC		1 HP 10 A "L"
250 VAC		2 HP
480 VAC		20 A
125 VDC		0.5 A
250 VDC		0.25 A

**Accessories - Terminal Covers, and Separators (Order Separately): Refer to Z/A/X/DZ Common Accessories.**

## Characteristics

<b>Operating speed</b>		0.01 mm to 1m/s *1
<b>Operating frequency</b>	<b>Mechanical</b>	240 operations/min
	<b>Electrical</b>	20 operations/min
<b>Insulation resistance</b>		100 MΩ min. (at 500 VDC)
<b>Contact resistance</b>		15 mΩ max. (initial value)
<b>Dielectric strength</b>		1,000 VAC, 50/60 Hz for 1 min between terminals of the same polarity 2,000 VAC, 50/60 Hz for 1 min between the current-carrying metal parts and the ground, and between each terminal and non-current-carrying metal parts
<b>Vibration resistance</b>	<b>Malfunction</b>	10 to 55 Hz, 1.5-mm double amplitude *2
<b>Shock resistance</b>	<b>Destruction</b>	1,000 m/s <sup>2</sup> max.
	<b>Malfunction</b>	300 m/s <sup>2</sup> max. *1 *2
<b>Durability</b>	<b>Mechanical</b>	1,000,000 operations min.
	<b>Electrical</b>	500,000 operations min.
<b>Degree of protection</b>		IP00
<b>Degree of protection against electric shock</b>		Class I
<b>Proof tracking index (PTI)</b>		175
<b>Ambient operating temperature</b>		-25°C to 80°C (with no icing)
<b>Ambient operating humidity</b>		35% to 85%RH
<b>Weight</b>		Approx. 22 to 58 g

\*1. The value is for the pin plunger. (Contact your OMRON representative for other models.)

\*2. Malfunction: 1 ms max.

## Contact Specification

<b>Contacts</b>	<b>Shape</b>	Rivet
	<b>Material</b>	Silver alloy
	<b>Gap (standard value)</b>	0.5 mm
<b>Inrush current</b>	<b>NC</b>	75 A max.
	<b>NO</b>	75 A max.

## Structure

### Contact Form (SPDT)

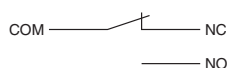

## Dimensions

(Unit: mm)

### Terminals

#### Screw Terminals (-B)

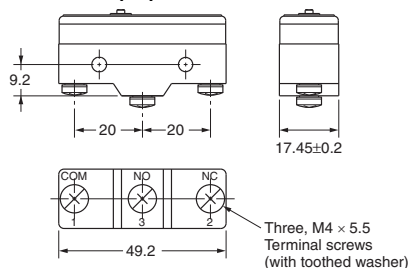

#### Solder Terminal (-A) ("A" is not included in the model numbers.)

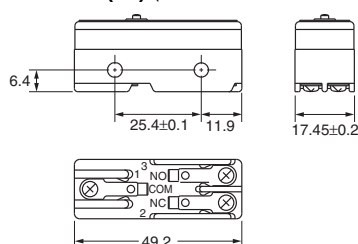

Note: 1. Appropriate terminal screw tightening torque: 0.78 to 1.18 N·m.  
2. Unless otherwise specified, a tolerance of ±0.4 mm applies to all dimensions.

## Engineering Data

### Mechanical Durability (A-20G)

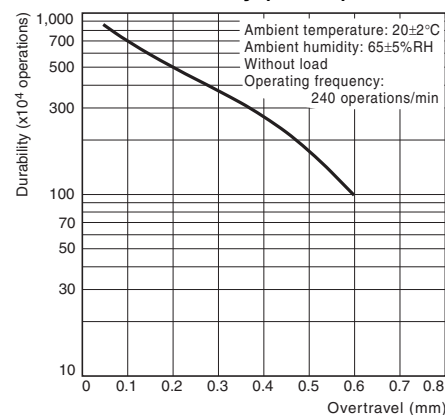

### Electrical Durability (A-20G)

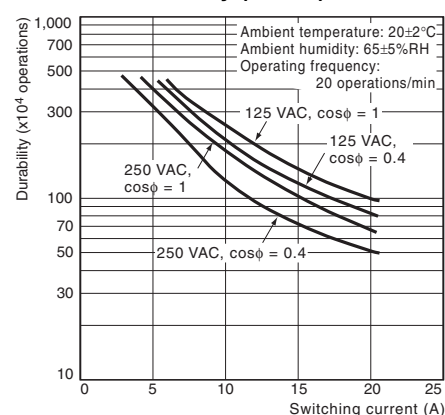

### Mounting Holes

Use M4 mounting screws with plane washers or spring washers to securely mount the Switch. Tighten the screws to a torque of 1.18 to 1.47 N·m.

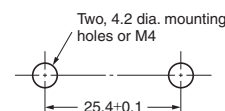

The Switch can be panel mounted, provided that the hexagonal nut of the actuator is tightened to a torque of 2.94 to 4.9 N·m.

#### Panel Mount Plunger

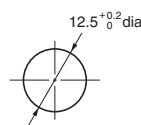

#### Panel Mount Roller Plunger

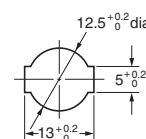

## Dimensions and Operating Characteristics

The models, illustrations, and graphics are for screw-terminal models. (The dimensions for models that are omitted here are the same as for pin-plunger models.)

### Pin Plunger A-20G-B

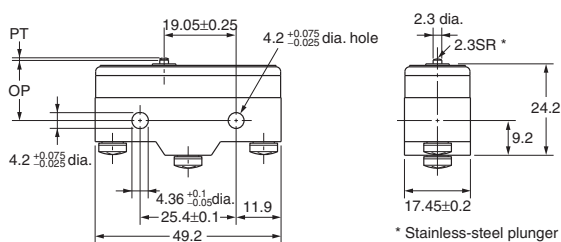
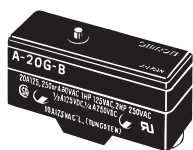

\* Stainless-steel plunger

### Short Spring Plunger A-20GD-B

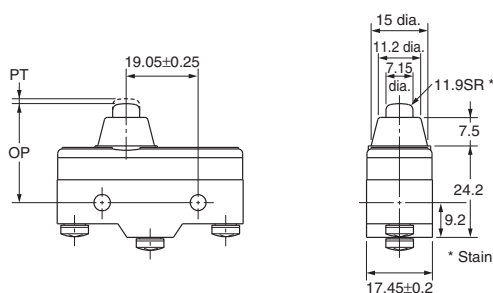
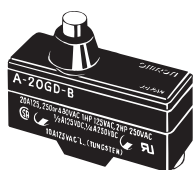

\* Stainless-steel plunger

### Panel Mount Plunger A-20GQ-B

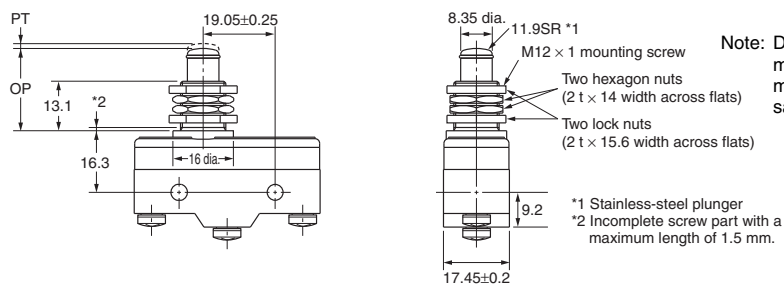
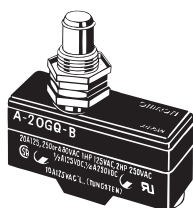

### Panel Mount Roller Plunger A-20GQ22-B

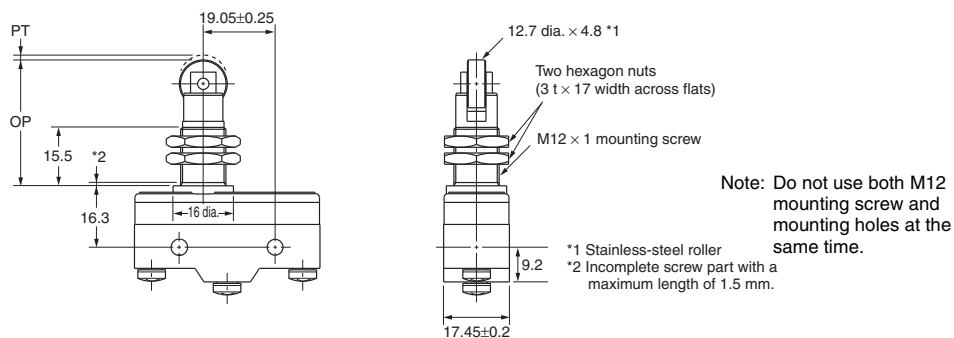
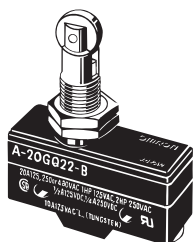

### Panel Mount Cross Roller Plunger A-20GQ21-B

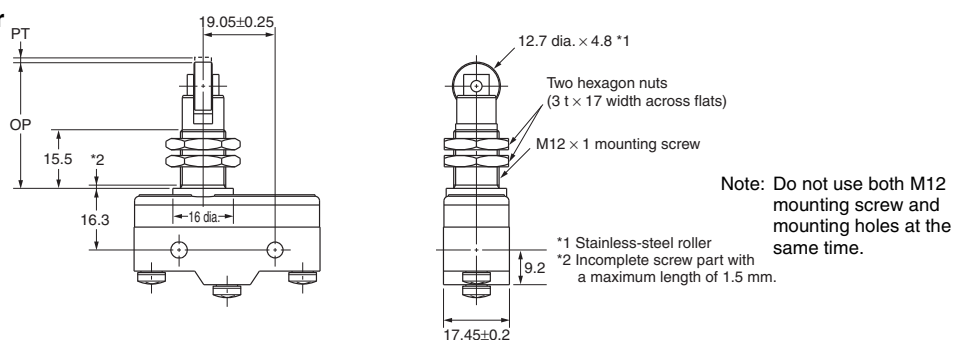
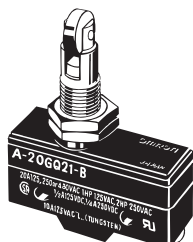

Note: Unless otherwise specified, a tolerance of ±0.4 mm applies to all dimensions.

Operating Characteristics	Model	A-20G-B	A-20GD-B	A-20GQ-B	A-20GQ22-B	A-20GQ21-B
Operating force	OF	3.92 to 6.13 N	3.92 to 6.13 N	3.92 to 6.13 N	6.18 N max.	6.18 N max.
Release force	RF min.	2.79 N	2.79 N	2.79 N	2.75 N	2.75 N
Pretravel	PT max.	1.3 mm	1.3 mm	1.3 mm	1.3 mm	1.3 mm
Over Travel	OT min.	0.25 mm	3 mm	5.6 mm	3.58 mm	3.58 mm
Movement differential	MD max.	0.2 mm	0.2 mm	0.2 mm	0.35 mm	0.35 mm
Operating Position	OP	16.3±0.4 mm	26.2±0.5 mm	21.8±0.8 mm	33.4±1.2 mm	33.4±1.2 mm

**Short Hinge Lever  
A-20GV21-B**

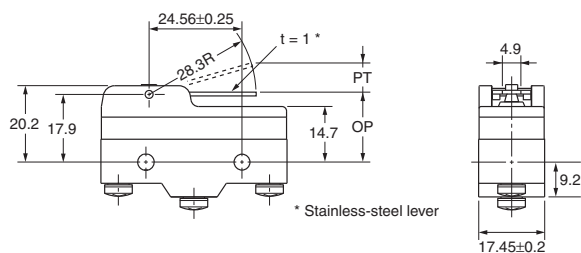
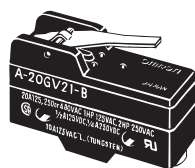

**Hinge Lever  
A-20GV-B**

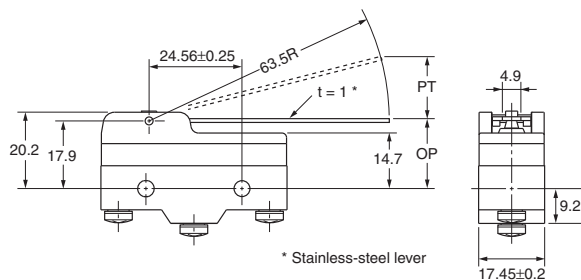
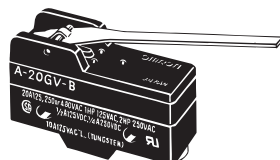

**Short Hinge Roller Lever  
A-20GV22-B**

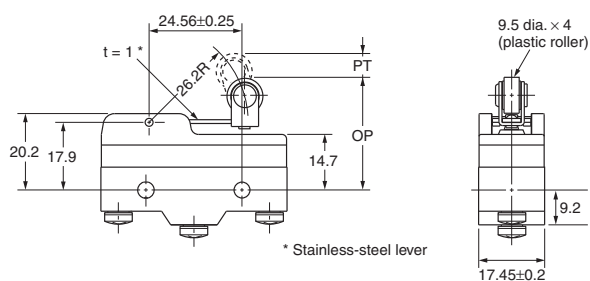

**Hinge Roller Lever  
A-20GV2-B**

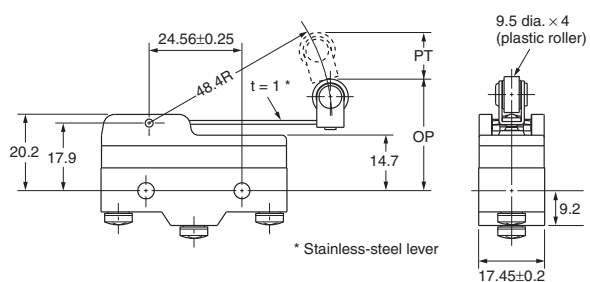
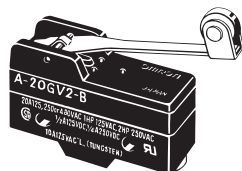

Note: Unless otherwise specified, a tolerance of  $\pm 0.4$  mm applies to all dimensions.

Operating Characteristics	Model	A-20GV21-B	A-20GV-B	A-20GV22-B	A-20GV2-B
OF max.		1.57 N	0.69 N	1.57 N	0.88 N
RF min.		0.41 N	0.14 N	0.41 N	0.14 N
PT max.		6.5 mm	15.9 mm	6.3 mm	12 mm
OT min.		1.2 mm	4 mm	1.2 mm	2.4 mm
MD max.		1.2 mm	2.4 mm	1.2 mm	2.2 mm
OP		19±0.8 mm	19±0.8 mm	29.8±0.8 mm	30.2±0.8 mm

## Safety Precautions

Refer to *Safety Precautions for All Basic Switches*.

### Precautions for Safe Use

#### Terminal Connection

When you wire a Switch, use a wire size that is suitable for the applied voltage and current flow. When soldering wires to the Switch, make sure that the capacity of the soldering iron is 60 W maximum and complete soldering within 5 s. If soldering is not performed correctly, heat may be abnormally generated when the Switch is used, which may cause burning. The characteristics of the Switch will deteriorate if a soldering iron with a capacity of more than 60 W is used or if heat is applied to the Switch for more than 5 s.

#### Operation

- Make sure that the switching frequency or speed is within the specified range.
  1. If the switching speed is extremely slow, the contact may not be switched smoothly, which may result in a contact failure or contact welding.
  2. If the switching speed is extremely fast, switching shock may damage the Switch soon. If the switching frequency is too high, the contact may not catch up with the speed.

The rated permissible switching speed and frequency indicate the switching reliability of the Switch.  
The life of a Switch is determined at the specified switching speed. The life varies with the switching speed and frequency even when they are within the permissible ranges. In order to determine the life of a Switch model to be applied to a particular use, it is best to conduct an appropriate durability test on some samples of the model under actual conditions.
- Make sure that the actuator travel does not exceed the permissible OT position. The operating stroke must be set to 70% to 100% of the rated OT.

### Precautions for Correct Use

#### Mounting Location

- Do not use the switch alone in atmospheres such as flammable or explosive gases. Arcing and heat generation associated with switching may cause fires or explosions.
- Switches are generally not constructed with resistance against water. Use a protective cover to prevent direct spraying if the switch is used in locations subject to splashing or spurting oil or water, dust adhering.

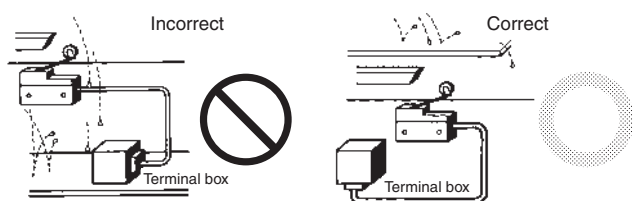

- Install the switch in a location that is not directly subject to debris and dust from cutting. The actuator and the switch body must be protected from accumulated cutting debris and dirt.

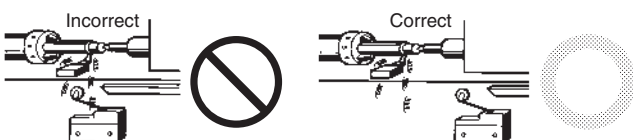

- Do not use the switch in locations subject to hot water (greater than 60°C) or in water vapor.
- Do not use the switch outside the specified temperature and atmospheric conditions.

The permissible ambient temperature depends on the model. (Refer to the specifications in this catalog.) Sudden thermal changes may cause thermal shock to distort the switch and result in faults.

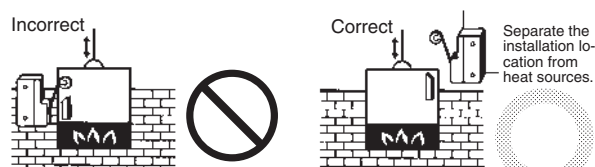

- Mount a cover if the switch is to be installed in a location where worker inattention could result in incorrect operation or accidents.



- Subjecting the switch to continuous vibration or shock may result in contact failure or faulty operation due to abrasion powder and in reduced durability. Excessive vibration or shock will cause the contacts to operate malfunction or become damaged. Mount the switch in a location that is not subject to vibration or shock and in a direction that does not subject the switch to resonance.
- If silver contacts are used with relatively low frequency for a long time or are used with microloads, the sulfide coating produced on the contact surface will not be broken down and contact faults will result. Use a microload switch that uses gold contacts.
- Do not use the switch in atmospheres with high humidity or heat or in harmful gases, such as sulfide gas (H<sub>2</sub>S, SO<sub>2</sub>), ammonia gas (NH<sub>3</sub>), nitric acid gas (HNO<sub>3</sub>), or chlorine gas (Cl<sub>2</sub>). Doing so may impair functionality, such as with damage due to contacting faults or corrosion.
- The switch includes contacts. If the switch is used in an atmosphere with silicon gas, arc energy may cause silicon oxide (SiO<sub>2</sub>) to accumulate on the contacts and result in contact failure. If there is silicon oil, silicon filling, silicon wiring, or other silicon products in the vicinity of the switch, use a contact protection circuit to limit arcing and remove the source of the silicon gas.

#### Panel-mounting model (A-20G□)

- If a Switch is side-mounted with screws, remove the hexagonal nut of the actuator.
- If a Switch is side-mounted and secured with screws, make sure that the angle or speed of the actuating object is not excessively large or too high, otherwise the Switch may be damaged.
- If a Switch is panel-mounted, pay utmost attention to make sure that the actuating speed or OT distance is not excessively high or large. Not doing so may damage the Switch.

## Accessories (Order Separately)

Refer to Z/A/X/DZ Common Accessories for details about Terminal Covers, Separators, and Actuators.

## Terms and Conditions Agreement

### Read and understand this catalog.

Please read and understand this catalog before purchasing the products. Please consult your OMRON representative if you have any questions or comments.

### Warranties.

(a) Exclusive Warranty. Omron's exclusive warranty is that the Products will be free from defects in materials and workmanship for a period of twelve months from the date of sale by Omron (or such other period expressed in writing by Omron). Omron disclaims all other warranties, express or implied.

(b) Limitations. OMRON MAKES NO WARRANTY OR REPRESENTATION, EXPRESS OR IMPLIED, ABOUT NON-INFRINGEMENT, MERCHANTABILITY OR FITNESS FOR A PARTICULAR PURPOSE OF THE PRODUCTS. BUYER ACKNOWLEDGES THAT IT ALONE HAS DETERMINED THAT THE PRODUCTS WILL SUITABLY MEET THE REQUIREMENTS OF THEIR INTENDED USE.

Omron further disclaims all warranties and responsibility of any type for claims or expenses based on infringement by the Products or otherwise of any intellectual property right. (c) Buyer Remedy. Omron's sole obligation hereunder shall be, at Omron's election, to (i) replace (in the form originally shipped with Buyer responsible for labor charges for removal or replacement thereof) the non-complying Product, (ii) repair the non-complying Product, or (iii) repay or credit Buyer an amount equal to the purchase price of the non-complying Product; provided that in no event shall Omron be responsible for warranty, repair, indemnity or any other claims or expenses regarding the Products unless Omron's analysis confirms that the Products were properly handled, stored, installed and maintained and not subject to contamination, abuse, misuse or inappropriate modification. Return of any Products by Buyer must be approved in writing by Omron before shipment. Omron Companies shall not be liable for the suitability or unsuitability or the results from the use of Products in combination with any electrical or electronic components, circuits, system assemblies or any other materials or substances or environments. Any advice, recommendations or information given orally or in writing, are not to be construed as an amendment or addition to the above warranty.

See <http://www.omron.com/global/> or contact your Omron representative for published information.

### Limitation on Liability; Etc.

OMRON COMPANIES SHALL NOT BE LIABLE FOR SPECIAL, INDIRECT, INCIDENTAL, OR CONSEQUENTIAL DAMAGES, LOSS OF PROFITS OR PRODUCTION OR COMMERCIAL LOSS IN ANY WAY CONNECTED WITH THE PRODUCTS, WHETHER SUCH CLAIM IS BASED IN CONTRACT, WARRANTY, NEGLIGENCE OR STRICT LIABILITY.

Further, in no event shall liability of Omron Companies exceed the individual price of the Product on which liability is asserted.

### Suitability of Use.

Omron Companies shall not be responsible for conformity with any standards, codes or regulations which apply to the combination of the Product in the Buyer's application or use of the Product. At Buyer's request, Omron will provide applicable third party certification documents identifying ratings and limitations of use which apply to the Product. This information by itself is not sufficient for a complete determination of the suitability of the Product in combination with the end product, machine, system, or other application or use. Buyer shall be solely responsible for determining appropriateness of the particular Product with respect to Buyer's application, product or system. Buyer shall take application responsibility in all cases.

NEVER USE THE PRODUCT FOR AN APPLICATION INVOLVING SERIOUS RISK TO LIFE OR PROPERTY OR IN LARGE QUANTITIES WITHOUT ENSURING THAT THE SYSTEM AS A WHOLE HAS BEEN DESIGNED TO ADDRESS THE RISKS, AND THAT THE OMRON PRODUCT(S) IS PROPERLY RATED AND INSTALLED FOR THE INTENDED USE WITHIN THE OVERALL EQUIPMENT OR SYSTEM.

### Programmable Products.

Omron Companies shall not be responsible for the user's programming of a programmable Product, or any consequence thereof.

### Performance Data.

Data presented in Omron Company websites, catalogs and other materials is provided as a guide for the user in determining suitability and does not constitute a warranty. It may represent the result of Omron's test conditions, and the user must correlate it to actual application requirements. Actual performance is subject to the Omron's Warranty and Limitations of Liability.

### Change in Specifications.

Product specifications and accessories may be changed at any time based on improvements and other reasons. It is our practice to change part numbers when published ratings or features are changed, or when significant construction changes are made. However, some specifications of the Product may be changed without any notice. When in doubt, special part numbers may be assigned to fix or establish key specifications for your application. Please consult with your Omron's representative at any time to confirm actual specifications of purchased Product.

### Errors and Omissions.

Information presented by Omron Companies has been checked and is believed to be accurate; however, no responsibility is assumed for clerical, typographical or proofreading errors or omissions.

2015.9

In the interest of product improvement, specifications are subject to change without notice.

**OMRON Corporation**  
Industrial Automation Company

<http://www.ia.omron.com/>

(c)Copyright OMRON Corporation 2015 All Right Reserved.