

## Ratiometric Linear Hall-Effect IC, Analog Output

### 1 Product Description

The MT910X device is a linear Hall effect IC that responds proportionally to magnetic flux density. The device can be used for accurate position sensing in a wide range of applications.

The device operates from 3.0V to 5.5V power supplies. When no magnetic field is present, the analog output drives ½ of Vcc. The output changes linearly with the applied magnetic flux density, and four sensitivity options enable maximal output voltage swing based on the required sensing range. North and south magnetic poles produce unique voltages.

The MT910X family provides a variety of packages to customers. SOT-23 (Thin Outline) & DFN1616 for surface mount and flat TO-92 for through-hole mount. All packages are RoHS compliant.

### 2 Features

- BCD Technology
- Factory-programmed
- Ratiometric Rail to Rail Analog Output
- Low-Noise Output
- 3.0~5.5V Operating Vcc Range
- -40°C~150°C Operating Temperature
- Package Option:
  - Flat TO-92/SOT-23 (Thin Outline)/DFN1616
- Magnetic Sensitivity Option:
  - 1.50mV/Gs MT9101 Series @Vcc = 5V
  - 2.50mV/Gs MT9102 Series @Vcc = 5V
  - 3.40mV/Gs MT9103 Series @Vcc = 5V
  - 5.00mV/Gs MT9105 Series @Vcc = 5V
  - 1.00mV/Gs MT9101 Series @Vcc = 3.3V
  - 1.60mV/Gs MT9102 Series @Vcc = 3.3V
  - 2.15mV/Gs MT9103 Series @Vcc = 3.3V
  - 3.15mV/Gs MT9105 Series @Vcc = 3.3V
- RoHS Compliant: (EU)2015/863

### 3 Product Overview of MT910X

Part No.	Description
MT910XA	Flat TO-92, bulk packaging (1000pcs/bag)
MT910XET	SOT-23 (Thin Outline), tape & reel (3000pcs/bag)
MT910XDT-1616	DFN1616, tape & reel (3000pcs/bag)

- MT910XDT-1616 only for 3.0~3.6V application

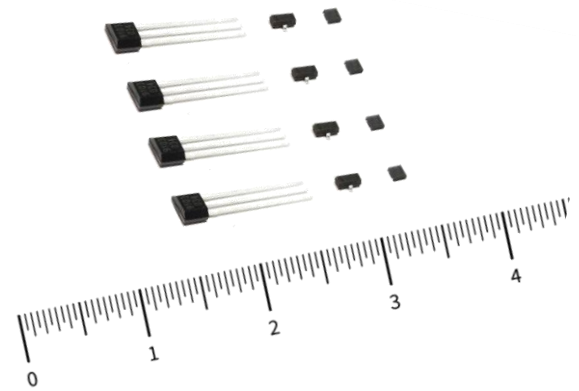

### 4 Applications

- Home appliances
- Industrial
- Speed Detection
- Position Detection
- Magnetic Encoder
- Ferrous Metal Sensing
- Vibration Sensing
- Weight Sensing

### 5. Pin Configuration and Functions

	Vcc	Out	GND
SOT-23 (Thin Outline)	1	2	3
Flat TO-92	1	3	2
DFN1616	4	2	5
Description	Power	Output	Ground

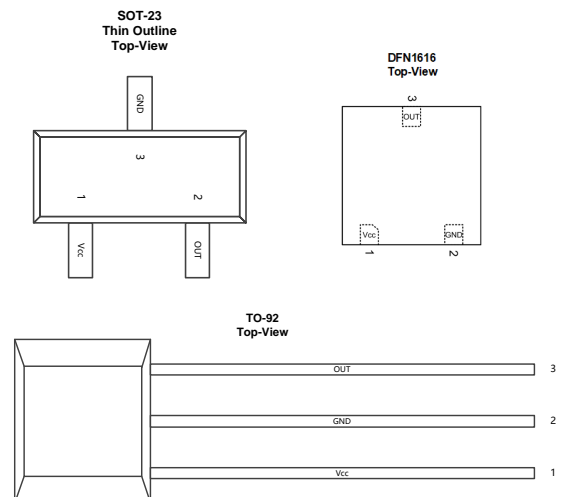

Figure.1 Pin Configuration & Functions

## Table of Contents

1	Product Description.....	1
2	Features.....	1
3	Product Overview of MT910X .....	1
4	Applications.....	1
5	Pin Configuration and Functions.....	1
6	Transfer Characteristics.....	3
7	Function Description.....	3
8	Feature Description.....	3
9	Functional Block Diagram.....	4
10	Electrical and Magnetic Characteristics.....	4
	10.1 Absolute Maximum Ratings.....	4
	10.2 ESD Ratings.....	4
	10.3 Electrical Specifications.....	5
	10.4 Magnetic Characteristics.....	5
	10.5 Characteristic Performance.....	6
11	Typical Application Circuit.....	8
12	Package Material Information.....	9
	12.1 SOT-23 (Thin Outline) Package Information.....	9
	12.2 Flat TO-92 Package Information.....	10
	12.3 DFN1616 Package Information.....	11
13	Copy Rights and Disclaimer.....	12

## Reversion History

1	Originally Version	
2	Version 1.1	Update characteristic performance & Noise
3	Version 1.2	Update parameters @ 3.3V Vcc
4	Version 1.3	Update the marking spec of SOT-23 (Thin Outline)
5	Version 1.4	Update the drawing information of flat TO-92
6	Version 1.5	Add MT910XDT-1616
7	Version 1.6	Update Transfer Characteristics

## 6 Transfer Characteristics

Figure.2 shows four sensitivity options enable maximal output voltage swing based on the required sensing range

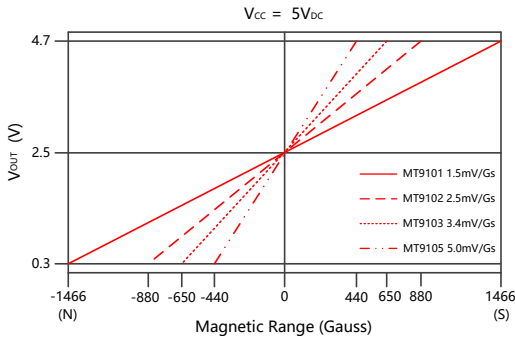

Figure.2 Transfer Characteristics ( $V_{CC}=5V$ )

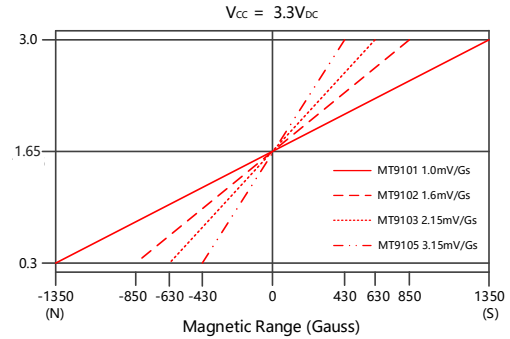

Figure.3 Transfer Characteristics ( $V_{CC}=3.3V$ )

## 7 Function Description

The device produces a linear response when the output voltage is within the specified voltage range. Outside this range, sensitivity is reduced and nonlinear

## 8 Feature Description

The MT910X device is sensitive to the magnetic field component that is perpendicular to the top of the package

When the magnetic field moving from the left side of the IC to the middle which showed in the left of the Figure.3, the  $V_{OUT}$  changing from 0.3 to 2.5V linearity when  $V_{CC}=5V$

When the magnetic field located at the middle of the IC which showed in the middle of the Figure.3, the  $V_{OUT}$  is 2.5V (1/2 of the  $V_{CC}=5V$ )

When the magnetic field moving from the middle side of the IC to the right which showed in the right of the Figure.3, the  $V_{OUT}$  changing from 2.5 to 4.7V linearity when  $V_{CC}=5V$

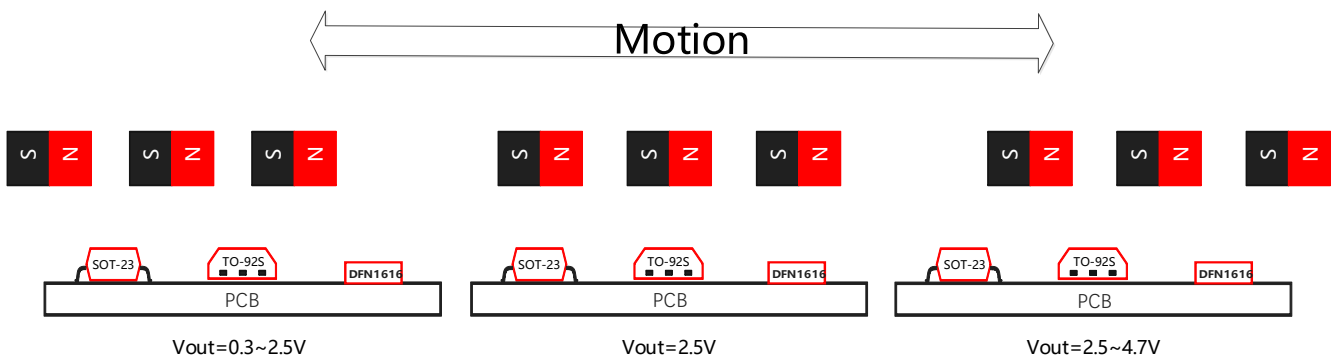

Figure.4 Feature Description

## 9 Functional Block Diagram

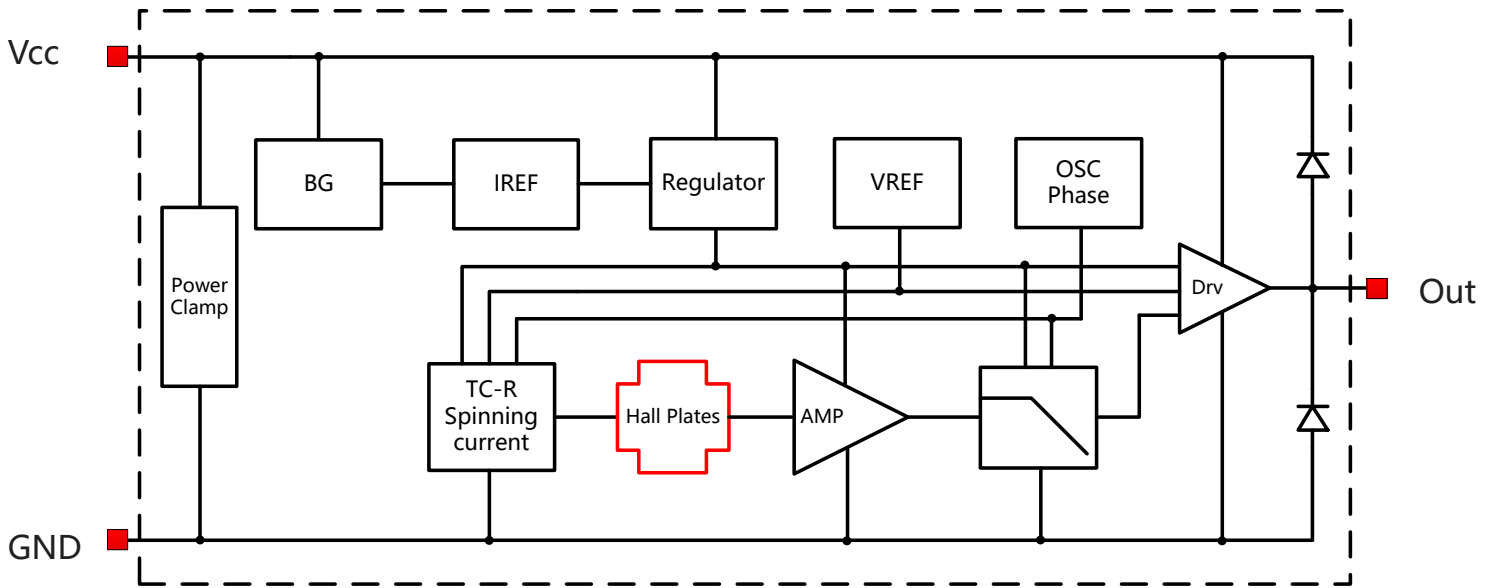

Figure.5 Functional Block Diagram

## 10 Electrical and Magnetic Characteristics

### 10.1 Absolute Maximum Ratings

Absolute maximum ratings are limited values to be applied individually, and beyond which the serviceability of the circuit may be impaired. Functional operability is not necessarily implied. Exposure to absolute maximum rating conditions for an extended period of time may affect device reliability.

Symbol	Parameters	Min	Max	Units
VCC	Supply Voltage	-	30	V
VRCC	Reverse Battery Voltage	-0.2	-	V
VOUT	Output Voltage	-	30	V
IOUT	Continuous Output Current	-5	5	mA
TA	Operating Ambient Temperature	-40	150	°C
TS	Storage Temperature	-40	160	°C
TJ	Junction Temperature	-	165	°C

### 10.2 ESD Ratings

Symbol	Reference	Values	Unit
VESD	Human-body model (HBM)	AEC-Q100-002	±3000 V
	Charged-device model (CDM)	AEC-Q100-011	±1000 V

### 10.3 Electrical Specifications

At  $T_A = -40 \sim 150 \text{ }^\circ\text{C}$ ,  $V_{CC} = 3.0\text{V} \sim 5.5\text{V}$  (unless otherwise specified)

Symbol	Parameters	Test Condition	Min	Typ	Max	Unit
$V_{CC}$	Supply Voltage		3.0	-	5.5	V
$I_{CC}$	Supply Current	$V_{CC} = 5\text{V}; B = 0$	-	6.7	8.6	mA
		$V_{CC} = 3.3\text{V}; B = 0$	-	6.0	7.0	mA
$T_{PO}$	Power on Time	$dV_{CC}/dt \geq 5\text{V}/\mu\text{s}$	-	-	30	$\mu\text{s}$
$I_{SINK}$	Sink Current	$B = 0; V_{OUT} = V_{CC}$	-1.5	-	-	mA
$I_{SOURCE}$	Source Current	$B = 0; V_{OUT} = 0$	-	-	1.5	mA
BW	Bandwidth		20	30	-	KHz
$F_C$	Chopper Frequency		-	780	-	KHz
$N_F$	Noise	$B = 0; T_A = 25^\circ\text{C}$	-	1.9	2.6	mG/root(Hz)
		MT9101; $T_A = 25^\circ\text{C}$	-	1.46	-	mVRMS
		MT9102; $T_A = 25^\circ\text{C}$	-	2.44	-	mVRMS
		MT9103; $T_A = 25^\circ\text{C}$	-	3.32	-	mVRMS
		MT9105; $T_A = 25^\circ\text{C}$	-	4.88	-	mVRMS
$R_{OUT}$	Output Resistance	$I_{OUT} \leq \pm 1.5\text{mA}$ $V_{OUT} = 2.5\text{V}$	-	2	4	Ohm
$R_L$	Output Loading Resistance	$I_{OUT} \leq 1.5\text{mA}$ Output to GND or to $V_{CC}$	4.7	-	-	Kohm
$C_L$	Output Loading Capacitance	$I_{OUT} \leq \pm 1.5\text{mA}$ Output to GND	-	-	10	nF
$R_{TH}$	Thermal Resistance of SOT-23 (Thin outline)		-	301	-	$^\circ\text{C}/\text{W}$
	Thermal Resistance of Flat TO-92		-	230	-	$^\circ\text{C}/\text{W}$
	Thermal Resistance of DFN1616		-	301	-	$^\circ\text{C}/\text{W}$

### 10.4 Magnetic Characteristics

At  $T_A = -40 \sim 150 \text{ }^\circ\text{C}$ ,  $V_{CC} = 3.0\text{V} \sim 5.5\text{V}$  (unless otherwise specified)

Symbol	Parameters	Test Condition	Min	Typ	Max	Unit
LIN	Linearity		-1.5	-	1.5	%
$V_{NULL}$	Quiescent Voltage	$V_{CC} = 5\text{V}; B = 0$ $T_A = 25^\circ\text{C}$	2.475	2.500	2.525	V
		$V_{CC} = 3.3\text{V}; B = 0$ $T_A = 25^\circ\text{C}$	1.630	1.650	1.670	V
$V_{NULL} (V)$	Ratiometry, $V_{NULL}$	$V_{CC} = 4.5\text{V} \sim 5.5\text{V}$	-1.5	-	1.5	%
$V_{NULL} (T)$	$V_{NULL}$ Variation Over Temperature	$V_{CC} = 4.5\text{V} \sim 5.5\text{V}$	-1.5	-	1.5	%
$S_{SENS} (T)$	$S_{SENS}$ Variation Over Temperature		-10	-	10	%

### 10.4 Magnetic Characteristics (continued)

At  $T_A = -40 \sim 150 \text{ }^\circ\text{C}$ ,  $V_{CC} = 3.0\text{V} \sim 5.5\text{V}$  (unless otherwise specified)

Symbol	Parameters	Test Condition	Min	Typ	Max	Unit
SENS	Sensitivity $T_A = 25^\circ\text{C}; V_{CC} = 5\text{V}$	MT9101	1.395	1.500	1.605	mV/Gs
		MT9102	2.325	2.500	2.675	mV/Gs
		MT9103	3.162	3.400	3.638	mV/Gs
		MT9105	4.650	5.000	5.350	mV/Gs
	Sensitivity $T_A = 25^\circ\text{C}; V_{CC} = 3.3\text{V}$	MT9101	0.900	1.000	1.100	mV/Gs
		MT9102	1.488	1.600	1.712	mV/Gs
		MT9103	2.000	2.150	2.300	mV/Gs
		MT9105	2.930	3.150	3.370	mV/Gs
B	Magnetic Field Range $T_A = 25^\circ\text{C}; V_{CC} = 5\text{V}$	MT9101	-	$\pm 1466$	-	Gs
		MT9102	-	$\pm 880$	-	Gs
		MT9103	-	$\pm 650$	-	Gs
		MT9105	-	$\pm 440$	-	Gs
	Magnetic Field Range $T_A = 25^\circ\text{C}; V_{CC} = 3.3\text{V}$	MT9101	-	$\pm 1350$	-	Gs
		MT9102	-	$\pm 850$	-	Gs
		MT9103	-	$\pm 630$	-	Gs
		MT9105	-	$\pm 430$	-	Gs

### 10.5 Characteristic Performance

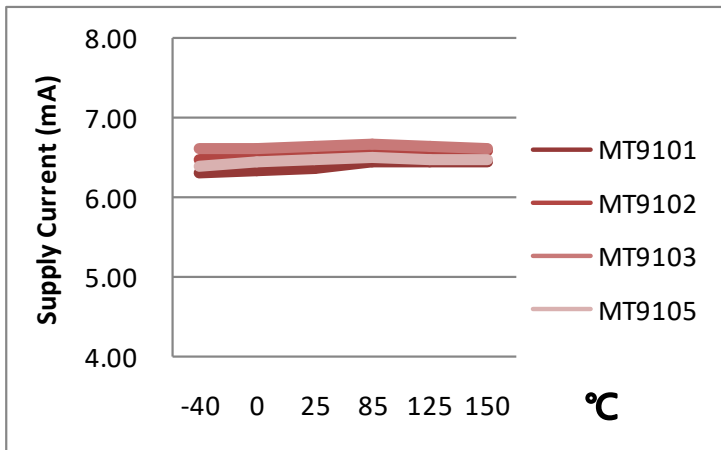

Figure.6 Supply Current vs. Temperature (At  $V_{CC} = 5.0\text{V}$ )

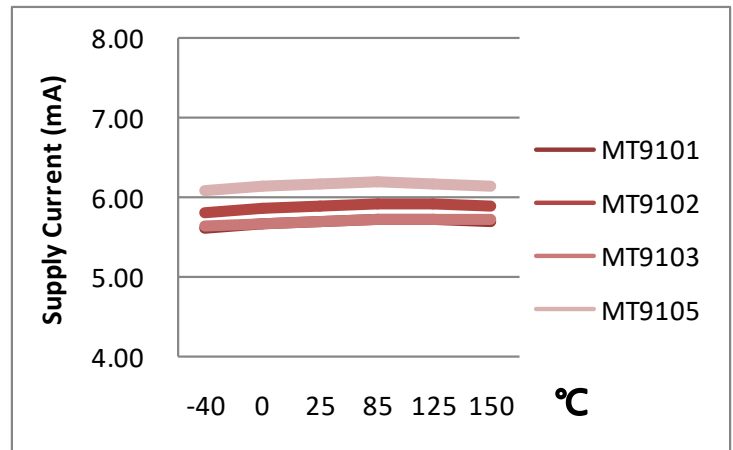

Figure.7 Supply Current vs. Temperature (At  $V_{CC} = 3.3\text{V}$ )

### 10.5 Characteristic Performance (continued)

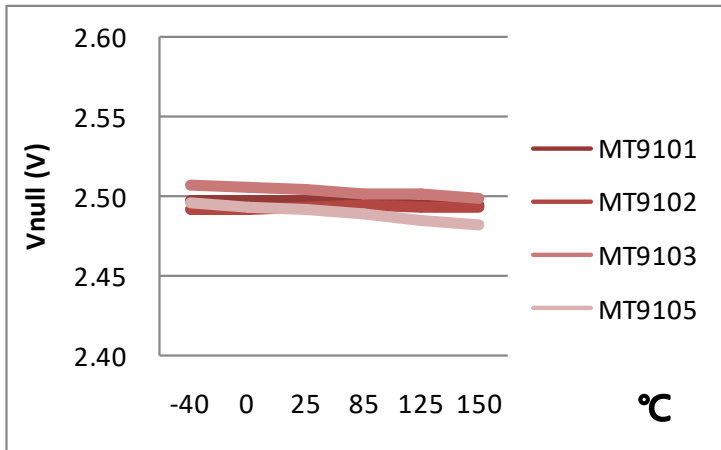

Figure.8 Vnull vs. Temperature (At Vcc=5.0V)

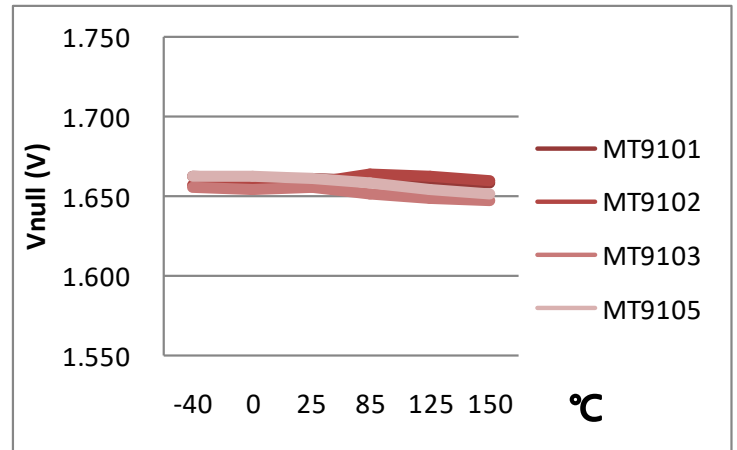

Figure.9 Vnull vs. Temperature (At Vcc=3.3V)

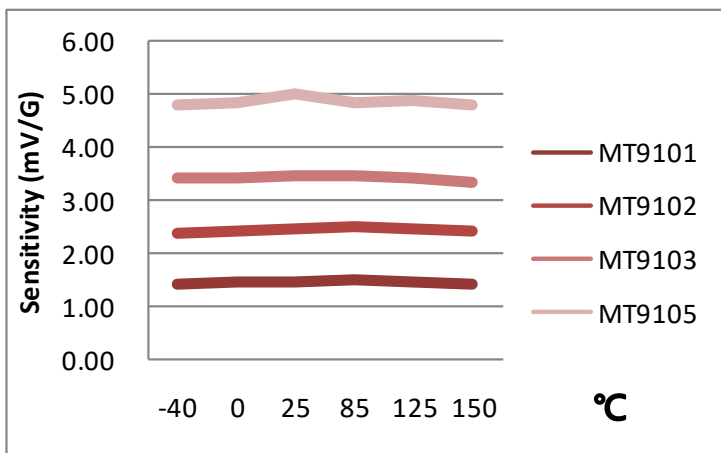

Figure.10 Sensitivity vs. Temperature (At Vcc=5.0V)

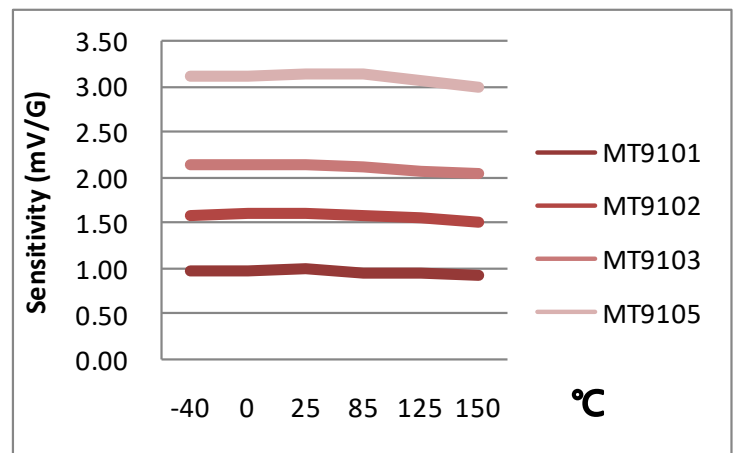

Figure.11 Sensitivity vs. Temperature (At Vcc=3.3V)

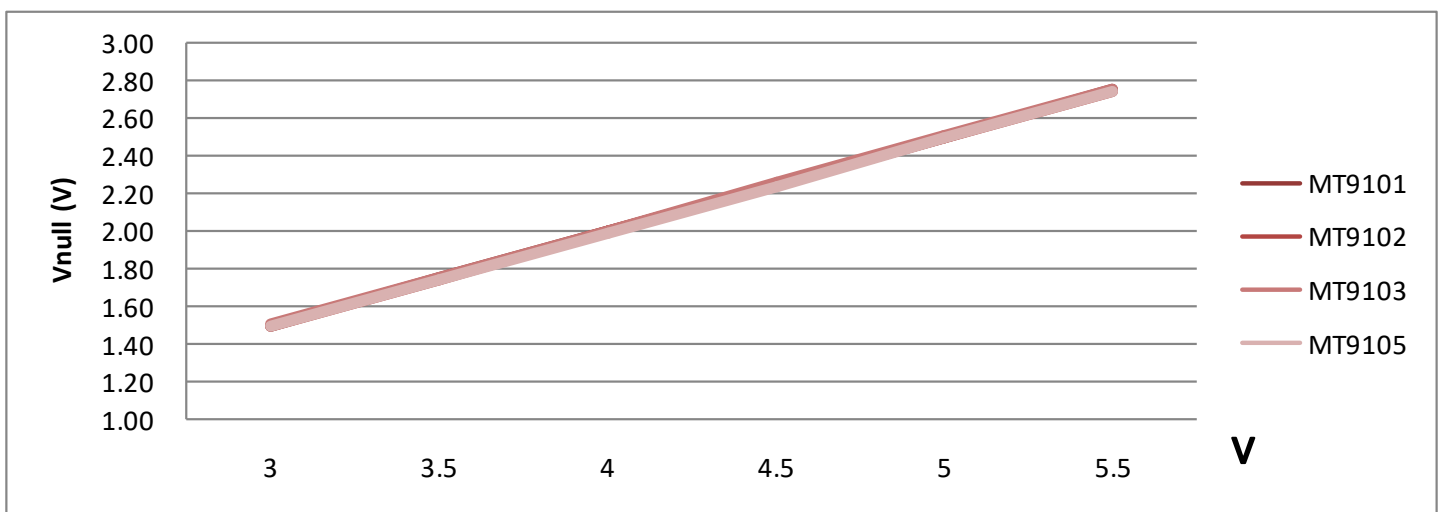

Figure.12 VNULL vs. Vcc (At B=0Gs; TA=25°C)

### 10.5 Characteristic Performance (continued)

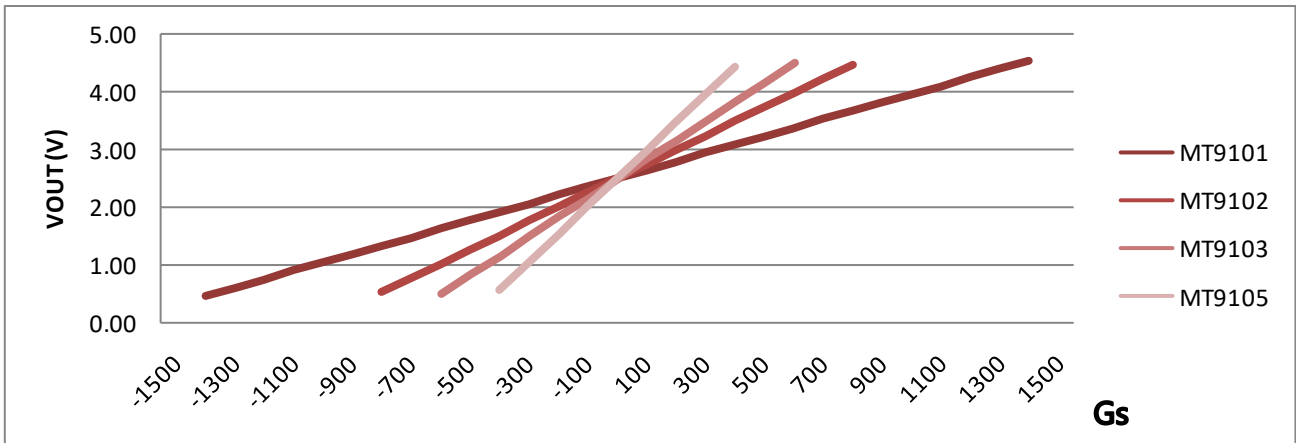

Figure.13 V<sub>OUT</sub> vs. Magnetic Field (At V<sub>CC</sub>=5.0V; T<sub>A</sub>=25°C)

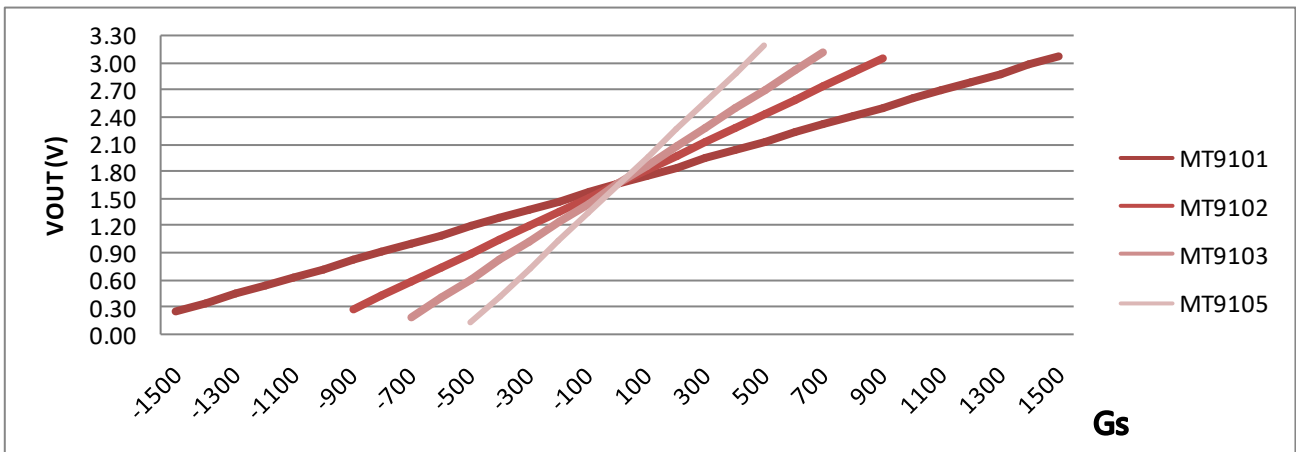

Figure.14 V<sub>OUT</sub> vs. Magnetic Field (At V<sub>CC</sub>=3.3V; T<sub>A</sub>=25°C)

### 11 Typical Application Circuit

MT9101ET as example

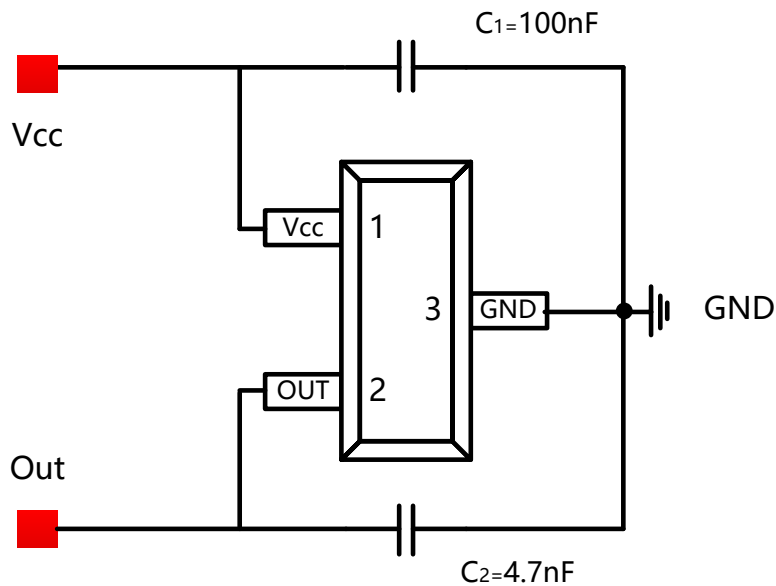

Figure.15 Typical Application Circuit



12 Package Material Information (For Reference Only – Not for Tooling Use)

12.1 SOT-23 (Thin Outline) Package Information

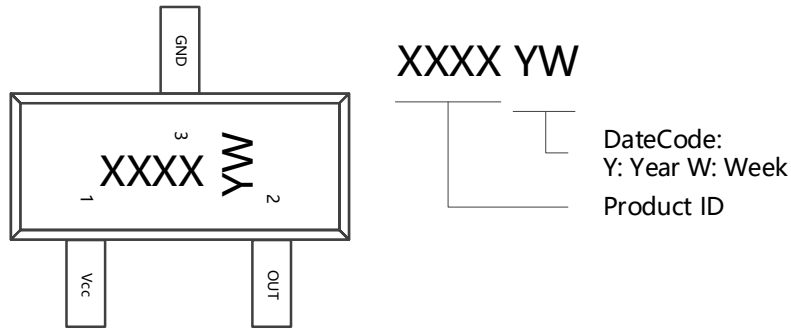

Figure.16 SOT-23 (Thin Outline) Chip Marking Spec

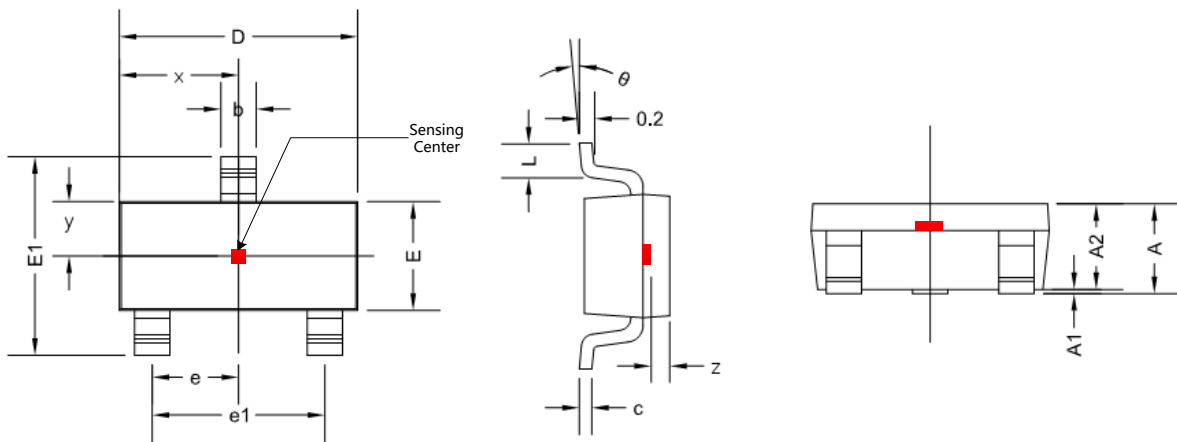

Figure.17 SOT-23 (Thin Outline) Package Drawing

Symbol	Dimensions in Millimeters		Dimensions in Inches	
	Min	Max	Min	Max
A	0.900	1.150	0.035	0.045
A1	0.000	0.100	0.000	0.004
A2	0.900	1.050	0.035	0.041
b	0.300	0.500	0.012	0.020
c	0.080	0.150	0.003	0.006
D	2.800	3.000	0.110	0.118
E	1.200	1.400	0.047	0.055
E1	2.250	2.550	0.089	0.100
e	0.950 TYP		0.037 TYP	
e1	1.800	2.000	0.071	0.079
L	0.550 REF		0.022 REF	
L1	0.300	0.500	0.012	0.020
θ	0 °	8 °	0 °	8 °
x	1.460 TYP		0.057 TYP	
y	0.650 TYP		0.026 TYP	
z	0.500 TYP		0.020 TYP	

## 12.2 Flat TO-92 Package Information

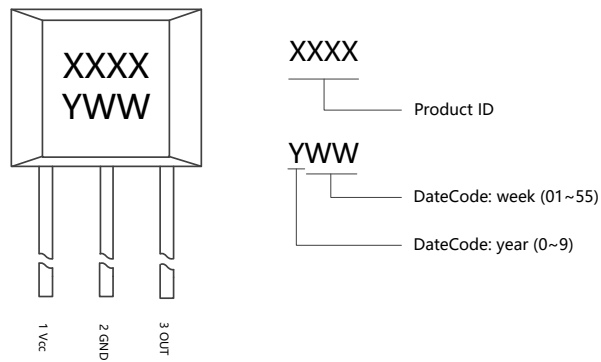

Figure.18 Flat TO-92 Chip Marking Spec

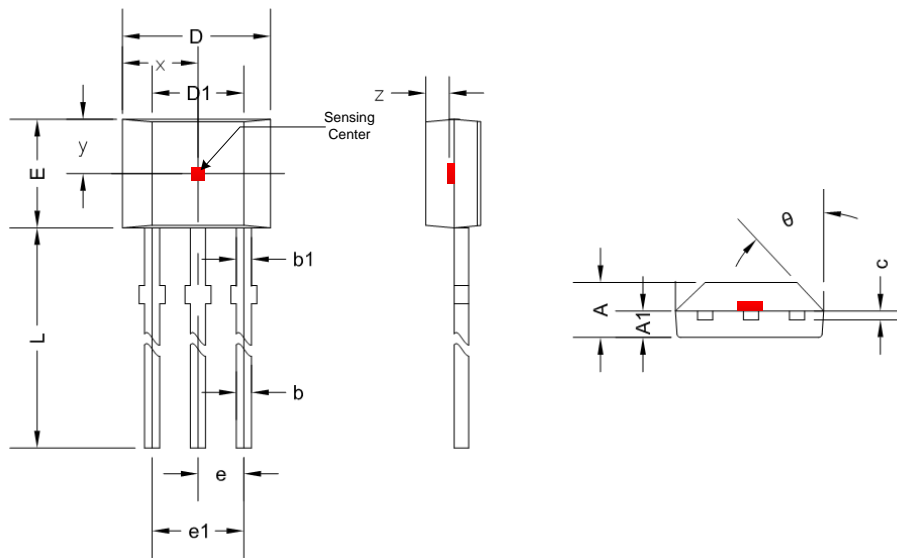

Figure.19 Flat TO-92 Package Drawing

Symbol	Dimensions in Millimeters		Dimensions in Inches	
	Min	Max	Min	Max
A	1.420	1.620	0.056	0.064
A1	0.660	0.860	0.026	0.034
b	0.330	0.430	0.013	0.017
b1	0.330	0.430	0.013	0.017
c	0.330	0.510	0.013	0.020
D	3.900	4.100	0.154	0.161
D1	2.280	2.680	0.090	0.106
E	3.050	3.250	0.120	0.128
e	1.270 TYP		0.050 TYP	
e1	2.440	2.640	0.096	0.104
L	14.350	14.750	0.564	0.580
$\theta$	45 ° TYP		45 ° TYP	
x	2.025 TYP		0.080 TYP	
y	1.545 TYP		0.061 TYP	
z	0.500 TYP		0.020 TYP	

### 12.3 DFN1616 Package Information

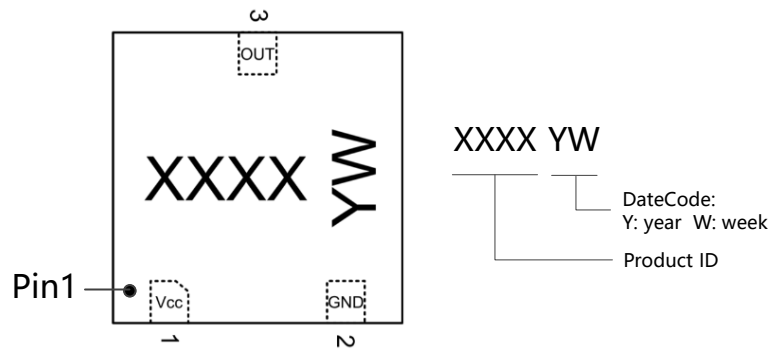

Figure.20 DFN1616 Chip Marking Spec

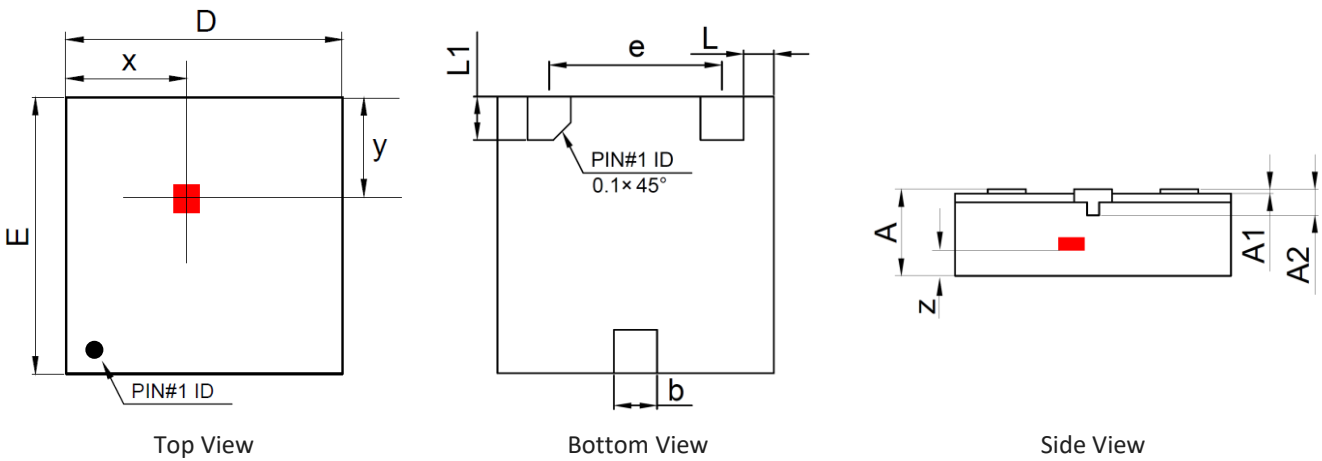

Figure.21 DFN1616 Package Drawing

Symbol	Dimensions in Millimeters		Dimensions in Inches	
	Min	Max	Min	Max
A	0.450	0.550	0.018	0.022
A1	0.000	0.050	0.000	0.002
A2	0.150 TYP		0.006 TYP	
L	0.175 TYP		0.007 TYP	
L1	0.200	0.300	0.008	0.012
D	1.550	1.650	0.061	0.065
E	1.550	1.650	0.061	0.065
b	0.200	0.300	0.008	0.012
e	0.950	1.050	0.037	0.041
x	0.716		0.028	
y	0.660		0.026	
z	0.185		0.007	

### 13 Copy Rights and Disclaimer

1. This document may not be reproduced or duplicated, in any form, in whole or in part without prior written consent of MagnTek . Copyrights © 2019, MagnTek Incorporated.
2. MagnTek reserves the right to make changes to the information published in this document at anytime without notice.
3. MagnTek' s products are limited for use in normal commercial applications. MagnTek' s products are not to be used in any device or system, including but not limited to medical life support equipment and system.

For the latest version of this document, please visit our website: [www.magntek.com.cn](http://www.magntek.com.cn)