

\*\* Not all features are shown in this drawing. For more detailed information, please contact your Fair-Rite representative.

UNCONTROLLED ~CATALOG~ DRAWING

SIZE	PART NO.	REV.
B	2961666671	~

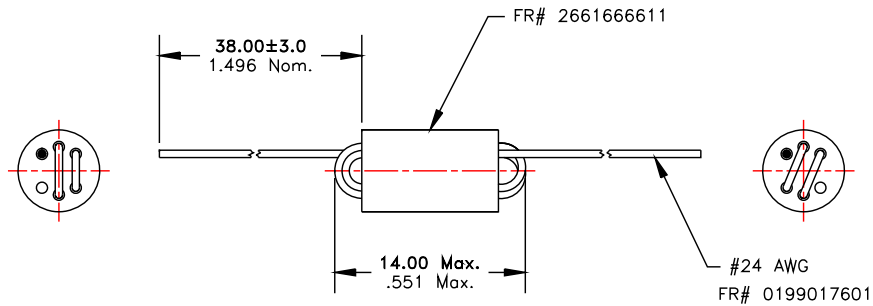

DIMENSIONS  
**BOLD NUMBERS ARE IN MILLIMETERS**  
 LIGHT NUMBERS ARE IN INCHES

ELECTRICAL SPECIFICATIONS

IMPEDANCE (Ohms)		
50 MHz	100 MHz	200 MHz
448 Min.	624 Min.	768 Min.

NOTES:

- 1 - CHIPS CRACKS, AND APPEARANCE TO MEET FAIR-RITE VISUAL INSPECTION CRITERIA FOR GENERIC MULTI-HOLE WOUND BEADS.
- 2 - IMPEDANCE MEASURED USING A HP4191A ON A 16092A TEST FIXTURE, WITH FIXTURE COMPENSATION, AND A WIRE LENGTH CUT TO <6.35mm [<.250"].
- 3 - WIRE MEETS SOLDERABILITY SPECIFICATION WHEN TESTED PER FAIR-RITE PRODUCTS CORP. SOP# ELC-57.
- 4 - PART MEETS FAIR-RITE PRODUCTS CORP. SOP# ELC-55, FOR THERMAL SHOCK RESISTANCE.
- 5 - RESISTIVITY > 1 X 10E6 Ohms-cm, Rdc @ 10Vdc, ACROSS "C" DIMENSION > 4 X 10E6 Ohms.
- 6 - WIRE LOOPS SHOULD BE UNIFORM IN LENGTH.
- 7 - PART IS TO BE BULK PACKED

<b>FAIR-RITE PRODUCTS CORP.</b>				
TITLE				
WOUND BEAD				
DRAWN BY	DATE	SIZE	PART NO.	REV.
D. FOOTE	11/13/2019	B	2961666671	~
CHKD BY				
APPRVD BY		SCALE: NONE	SHEET 1 OF 1	

FR# 61