

SBE®160 / SBX®175 Connectors - up to 175 Amps

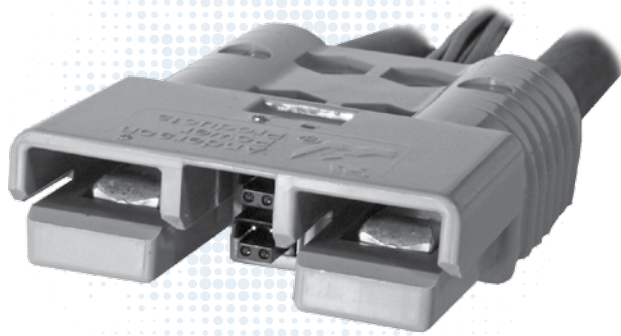

SBX® and SBE® connectors can integrate up to 8 auxiliary power / signal contacts along with the two primary power circuits. SBE® connectors feature an IEC 60950 touch safe housing molded from a chemical resistant PBT/PC blend resin. SBX® are molded from a rugged PC resin and are rated IP20 per IEC 60529.

- Touch Safe Interface**
Minimizes potential contact with live circuits per IEC 60950 & IEC 60529
- Up to 8 Last Mate / First Break Auxiliaries**
Enables intelligent power switching, CAN and interlock loop circuitry, as well as power up to 20 amps per pole
- Color-coded Mechanical Voltage Keys**
Like all Multipole connectors, the SBE® and SBX® offer an easy way to identify circuits and protect against cross mating

| SBE®160 / SBX®175 ORDERING INFORMATION |

SBE®160 / SBX®175 Housings

The middle size of SBE®, X, O style housing. SBE® housings are molded from a chemical resistant PBT. SBX® housings are molded from PC. SBE®160 and SBX®175 housings of the same Voltage Color Code can be mated (except yellow) but is not recommended as it invalidates UL approvals. SBX®175 housings do not meet EN1175-1 requirements for industrial trucks.

Description	- SBE®160 Part Numbers -		- SBX®175 Part Numbers -		
	Minimum Quantity	100	25	100	25
Yellow	2-8170G4	E6383G1	2-7251G4	6383G1	
Orange	2-8170G3	E6382G1	2-7251G3	6382G1	
Red	2-8170G5	E6385G1	2-7251G5	6385G1	
Gray	2-8170G1	E6380G1	2-7251G1	6380G1	
Blue	2-8170G2	E6381G1	2-7251G2	6381G1	
Green	2-8170G7	E6390G1	2-7251G7	6390G1	
Black	2-8170G14	E6392G1	N/A	N/A	

* Yellow SBE®160 and SBX®175 housings are NOT intermateable.

SBE®160 / SBX®175 Silver Plated Primary Power Wire Contacts

Use two silver plated contacts per housing for the best electrical performance and durability up to 10,000 mating cycles. See reducing bushings in accessory section for smaller wires.

AWG	mm ²	- Loose Piece Part Numbers -		Dimensions - A -	
		Minimum Quantity..	500	50	inches
1/0	50	6384G1-BK	6384G1 *	0.44	11.1
2	35	6384G2-BK	6384G2 *	0.38	9.7

* Sold as pairs. 2 parts shipped for every 1 part ordered.

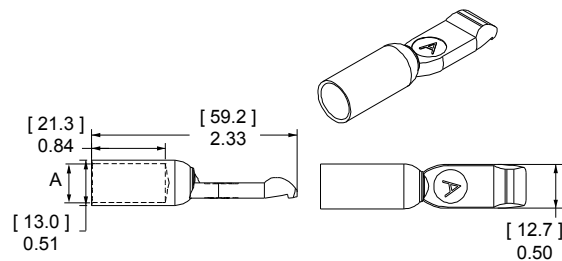
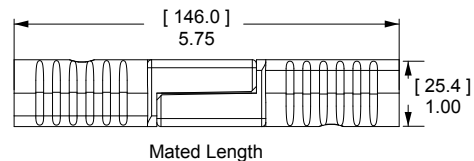
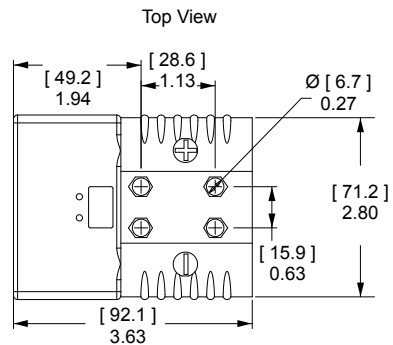

SBE®160 / SBX®175 CONNECTOR SPECIFICATIONS |

Electrical		
Current Rating Amperes ¹	SBX175	SBE160
Primary Power (1/0 AWG)	175	160
Powerpole® Auxiliary (12 AWG)	20	20
1x4 Auxiliary (12 AWG)	20	20
PPMX Auxiliary (20 AWG)	7 UL	5 CSA
Voltage Rating AC/DC	UL 1977	EN1175-1
Primary Power	600	150 ⁴
Powerpole® Auxiliary	600	150 ⁴
1x4 Auxiliary	200	
PPMX Auxiliary	300	
Dielectric Withstanding Voltage Primary Power		
Volts AC	2,200	
Avg. Mated Contact Resistance Milliohms ¹		
6" of 1/0 AWG wire	0.100	
UL Hot Plug Current Rating Amperes - 250 cycles at 120V DC		
Power	75A	
Powerpole® Auxiliary	30A	
1x4 Auxiliary	5A	

Materials	
Housing	
SBX® and Powerpole® Plastic Resin	Polycarbonate
SBE® and 1x4 Auxiliary Housing	Polycarbonate / PBT blend
Contact Retention Spring	Stainless Steel
Housing Flammability Rating	
UL94	V-0
Glow Wire - SBE160 Only	960°C (GWFI) / 850°C (GWIT)
Power & Powerpole® Contact	Silver Plated Copper Alloy
1x4 Auxiliary Contacts	
Pin	Copper alloy, Au over Ni
Socket	BeCu, Au over Ni
Socket Body	Copper alloy, Sn bright over Ni
Retention Clip	Stainless Steel
PPMX Contacts	Gold Plated Copper Alloy
Contact Termination Methods	
Crimp ³	
Hand Solder	

Mechanical		
Wire Size Range	AWG	mm²
Power Contacts	10 to 1/0	5.3 to 53.5
Auxiliary Contacts	24 to 10	0.25 to 5.3
Max. Wire Insulation Diameter	in.	mm
Power Contacts	0.600	15.200
Powerpole® Auxiliary	0.175	4.450
1x4 Auxiliary	0.140	3.600
Operating Temperature ²	°F	°C
SBX® and SBE® Housings	-4° to 221°	-20° to 105°
Mating Cycles No Load by Plating	Silver (Ag)	Gold (Au)
Power Contacts	10,000	
Powerpole® Auxiliary	10,000	
1x4 Auxiliary		10,000
PPMX Auxiliary		5,000
Avg. Mating / Unmating Force	Lbf.	N
Main Connector Housing	30	134
Per Powerpole® Connector	5.00	22.00
Per Contact in 1x4 Auxiliary	0.70	3.00
Per PPMX Housing	4.50	20.00
Min. Contact / Spring Retention Force	Lbf.	N
Power Standard Housing	120	533.7
Powerpole® Housing	25	111
1x4 Auxiliary Housing	10	44.5
PPMX Housing	12	53

NOTE 1: See IEC 60664-1 for working voltage.

NOTE 2: Amp ratings are stated per position and based on all positions being fully loaded.

¹ Based on: 105°C rated or better cable of the largest size, Properly calibrated APP recommended tooling, and a 25°C ambient temperature. UL rating not to exceed the maximum operating temperature. CSA rating below a 30°C temperature rise.

² Limited by the thermal properties of the connector plastic housing.

³ Use APP recommended tooling only. Alternate tools may adversely affect the performance of our connectors along with UL and CSA recognition.

⁴ Voltage capability of SBE® housing is identical to SBX®, but derated to meet EN1175-1 requirements.



IEC INFORMATION |

Connector Series	Configurations	Creepage/Clearance per IEC 60950-1	Material Group
SBE®160	Unmated	6.1 mm	IIla
	Mated	11.6 mm	

Attributes	SBE160
AMP Rating AC/DC	160 Amp
Voltage Rating AC/DC (Steady State)	600 V AC/DC (Operational)
Breaking Capacity -AMP Rating /Cycles	160 Amp / 10 Cycles
Voltage Rating (Breaking Capacity)	220 VDC
FINGER Safety - Mated/Unmated	IEC 60529 - IP20
Wire Size tested	50 mm ²
Contact Series Tested	6384G1
Climatic Testing (Cold,Heat & MFG)	IEC 60512 Test -11j, 11i & 11g,
Cycle Life	IEC 60512 Test 9a - 5000 Cycles
Mechanical Strength Impact	IEC 60512-5 @ 29.5 Inches - dropped 8 times
Temperature Range	-20 °C to 105 °C -4 °F to 221 °F

Protection	
Touch Safety Main Connector Housing	
IEC 60950 SBE®160 Only	Pass
IEC 60529 SBX®175 Only	IP20

NOTE 3: Refer to the Constructional Data form for additional information on our website., www.andersonpower.com



| SBE®160 / SBX®175 CONNECTOR TEMPERATURE CHARTS|

Temperature rise charts are based on a 25°C ambient temperature.

For Temperature Rise Above 60°C, Consult the Extended Temperature Rise Charts in the Appropriate Product Section on the Website.

Current - Temperature Derating per IEC 60512-5-2 Test 5B

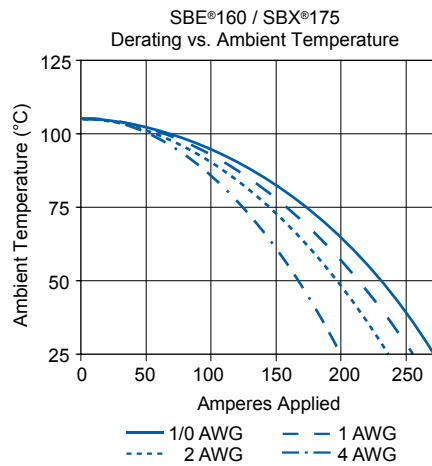
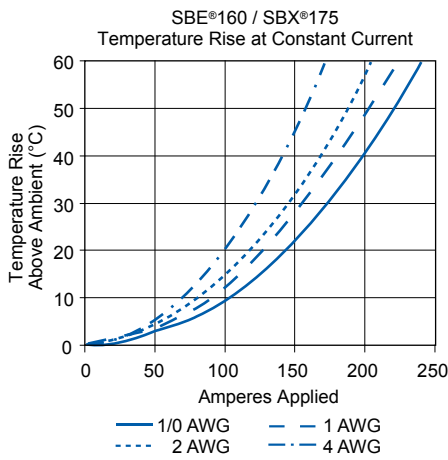

| SBE®160 / SBX®175 ACCESSORIES |

Cable Clamps

Durable metal clamps adapt to a wide range of cable sizes.

Description	Cable Size		- Part Number -
	Min / Max Inches O.D.	Min / Max mm O.D.	
Minimum Quantity			25
Cable Clamp Kit	0.62 to 0.22	15.7 to 5.6	945G2

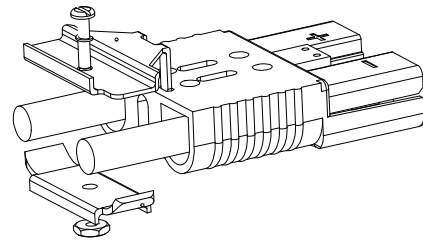

The given wire O.D. information is an estimate. Cable clamps should be evaluated for performance with the actual wire to be used.

Handles

Handles are made out of durable PC plastic. Hardware to attach to connector body included in kits.

Description	----- Part Numbers -----	
Minimum Quantity...	100	25 ..
Gray Handle Kit	995G1-APP	995G1
Red Handle Kit	995G3-APP	995G3
Handle Only, Gray	3-5074P1	-
Handle Only, Red	3-5074P3	-
Handle Only, Black	3-5074P5	-
Hardware Bag	-	105G8

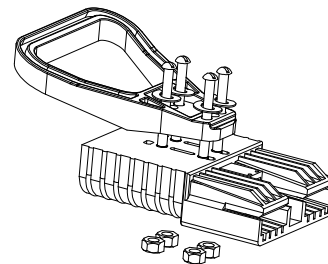

Powerpole® Auxiliary

Powerpole® auxiliary connectors are rated up to 30 amps 600 volts and can be used for auxiliary power, control or sensing. The auxiliary kit includes (1) each black and red Standard Powerpole® housing, (2) contacts, (2) zip cable straps, and (2) retaining pins. (1) Retaining clip can be substituted for (2) retaining pins.

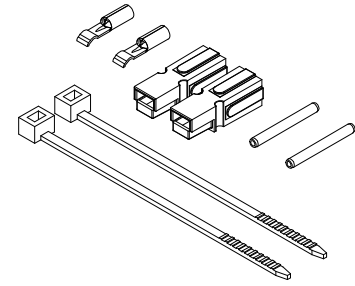

Description	--- Part Numbers ---	
Minimum Quantity	200	25 ...
Powerpole® Auxiliary Kit	-	6344
Black Powerpole® Housing	1327G6	-
Red Powerpole® Housing	1327	-
#16 to #12 Contact	1331	-

1x4 Auxiliary Connector

The unique 1x4 auxiliary connector allows up to 4 auxiliary circuits up to 20 amps 150 volts each in SBE®, SBO®, & SBX® housings. The genderless design holds two each of the gold plated pin & socket contacts. This innovation allows the very durable and cost effective design of SBE®, O, X connectors to substitute for DIN 43589-1 applications where 4 auxiliary contacts are required. Multiple pin lengths allow the further benefit of sequencing between circuits. (2) Retaining pins or (1) Retaining clip is required to hold the auxiliary housing in place. Auxiliary Kits include (1) Auxiliary Housing, (2) Standard Length Pin Contacts, (2) Socket Contacts, (2) Retaining Pins and (1) Retaining Clip.

Description	AWG	mm ²	----- Part Numbers -----		
Minimum Quantity			1,000	250	25 ...
1x4 Auxiliary Kit	12	4	-	-	441G3
1x4 Auxiliary Kit	16 to 14	1.5 to 2.5	-	-	441G1
1x4 Auxiliary Kit	20 to 16	0.75 to 1.5	-	-	441G2
1x4 Auxiliary Housing	Contacts Sold Separately		3-5956P1	444G1	-

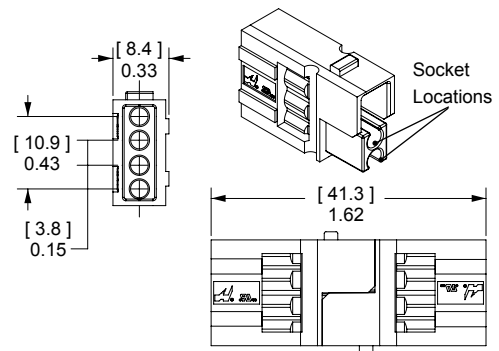

Pin Contacts for 1x4 Auxiliary Connector

Gold plated contacts are available in 4 lengths to allow sequencing of circuits.

Description	AWG	mm ²	----- Part Numbers -----	
Minimum Quantity			500	50
Standard Length 7.7mm	12	2.5	PM16P12S30	PM16P12S30-50
	16 to 14	1.0 to 1.5	PM16P1416S30	PM16P1416S30-50
	20 to 16	0.75 to 1.0	PM16P1620S30	PM16P1620S30-50
	24 to 20	0.50 to 0.75	PM16P2024S30	PM16P2024S30-50
Pre-Mate 9.3mm	12	2.5	PM16P12A30	-
	16 to 14	1.0 to 1.5	PM16P1416A30	-
	20 to 16	0.75 to 1.0	PM16P1620A30	-
	24 to 20	0.50 to 0.75	PM16P2024A30	-
Post-Mate 6.4mm	12	2.5	PM16P12C30	-
	16 to 14	1.0 to 1.5	PM16P1416C30	-
	20 to 16	0.75 to 1.0	PM16P1620C30	-
	24 to 20	0.50 to 0.75	PM16P2024C30	-



Auxiliary Pin Contact Lengths	- L -		- L1 -	
	in.	mm	in.	mm
Standard Length 7.7mm	0.77	19.6	0.30	7.7
Pre-Mate 9.3mm	0.83	21.2	0.37	9.3
Post-Mate 6.4mm	0.72	18.3	0.25	6.4

Socket Contacts for 1x4 Auxiliary Connector

Selectively gold plated contacts offer low resistance and durability up to 10,000 mating cycles.

Description	AWG	mm ²	Part Numbers	
Minimum Quantity			500	50
Socket Contact	12	2.5	PM16S12S32	PM16S12S32-50
	16 to 14	1.0 to 1.5	PM16S1416S32	PM16S1416S32-50
	20 to 16	0.75 to 1.0	PM16S1620S32	PM16S1620S32-50
	24 to 20	0.50 to 0.75	PM16S2024S32	PM16S2024S32-50

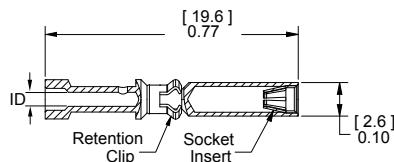

Auxiliary Socket Contacts Crimp Barrel ID		
Wire Gauge	in.	mm.
#24 / 20	0.04	1.1
#20 / 16	0.07	1.7
#16 / 14	0.08	2.1
#12	0.10	2.6

PPMX Auxiliary Connector

The PPMX auxiliary connector allows up to 8 auxiliary circuits to be used in the SBE®, SBO®, & SBX® housings. There are 4 auxiliary circuits per PPMX connector and two PPMX housings fit into the auxiliary port in the main connector housing. Rated up to 7 amps 300 volts per contact, the genderless design holds two each gold plated pin & Socket contacts. This innovation allows the very durable and cost effective design of SBE®, O, X connectors to be used for applications requiring up to 8 battery monitoring or equipment vehicle communication circuits. (2) Retaining pins or (1) Retaining clip is required to hold the auxiliary housing in place.

Auxiliary Kits includes: (1) Auxiliary Housing, (2) Pin Contacts, and (2) Socket Contacts.

Description	AWG	mm ²	Part Numbers		
Minimum Quantity			1,000	100	25
PPMX Auxiliary Kit	24 to 20	0.50 to 0.25	-	4850G6	-
1x4 Auxiliary Housing	Contacts Sold Separately		4827G6-BK	-	4827G6

* No extraction tool required for contact removal.

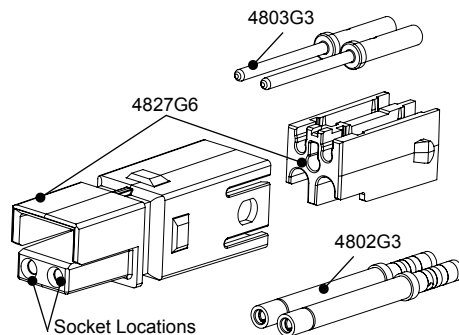

Pin & Socket Contacts for PPMX Auxiliary Connector

Gold plated contacts are ideal for signal or low power use with durability up to 5,000 mating cycles.

Description	AWG	mm ²	Part Numbers	
Minimum Quantity			2,000	50
Pin Contacts	24 to 20	0.50 to 0.25	4803G3-BK	4803G3
Socket Contacts	24 to 20	0.50 to 0.25	4802G3-BK	4802G3

SBE® Air Tubes

Air tubes fit into SBE® housings to allow electrolyte circulation while charging the battery. Genderless tube design allows the same part to be used on both sides. (2) Retaining pins or (1) Retaining clip is required to hold the air tube in place. Retaining pins are included in Air Tube Kit.

Description	Part Numbers	
Minimum Quantity	500	25
Air Tube Kit, Black	-	6396G1
Air Tube Only	3-5798P1	-

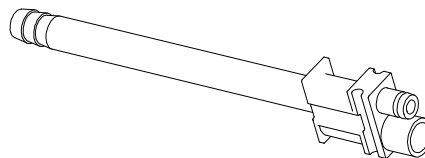

Retaining Clip

Retaining clips can be used in place of two retaining pins to hold auxiliary connectors or air tubes. Allows easier removal of auxiliary modules.

Description	Part Number
Minimum Quantity	100
For SBE®160 & SBX®175	2-8675P2

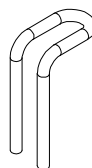

Retaining Pins

Retaining pins are used to hold accessories in the auxiliary port in SBE®, SBO®, & SBX® housings. Dimension "B" is +/- 0.015 in or 0.38 mm.

Description	--- Part Numbers ---		Dimensions			
			- A -		- B -	
			inches	mm	inches	mm
Minimum Quantity	1,000	100			
For SBE®160 & SBX®175	110G9-BK	110G9	0.093 / 0.099	2.36 / 2.51	0.85	21.59



Zip Cable Straps

Zip cable straps are used to secure auxiliary wires to the side of the main power cables.

Description	- Part Number -
Minimum Quantity ..	1,000
White	H1835P3

Use cable ties to secure auxiliary contact leads to one of the main cables.

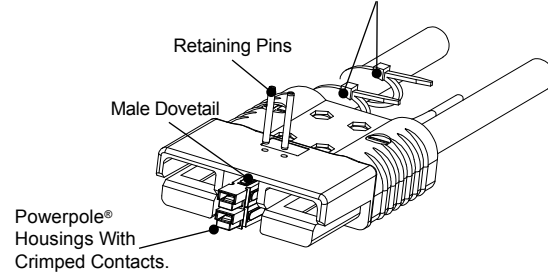

Manual Release - Battery Side

Works with the Charger / Truck side to ease mating and unmating connectors.

Description	--- Part Numbers ---	
Minimum Quantity	88	25 ...
Bracket and Hardware Kit	-	993G2
Battery Bracket Only	111961P2	-
Hardware Bag	-	105G1

Manual Release - Charger / Truck Side

Works with the Battery side to ease mating and unmating connectors.

Description	----- Part Numbers -----	
Minimum Quantity	60	25 ...
Bracket and Hardware Kit	-	994G2
Bracket / Lever Only	B00511G2	-
Hardware Bag	-	105G1



Reducing Bushings: for Use with Contact # 6384G1

Use with contact part number 6384G1-BK to allow a smaller wire to be used with the connector. Electrical capability is derated with smaller wire.

Contacts Barrel Size	Wire Size	----- Part Numbers -----				Dimensions - ID -	
		1,500	1,000	500	100	inches	mm
Minimum Quantity	
1/0 AWG [53.5 mm ²]	#1 AWG [42.4 mm ²]	-	-	5687-BK	5687	0.39	9.91
1/0 AWG [53.5 mm ²]	#2 AWG [33.6 mm ²]	5690-BK	-	-	5690	0.34	8.64
1/0 AWG [53.5 mm ²]	#4 AWG [21.2 mm ²]	-	5693-BK	-	5693	0.27	6.86
1/0 AWG [53.5 mm ²]	#6 AWG [13.3 mm ²]	-	5663-BK	-	5663	0.22	5.59
1/0 AWG [53.5 mm ²]	#10 - 8 AWG [5.3 - 8.4 mm ²]	5648-BK	-	-	5648	0.19	4.83



Reducing Bushings: for Use with Contact # 6384G2

Use with contact part number 6384G2-BK to allow a smaller wire to be used with the connector. Electrical capability is derated with smaller wire.

Contact Barrel Size	Wire Size	----- Part Numbers -----	
Minimum Quantity		1,000	100
35 mm ²	16 mm ²	5920-BK	5920

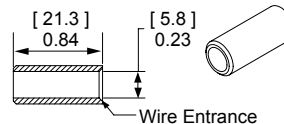

SBO® / SBE® / SBX® - Tooling Information

Wire Size		Loose Piece Part Numbers Contacts	Loose Piece Contact Crimp Tool				
AWG	mm ²		Pneumatic Bench Tool	Die	Locator	Number of Crimps	or Hand Tool
SBE® 320 / SBX® 350							
300 MCM	152	6358	N/A	N/A	N/A	N/A	1368 Series
4/0 AWG	107.2	6356	1387G2	1303G12	1304G28	Double	
3/0 AWG	85	6355					
2/0 AWG	67.4	6354					
#2	N/A	6394					
N/A	95 mm ²	1341G3	1387G2	1303G17	1304G35	Double	
N/A	70 mm ²	1341G2					
N/A	70 mm ²	1341G2					
N/A	50 mm ²	1341G1					
SBE® 160 / SBX® 175							
1/0 AWG	53.5	6384G1	1387G2	1303G2	1304G13	Single	1368 Series
#2	35 mm ²	6384G2	1387G1	1388G3	1389G3		
			1387G2	1303G2	1304G13		
SBO® 60 / SBE® 80							
#4	25	1339G4	1387G1	1388G7	1389G9	Single	N/A
#6	16	1339G1		1388G6			1309G4
Powerpole® 15/45 Auxiliary Contacts **							
#16 / 20	1.3 / .52	1332	N/A	N/A	N/A	Single	1309G2 or 1309G8
#12 / 16	3.3 / 1.3	1331					
PowerMod® 1x4 Auxiliary Contacts							
#12 / 24	2.5 / .25	All Crimp Pins	TP0001*	N/A	TL0001	Single	TM0001*
		All Crimp Sockets			TL0002		PM1000G1
PPMX Auxiliary Contacts							
#20 / 24	0.50 / 0.25	4803G3	TP0001*	N/A	TL0005	Single	TM0001* or
		4802G3					PM1000G1

* TP0001 and TM0001 tools require locators to properly position contacts.

** See Powerpole® family tooling chart for other Powerpole® contacts

SBE®160 / SBX®175 Power Contact Extraction Tool: 969P1

SBE®320 / SBX®350 Power Contact Extraction Tool: 970P1

1 x 4 Auxiliary contact Insertion Tool: PM1002G1

1 x 4 Auxiliary Contact Extraction Tool: PM1003G1

The auxiliary contacts used with wire sizes #16 - #24 AWG cannot be properly inserted without the insertion tool. Properly installed auxiliary contact of all wire gauges cannot be removed from the housing without the extraction tool.

Mouser Electronics

Authorized Distributor

Click to View Pricing, Inventory, Delivery & Lifecycle Information:

Anderson Power Products:

[5920](#) [6384G1](#) [6384G2](#) [2-7251G1](#) [2-7251G2](#) [2-7251G3](#) [2-7251G4](#) [2-7251G5](#) [2-7251G7](#) [2-8170G1](#) [2-8170G14](#)
[2-8170G2](#) [2-8170G3](#) [2-8170G4](#) [2-8170G5](#) [2-8170G7](#) [6381G1](#) [6385G1](#) [945G2](#) [E6380G1](#) [E6385G1](#) [E6390G1](#)
[969P1](#)