



1200V SiC COPACK Power Module

| | |
|------------------------|----------------|
| V_{DS} | 1200 V |
| $R_{DS,on}$ | 18 m Ω |
| $I_D (T_C=25^\circ C)$ | 113 A |
| $T_{J,max}$ | 175 $^\circ C$ |

Features

- High speed switching SiC MOSFETs
- Freewheeling SiC SBD with zero reverse recovery
- Simple to drive
- Kelvin reference for stable operation

Benefits

- Low switching losses
- Low junction to case thermal resistance
- Very rugged and easy mount
- Direct mounting to heatsink (isolated package)
- Lower Q_{RR} at high temperature

Applications

- Photovoltaic Inverter
- Battery charger
- Server power supplies
- Energy storage system

Package

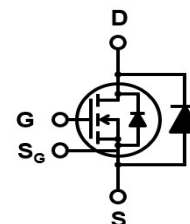

- (1) S_G (Driver Source)
 (2) G (Gate)
 (3) D (Drain)
 (4) S (Source)

| Part # | Package | Marking |
|------------------|---------|------------------|
| GCMS020B120S1-E1 | SOT-227 | GCMS020B120S1-E1 |



Absolute Maximum Ratings

| Characteristics | Symbol | Conditions | Values | Unit |
|---------------------------------|---------------------|-------------------------------|-----------|------------|
| Drain-Source Voltage | V_{rated} | $V_{GS}=0V, I_D=200\mu A$ | 1200 | V |
| Continuous Drain Current | I_{DS} | $T_C=25^\circ C, V_{GS}=20V$ | 113 | A |
| | | $T_C=100^\circ C, V_{GS}=20V$ | 81 | |
| | I_{SD}^* | $T_C=25^\circ C, V_{GS}=20V$ | 143 | |
| Schottky Diode DC Current | I_F | $T_C=25^\circ C, V_{GS}=-5V$ | 106 | V |
| Pulsed Drain Current | $I_{DS,pulse}^{**}$ | $T_C=25^\circ C, V_{GS}=20V$ | 250 | |
| Gate Source Voltage | V_{GSmax} | | -10/25 | V |
| | V_{GSop} | Recommended operational | -5/20 | |
| Power Dissipation - MOSFET | P_{tot} | $T_C=25^\circ C$ | 395 | W |
| Operating & Storage Temperature | $T_J, T_{storage}$ | Continuous | -55...175 | $^\circ C$ |

* I_{SD} maximum continuous current for parallel SBD and MOSFET body diode assuming maximum $R_{th,jc}$ of SBD

**Pulse width is limited by $T_{J,max}$

1200V SiC COPACK Power Module

GCMS020B120S1-E1

Static Electrical Characteristics, at $T_J=25^\circ\text{C}$, unless otherwise specified

| Characteristics | Symbol | Conditions | Values | | | Unit |
|---------------------------------|--------------|--|--------|------|-------|------------|
| | | | min. | typ. | max. | |
| Drain-Source Breakdown Voltage | BV_{DSS} | $V_{GS}=0V, I_D=1mA$ | 1200 | - | - | V |
| Zero Gate Voltage Drain Current | I_{DSS} | $V_{DS}=1200V, V_{GS}=0V$ | - | 5 | 100 | μA |
| | | $V_{DS}=1200V, V_{GS}=0V, T_J=175^\circ\text{C}$ | - | 159 | 750 | |
| Gate-Source Leakage Current | I_{GSS+} | $V_{GS}=20V, V_{DS}=0V$ | - | 10 | 1000 | nA |
| | I_{GSS-} | $V_{GS}=-5V, V_{DS}=0V$ | - | -10 | -1000 | |
| Gate Threshold Voltage | $V_{GS(th)}$ | $V_{GS}=V_{DS}, I_D=20mA$ | 1.8 | 2.8 | 4 | V |
| | | $V_{GS}=V_{DS}, I_D=20mA, T_J=175^\circ\text{C}$ | - | 1.7 | - | |
| Drain-Source On-Resistance | $R_{DS(on)}$ | $V_{GS}=20V, I_D=50A$ | - | 18.1 | 28 | m Ω |
| | | $V_{GS}=20V, I_D=25A$ | - | 17.6 | 26 | |
| | | $V_{GS}=20V, I_D=50A, T_J=125^\circ\text{C}$ | - | 24 | - | |
| | | $V_{GS}=20V, I_D=50A, T_J=175^\circ\text{C}$ | - | 30 | - | |
| Transconductance | g_{fs} | $V_{DS}=20V, I_D=50A$ | - | 25 | - | S |
| Internal Gate Resistance | $R_{G(int)}$ | $f=1MHz, V_{AC}=25mV, D-S$ Short | - | 0.8 | - | Ω |

AC Electrical Characteristics, at $T_J=25^\circ\text{C}$, unless otherwise specified

| Characteristics | Symbol | Conditions | Values | | | Unit |
|------------------------------|-----------------|---|---------------------------|------|------|---------|
| | | | min. | typ. | max. | |
| Input Capacitance | C_{ISS} | $V_{GS}=0V$ | - | 5279 | - | pF |
| Output Capacitance | C_{OSS}^{**} | $V_{DS}=1000V$ | - | 436 | - | |
| Reverse Transfer Capacitance | C_{RSS} | $f=200kHz$ | - | 19 | - | |
| Coss Stored Energy | E_{OSS}^{***} | $V_{AC}=25mV$ | - | 265 | - | μJ |
| Turn-On Switching Energy | E_{ON} | | - | 0.57 | - | mJ |
| Turn-Off Switching Energy | E_{OFF} | $V_{DD}=800V, I_{DS}=50A,$ $R_{G(ext)}=3.9\Omega,$ | - | 0.27 | - | |
| Turn-On Delay Time | $t_{D(on)}$ | $V_{GS}=-5/+20V, L=273\mu H,$ FWD=GCMS020B120S1-E1 | - | 25 | - | ns |
| Rise Time | t_R | | - | 8 | - | |
| Turn-Off Delay Time | $t_{D(off)}$ | | - | 46 | - | |
| Fall Time | t_F | | - | 25 | - | |
| Total Gate Charge | Q_G | | $V_{DD}=800V, I_{DS}=50A$ | - | 215 | |
| Gate to Source Charge | Q_{GS} | $V_{GS}=-5/20V$ | - | 76 | - | |
| Gate to Drain Charge | Q_{GD} | | - | 43 | - | |

** C_{OSS} is combination of MOSFET C_{OSS} and diode junction capacitance

*** E_{OSS} is calculated from C_{OSS} curve

Freewheeling Diode Characteristics, at $T_J=25^\circ\text{C}$, unless otherwise specified

| Characteristics | Symbol | Conditions | Values | | | Unit |
|-------------------------------|-----------|--|--------|------|------|------|
| | | | min. | typ. | max. | |
| Diode Forward Voltage | V_{SD} | $V_{GS}=-5V, I_S=50A$ | - | 1.49 | 1.7 | V |
| | | $V_{GS}=-5V, I_S=50A, T_J=175^\circ\text{C}$ | - | 2.13 | - | |
| Reverse Recovery Time | t_{RR} | | - | 19 | - | ns |
| Reverse Recovery Charge | Q_{RR} | $I_S=50A, V_R=800V, V_{GS}=-5V$ | - | 805 | - | nC |
| Peak Reverse Recovery Current | I_{RRM} | $di/dt=8.3A/ns$ | - | 70 | - | A |
| Reverse Recovery Energy | E_{RR} | | - | 0.49 | - | mJ |

Thermal and Package Characteristics, at $T_j=25\text{ }^\circ\text{C}$, unless otherwise specified

| Characteristics | Symbol | Conditions | Values | | | Unit |
|-----------------------------------|------------|--|--------|------|------|--------------------|
| | | | min. | typ. | max. | |
| Thermal resistance, junction-case | R_{thJC} | MOSFET only | - | 0.31 | 0.38 | $^\circ\text{C/W}$ |
| Thermal resistance, junction-case | R_{thJC} | Schottky diode only | - | 0.38 | 0.46 | |
| Mounting torque | M_d | M4-0.7 screws | 1.1 | - | 1.5 | N-m |
| Terminal connection torque | M_{dt} | M4-0.7 screws | - | 1.1 | 1.3 | |
| Package weight | W_t | | - | 32 | - | g |
| Isolation voltage | V_{ISOL} | $I_{ISOL} < 1\text{mA}$, 50/60 Hz, 2 s | 4000 | - | - | V |

Typical Performance

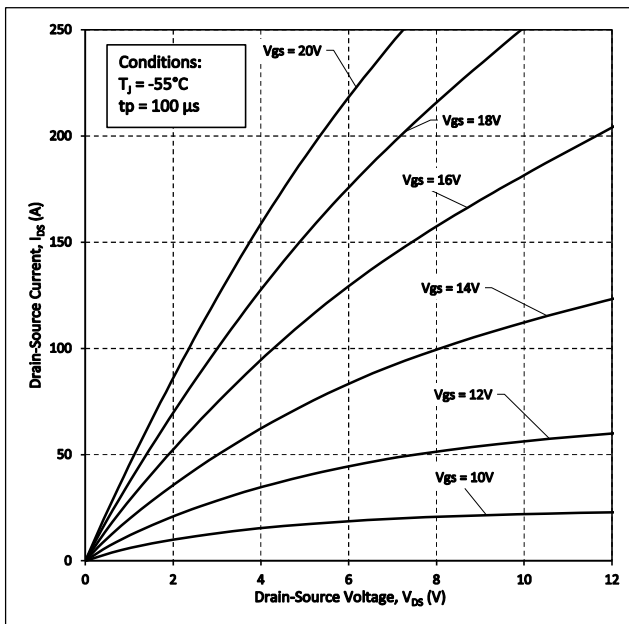

Figure 1. Output Characteristics $T_j = -55^\circ\text{C}$

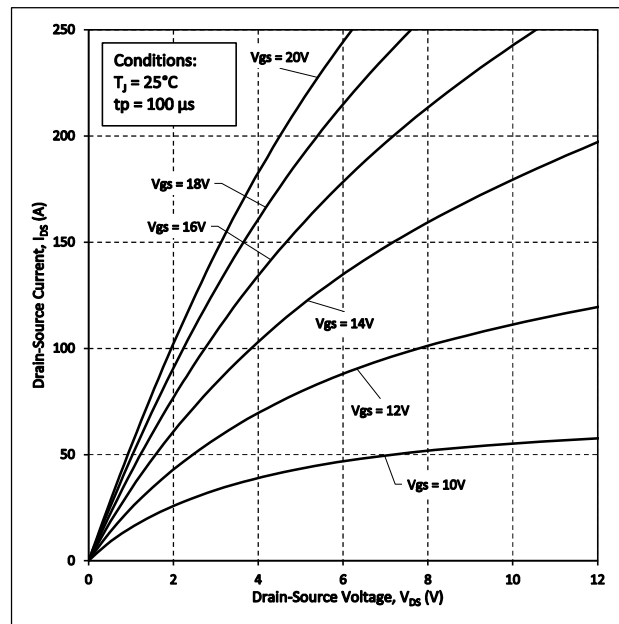

Figure 2. Output Characteristics $T_j = 25^\circ\text{C}$

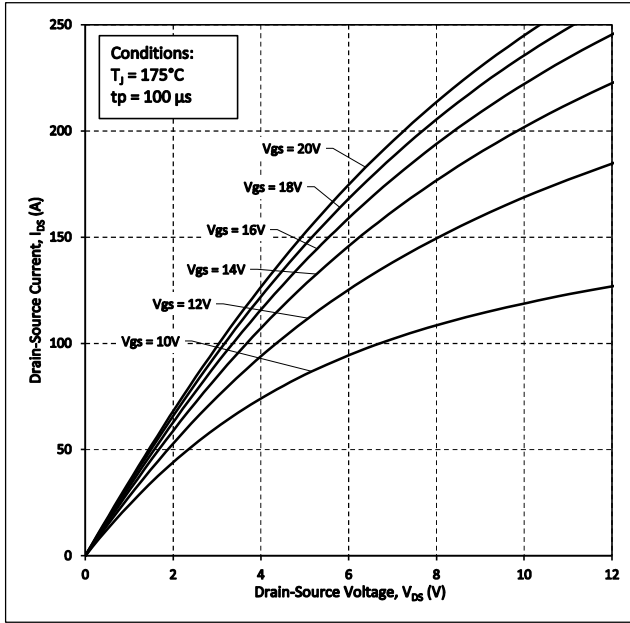

Figure 3. Output Characteristics $T_j = 175^\circ\text{C}$

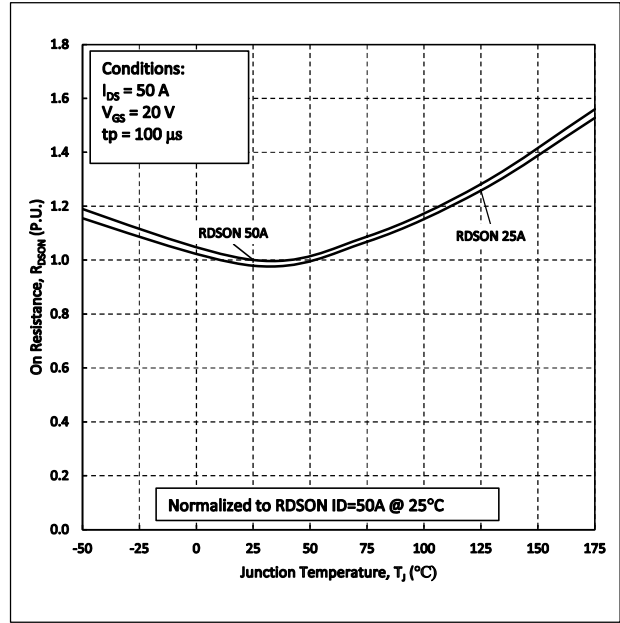

Figure 4. Normalized On-Resistance vs. Temperature

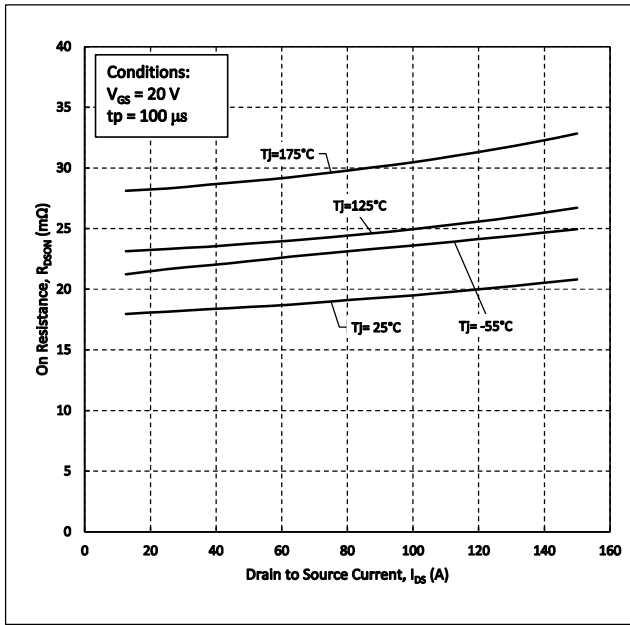

Figure 5. On-Resistance vs. Drain Current For Various Temperature

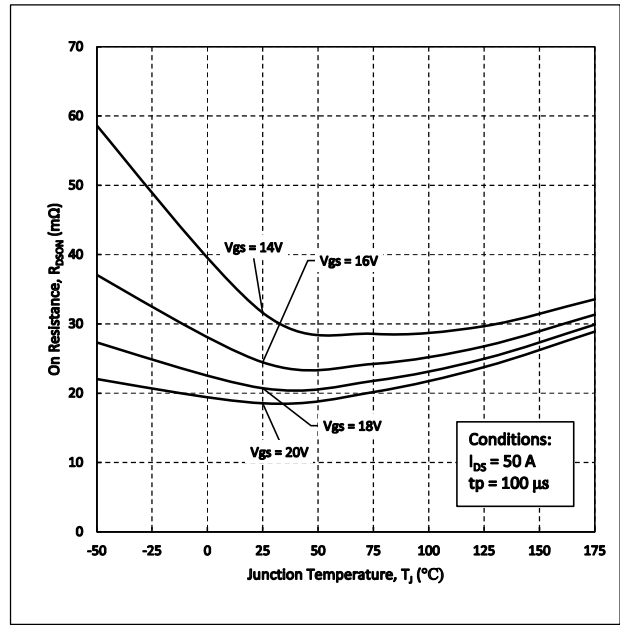

Figure 6. On-Resistance vs. Temperature For Various Gate Voltages

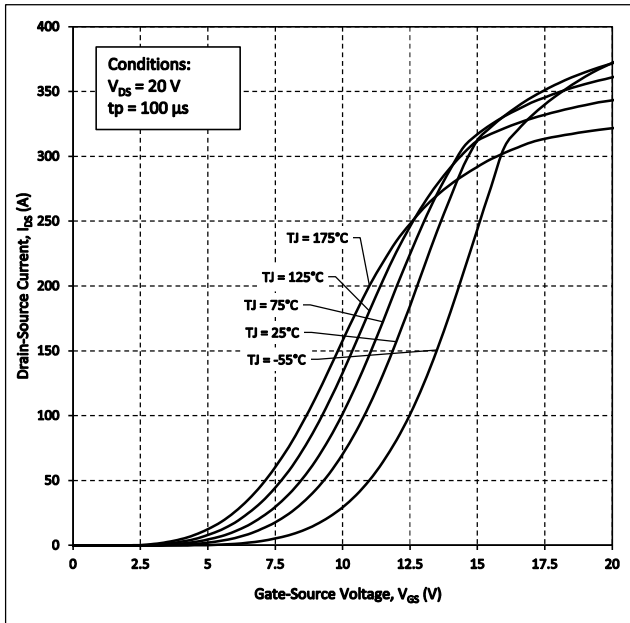

Figure 7. Transfer Characteristic for Various Junction Temperatures

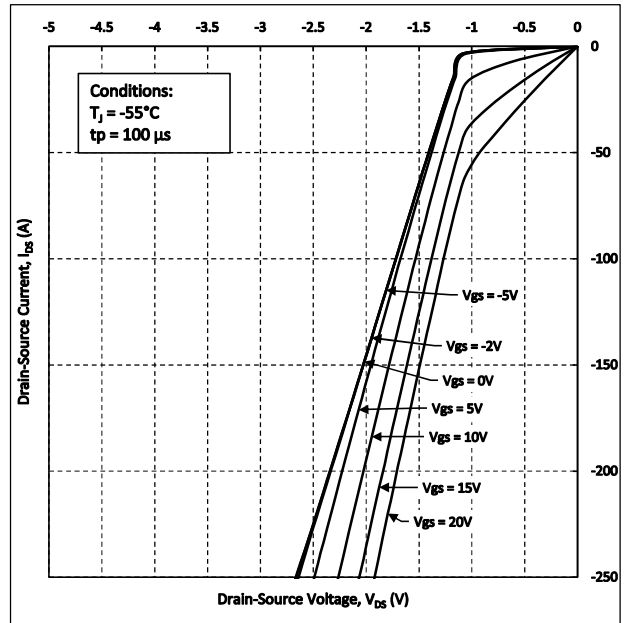

Figure 8. Freewheeling Diode Characteristics at $T_J = -55^\circ\text{C}$

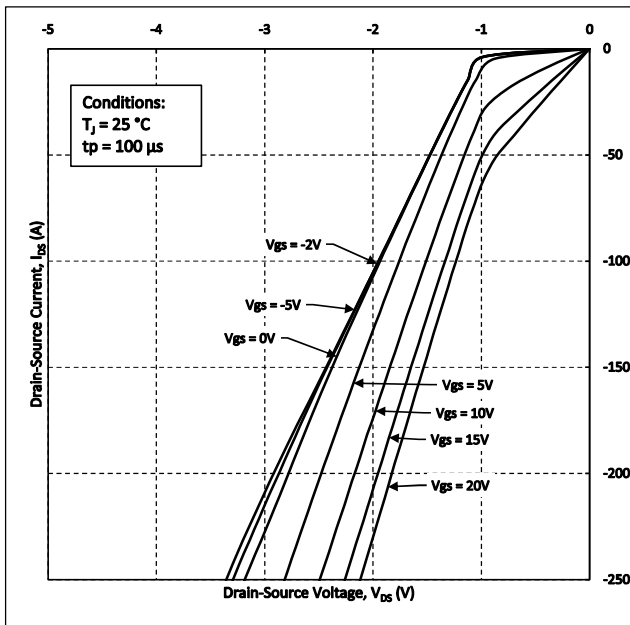

Figure 9. Freewheeling Diode Characteristics at $T_J = 25^\circ\text{C}$

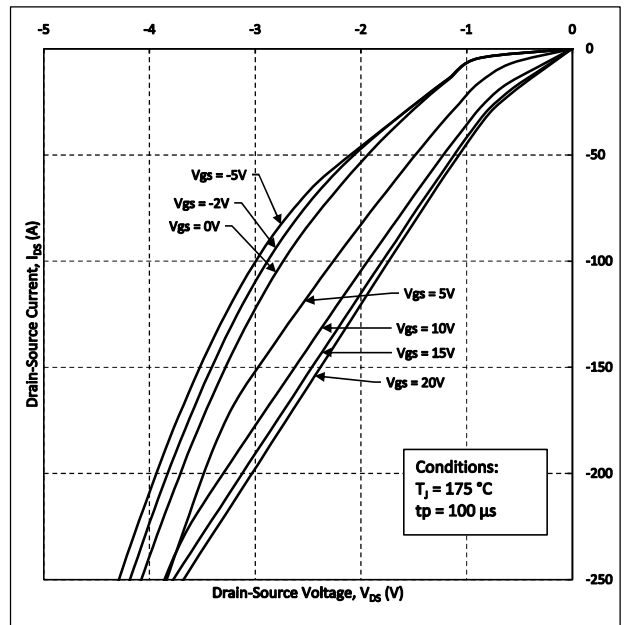

Figure 10. Freewheeling Diode Characteristics at $T_J = 175^\circ\text{C}$

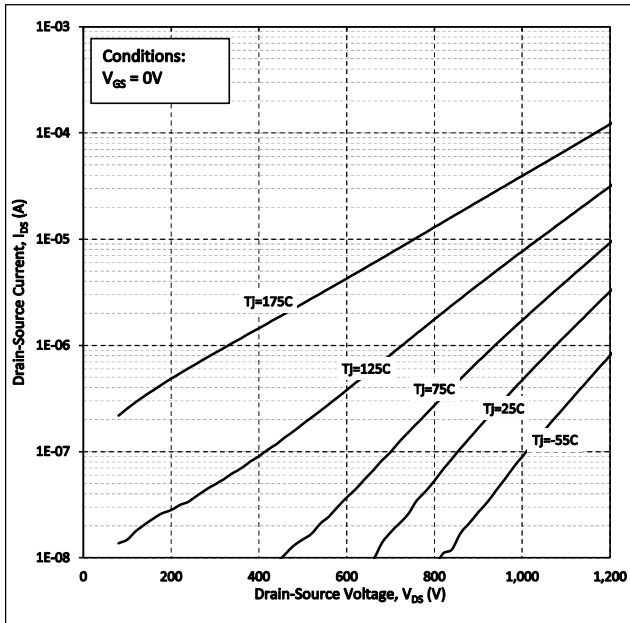

Figure 11. IDSS vs. Temperature

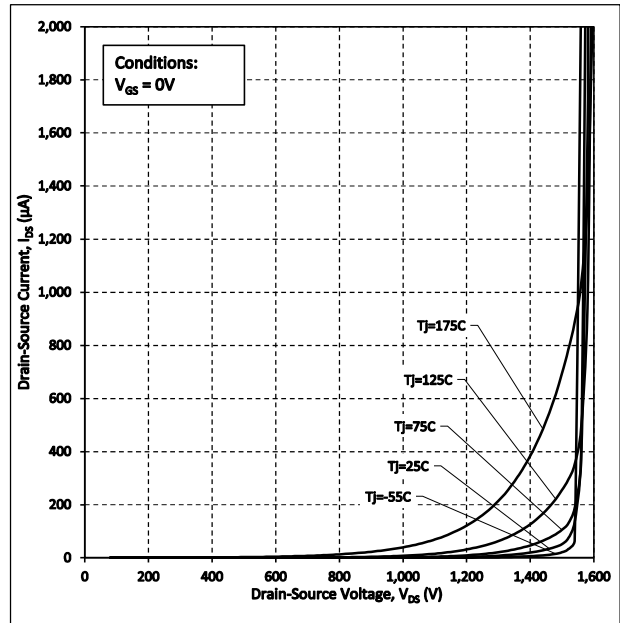

Figure 12. IDSS vs. Temperature

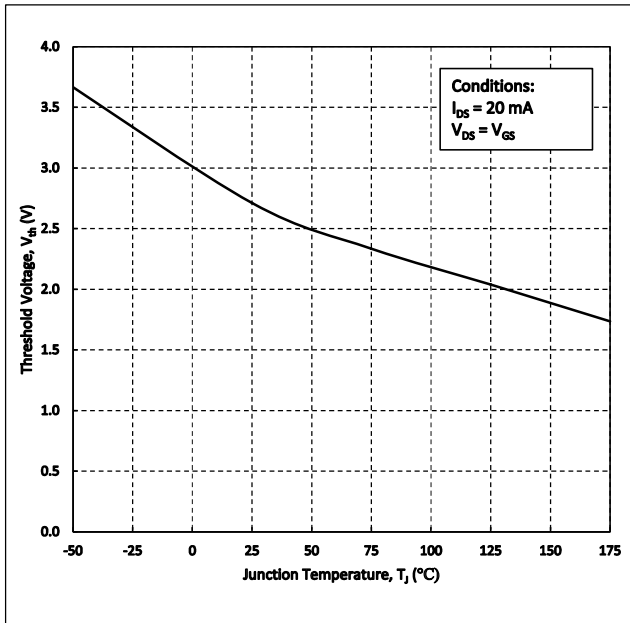

Figure 13. Threshold Voltage vs. Temperature

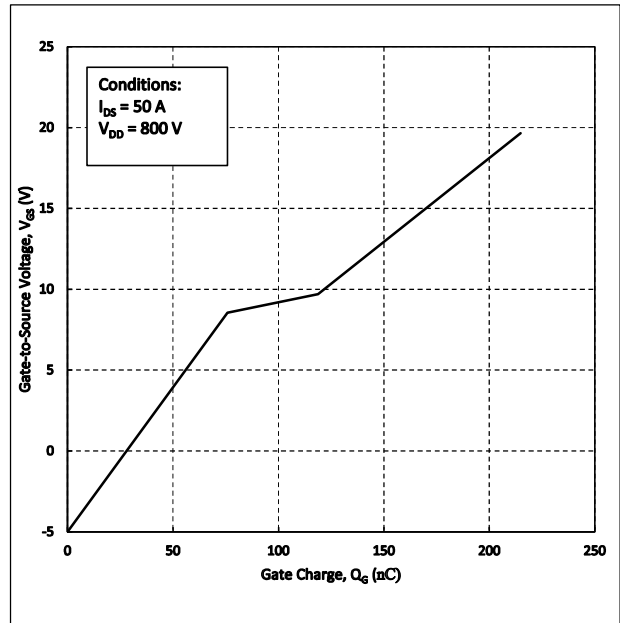

Figure 14. Gate Charge Characteristics

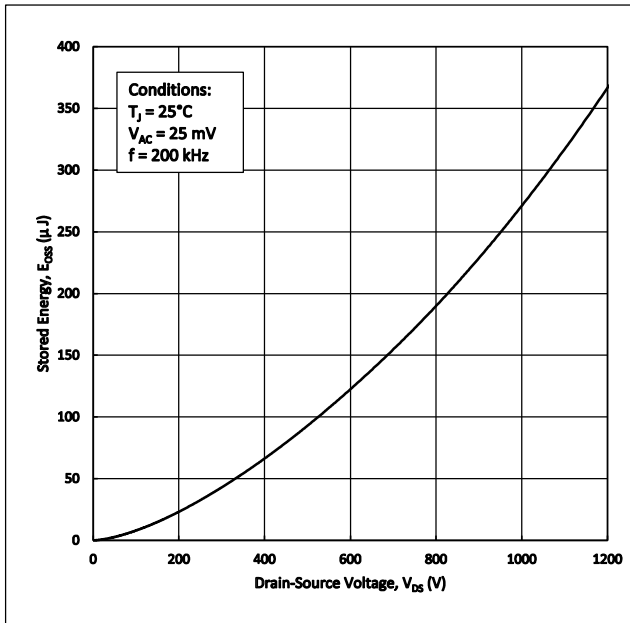

Figure 15. Output Capacitor Stored Energy

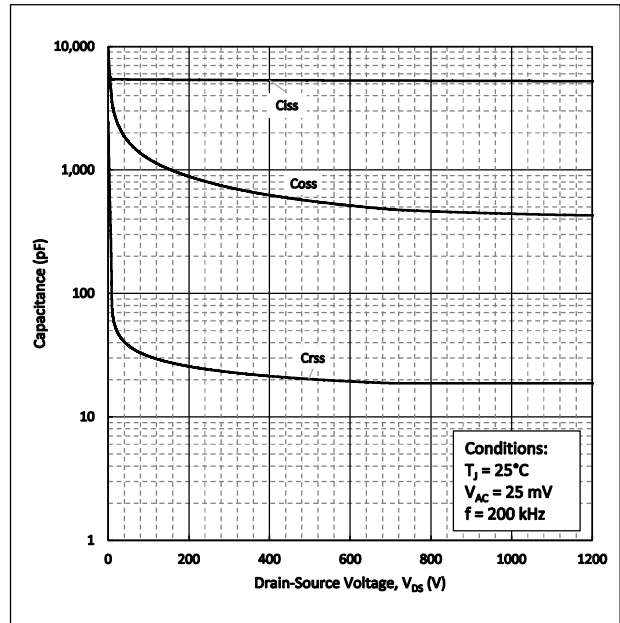

Figure 16. Capacitance vs Drain-Source Voltage

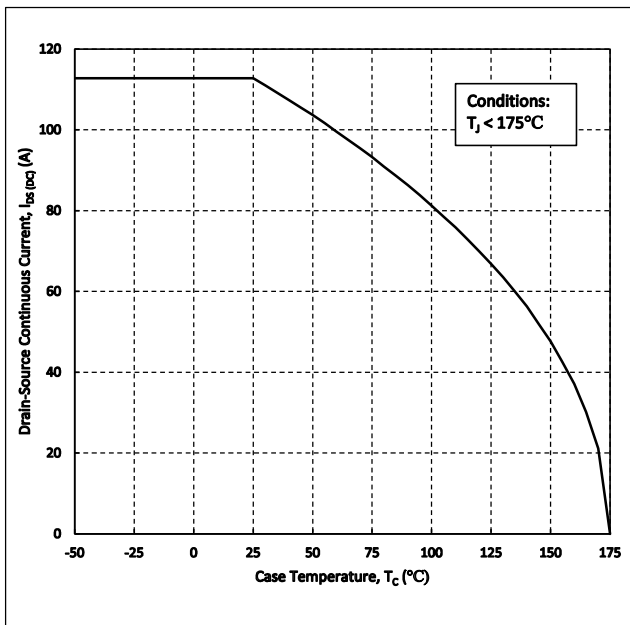

Figure 17. Continuous Drain Current Derating vs. Case Temperature

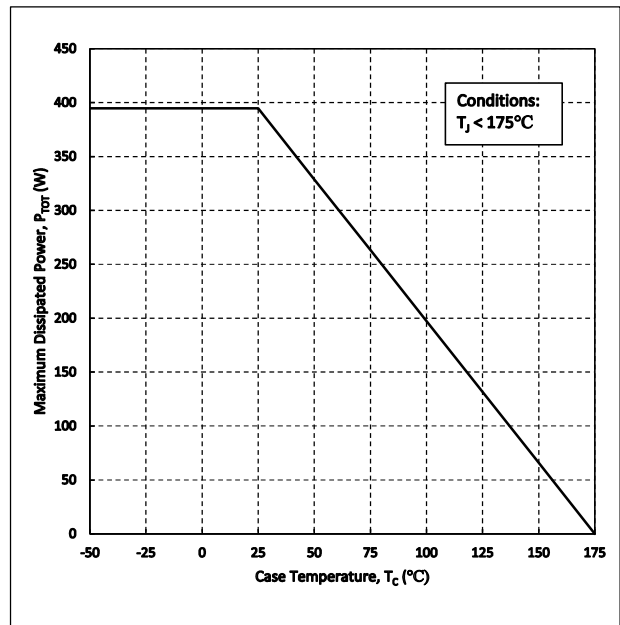

Figure 18. Maximum Power Dissipation Derating vs Case Temperature

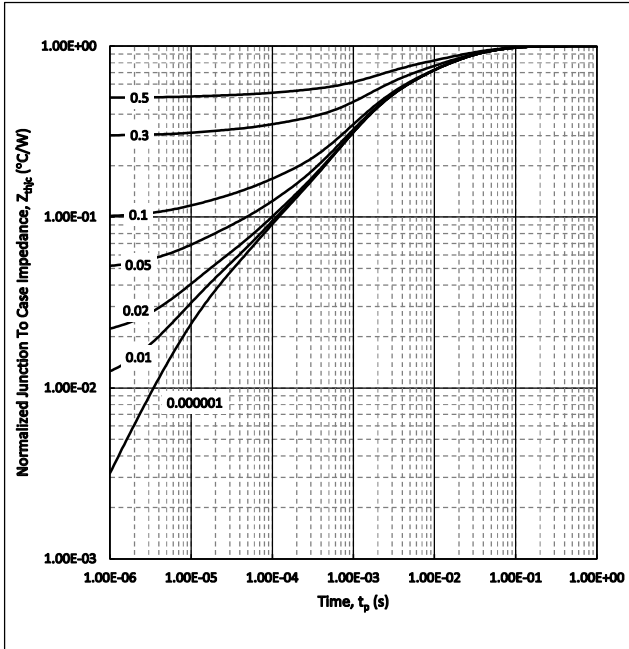

Figure 19. Transient Thermal impedance (Junction to Case)

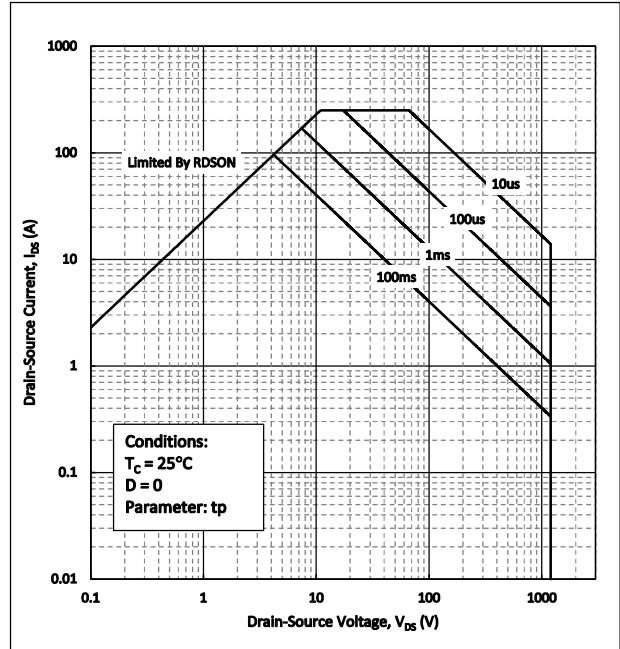

Figure 20. Safe Operating Area

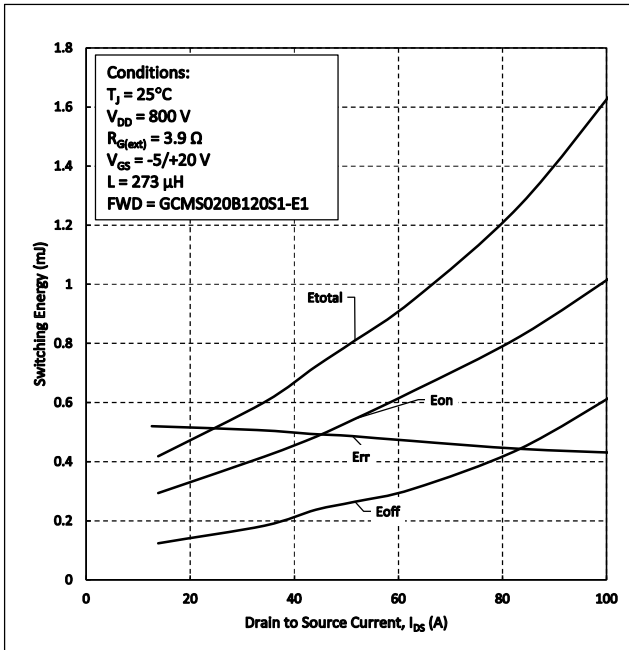

Figure 21. Clamped Inductive Switching Energy vs. Drain Current

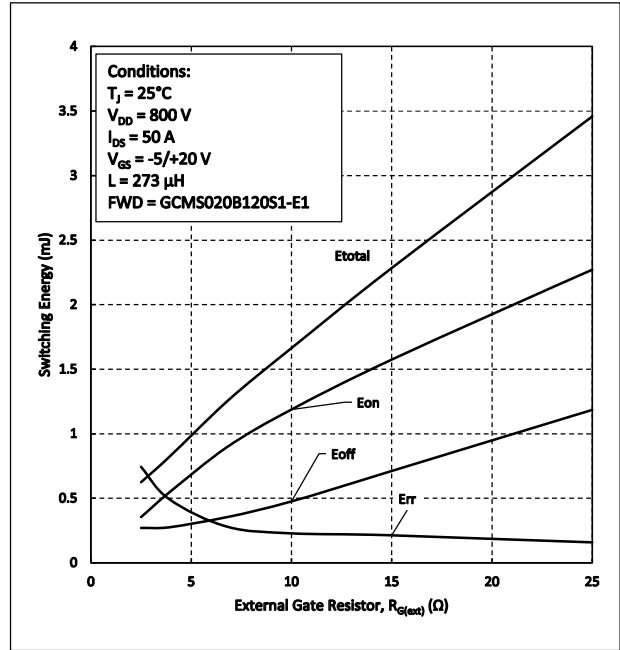

Figure 22. Clamped Inductive Switching Energy vs. $R_{G(ext)}$

1200V SiC COPACK Power Module

GCMS020B120S1-E1

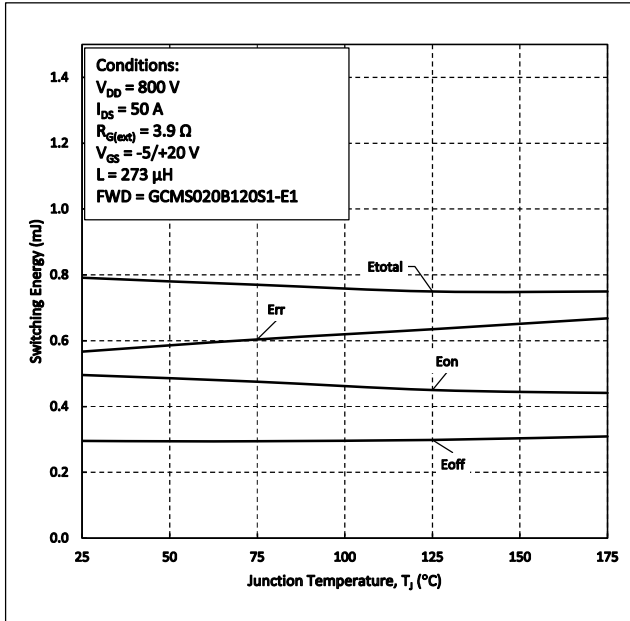

Figure 23. Clamped Inductive Switching Energy vs. Temperature

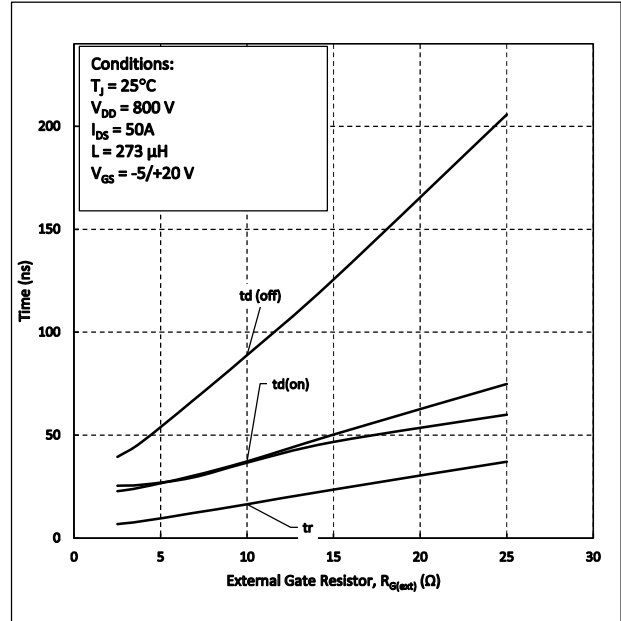

Figure 24. Switching Times vs $R_{G(\text{ext})}$

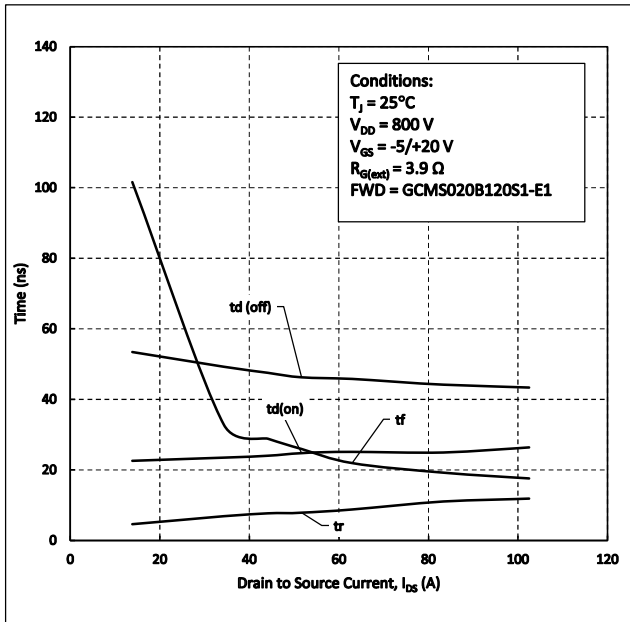

Figure 25. Switching Times vs. Drain Current

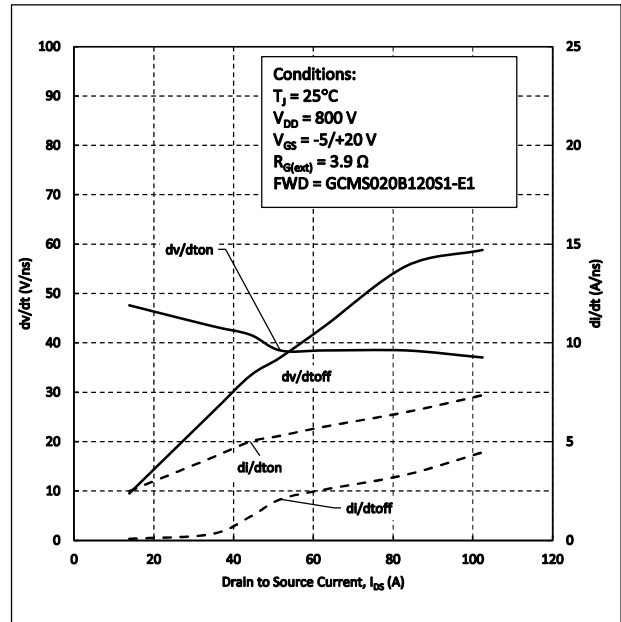

Figure 26. dv/dt and di/dt vs. Drain Current

1200V SiC COPACK Power Module

GCMS020B120S1-E1

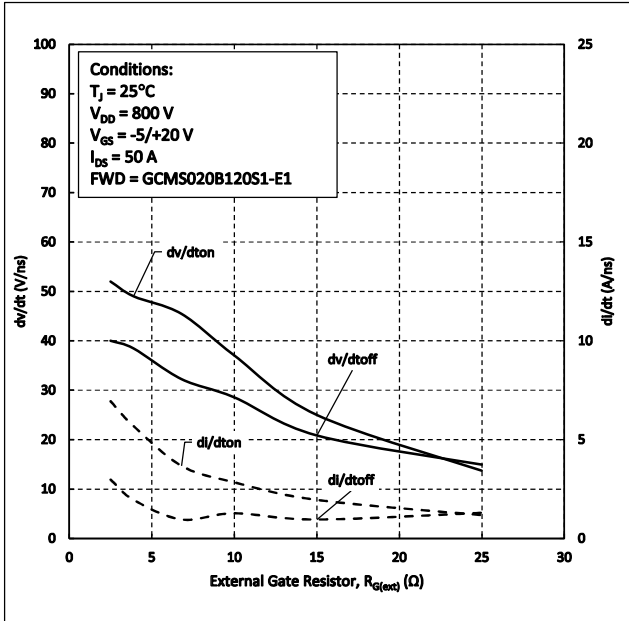

Figure 27. dv/dt and di/dt vs. $R_{G(ext)}$

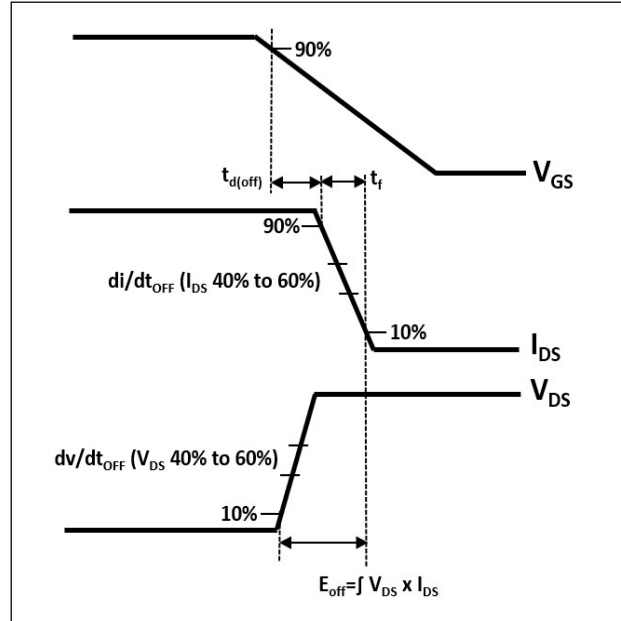

Figure 28. Turn-off Transient Definitions

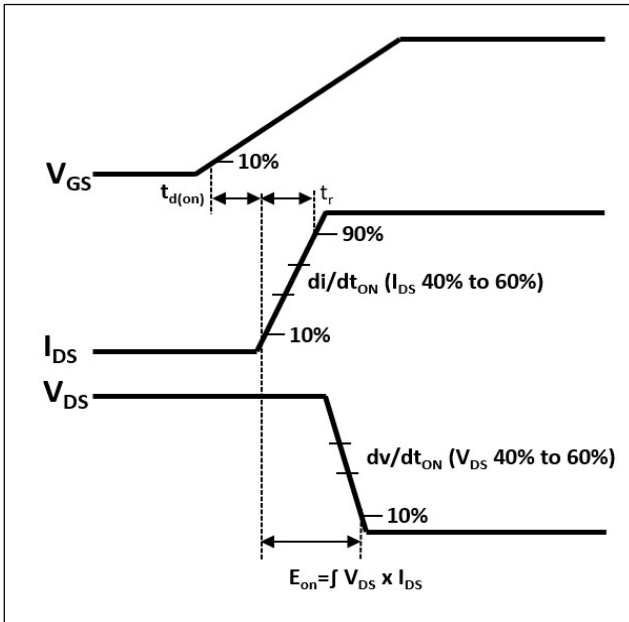

Figure 29. Turn-on Transient Definitions

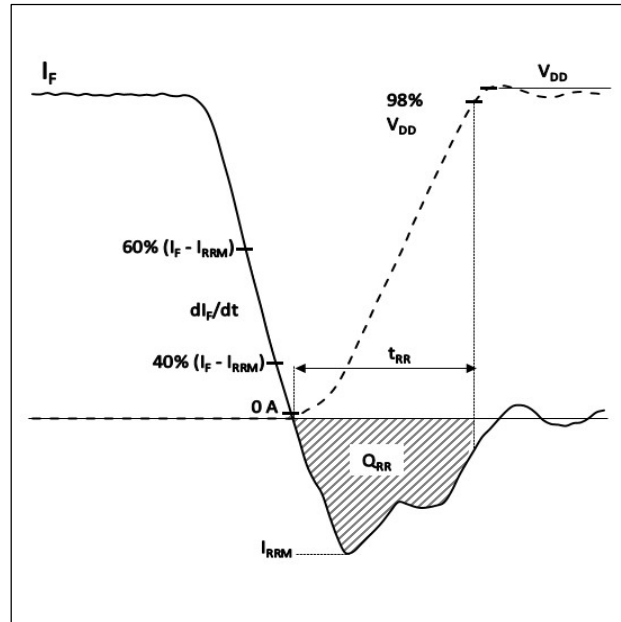
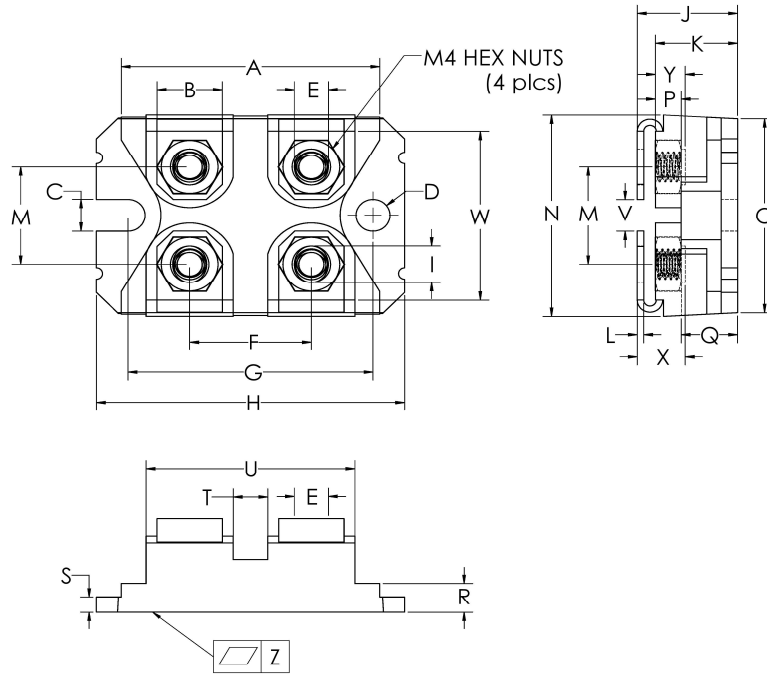

Figure 30. Reverse Recovery Definitions

1200V SiC COPACK Power Module

GCMS020B120S1-E1

Package Dimensions SOT-227



| Sym | Millimeters | | Inches | |
|-----|-------------|-------|--------|-------|
| | Min | Max | Min | Max |
| A | 31.67 | 31.90 | 1.247 | 1.256 |
| B | 7.95 | 8.18 | 0.313 | 0.322 |
| C | 4.14 | 4.24 | 0.163 | 0.167 |
| D | 4.14 | 4.24 | 0.163 | 0.167 |
| E | 4.14 | 4.24 | 0.163 | 0.167 |
| F | 14.94 | 15.09 | 0.588 | 0.594 |
| G | 30.15 | 30.25 | 1.187 | 1.191 |
| H | 38.00 | 38.10 | 1.496 | 1.500 |
| I | 4.75 | 4.83 | 0.187 | 0.190 |
| J | 11.68 | 12.19 | 0.460 | 0.480 |
| K | 9.45 | 9.60 | 0.372 | 0.378 |
| L | 0.76 | 0.84 | 0.030 | 0.033 |
| M | 12.62 | 12.88 | 0.497 | 0.507 |
| N | 25.15 | 25.30 | 0.990 | 0.996 |
| O | 24.79 | 25.04 | 0.976 | 0.986 |
| P | 3.02 | 3.15 | 0.119 | 0.124 |
| Q | 6.71 | 6.96 | 0.264 | 0.274 |
| R | 4.17 | 4.42 | 0.164 | 0.174 |
| S | 2.08 | 2.13 | 0.082 | 0.084 |
| T | 3.28 | 3.63 | 0.129 | 0.143 |
| U | 26.75 | 26.90 | 1.053 | 1.059 |
| V | 3.86 | 4.24 | 0.152 | 0.167 |
| W | 20.55 | 26.90 | 0.809 | 0.814 |
| X | 5.45 | 5.85 | 0.215 | 0.230 |
| Y | 3.15 | 3.66 | 0.124 | 0.144 |
| Z | 0.00 | 0.13 | 0.000 | 0.005 |

| Revision History | | |
|------------------|----------|-----------------------------|
| Date | Revision | Notes |
| 4/29/2022 | 0.1 | Preliminary release |
| 9/28/2022 | 0.2 | Updated switching test data |
| 8/4/2023 | 1.0 | Initial Release |
| | | |
| | | |
| | | |
| | | |

Notes

RoHS Compliance

The levels of RoHS restricted materials in this product are below the maximum concentration values (also referred to as the threshold limits) permitted for such substances, or are used in an exempted application, in accordance with EU Directive 2011/65/EC (RoHS2), as implemented March, 2013. RoHS Declarations for this product can be obtained from the Product Documentation sections of www.SemiQ.com.

REACH Compliance

REACH substances of high concern (SVHC) information is available for this product. Since the European Chemicals Agency (ECHA) has published notice of their intent to frequently revise the SVHC listing for the foreseeable future, please contact our office at SemiQ Headquarters in Lake Forest, California to insure you get the most up-to-date REACH SVHC Declaration. REACH banned substance information (REACH Article 67) is also available upon request.

SemiQ Inc., reserves the right to make changes to the product specifications and data in this document without notice. SemiQ products are sold pursuant to SemiQ's terms and conditions of sale in place at the time of order acknowledgement.

This product has not been designed or tested for use in, and is not intended for use in, applications implanted into the human body nor in applications in which failure of the product could lead to death, personal injury or property damage, including but not limited to equipment used in the operation of nuclear facilities, life-support machines, cardiac defibrillators or similar emergency medical equipment, aircraft navigation or communication or control systems, or air traffic control.

SemiQ makes no warranty, representation or guarantee regarding the suitability of its products for any particular purpose, nor does SemiQ assume any liability arising out of the application or use of any product or circuit, and specifically disclaims any and all liability, including without limitation special, consequential or incidental damages. Buyer is responsible for its products and applications using SemiQ products.

To obtain additional technical information or to place an order for this product, please contact us. The information in this datasheet is provided by SemiQ. SemiQ reserves the right to make changes, corrections, modifications, and improvements of datasheet without notice.