

## DRV5056 unipolar ratiometric linear hall effect sensor

### 1 Features

- Unipolar linear hall effect magnetic sensor
- Operates from 3.3-V and 5-V power supplies
- Analog output with 0.6-V quiescent offset:
  - Maximizes voltage swing for high accuracy
- Magnetic sensitivity options (at  $V_{CC} = 5\text{ V}$ ):
  - A1: 200 mV/mT, 20-mT range
  - A2: 100 mV/mT, 39-mT range
  - A3: 50 mV/mT, 79-mT range
  - A4: 25 mV/mT, 158-mT range
  - A6: 100 mV/mT, 39-mT range
- Fast 20-kHz sensing bandwidth
- Low-noise output with  $\pm 1\text{-mA}$  drive
- Compensation for magnet temperature drift
- Standard industry packages:
  - Surface-mount SOT-23
  - Through-hole TO-92

### 2 Applications

- Precise position sensing
- Industrial automation and robotics
- Home appliances
- Gamepads, pedals, keyboards, triggers
- Height leveling, tilt and weight measurement
- Fluid flow rate measurement
- Medical devices
- Current sensing

### 3 Description

The DRV5056 is a linear Hall effect sensor that responds proportionally to flux density of a magnetic south pole. The device can be used for accurate position sensing in a wide range of applications.

Featuring a unipolar magnetic response, the analog output drives 0.6 V when no magnetic field is present, and increases when a south magnetic pole is applied. This response maximizes the output dynamic range in applications that sense one magnetic pole. Four sensitivity options further maximize the output swing based on the required sensing range.

The device operates from 3.3-V or 5-V power supplies. Magnetic flux perpendicular to the top of the package is sensed, and the two package options provide different sensing directions.

The device uses a ratiometric architecture that can minimize error from  $V_{CC}$  tolerance when the external analog-to-digital converter (ADC) uses the same  $V_{CC}$  for its reference. Additionally, the device features magnet temperature compensation to counteract how magnets drift for linear performance across a wide temperature range.

The A1 to A4 options support a temperature range of  $-40^{\circ}\text{C}$  to  $+125^{\circ}\text{C}$ . The A6 version supports a temperature range of  $0^{\circ}\text{C}$  to  $85^{\circ}\text{C}$ .

#### Device Information<sup>(1)</sup>

PART NUMBER	PACKAGE	BODY SIZE (NOM)
DRV5056	SOT-23 (3)	2.92 mm x 1.30 mm
	TO-92 (3)	4.00 mm x 3.15 mm

(1) For all available packages, see the package option addendum at the end of the data sheet.

#### Typical Schematic

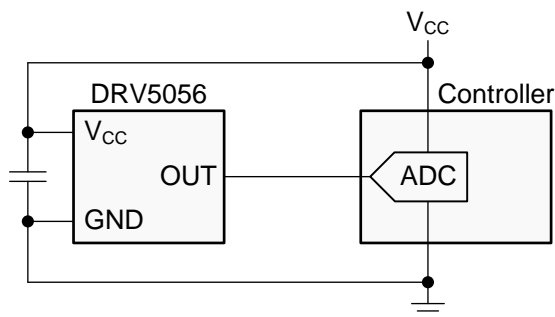

#### Magnetic Response

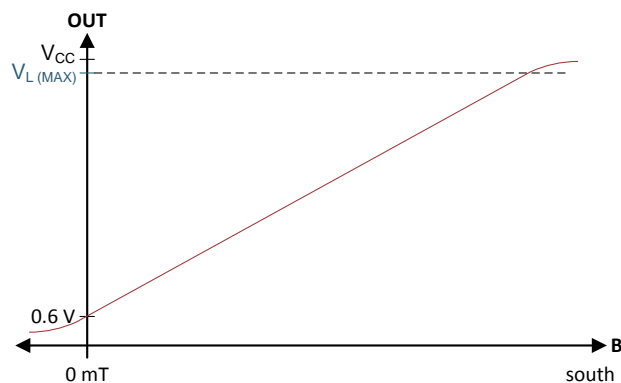

## Table of Contents

<b>1 Features</b> .....	<b>1</b>	7.4 Device Functional Modes.....	<b>13</b>
<b>2 Applications</b> .....	<b>1</b>	<b>8 Application and Implementation</b> .....	<b>14</b>
<b>3 Description</b> .....	<b>1</b>	8.1 Application Information.....	<b>14</b>
<b>4 Revision History</b> .....	<b>2</b>	8.2 Typical Application .....	<b>15</b>
<b>5 Pin Configuration and Functions</b> .....	<b>3</b>	8.3 What to Do and What Not to Do .....	<b>17</b>
<b>6 Specifications</b> .....	<b>3</b>	<b>9 Power Supply Recommendations</b> .....	<b>19</b>
6.1 Absolute Maximum Ratings .....	<b>3</b>	<b>10 Layout</b> .....	<b>19</b>
6.2 ESD Ratings.....	<b>4</b>	10.1 Layout Guidelines .....	<b>19</b>
6.3 Recommended Operating Conditions.....	<b>4</b>	10.2 Layout Examples.....	<b>19</b>
6.4 Thermal Information .....	<b>4</b>	<b>11 Device and Documentation Support</b> .....	<b>20</b>
6.5 Electrical Characteristics.....	<b>4</b>	11.1 Documentation Support .....	<b>20</b>
6.6 Magnetic Characteristics.....	<b>5</b>	11.2 Receiving Notification of Documentation Updates	<b>20</b>
6.7 Typical Characteristics.....	<b>6</b>	11.3 Community Resources.....	<b>20</b>
<b>7 Detailed Description</b> .....	<b>9</b>	11.4 Trademarks .....	<b>20</b>
7.1 Overview .....	<b>9</b>	11.5 Electrostatic Discharge Caution.....	<b>20</b>
7.2 Functional Block Diagram .....	<b>9</b>	11.6 Glossary .....	<b>20</b>
7.3 Feature Description.....	<b>9</b>	<b>12 Mechanical, Packaging, and Orderable Information</b> .....	<b>20</b>

## 4 Revision History

NOTE: Page numbers for previous revisions may differ from page numbers in the current version.

### Changes from Original (April 2018) to Revision A

Page

- |   |          |
|---|----------|
| • Added new A6 magnetic sensitivity option to the data sheet..... | <b>1</b> |
|---|----------|

## 5 Pin Configuration and Functions

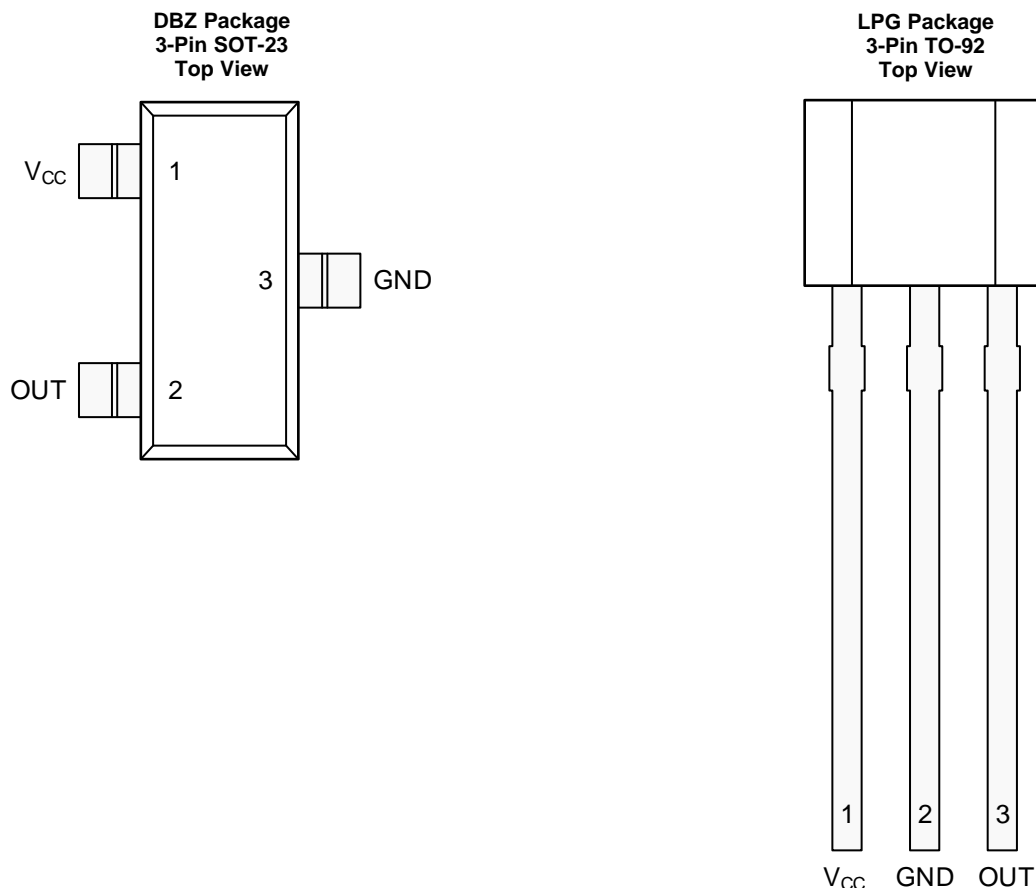

### Pin Functions

NAME	PIN		I/O	DESCRIPTION
	SOT-23	TO-92		
GND	3	2	—	Ground reference
OUT	2	3	O	Analog output
V <sub>CC</sub>	1	1	—	Power supply. TI recommends connecting this pin to a ceramic capacitor to ground with a value of at least 0.1 $\mu$ F.

## 6 Specifications

### 6.1 Absolute Maximum Ratings

over operating free-air temperature range (unless otherwise noted)<sup>(1)</sup>

		MIN	MAX	UNIT
Power supply voltage	V <sub>CC</sub>	-0.3	7	V
Output voltage	OUT	-0.3	V <sub>CC</sub> + 0.3	V
Magnetic flux density, B <sub>MAX</sub>		Unlimited		T
Operating junction temperature, T <sub>J</sub>		-40	150	°C
Storage temperature, T <sub>stg</sub>		-65	150	°C

(1) Stresses beyond those listed under *Absolute Maximum Ratings* may cause permanent damage to the device. These are stress ratings only, which do not imply functional operation of the device at these or any other conditions beyond those indicated under *Recommended Operating Conditions*. Exposure to absolute-maximum-rated conditions for extended periods may affect device reliability.

## 6.2 ESD Ratings

			VALUE	UNIT
V <sub>(ESD)</sub>	Electrostatic discharge	Human-body model (HBM), per ANSI/ESDA/JEDEC JS-001 <sup>(1)</sup>	±2500	V
		Charged-device model (CDM), per JEDEC specification JESD22-C101 <sup>(2)</sup>	±750	

(1) JEDEC document JEP155 states that 500-V HBM allows safe manufacturing with a standard ESD control process.

(2) JEDEC document JEP157 states that 250-V CDM allows safe manufacturing with a standard ESD control process.

## 6.3 Recommended Operating Conditions

over operating free-air temperature range (unless otherwise noted)

		MIN	MAX	UNIT
V <sub>CC</sub>	Power supply voltage <sup>(1)</sup>	3	3.6	V
		4.5	5.5	
I <sub>O</sub>	Output continuous current	–1	1	mA
T <sub>A</sub>	A1-A4 versions operating ambient temperature <sup>(2)</sup>	–40	125	°C
T <sub>A</sub>	A6 version operating ambient temperature <sup>(2)</sup>	0	85	°C

(1) There are two isolated operating V<sub>CC</sub> ranges. For more information see the [Operating V<sub>CC</sub> Ranges](#) section.

(2) Power dissipation and thermal limits must be observed.

## 6.4 Thermal Information

THERMAL METRIC <sup>(1)</sup>		DRV5056		UNIT
		SOT-23 (DBZ)	TO-92 (LPG)	
		3 PINS	3 PINS	
R <sub>θJA</sub>	Junction-to-ambient thermal resistance	170	121	°C/W
R <sub>θJC(top)</sub>	Junction-to-case (top) thermal resistance	66	67	°C/W
R <sub>θJB</sub>	Junction-to-board thermal resistance	49	97	°C/W
Y <sub>JT</sub>	Junction-to-top characterization parameter	1.7	7.6	°C/W
Y <sub>JB</sub>	Junction-to-board characterization parameter	48	97	°C/W

(1) For more information about traditional and new thermal metrics, see the [Semiconductor and IC Package Thermal Metrics](#) application report.

## 6.5 Electrical Characteristics

for V<sub>CC</sub> = 3 V to 3.63 V and 4.5 V to 5.5 V, over operating free-air temperature range (unless otherwise noted)

PARAMETER		TEST CONDITIONS <sup>(1)</sup>		MIN	TYP	MAX	UNIT
I <sub>CC</sub>	Operating supply current				6	10	mA
t <sub>ON</sub>	Power-on time (see <a href="#">Figure 19</a> )	B = 0 mT, no load on OUT			150	300	μs
f <sub>BW</sub>	Sensing bandwidth				20		kHz
t <sub>d</sub>	Propagation delay time	From change in B to change in OUT			10		μs
B <sub>ND</sub>	Input-referred RMS noise density	V <sub>CC</sub> = 5 V			130		nT/√Hz
		V <sub>CC</sub> = 3.3 V			215		
B <sub>N</sub>	Input-referred noise	B <sub>ND</sub> × 6.6 × √20 kHz	V <sub>CC</sub> = 5 V		0.12		mT <sub>PP</sub>
			V <sub>CC</sub> = 3.3 V		0.2		
V <sub>N</sub>	Output-referred noise <sup>(2)</sup>	B <sub>N</sub> × S	DRV5056A1		24		mV <sub>PP</sub>
			DRV5056A2, DRV5056A6		12		
			DRV5056A3		6		
			DRV5056A4		3		

(1) B is the applied magnetic flux density.

(2) V<sub>N</sub> describes voltage noise on the device output. If the full device bandwidth is not needed, noise can be reduced with an RC filter.

## 6.6 Magnetic Characteristics

for  $V_{CC} = 3\text{ V to }3.63\text{ V}$  and  $4.5\text{ V to }5.5\text{ V}$ , over operating free-air temperature range (unless otherwise noted)

PARAMETER		TEST CONDITIONS <sup>(1)</sup>		MIN	TYP	MAX	UNIT
$V_Q$	Quiescent voltage	$B = 0\text{ mT}$ , $T_A = 25^\circ\text{C}$	DRV5056A1	0.535	0.6	0.665	V
			DRV5056A2, DRV5056A6	0.54	0.6	0.66	
			DRV5056A3, DRV5056A4	0.55	0.6	0.65	
$V_{Q\Delta T}$	Quiescent voltage temperature drift	$B = 0\text{ mT}$ , $T_A = -40^\circ\text{C to }125^\circ\text{C}$ versus $25^\circ\text{C}$	$V_{CC} = 5\text{ V}$	0.08		V	
			$V_{CC} = 3.3\text{ V}$	0.04			
$V_{Q\Delta L}$	Quiescent voltage lifetime drift	High-temperature operating stress for 1000 hours	< 0.5%				
S	Sensitivity	$V_{CC} = 5\text{ V}$ , $T_A = 25^\circ\text{C}$	DRV5056A1	190	200	210	mV/mT
			DRV5056A2, DRV5056A6	95	100	105	
			DRV5056A3	47.5	50	52.5	
			DRV5056A4	23.8	25	26.2	
		$V_{CC} = 3.3\text{ V}$ , $T_A = 25^\circ\text{C}$	DRV5056A1	114	120	126	
			DRV5056A2, DRV5056A6	57	60	63	
			DRV5056A3	28.5	30	31.5	
			DRV5056A4	14.3	15	15.8	
$B_L$	Linear magnetic sensing range <sup>(2)</sup>	$V_{CC} = 5\text{ V}$ , $T_A = 25^\circ\text{C}$	DRV5056A1	20			mT
			DRV5056A2, DRV5056A6	39			
			DRV5056A3	79			
			DRV5056A4	158			
		$V_{CC} = 3.3\text{ V}$ , $T_A = 25^\circ\text{C}$	DRV5056A1	19			
			DRV5056A2, DRV5056A6	39			
			DRV5056A3	78			
			DRV5056A4	155			
$V_L$	Linear range of output voltage <sup>(3)</sup>		$V_Q$		$V_{CC} - 0.2$	V	
$S_{TC}$	Sensitivity temperature compensation for magnets <sup>(4)</sup>	DRV5056A6	0.05	0.12	0.19	%/°C	
$S_{TC}$	Sensitivity temperature compensation for magnets <sup>(4)</sup>	DRV5056A1, DRV5056A2, DRV5056A3, DRV5056A4		0.12		%/°C	
$S_{LE}$	Sensitivity linearity error <sup>(3)</sup>	$V_{OUT}$ is within $V_L$		$\pm 1\%$			
$S_{RE}$	Sensitivity ratiometry error <sup>(5)</sup>	$T_A = 25^\circ\text{C}$ , with respect to $V_{CC} = 3.3\text{ V}$ or $5\text{ V}$	-2.5%		2.5%		
$S_{\Delta L}$	Sensitivity lifetime drift	High-temperature operating stress for 1000 hours	< 0.5%				

(1) B is the applied magnetic flux density.

(2)  $B_L$  describes the minimum linear sensing range at  $25^\circ\text{C}$  taking into account the maximum  $V_Q$  and Sensitivity tolerances.

(3) See the [Sensitivity Linearity](#) section.

(4)  $S_{TC}$  describes the rate the device increases Sensitivity with temperature. For more information, see the [Sensitivity Temperature Compensation For Magnets](#) section.

(5) See the [Ratiometric Architecture](#) section.

### 6.7 Typical Characteristics

at  $T_A = 25^\circ\text{C}$  (unless otherwise noted)

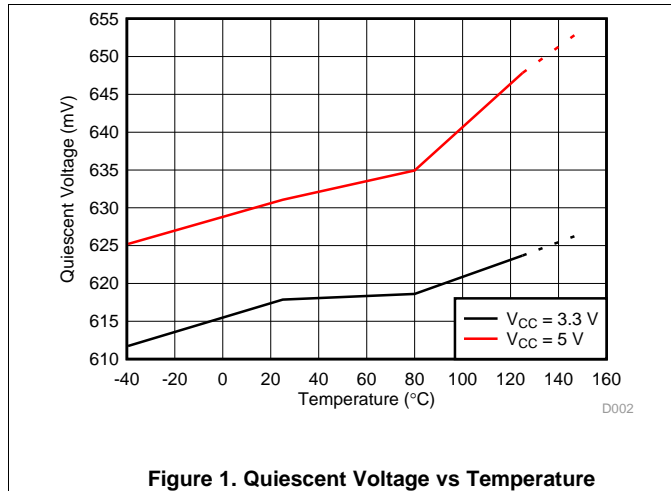

Figure 1. Quiescent Voltage vs Temperature

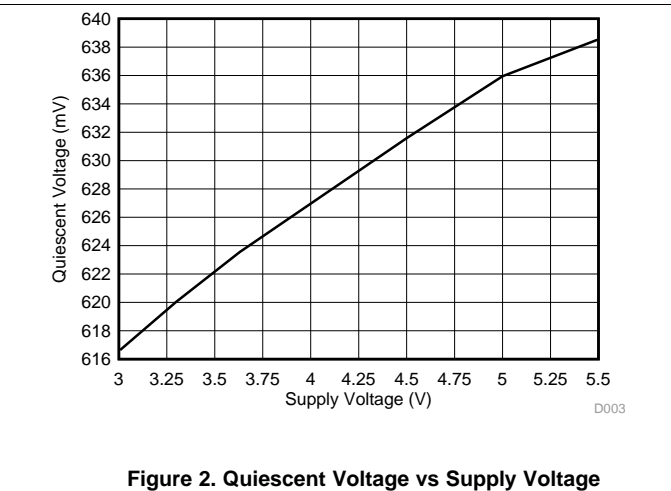

Figure 2. Quiescent Voltage vs Supply Voltage

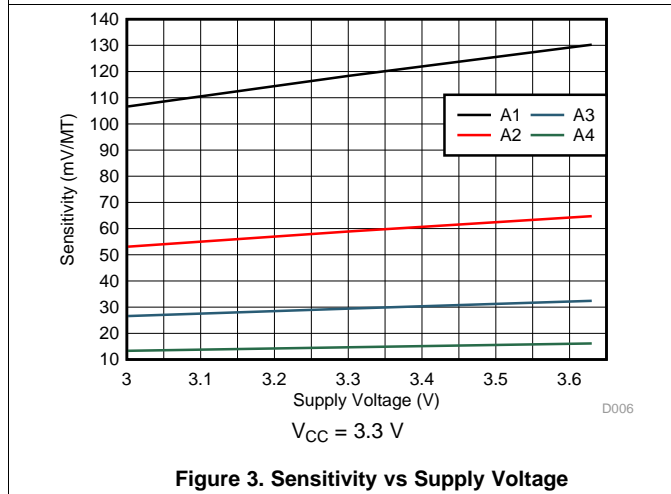

Figure 3. Sensitivity vs Supply Voltage

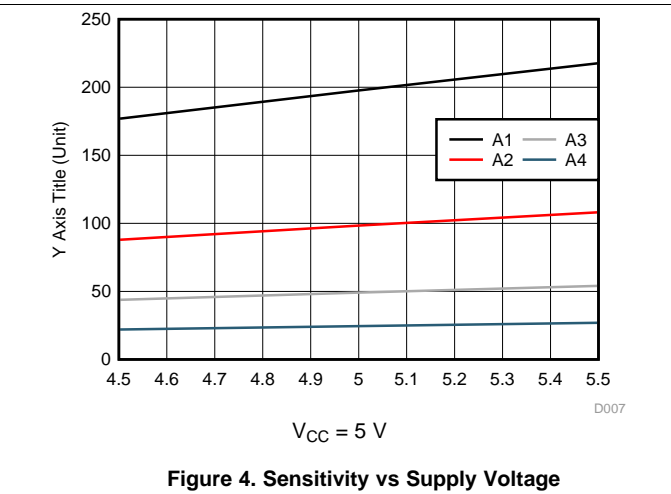

Figure 4. Sensitivity vs Supply Voltage

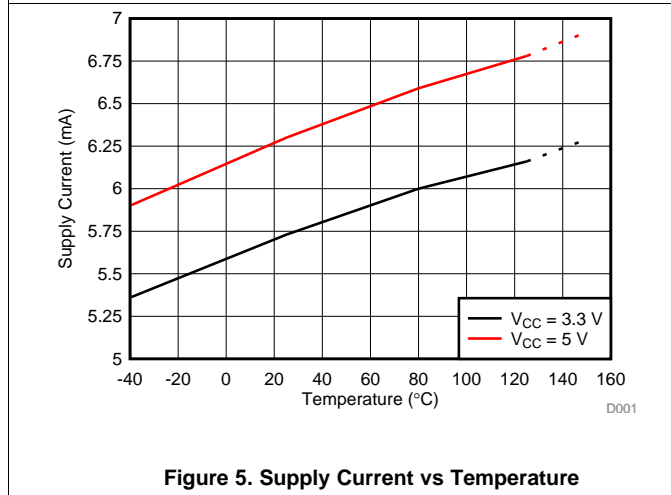

Figure 5. Supply Current vs Temperature

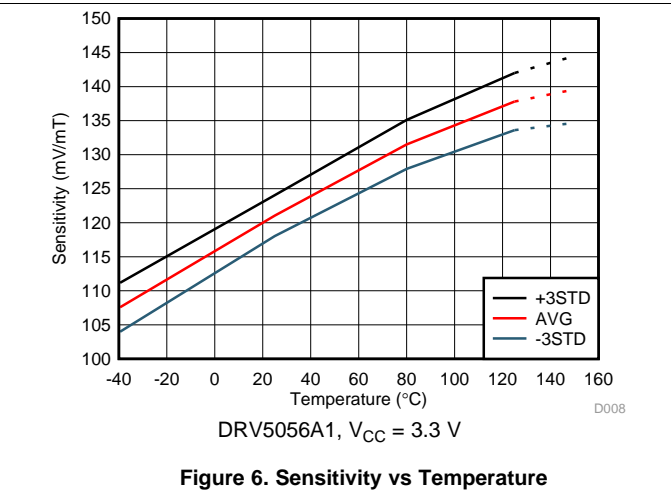
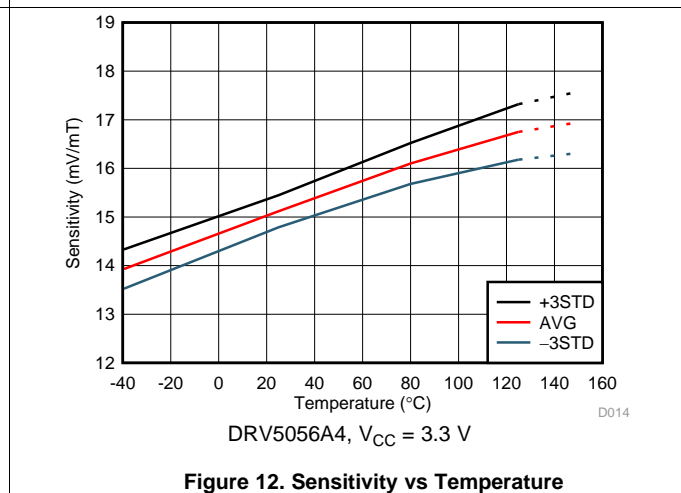
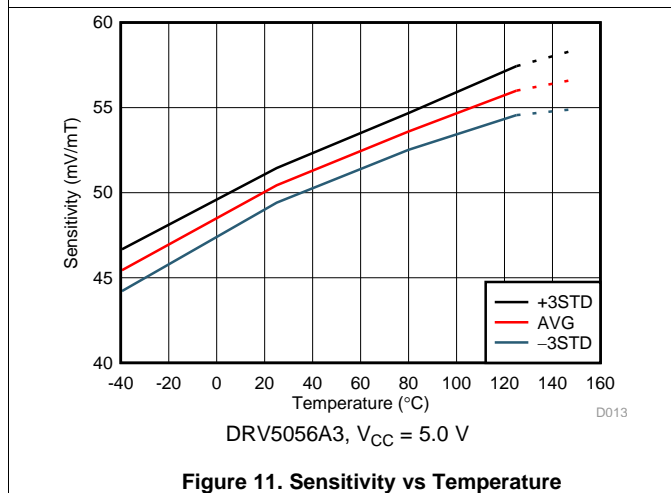
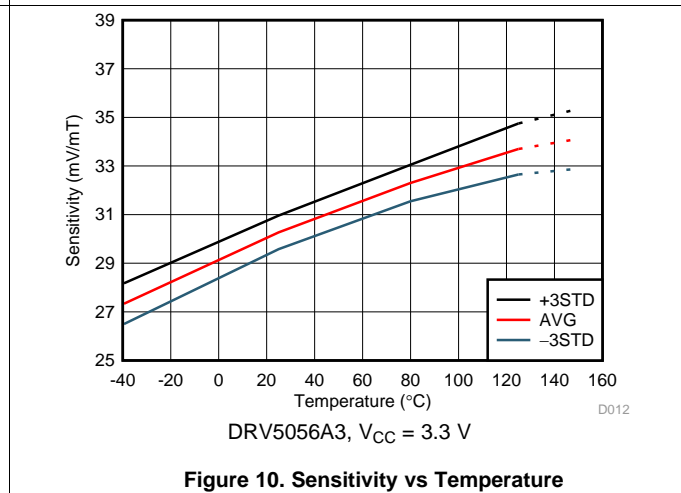
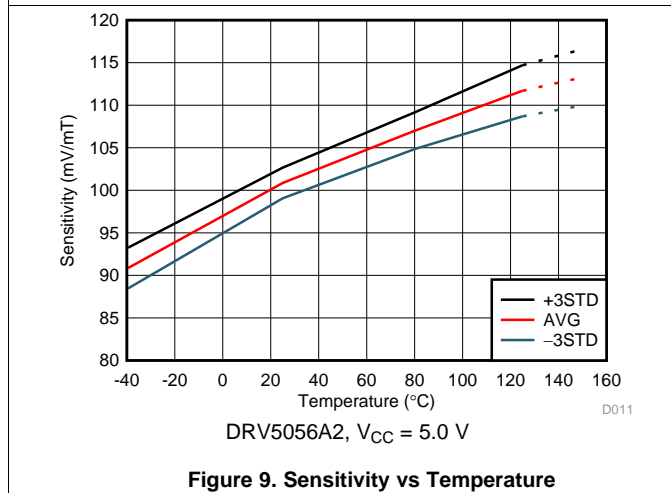
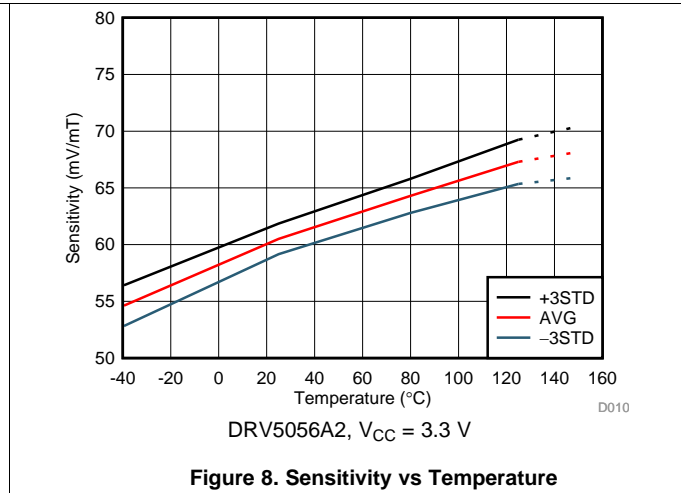
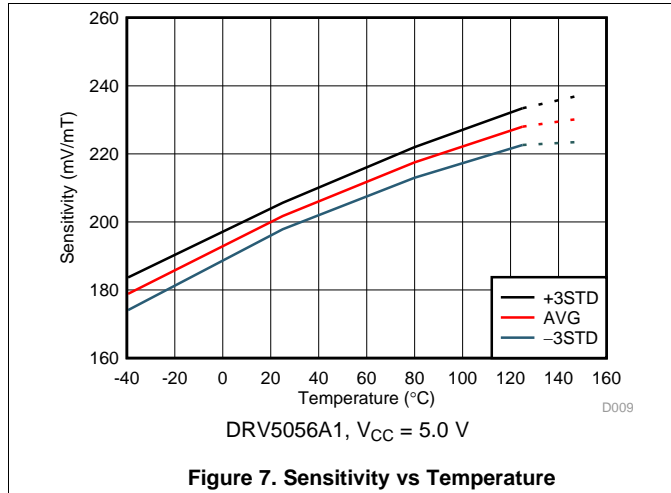

Figure 6. Sensitivity vs Temperature

Typical Characteristics (continued)

at  $T_A = 25^\circ\text{C}$  (unless otherwise noted)



**Typical Characteristics (continued)**

at  $T_A = 25^\circ\text{C}$  (unless otherwise noted)

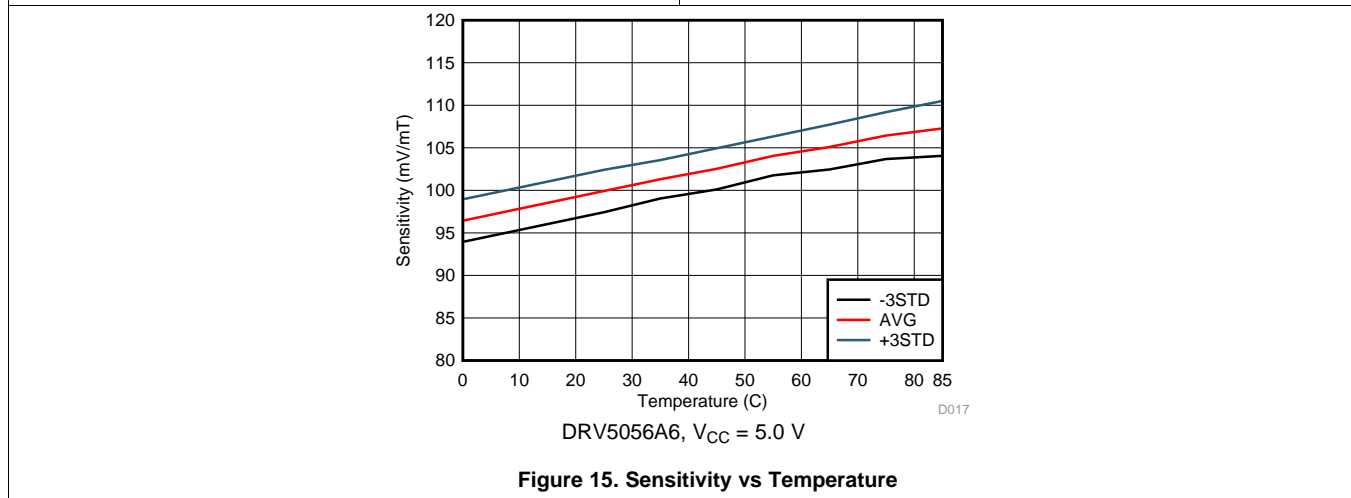
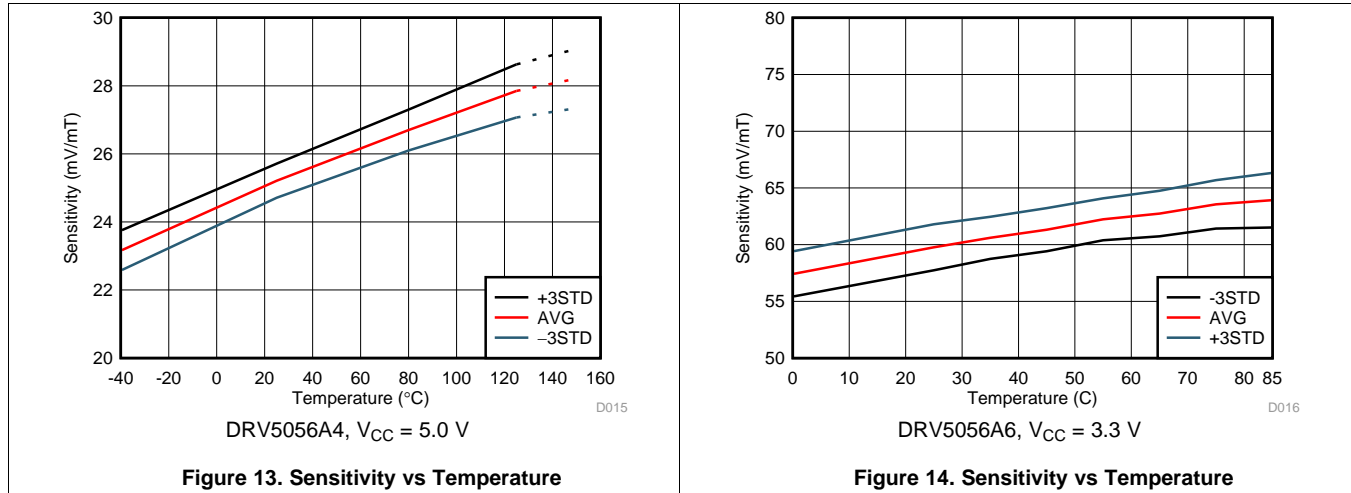



## 7 Detailed Description

### 7.1 Overview

The DRV5056 is a 3-pin linear Hall effect sensor with fully integrated signal conditioning, temperature compensation circuits, mechanical stress cancellation, and amplifiers. The device operates from 3.3-V and 5-V ( $\pm 10\%$ ) power supplies, measures magnetic flux density, and outputs a proportional analog voltage that is referenced to  $V_{CC}$ .

### 7.2 Functional Block Diagram

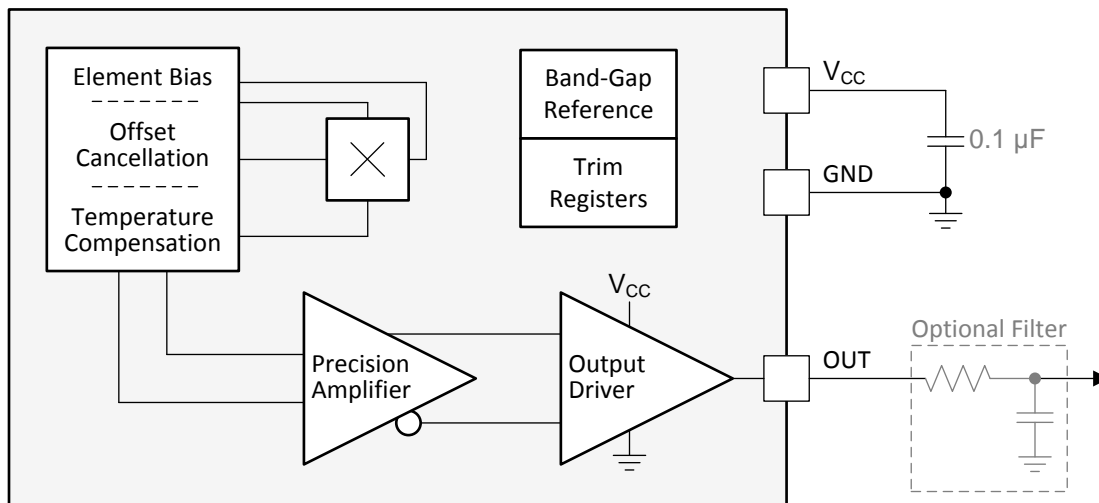

### 7.3 Feature Description

#### 7.3.1 Magnetic Flux Direction

As shown in Figure 16, the DRV5056 is sensitive to the magnetic field component that is perpendicular to the die inside the package.

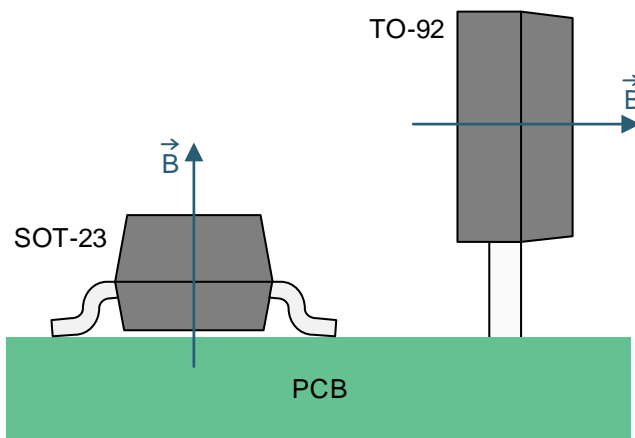
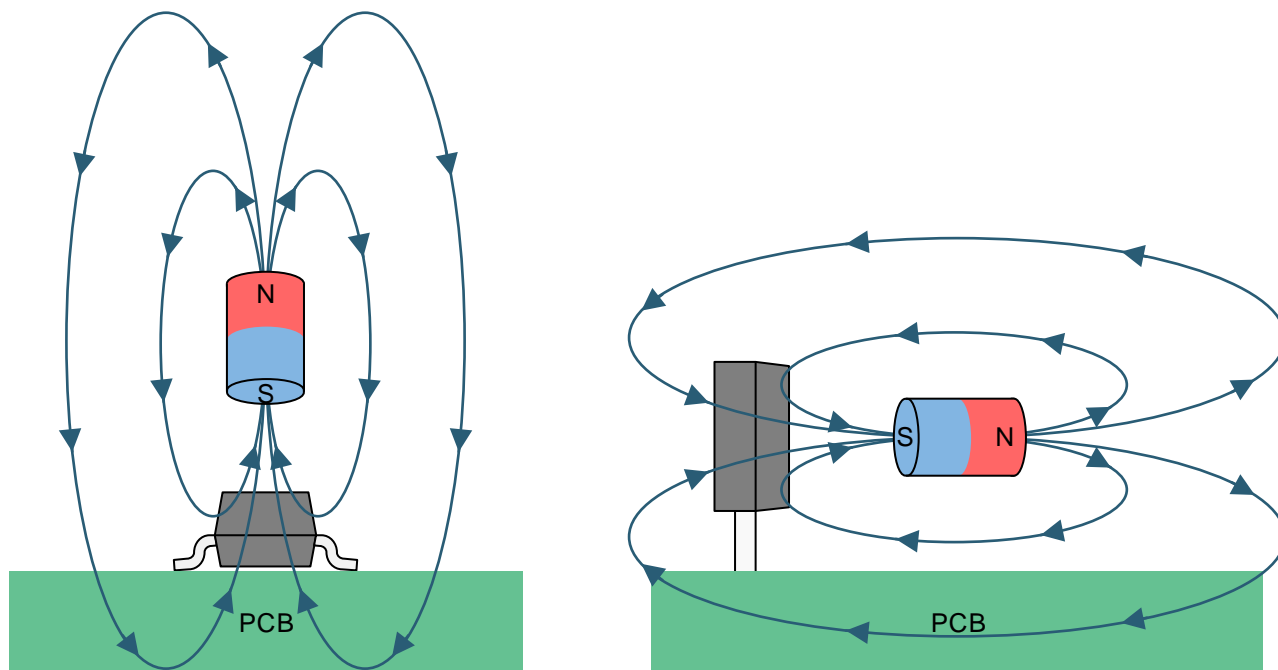

Figure 16. Direction of Sensitivity

## Feature Description (continued)

Magnetic flux that travels from the bottom to the top of the package is considered positive. This condition exists when a south magnetic pole is near the top (marked-side) of the package. Magnetic flux that travels from the top to the bottom of the package results in negative millitesla values.



**Figure 17. The Flux Direction for Positive B**

### 7.3.2 Magnetic Response

The DRV5056 outputs an analog voltage according to [Equation 1](#) when in the presence of a magnetic field:

$$V_{OUT} = V_Q + B \times (\text{Sensitivity}_{(25^\circ\text{C})} \times (1 + S_{TC} \times (T_A - 25^\circ\text{C})))$$

where

- $V_Q$  is typically 600 mV
- $B$  is the applied magnetic flux density
- $\text{Sensitivity}_{(25^\circ\text{C})}$  depends on the device option and  $V_{CC}$
- $S_{TC}$  is typically 0.12%/°C
- $T_A$  is the ambient temperature
- $V_{OUT}$  is within the  $V_L$  range

(1)

As an example, consider the DRV5056A3 with  $V_{CC} = 3.3$  V, a temperature of 50°C, and 67 mT applied. Excluding tolerances,  $V_{OUT} = 600$  mV + 67 mT × (30 mV/mT × [1 + 0.0012/°C × (50°C – 25°C)]) = 2.67 V.

The DRV5056 only responds to the flux density of a magnetic south pole.

## Feature Description (continued)

### 7.3.3 Sensitivity Linearity

The device produces a linear response when the output voltage is within the specified  $V_L$  range. Outside this range, sensitivity is reduced and nonlinear. Figure 18 graphs the magnetic response.

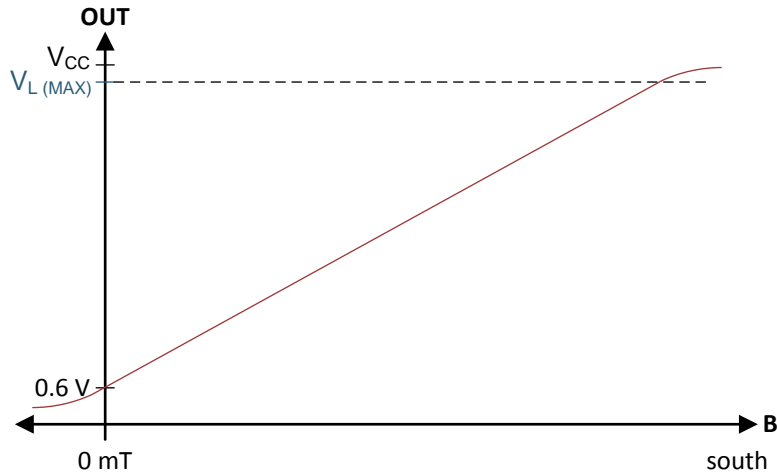

Figure 18. Magnetic Response

Equation 2 calculates parameter  $B_L$ , the minimum linear sensing range at 25°C taking into account the maximum quiescent voltage and sensitivity tolerances.

$$B_{L(MIN)} = \frac{V_{L(MAX)} - V_{Q(MAX)}}{S_{(MAX)}} \quad (2)$$

The parameter  $S_{LE}$  defines linearity error as the difference in sensitivity between any two positive  $B$  values when the output is within the  $V_L$  range.

### 7.3.4 Ratiometric Architecture

The DRV5056 has a ratiometric analog architecture that scales the sensitivity linearly with the power-supply voltage. For example, the sensitivity is 5% higher when  $V_{CC} = 5.25$  V compared to  $V_{CC} = 5$  V. This behavior enables external ADCs to digitize a more consistent value regardless of the power-supply voltage tolerance, when the ADC uses  $V_{CC}$  as its reference.

Equation 3 calculates sensitivity ratiometry error:

$$S_{RE} = 1 - \frac{S_{(VCC)} / S_{(5V)}}{V_{CC} / 5V} \quad \text{for } V_{CC} = 4.5 \text{ V to } 5.5 \text{ V}, \quad S_{RE} = 1 - \frac{S_{(VCC)} / S_{(3.3V)}}{V_{CC} / 3.3V} \quad \text{for } V_{CC} = 3 \text{ V to } 3.6 \text{ V}$$

where

- $S_{(VCC)}$  is the sensitivity at the current  $V_{CC}$  voltage
  - $S_{(5V)}$  or  $S_{(3.3V)}$  is the sensitivity when  $V_{CC} = 5$  V or 3.3 V
  - $V_{CC}$  is the current  $V_{CC}$  voltage
- (3)

## Feature Description (continued)

### 7.3.5 Operating $V_{CC}$ Ranges

The DRV5056 has two recommended operating  $V_{CC}$  ranges: 3 V to 3.6 V and 4.5 V to 5.5 V. When  $V_{CC}$  is in the middle region between 3.6 V to 4.5 V, the device continues to function, but sensitivity is less known because there is a crossover threshold near 4 V that adjusts device characteristics.

### 7.3.6 Sensitivity Temperature Compensation For Magnets

Magnets generally produce weaker fields as temperature increases. The DRV5056 compensates by increasing sensitivity with temperature, as defined by the parameter  $S_{TC}$ . The sensitivity at  $T_A = 125^\circ\text{C}$  is typically 12% higher than at  $T_A = 25^\circ\text{C}$ .

### 7.3.7 Power-On Time

After the  $V_{CC}$  voltage is applied, the DRV5056 requires a short initialization time before the output is set. The parameter  $t_{ON}$  describes the time from when  $V_{CC}$  crosses 3 V until OUT is within 5% of  $V_Q$ , with 0 mT applied and no load attached to OUT. [Figure 19](#) shows this timing diagram.

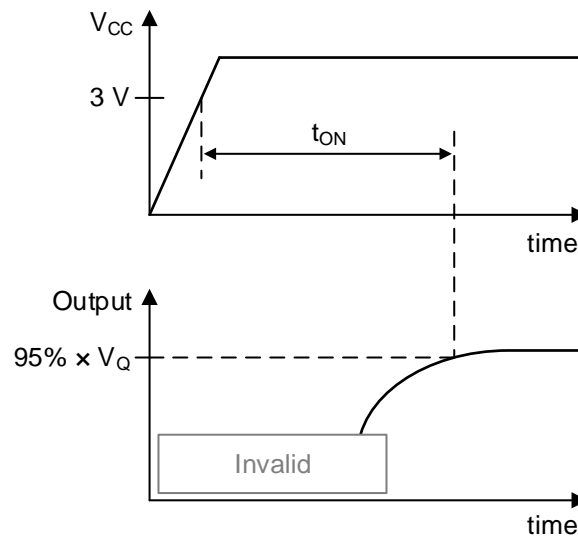

**Figure 19.  $t_{ON}$  Definition**

## Feature Description (continued)

### 7.3.8 Hall Element Location

Figure 20 shows the location of the sensing element inside each package option.

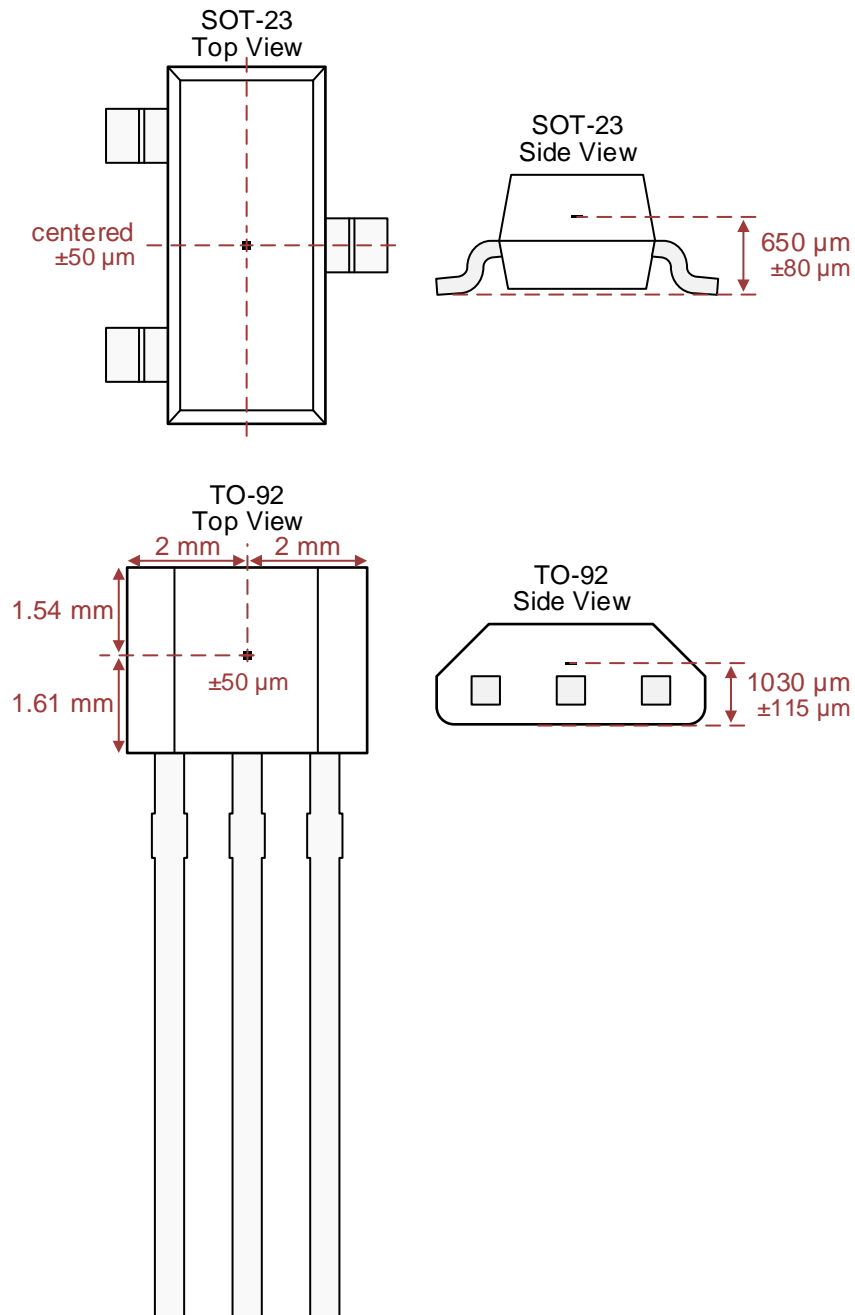

Figure 20. Hall Element Location

## 7.4 Device Functional Modes

The DRV5056 has one mode of operation that applies when the *Recommended Operating Conditions* are met.

## 8 Application and Implementation

### NOTE

Information in the following applications sections is not part of the TI component specification, and TI does not warrant its accuracy or completeness. TI's customers are responsible for determining suitability of components for their purposes. Customers should validate and test their design implementation to confirm system functionality.

### 8.1 Application Information

#### 8.1.1 Selecting the Sensitivity Option

Select the highest DRV5056 sensitivity option that can measure the required range of magnetic flux density, so that the output voltage swing is maximized.

Larger magnets and greater sensing distances can generally enable better positional accuracy than very small magnets at close distances, because magnetic flux density increases exponentially with the proximity to a magnet.

#### 8.1.2 Temperature Compensation for Magnets

The DRV5056 temperature compensation is designed to directly compensate the average drift of neodymium (NdFeB) magnets and partially compensate ferrite magnets. The residual flux density ( $B_r$ ) of a magnet typically reduces by 0.12%/°C for NdFeB, and 0.20%/°C for ferrite. When the operating temperature range of a system is reduced, temperature drift errors are also reduced.

#### 8.1.3 Adding a Low-Pass Filter

As illustrated in the [Functional Block Diagram](#), an RC low-pass filter can be added to the device output for the purpose of minimizing voltage noise when the full 20-kHz bandwidth is not needed. This filter can improve the signal-to-noise ratio (SNR) and overall accuracy. Do not connect a capacitor directly to the device output without a resistor in between because doing so can make the output unstable.

#### 8.1.4 Designing for Wire Break Detection

Some systems must detect if interconnect wires become open or shorted. The DRV5056 can support this function.

First, select a sensitivity option that causes the output voltage to stay within the  $V_L$  range during normal operation. Second, add a pullup resistor between OUT and  $V_{CC}$ . TI recommends a value between 20 k $\Omega$  to 100 k $\Omega$ , and the current through OUT must not exceed the  $I_O$  specification, including current going into an external ADC. Then, if the output voltage is ever measured to be within 150 mV of  $V_{CC}$  or GND, a fault condition exists. [Figure 21](#) shows the circuit, and [Table 1](#) describes fault scenarios.

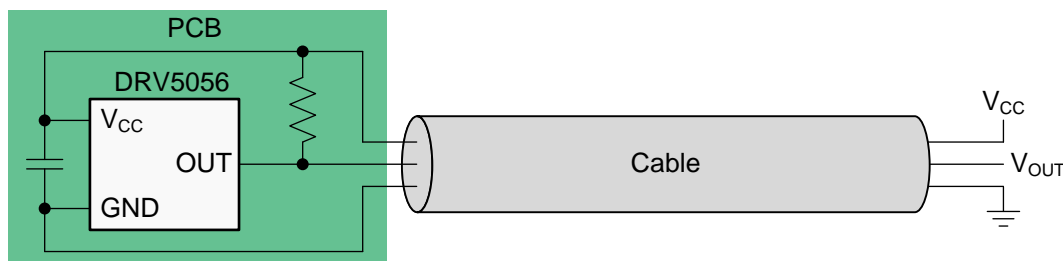
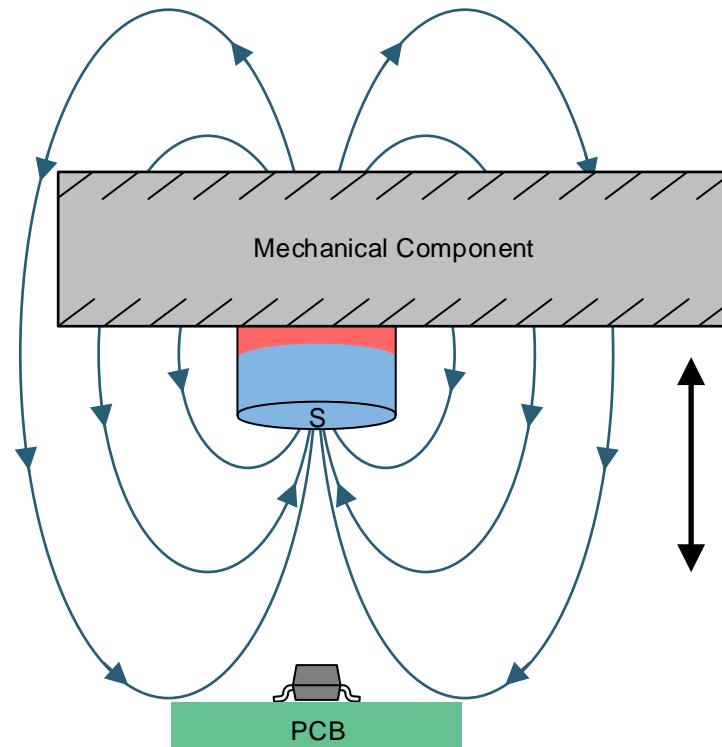

**Figure 21. Wire Fault Detection Circuit**

**Table 1. Fault Scenarios and the Resulting  $V_{OUT}$**

FAULT SCENARIO	$V_{OUT}$
$V_{CC}$ disconnects	Close to GND
GND disconnects	Close to $V_{CC}$
$V_{CC}$ shorts to OUT	Close to $V_{CC}$
GND shorts to OUT	Close to GND

## 8.2 Typical Application



**Figure 22. Unipolar Sensing Application**

### 8.2.1 Design Requirements

Use the parameters listed in [Table 2](#) for this design example.

**Table 2. Design Parameters**

DESIGN PARAMETER	EXAMPLE VALUE
$V_{CC}$	3.3 V
Magnet	10-mm diameter x 6-mm long cylinder, ferrite
Distance from magnet to sensor	From 20 mm to 3 mm
Maximum B at the sensor at 25°C	72 mT at 3 mm
Device option	DRV5056A3-Q1

### 8.2.2 Detailed Design Procedure

This design example consists of a mechanical component that moves back and forth, an embedded magnet with the south pole facing the printed-circuit board, and a DRV5056. The DRV5056 outputs an analog voltage that describes the precise position of the component. The component must not contain ferromagnetic materials such as iron, nickel, and cobalt because these materials change the magnetic flux density at the sensor.

When designing a linear magnetic sensing system, always consider these three variables: the magnet, sensing distance, and range of the sensor. Select the DRV5056 with the highest sensitivity that has a  $B_L$  (linear magnetic sensing range) that is larger than the maximum magnetic flux density in the application.

Magnets are made from various ferromagnetic materials that have tradeoffs in cost, drift with temperature, absolute maximum temperature ratings, remanence or residual induction ( $B_r$ ), and coercivity ( $H_c$ ). The  $B_r$  and the dimensions of a magnet determine the magnetic flux density ( $B$ ) produced in 3-dimensional space. For simple magnet shapes, such as rectangular blocks and cylinders, there are simple equations that solve  $B$  at a given distance centered with the magnet. [Figure 23](#) shows diagrams for [Equation 4](#) and [Equation 5](#).

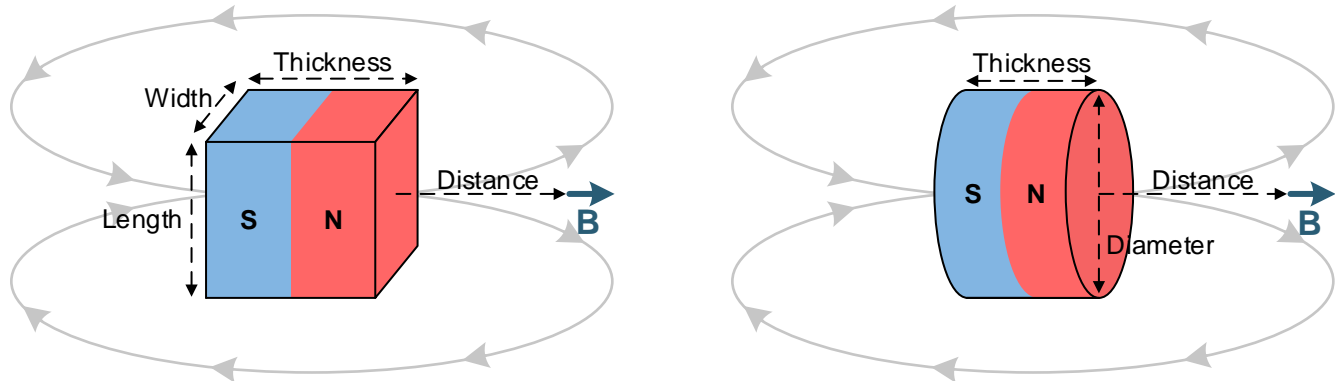

**Figure 23. Rectangular Block and Cylinder Magnets**

Use [Equation 4](#) for the rectangular block shown in [Figure 23](#):

$$\vec{B} = \frac{B_r}{\pi} \left( \arctan\left(\frac{WL}{2D\sqrt{4D^2 + W^2 + L^2}}\right) - \arctan\left(\frac{WL}{2(D+T)\sqrt{4(D+T)^2 + W^2 + L^2}}\right) \right) \quad (4)$$

Use [Equation 5](#) for the cylinder shown in [Figure 23](#):

$$\vec{B} = \frac{B_r}{2} \left( \frac{D+T}{\sqrt{(0.5C)^2 + (D+T)^2}} - \frac{D}{\sqrt{(0.5C)^2 + D^2}} \right)$$

where

- W is width
- L is length
- T is thickness (the direction of magnetization)
- D is distance
- C is diameter

(5)



### 8.2.3 Application Curve

Figure 24 shows the magnetic flux density versus distance for a 10-mm × 6-mm cylinder ferrite magnet.

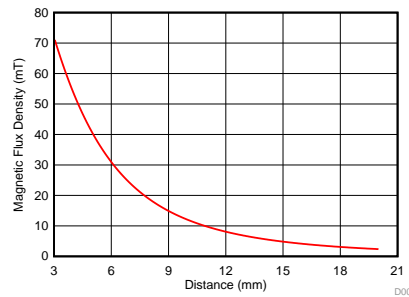

**Figure 24. Magnetic Profile of a 10-mm × 6-mm Cylindrical Ferrite Magnet**

### 8.3 What to Do and What Not to Do

Because the Hall element is sensitive to magnetic fields that are perpendicular to the top of the package, a correct magnet approach must be used for the sensor to detect the field. Figure 25 illustrates correct and incorrect approaches.

What to Do and What Not to Do (continued)

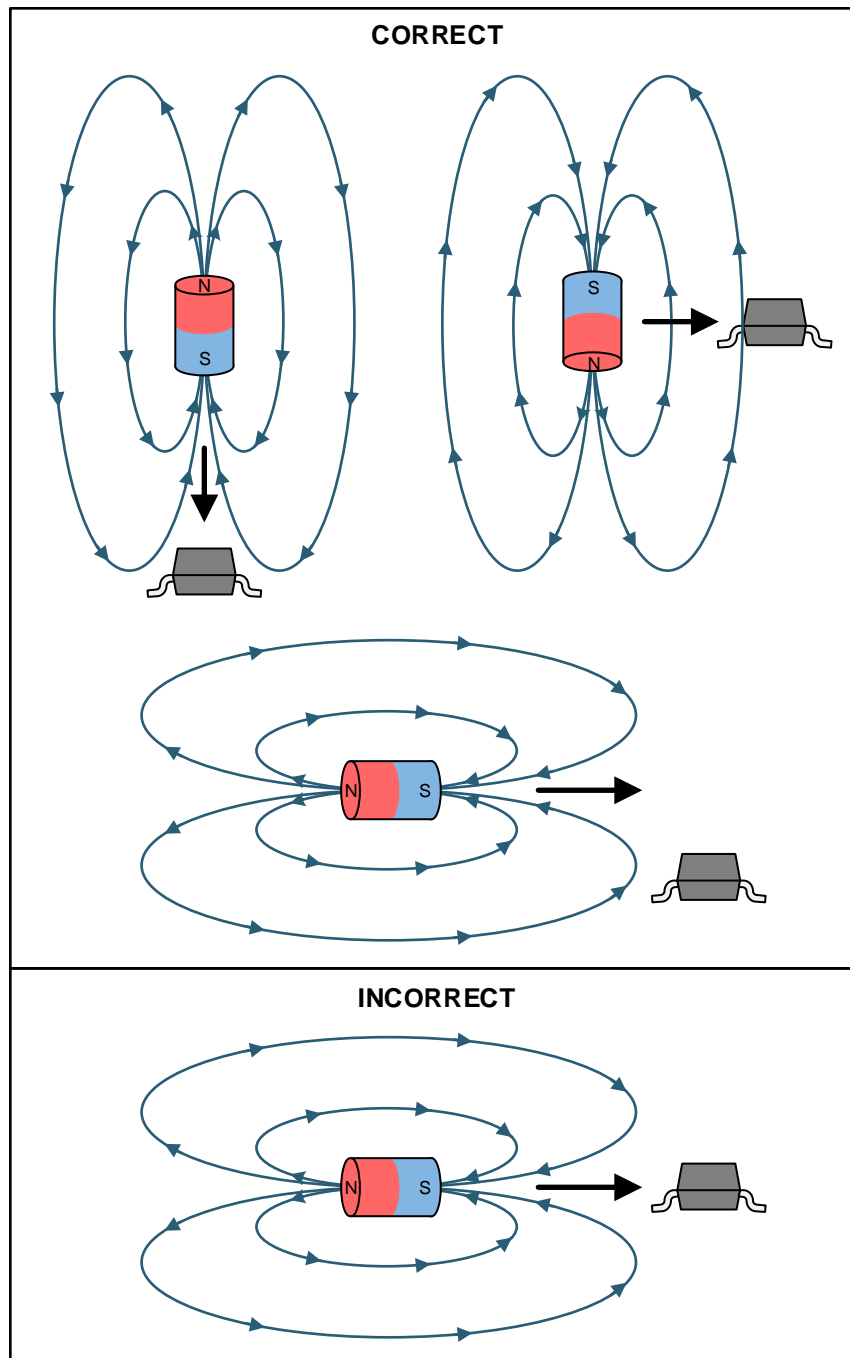

Figure 25. Correct and Incorrect Magnet Approaches

## 9 Power Supply Recommendations

A decoupling capacitor close to the device must be used to provide local energy with minimal inductance. TI recommends using a ceramic capacitor with a value of at least 0.01  $\mu\text{F}$ .

## 10 Layout

### 10.1 Layout Guidelines

Magnetic fields pass through most nonferromagnetic materials with no significant disturbance. Embedding Hall effect sensors within plastic or aluminum enclosures and sensing magnets on the outside is common practice. Magnetic fields also easily pass through most printed-circuit boards, which makes placing the magnet on the opposite side possible.

### 10.2 Layout Examples

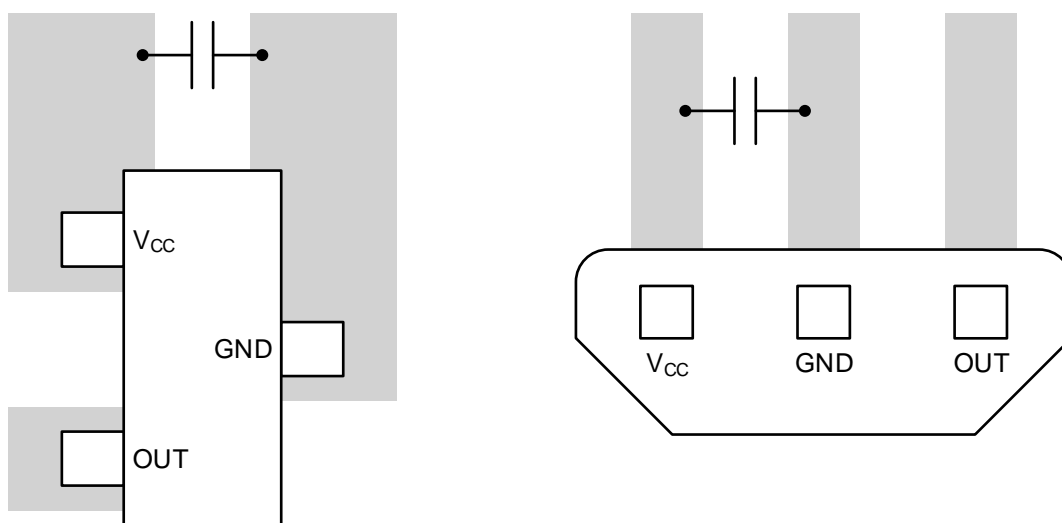

Figure 26. Layout Examples

## 11 Device and Documentation Support

### 11.1 Documentation Support

#### 11.1.1 Related Documentation

For related documentation see the following:

- Texas Instruments, [Incremental rotary encoder design considerations application note](#)
- Texas Instruments, [Using linear hall effect sensors to measure angle application note](#)
- Texas Instruments, [Angle measurements with linear hall effect sensors](#)

#### 11.2 Receiving Notification of Documentation Updates

To receive notification of documentation updates, navigate to the device product folder on ti.com. In the upper right corner, click on *Alert me* to register and receive a weekly digest of any product information that has changed. For change details, review the revision history included in any revised document.

#### 11.3 Community Resources

The following links connect to TI community resources. Linked contents are provided "AS IS" by the respective contributors. They do not constitute TI specifications and do not necessarily reflect TI's views; see TI's [Terms of Use](#).

**TI E2E™ Online Community** *TI's Engineer-to-Engineer (E2E) Community*. Created to foster collaboration among engineers. At e2e.ti.com, you can ask questions, share knowledge, explore ideas and help solve problems with fellow engineers.

**Design Support** *TI's Design Support* Quickly find helpful E2E forums along with design support tools and contact information for technical support.

#### 11.4 Trademarks

E2E is a trademark of Texas Instruments.  
All other trademarks are the property of their respective owners.

#### 11.5 Electrostatic Discharge Caution



This integrated circuit can be damaged by ESD. Texas Instruments recommends that all integrated circuits be handled with appropriate precautions. Failure to observe proper handling and installation procedures can cause damage.

ESD damage can range from subtle performance degradation to complete device failure. Precision integrated circuits may be more susceptible to damage because very small parametric changes could cause the device not to meet its published specifications.

#### 11.6 Glossary

**SLYZ022** — *TI Glossary*.

This glossary lists and explains terms, acronyms, and definitions.

## 12 Mechanical, Packaging, and Orderable Information

The following pages include mechanical, packaging, and orderable information. This information is the most current data available for the designated devices. This data is subject to change without notice and revision of this document. For browser-based versions of this data sheet, refer to the left-hand navigation.

**PACKAGING INFORMATION**

Orderable Device	Status (1)	Package Type	Package Drawing	Pins	Package Qty	Eco Plan (2)	Lead/Ball Finish (6)	MSL Peak Temp (3)	Op Temp (°C)	Device Marking (4/5)	Samples
DRV5056A1QDBZR	ACTIVE	SOT-23	DBZ	3	3000	Green (RoHS & no Sb/Br)	CU SN	Level-2-260C-1 YEAR	-40 to 125	56A1	<a href="#">Samples</a>
DRV5056A1QDBZT	ACTIVE	SOT-23	DBZ	3	250	Green (RoHS & no Sb/Br)	CU SN	Level-2-260C-1 YEAR	-40 to 125	56A1	<a href="#">Samples</a>
DRV5056A1QLPG	ACTIVE	TO-92	LPG	3	1000	Green (RoHS & no Sb/Br)	CU SN	N / A for Pkg Type	-40 to 125	56A1	<a href="#">Samples</a>
DRV5056A1QLPGM	ACTIVE	TO-92	LPG	3	3000	Green (RoHS & no Sb/Br)	CU SN	N / A for Pkg Type	-40 to 125	56A1	<a href="#">Samples</a>
DRV5056A2QDBZR	ACTIVE	SOT-23	DBZ	3	3000	Green (RoHS & no Sb/Br)	CU SN	Level-2-260C-1 YEAR	-40 to 125	56A2	<a href="#">Samples</a>
DRV5056A2QDBZT	ACTIVE	SOT-23	DBZ	3	250	Green (RoHS & no Sb/Br)	CU SN	Level-2-260C-1 YEAR	-40 to 125	56A2	<a href="#">Samples</a>
DRV5056A2QLPG	ACTIVE	TO-92	LPG	3	1000	Green (RoHS & no Sb/Br)	CU SN	N / A for Pkg Type	-40 to 125	56A2	<a href="#">Samples</a>
DRV5056A2QLPGM	ACTIVE	TO-92	LPG	3	3000	Green (RoHS & no Sb/Br)	CU SN	N / A for Pkg Type	-40 to 125	56A2	<a href="#">Samples</a>
DRV5056A3QDBZR	ACTIVE	SOT-23	DBZ	3	3000	Green (RoHS & no Sb/Br)	CU SN	Level-2-260C-1 YEAR	-40 to 125	56A3	<a href="#">Samples</a>
DRV5056A3QDBZT	ACTIVE	SOT-23	DBZ	3	250	Green (RoHS & no Sb/Br)	CU SN	Level-2-260C-1 YEAR	-40 to 125	56A3	<a href="#">Samples</a>
DRV5056A3QLPG	ACTIVE	TO-92	LPG	3	1000	Green (RoHS & no Sb/Br)	CU SN	N / A for Pkg Type	-40 to 125	56A3	<a href="#">Samples</a>
DRV5056A3QLPGM	ACTIVE	TO-92	LPG	3	3000	Green (RoHS & no Sb/Br)	CU SN	N / A for Pkg Type	-40 to 125	56A3	<a href="#">Samples</a>
DRV5056A4QDBZR	ACTIVE	SOT-23	DBZ	3	3000	Green (RoHS & no Sb/Br)	CU SN	Level-2-260C-1 YEAR	-40 to 125	56A4	<a href="#">Samples</a>
DRV5056A4QDBZT	ACTIVE	SOT-23	DBZ	3	250	Green (RoHS & no Sb/Br)	CU SN	Level-2-260C-1 YEAR	-40 to 125	56A4	<a href="#">Samples</a>
DRV5056A4QLPG	ACTIVE	TO-92	LPG	3	1000	Green (RoHS & no Sb/Br)	CU SN	N / A for Pkg Type	-40 to 125	56A4	<a href="#">Samples</a>
DRV5056A4QLPGM	ACTIVE	TO-92	LPG	3	3000	Green (RoHS & no Sb/Br)	CU SN	N / A for Pkg Type	-40 to 125	56A4	<a href="#">Samples</a>
DRV5056A6QDBZR	ACTIVE	SOT-23	DBZ	3	3000	Green (RoHS & no Sb/Br)	CU SN	Level-2-260C-1 YEAR	-40 to 125	56A6	<a href="#">Samples</a>

Orderable Device	Status (1)	Package Type	Package Drawing	Pins	Package Qty	Eco Plan (2)	Lead/Ball Finish (6)	MSL Peak Temp (3)	Op Temp (°C)	Device Marking (4/5)	Samples
DRV5056A6QDBZT	ACTIVE	SOT-23	DBZ	3	250	Green (RoHS & no Sb/Br)	CU SN	Level-2-260C-1 YEAR	-40 to 125	56A6	<b>Samples</b>

(1) The marketing status values are defined as follows:

**ACTIVE:** Product device recommended for new designs.

**LIFEBUY:** TI has announced that the device will be discontinued, and a lifetime-buy period is in effect.

**NRND:** Not recommended for new designs. Device is in production to support existing customers, but TI does not recommend using this part in a new design.

**PREVIEW:** Device has been announced but is not in production. Samples may or may not be available.

**OBSOLETE:** TI has discontinued the production of the device.

(2) **RoHS:** TI defines "RoHS" to mean semiconductor products that are compliant with the current EU RoHS requirements for all 10 RoHS substances, including the requirement that RoHS substance do not exceed 0.1% by weight in homogeneous materials. Where designed to be soldered at high temperatures, "RoHS" products are suitable for use in specified lead-free processes. TI may reference these types of products as "Pb-Free".

**RoHS Exempt:** TI defines "RoHS Exempt" to mean products that contain lead but are compliant with EU RoHS pursuant to a specific EU RoHS exemption.

**Green:** TI defines "Green" to mean the content of Chlorine (Cl) and Bromine (Br) based flame retardants meet JS709B low halogen requirements of <=1000ppm threshold. Antimony trioxide based flame retardants must also meet the <=1000ppm threshold requirement.

(3) MSL, Peak Temp. - The Moisture Sensitivity Level rating according to the JEDEC industry standard classifications, and peak solder temperature.

(4) There may be additional marking, which relates to the logo, the lot trace code information, or the environmental category on the device.

(5) Multiple Device Markings will be inside parentheses. Only one Device Marking contained in parentheses and separated by a "~" will appear on a device. If a line is indented then it is a continuation of the previous line and the two combined represent the entire Device Marking for that device.

(6) Lead/Ball Finish - Orderable Devices may have multiple material finish options. Finish options are separated by a vertical ruled line. Lead/Ball Finish values may wrap to two lines if the finish value exceeds the maximum column width.

**Important Information and Disclaimer:** The information provided on this page represents TI's knowledge and belief as of the date that it is provided. TI bases its knowledge and belief on information provided by third parties, and makes no representation or warranty as to the accuracy of such information. Efforts are underway to better integrate information from third parties. TI has taken and continues to take reasonable steps to provide representative and accurate information but may not have conducted destructive testing or chemical analysis on incoming materials and chemicals. TI and TI suppliers consider certain information to be proprietary, and thus CAS numbers and other limited information may not be available for release.

In no event shall TI's liability arising out of such information exceed the total purchase price of the TI part(s) at issue in this document sold by TI to Customer on an annual basis.

#### OTHER QUALIFIED VERSIONS OF DRV5056 :

- Automotive: [DRV5056-Q1](#)

NOTE: Qualified Version Definitions:

- Automotive - Q100 devices qualified for high-reliability automotive applications targeting zero defects

## TAPE AND REEL INFORMATION



### QUADRANT ASSIGNMENTS FOR PIN 1 ORIENTATION IN TAPE



\*All dimensions are nominal

Device	Package Type	Package Drawing	Pins	SPQ	Reel Diameter (mm)	Reel Width W1 (mm)	A0 (mm)	B0 (mm)	K0 (mm)	P1 (mm)	W (mm)	Pin1 Quadrant
DRV5056A1QDBZR	SOT-23	DBZ	3	3000	180.0	8.4	3.15	2.77	1.22	4.0	8.0	Q3
DRV5056A1QDBZT	SOT-23	DBZ	3	250	180.0	8.4	3.15	2.77	1.22	4.0	8.0	Q3
DRV5056A2QDBZR	SOT-23	DBZ	3	3000	180.0	8.4	3.15	2.77	1.22	4.0	8.0	Q3
DRV5056A2QDBZT	SOT-23	DBZ	3	250	180.0	8.4	3.15	2.77	1.22	4.0	8.0	Q3
DRV5056A3QDBZR	SOT-23	DBZ	3	3000	180.0	8.4	3.15	2.77	1.22	4.0	8.0	Q3
DRV5056A3QDBZT	SOT-23	DBZ	3	250	180.0	8.4	3.15	2.77	1.22	4.0	8.0	Q3
DRV5056A4QDBZR	SOT-23	DBZ	3	3000	180.0	8.4	3.15	2.77	1.22	4.0	8.0	Q3
DRV5056A4QDBZT	SOT-23	DBZ	3	250	180.0	8.4	3.15	2.77	1.22	4.0	8.0	Q3
DRV5056A6QDBZR	SOT-23	DBZ	3	3000	180.0	8.4	3.15	2.77	1.22	4.0	8.0	Q3
DRV5056A6QDBZT	SOT-23	DBZ	3	250	180.0	8.4	3.15	2.77	1.22	4.0	8.0	Q3



**TAPE AND REEL BOX DIMENSIONS**

\*All dimensions are nominal

Device	Package Type	Package Drawing	Pins	SPQ	Length (mm)	Width (mm)	Height (mm)
DRV5056A1QDBZR	SOT-23	DBZ	3	3000	213.0	191.0	35.0
DRV5056A1QDBZT	SOT-23	DBZ	3	250	213.0	191.0	35.0
DRV5056A2QDBZR	SOT-23	DBZ	3	3000	213.0	191.0	35.0
DRV5056A2QDBZT	SOT-23	DBZ	3	250	213.0	191.0	35.0
DRV5056A3QDBZR	SOT-23	DBZ	3	3000	213.0	191.0	35.0
DRV5056A3QDBZT	SOT-23	DBZ	3	250	213.0	191.0	35.0
DRV5056A4QDBZR	SOT-23	DBZ	3	3000	213.0	191.0	35.0
DRV5056A4QDBZT	SOT-23	DBZ	3	250	213.0	191.0	35.0
DRV5056A6QDBZR	SOT-23	DBZ	3	3000	213.0	191.0	35.0
DRV5056A6QDBZT	SOT-23	DBZ	3	250	213.0	191.0	35.0

# LPG0003A



# PACKAGE OUTLINE

## TO-92 - 5.05 mm max height

TRANSISTOR OUTLINE

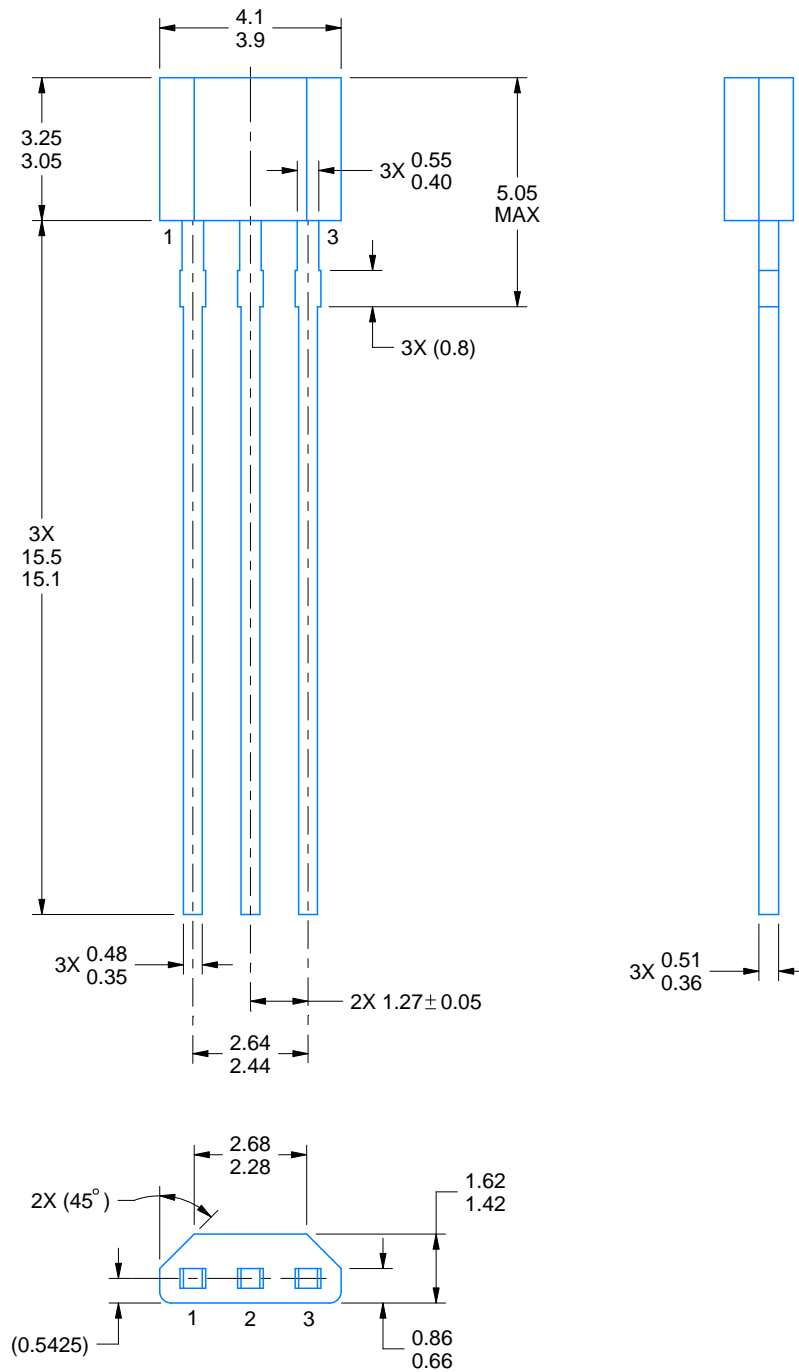

4221343/C 01/2018

### NOTES:

1. All linear dimensions are in millimeters. Any dimensions in parenthesis are for reference only. Dimensioning and tolerancing per ASME Y14.5M.
2. This drawing is subject to change without notice.

# EXAMPLE BOARD LAYOUT

LPG0003A

TO-92 - 5.05 mm max height

TRANSISTOR OUTLINE

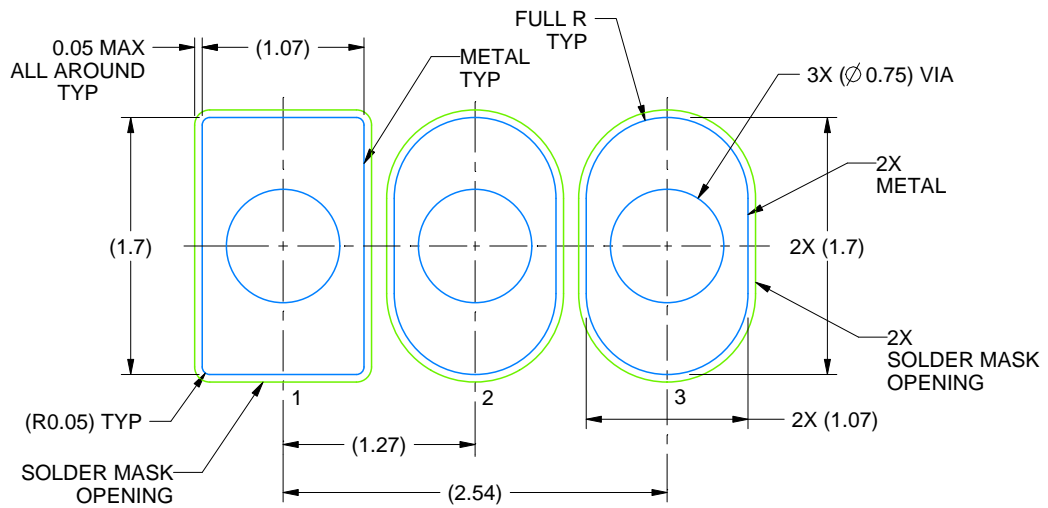

LAND PATTERN EXAMPLE  
NON-SOLDER MASK DEFINED  
SCALE:20X

4221343/C 01/2018

# TAPE SPECIFICATIONS

LPG0003A

TO-92 - 5.05 mm max height

TRANSISTOR OUTLINE



## GENERIC PACKAGE VIEW

**DBZ 3**

**SOT-23 - 1.12 mm max height**

SMALL OUTLINE TRANSISTOR



Images above are just a representation of the package family, actual package may vary.  
Refer to the product data sheet for package details.

4203227/C

DBZ0003A



# PACKAGE OUTLINE

SOT-23 - 1.12 mm max height

SMALL OUTLINE TRANSISTOR

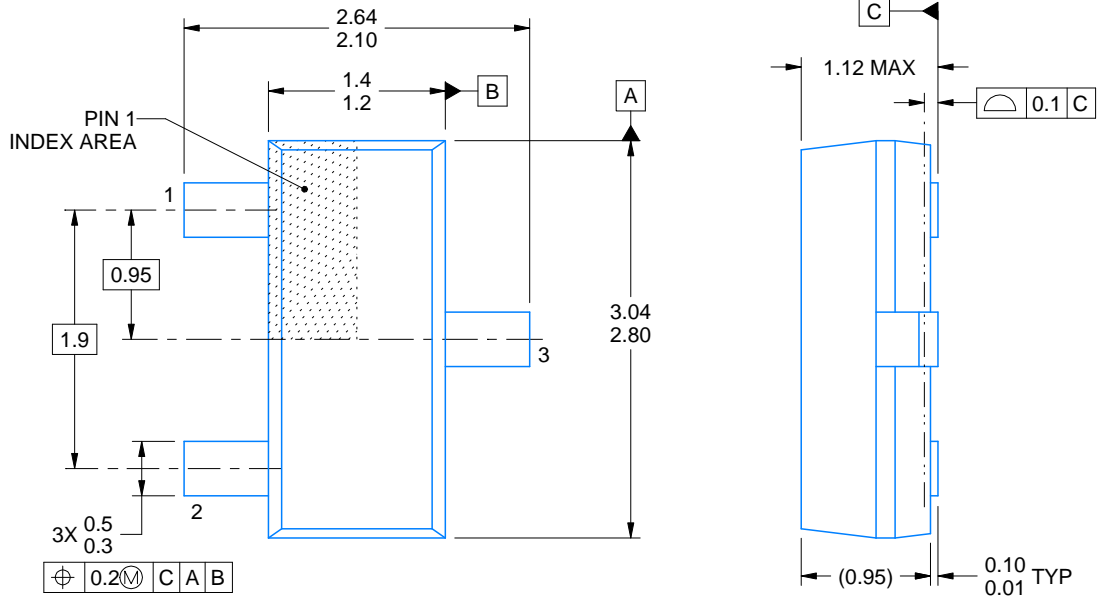

4214838/C 04/2017

## NOTES:

1. All linear dimensions are in millimeters. Any dimensions in parenthesis are for reference only. Dimensioning and tolerancing per ASME Y14.5M.
2. This drawing is subject to change without notice.
3. Reference JEDEC registration TO-236, except minimum foot length.

# EXAMPLE BOARD LAYOUT

DBZ0003A

SOT-23 - 1.12 mm max height

SMALL OUTLINE TRANSISTOR



LAND PATTERN EXAMPLE  
SCALE:15X

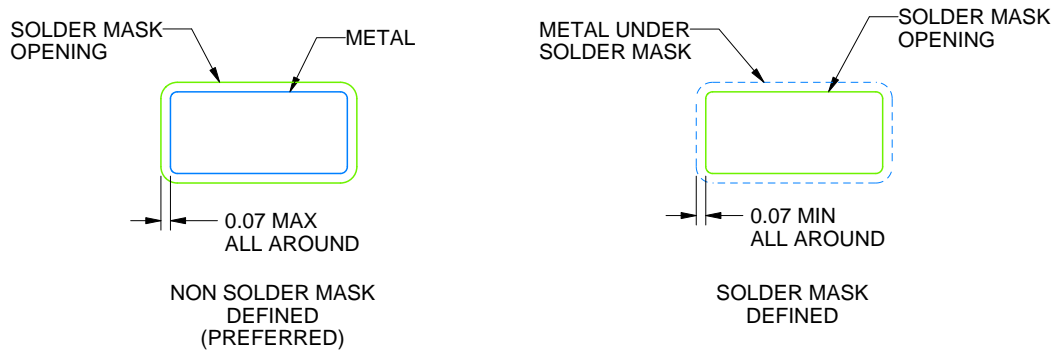

SOLDER MASK DETAILS

4214838/C 04/2017

NOTES: (continued)

- 4. Publication IPC-7351 may have alternate designs.
- 5. Solder mask tolerances between and around signal pads can vary based on board fabrication site.

# EXAMPLE STENCIL DESIGN

DBZ0003A

SOT-23 - 1.12 mm max height

SMALL OUTLINE TRANSISTOR



SOLDER PASTE EXAMPLE  
BASED ON 0.125 THICK STENCIL  
SCALE:15X

4214838/C 04/2017

NOTES: (continued)

6. Laser cutting apertures with trapezoidal walls and rounded corners may offer better paste release. IPC-7525 may have alternate design recommendations.
7. Board assembly site may have different recommendations for stencil design.



## IMPORTANT NOTICE AND DISCLAIMER

TI PROVIDES TECHNICAL AND RELIABILITY DATA (INCLUDING DATASHEETS), DESIGN RESOURCES (INCLUDING REFERENCE DESIGNS), APPLICATION OR OTHER DESIGN ADVICE, WEB TOOLS, SAFETY INFORMATION, AND OTHER RESOURCES "AS IS" AND WITH ALL FAULTS, AND DISCLAIMS ALL WARRANTIES, EXPRESS AND IMPLIED, INCLUDING WITHOUT LIMITATION ANY IMPLIED WARRANTIES OF MERCHANTABILITY, FITNESS FOR A PARTICULAR PURPOSE OR NON-INFRINGEMENT OF THIRD PARTY INTELLECTUAL PROPERTY RIGHTS.

These resources are intended for skilled developers designing with TI products. You are solely responsible for (1) selecting the appropriate TI products for your application, (2) designing, validating and testing your application, and (3) ensuring your application meets applicable standards, and any other safety, security, or other requirements. These resources are subject to change without notice. TI grants you permission to use these resources only for development of an application that uses the TI products described in the resource. Other reproduction and display of these resources is prohibited. No license is granted to any other TI intellectual property right or to any third party intellectual property right. TI disclaims responsibility for, and you will fully indemnify TI and its representatives against, any claims, damages, costs, losses, and liabilities arising out of your use of these resources.

TI's products are provided subject to TI's Terms of Sale ([www.ti.com/legal/termsofsale.html](http://www.ti.com/legal/termsofsale.html)) or other applicable terms available either on [ti.com](http://ti.com) or provided in conjunction with such TI products. TI's provision of these resources does not expand or otherwise alter TI's applicable warranties or warranty disclaimers for TI products.

Mailing Address: Texas Instruments, Post Office Box 655303, Dallas, Texas 75265  
Copyright © 2019, Texas Instruments Incorporated