

To our customers,

---

## Old Company Name in Catalogs and Other Documents

---

On April 1<sup>st</sup>, 2010, NEC Electronics Corporation merged with Renesas Technology Corporation, and Renesas Electronics Corporation took over all the business of both companies. Therefore, although the old company name remains in this document, it is a valid Renesas Electronics document. We appreciate your understanding.

Renesas Electronics website: <http://www.renesas.com>

April 1<sup>st</sup>, 2010  
Renesas Electronics Corporation

Issued by: Renesas Electronics Corporation (<http://www.renesas.com>)

Send any inquiries to <http://www.renesas.com/inquiry>.

Not recommended  
for new design

## Notice

1. All information included in this document is current as of the date this document is issued. Such information, however, is subject to change without any prior notice. Before purchasing or using any Renesas Electronics products listed herein, please confirm the latest product information with a Renesas Electronics sales office. Also, please pay regular and careful attention to additional and different information to be disclosed by Renesas Electronics such as that disclosed through our website.
2. Renesas Electronics does not assume any liability for infringement of patents, copyrights, or other intellectual property rights of third parties by or arising from the use of Renesas Electronics products or technical information described in this document. No license, express, implied or otherwise, is granted hereby under any patents, copyrights or other intellectual property rights of Renesas Electronics or others.
3. You should not alter, modify, copy, or otherwise misappropriate any Renesas Electronics product, whether in whole or in part.
4. Descriptions of circuits, software and other related information in this document are provided only to illustrate the operation of semiconductor products and application examples. You are fully responsible for the incorporation of these circuits, software, and information in the design of your equipment. Renesas Electronics assumes no responsibility for any losses incurred by you or third parties arising from the use of these circuits, software, or information.
5. When exporting the products or technology described in this document, you should comply with the applicable export control laws and regulations and follow the procedures required by such laws and regulations. You should not use Renesas Electronics products or the technology described in this document for any purpose relating to military applications or use by the military, including but not limited to the development of weapons of mass destruction. Renesas Electronics products and technology may not be used for or incorporated into any products or systems whose manufacture, use, or sale is prohibited under any applicable domestic or foreign laws or regulations.
6. Renesas Electronics has used reasonable care in preparing the information included in this document, but Renesas Electronics does not warrant that such information is error free. Renesas Electronics assumes no liability whatsoever for any damages incurred by you resulting from errors in or omissions from the information included herein.
7. Renesas Electronics products are classified according to the following three quality grades: “Standard”, “High Quality”, and “Specific”. The recommended applications for each Renesas Electronics product depends on the product’s quality grade, as indicated below. You must check the quality grade of each Renesas Electronics product before using it in a particular application. You may not use any Renesas Electronics product for any application categorized as “Specific” without the prior written consent of Renesas Electronics. Further, you may not use any Renesas Electronics product for any application for which it is not intended without the prior written consent of Renesas Electronics. Renesas Electronics shall not be in any way liable for any damages or losses incurred by you or third parties arising from the use of any Renesas Electronics product for an application categorized as “Specific” or for which the product is not intended where you have failed to obtain the prior written consent of Renesas Electronics. The quality grade of each Renesas Electronics product is “Standard” unless otherwise expressly specified in a Renesas Electronics data sheets or data books, etc.
  - “Standard”: Computers; office equipment; communications equipment; test and measurement equipment; audio and visual equipment; home electronic appliances; machine tools; personal electronic equipment; and industrial robots.
  - “High Quality”: Transportation equipment (automobiles, trains, ships, etc.); traffic control systems; anti-disaster systems; anti-crime systems; safety equipment; and medical equipment not specifically designed for life support.
  - “Specific”: Aircraft; aerospace equipment; submersible repeaters; nuclear reactor control systems; medical equipment or systems for life support (e.g. artificial life support devices or systems), surgical implantations, or healthcare intervention (e.g. excision, etc.), and any other applications or purposes that pose a direct threat to human life.
8. You should use the Renesas Electronics products described in this document within the range specified by Renesas Electronics, especially with respect to the maximum rating, operating supply voltage range, movement power voltage range, heat radiation characteristics, installation and other product characteristics. Renesas Electronics shall have no liability for malfunctions or damages arising out of the use of Renesas Electronics products beyond such specified ranges.
9. Although Renesas Electronics endeavors to improve the quality and reliability of its products, semiconductor products have specific characteristics such as the occurrence of failure at a certain rate and malfunctions under certain use conditions. Further, Renesas Electronics products are not subject to radiation resistance design. Please be sure to implement safety measures to guard them against the possibility of physical injury, and injury or damage caused by fire in the event of the failure of a Renesas Electronics product, such as safety design for hardware and software including but not limited to redundancy, fire control and malfunction prevention, appropriate treatment for aging degradation or any other appropriate measures. Because the evaluation of microcomputer software alone is very difficult, please evaluate the safety of the final products or system manufactured by you.
10. Please contact a Renesas Electronics sales office for details as to environmental matters such as the environmental compatibility of each Renesas Electronics product. Please use Renesas Electronics products in compliance with all applicable laws and regulations that regulate the inclusion or use of controlled substances, including without limitation, the EU RoHS Directive. Renesas Electronics assumes no liability for damages or losses occurring as a result of your noncompliance with applicable laws and regulations.
11. This document may not be reproduced or duplicated, in any form, in whole or in part, without prior written consent of Renesas Electronics.
12. Please contact a Renesas Electronics sales office if you have any questions regarding the information contained in this document or Renesas Electronics products, or if you have any other inquiries.

(Note 1) “Renesas Electronics” as used in this document means Renesas Electronics Corporation and also includes its majority-owned subsidiaries.

(Note 2) “Renesas Electronics product(s)” means any product developed or manufactured by or for Renesas Electronics.

BIPOLAR ANALOG INTEGRATED CIRCUIT  
**μPC79Mxx Series**

THREE TERMINAL NEGATIVE VOLTAGE REGULATOR

<R> **DESCRIPTION**

The μPC79Mxx Series are three-terminal negative output voltage stabilization power supply circuit of fixed output voltage. It regulates non-stabilized DC input voltage to output stabilized fixed voltage.

The six types of voltage value are -5 V, -8 V, -12 V, -15 V, -18 V and -24 V, and they can be respectively used as power supply circuit with maximum current capacity 500 mA.

**FEATURES**

- Output current : 500 mA
- On-chip some protection circuits  
(over current protection, SOA protection and thermal shut down)
- Low noise

<R> **ORDERING INFORMATION**

Part Number	Package	Output Voltage	Marking	Package Type
μPC79M05HF	3-PIN PLASTIC SIP (MP-45G) (Isolated TO-220)	-5 V	79M05	Packed in envelope
μPC79M05HF-AZ <sup>Note</sup>	3-PIN PLASTIC SIP (MP-45G) (Isolated TO-220)	-5 V	79M05	Packed in envelope
μPC79M08HF	3-PIN PLASTIC SIP (MP-45G) (Isolated TO-220)	-8 V	79M08	Packed in envelope
μPC79M08HF-AZ <sup>Note</sup>	3-PIN PLASTIC SIP (MP-45G) (Isolated TO-220)	-8 V	79M08	Packed in envelope
μPC79M12HF	3-PIN PLASTIC SIP (MP-45G) (Isolated TO-220)	-12 V	79M12	Packed in envelope
μPC79M12HF-AZ <sup>Note</sup>	3-PIN PLASTIC SIP (MP-45G) (Isolated TO-220)	-12 V	79M12	Packed in envelope
μPC79M15HF	3-PIN PLASTIC SIP (MP-45G) (Isolated TO-220)	-15 V	79M15	Packed in envelope
μPC79M15HF-AZ <sup>Note</sup>	3-PIN PLASTIC SIP (MP-45G) (Isolated TO-220)	-15 V	79M15	Packed in envelope
μPC79M18HF	3-PIN PLASTIC SIP (MP-45G) (Isolated TO-220)	-18 V	79M18	Packed in envelope
μPC79M18HF-AZ <sup>Note</sup>	3-PIN PLASTIC SIP (MP-45G) (Isolated TO-220)	-18 V	79M18	Packed in envelope
μPC79M24HF	3-PIN PLASTIC SIP (MP-45G) (Isolated TO-220)	-24 V	79M24	Packed in envelope
μPC79M24HF-AZ <sup>Note</sup>	3-PIN PLASTIC SIP (MP-45G) (Isolated TO-220)	-24 V	79M24	Packed in envelope

**Note** Pb-free (This product does not contain Pb in external electrode).

**Remark** Output voltage -5 V product is written in the text as μPC79M05.  
 It applies to other output voltage products as same.

The information in this document is subject to change without notice. Before using this document, please confirm that this is the latest version.  
 Not all products and/or types are available in every country. Please check with an NEC Electronics sales representative for availability and additional information.

**PIN CONFIGURATION (Marking Side)**

3-PIN PLASTIC SIP (MP-45G) (Isolated TO-220)

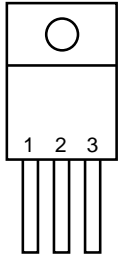

- 1: GND
- 2: INPUT
- 3: OUTPUT

**EQUIVALENT CIRCUIT**

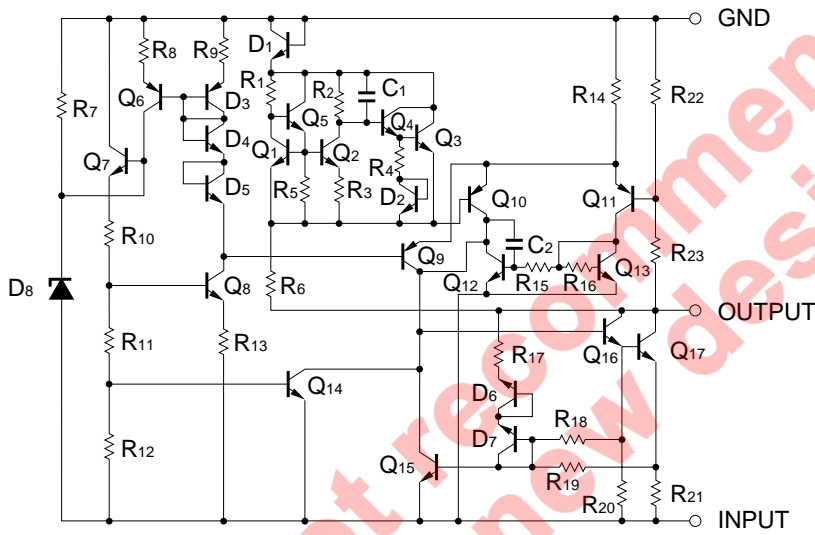

**ABSOLUTE MAXIMUM RATINGS (TA = 25°C, unless otherwise specified)**

Parameter	Symbol	Rating	Unit
Input Voltage	V <sub>IN</sub>	-35/-40 <sup>Note1</sup>	V
Internal Power Dissipation	P <sub>T</sub>	15 <sup>Note2</sup>	W
Operating Ambient Temperature	T <sub>A</sub>	-20 to +85	°C
Operating Junction Temperature	T <sub>J</sub>	-20 to +150	°C
Storage Temperature	T <sub>stg</sub>	-55 to +150	°C
Thermal Resistance (junction to case)	R <sub>th(J-C)</sub>	7	°C/W
Thermal Resistance (junction to ambient)	R <sub>th(J-A)</sub>	65	°C/W

**Notes 1.** μPC79M05, 08, 12, 15, 18 : -35 V, μPC79M24 : -40 V

**2.** Internally limited. When operating junction temperature rise above 150°C, the internal protection circuit shutdown output voltage.

<R> **Caution** Product quality may suffer if the absolute maximum rating is exceeded even momentarily for any parameter. That is, the absolute maximum ratings are rated values at which the product is on the verge of suffering physical damage, and therefore the product must be used under conditions that ensure that the absolute maximum ratings are not exceeded.

<R> **TYPICAL CONNECTION**

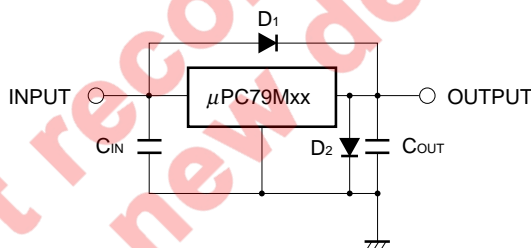

C<sub>IN</sub> : Required if regulator is located an appreciable distance from power supply filter. (More than 2 μF)

C<sub>OUT</sub>: Connect it within 2 cm from OUTPUT pin and GND pin (More than 1 μF).

D<sub>1</sub> : Needed for V<sub>IN</sub> > V<sub>O</sub>.

D<sub>2</sub> : Needed for V<sub>O</sub> > GND.

**RECOMMENDED OPERATING CONDITIONS**

Parameter	Symbol	Type Number	MIN.	TYP.	MAX.	Unit
Input Voltage	V <sub>IN</sub>	μPC79M05	-7	-10	-25	V
		μPC79M08	-10.5	-14	-25	V
		μPC79M12	-14.5	-19	-30	V
		μPC79M15	-17.5	-23	-30	V
		μPC79M18	-21	-27	-33	V
		μPC79M24	-27	-33	-38	V
Output Current	I <sub>o</sub>	All	5		350	mA
Operating Ambient Temperature	T <sub>A</sub>	All	-20		+85	°C
Operating Junction Temperature	T <sub>J</sub>	All	-20		+125	°C

<R>

ELECTRICAL CHARACTERISTICS

μPC79M05 (V<sub>IN</sub> = -10 V, I<sub>O</sub> = 350 mA, 0°C ≤ T<sub>J</sub> ≤ +125°C, C<sub>IN</sub> = 2.2 μF, C<sub>OUT</sub> = 1 μF, unless otherwise specified)

Parameter	Symbol	Conditions	MIN.	TYP.	MAX.	Unit
Output Voltage	V <sub>O</sub>	T <sub>J</sub> = 25°C	-4.8	-5.0	-5.2	V
		-7 V ≤ V <sub>IN</sub> ≤ -25 V, 5 mA ≤ I <sub>O</sub> ≤ 350 mA	-4.75		-5.25	V
Line Regulation	REG <sub>IN</sub>	T <sub>J</sub> = 25°C, -7 V ≤ V <sub>IN</sub> ≤ -25 V		18	50	mV
		T <sub>J</sub> = 25°C, -8 V ≤ V <sub>IN</sub> ≤ -18 V		10	30	mV
Load Regulation	REG <sub>L</sub>	T <sub>J</sub> = 25°C, 5 mA ≤ I <sub>O</sub> ≤ 500 mA		15	100	mV
		T <sub>J</sub> = 25°C, 5 mA ≤ I <sub>O</sub> ≤ 350 mA		10		mV
Quiescent Current	I <sub>BIAS</sub>	T <sub>J</sub> = 25°C		4.3	6.0	mA
Quiescent Current Change	ΔI <sub>BIAS</sub>	-8 V ≤ V <sub>IN</sub> ≤ -25 V			0.5	mA
		5 mA ≤ I <sub>O</sub> ≤ 350 mA			0.4	mA
Output Noise Voltage	V <sub>n</sub>	T <sub>J</sub> = 25°C, 10 Hz ≤ f ≤ 100 kHz		45	200	μV <sub>r.m.s.</sub>
Ripple Rejection	R•R	T <sub>J</sub> = 25°C, -8 V ≤ V <sub>IN</sub> ≤ -18 V, f = 120 Hz, I <sub>O</sub> = 100 mA	50	72		dB
Dropout Voltage	V <sub>DIF</sub>	T <sub>J</sub> = 25°C		1.1		V
Short Circuit Current	I <sub>Oshort</sub>	T <sub>J</sub> = 25°C, V <sub>IN</sub> = -25 V		500		mA
Peak Output Current	I <sub>Opeak</sub>	T <sub>J</sub> = 25°C	620	880	1020	mA
Temperature Coefficient of Output Voltage	ΔV <sub>O</sub> /ΔT	I <sub>O</sub> = 5 mA		0.2		mV/°C

μPC79M08 (V<sub>IN</sub> = -14 V, I<sub>O</sub> = 350 mA, 0°C ≤ T<sub>J</sub> ≤ +125°C, C<sub>IN</sub> = 2.2 μF, C<sub>OUT</sub> = 1 μF, unless otherwise specified)

Parameter	Symbol	Conditions	MIN.	TYP.	MAX.	Unit
Output Voltage	V <sub>O</sub>	T <sub>J</sub> = 25°C	-7.7	-8.0	-8.3	V
		-10.5 V ≤ V <sub>IN</sub> ≤ -25 V, 5 mA ≤ I <sub>O</sub> ≤ 350 mA	-7.6		-8.4	V
Line Regulation	REG <sub>IN</sub>	T <sub>J</sub> = 25°C, -10.5 V ≤ V <sub>IN</sub> ≤ -25 V		20	80	mV
		T <sub>J</sub> = 25°C, -11 V ≤ V <sub>IN</sub> ≤ -21 V		15	50	mV
Load Regulation	REG <sub>L</sub>	T <sub>J</sub> = 25°C, 5 mA ≤ I <sub>O</sub> ≤ 500 mA		20	160	mV
		T <sub>J</sub> = 25°C, 5 mA ≤ I <sub>O</sub> ≤ 350 mA		15		mV
Quiescent Current	I <sub>BIAS</sub>	T <sub>J</sub> = 25°C		4.3	6.0	mA
Quiescent Current Change	ΔI <sub>BIAS</sub>	-10.5 V ≤ V <sub>IN</sub> ≤ -25 V			0.5	mA
		5 mA ≤ I <sub>O</sub> ≤ 350 mA			0.4	mA
Output Noise Voltage	V <sub>n</sub>	T <sub>J</sub> = 25°C, 10 Hz ≤ f ≤ 100 kHz		65	220	μV <sub>r.m.s.</sub>
Ripple Rejection	R•R	T <sub>J</sub> = 25°C, -11.5 V ≤ V <sub>IN</sub> ≤ -21.5 V, f = 120 Hz, I <sub>O</sub> = 100 mA	50	66		dB
Dropout Voltage	V <sub>DIF</sub>	T <sub>J</sub> = 25°C		1.1		V
Short Circuit Current	I <sub>Oshort</sub>	T <sub>J</sub> = 25°C, V <sub>IN</sub> = -25 V		500		mA
Peak Output Current	I <sub>Opeak</sub>	T <sub>J</sub> = 25°C	620	880	1020	mA
Temperature Coefficient of Output Voltage	ΔV <sub>O</sub> /ΔT	I <sub>O</sub> = 5 mA		0.3		mV/°C

**μPC79M12 (V<sub>IN</sub> = -19 V, I<sub>o</sub> = 350 mA, 0°C ≤ T<sub>J</sub> ≤ +125°C, C<sub>IN</sub> = 2.2 μF, C<sub>OUT</sub> = 1 μF, unless otherwise specified)**

Parameter	Symbol	Conditions	MIN.	TYP.	MAX.	Unit
Output Voltage	V <sub>o</sub>	T <sub>J</sub> = 25°C	-11.5	-12.0	-12.5	V
		-14.5 V ≤ V <sub>IN</sub> ≤ -30 V, 5 mA ≤ I <sub>o</sub> ≤ 350 mA	-11.4		-12.6	V
Line Regulation	REG <sub>IN</sub>	T <sub>J</sub> = 25°C, -14.5 V ≤ V <sub>IN</sub> ≤ -30 V		25	80	mV
		T <sub>J</sub> = 25°C, -15 V ≤ V <sub>IN</sub> ≤ -25 V		20	50	mV
Load Regulation	REG <sub>L</sub>	T <sub>J</sub> = 25°C, 5 mA ≤ I <sub>o</sub> ≤ 500 mA		35	240	mV
		T <sub>J</sub> = 25°C, 5 mA ≤ I <sub>o</sub> ≤ 350 mA		25		mV
Quiescent Current	I <sub>BIAS</sub>	T <sub>J</sub> = 25°C		4.4	6.0	mA
Quiescent Current Change	ΔI <sub>BIAS</sub>	-14.5 V ≤ V <sub>IN</sub> ≤ -30 V			0.5	mA
		5 mA ≤ I <sub>o</sub> ≤ 350 mA			0.4	mA
Output Noise Voltage	V <sub>n</sub>	T <sub>J</sub> = 25°C, 10 Hz ≤ f ≤ 100 kHz		125	280	μV <sub>r.m.s.</sub>
Ripple Rejection	R•R	T <sub>J</sub> = 25°C, -15 V ≤ V <sub>IN</sub> ≤ -25 V, f = 120 Hz, I <sub>o</sub> = 100 mA	50	64		dB
Dropout Voltage	V <sub>DIF</sub>	T <sub>J</sub> = 25°C		1.1		V
Short Circuit Current	I <sub>Oshort</sub>	T <sub>J</sub> = 25°C, V <sub>IN</sub> = -30 V		400		mA
Peak Output Current	I <sub>Opeak</sub>	T <sub>J</sub> = 25°C	620	880	1020	mA
Temperature Coefficient of Output Voltage	ΔV <sub>o</sub> /ΔT	I <sub>o</sub> = 5 mA		0.4		mV/°C

**μPC79M15 (V<sub>IN</sub> = -23 V, I<sub>o</sub> = 350 mA, 0°C ≤ T<sub>J</sub> ≤ +125°C, C<sub>IN</sub> = 2.2 μF, C<sub>OUT</sub> = 1 μF, unless otherwise specified)**

Parameter	Symbol	Conditions	MIN.	TYP.	MAX.	Unit
Output Voltage	V <sub>o</sub>	T <sub>J</sub> = 25°C	-14.4	-15.0	-15.6	V
		-17.5 V ≤ V <sub>IN</sub> ≤ -30 V, 5 mA ≤ I <sub>o</sub> ≤ 350 mA	-14.25		-15.75	V
Line Regulation	REG <sub>IN</sub>	T <sub>J</sub> = 25°C, -17.5 V ≤ V <sub>IN</sub> ≤ -30 V		30	80	mV
		T <sub>J</sub> = 25°C, -18 V ≤ V <sub>IN</sub> ≤ -28 V		25	50	mV
Load Regulation	REG <sub>L</sub>	T <sub>J</sub> = 25°C, 5 mA ≤ I <sub>o</sub> ≤ 500 mA		50	240	mV
		T <sub>J</sub> = 25°C, 5 mA ≤ I <sub>o</sub> ≤ 350 mA		35		mV
Quiescent Current	I <sub>BIAS</sub>	T <sub>J</sub> = 25°C		4.4	6.0	mA
Quiescent Current Change	ΔI <sub>BIAS</sub>	-17.5 V ≤ V <sub>IN</sub> ≤ -30 V			0.5	mA
		5 mA ≤ I <sub>o</sub> ≤ 350 mA			0.4	mA
Output Noise Voltage	V <sub>n</sub>	T <sub>J</sub> = 25°C, 10 Hz ≤ f ≤ 100 kHz		150	360	μV <sub>r.m.s.</sub>
Ripple Rejection	R•R	T <sub>J</sub> = 25°C, -18.5 V ≤ V <sub>IN</sub> ≤ -28.5 V, f = 120 Hz, I <sub>o</sub> = 100 mA	50	62		dB
Dropout Voltage	V <sub>DIF</sub>	T <sub>J</sub> = 25°C		1.1		V
Short Circuit Current	I <sub>Oshort</sub>	T <sub>J</sub> = 25°C, V <sub>IN</sub> = -30 V		400		mA
Peak Output Current	I <sub>Opeak</sub>	T <sub>J</sub> = 25°C	620	880	1020	mA
Temperature Coefficient of Output Voltage	ΔV <sub>o</sub> /ΔT	I <sub>o</sub> = 5 mA		0.6		mV/°C

**μPC79M18 (V<sub>IN</sub> = -27 V, I<sub>o</sub> = 350 mA, 0°C ≤ T<sub>J</sub> ≤ +125°C, C<sub>IN</sub> = 2.2 μF, C<sub>OUT</sub> = 1 μF, unless otherwise specified)**

Parameter	Symbol	Conditions	MIN.	TYP.	MAX.	Unit
Output Voltage	V <sub>o</sub>	T <sub>J</sub> = 25°C	-17.3	-18.0	-18.7	V
		-21 V ≤ V <sub>IN</sub> ≤ -33 V, 5 mA ≤ I <sub>o</sub> ≤ 350 mA	-17.1		-18.9	V
Line Regulation	REG <sub>IN</sub>	T <sub>J</sub> = 25°C, -21 V ≤ V <sub>IN</sub> ≤ -33 V		30	80	mV
		T <sub>J</sub> = 25°C, -24 V ≤ V <sub>IN</sub> ≤ -30 V		25	50	mV
Load Regulation	REG <sub>L</sub>	T <sub>J</sub> = 25°C, 5 mA ≤ I <sub>o</sub> ≤ 500 mA		60	300	mV
		T <sub>J</sub> = 25°C, 5 mA ≤ I <sub>o</sub> ≤ 350 mA		45		mV
Quiescent Current	I <sub>BIAS</sub>	T <sub>J</sub> = 25°C		4.4	6.0	mA
Quiescent Current Change	ΔI <sub>BIAS</sub>	-21 V ≤ V <sub>IN</sub> ≤ -33 V			0.5	mA
		5 mA ≤ I <sub>o</sub> ≤ 350 mA			0.4	mA
Output Noise Voltage	V <sub>n</sub>	T <sub>J</sub> = 25°C, 10 Hz ≤ f ≤ 100 kHz		200	440	μV <sub>r.m.s.</sub>
Ripple Rejection	R•R	T <sub>J</sub> = 25°C, -22 V ≤ V <sub>IN</sub> ≤ -32 V, f = 120 Hz, I <sub>o</sub> = 100 mA	50	60		dB
Dropout Voltage	V <sub>DIF</sub>	T <sub>J</sub> = 25°C		1.1		V
Short Circuit Current	I <sub>Oshort</sub>	T <sub>J</sub> = 25°C, V <sub>IN</sub> = -33 V		350		mA
Peak Output Current	I <sub>Opeak</sub>	T <sub>J</sub> = 25°C	620	880	1020	mA
Temperature Coefficient of Output Voltage	ΔV <sub>o</sub> /ΔT	I <sub>o</sub> = 5 mA		0.8		mV/°C

**μPC79M24 (V<sub>IN</sub> = -33 V, I<sub>o</sub> = 350 mA, 0°C ≤ T<sub>J</sub> ≤ +125°C, C<sub>IN</sub> = 2.2 μF, C<sub>OUT</sub> = 1 μF, unless otherwise specified)**

Parameter	Symbol	Conditions	MIN.	TYP.	MAX.	Unit
Output Voltage	V <sub>o</sub>	T <sub>J</sub> = 25°C	-23.0	-24.0	-25.0	V
		-27 V ≤ V <sub>IN</sub> ≤ -38 V, 5 mA ≤ I <sub>o</sub> ≤ 350 mA	-22.8		-25.2	V
Line Regulation	REG <sub>IN</sub>	T <sub>J</sub> = 25°C, -27 V ≤ V <sub>IN</sub> ≤ -38 V		30	80	mV
		T <sub>J</sub> = 25°C, -30 V ≤ V <sub>IN</sub> ≤ -36 V		25	50	mV
Load Regulation	REG <sub>L</sub>	T <sub>J</sub> = 25°C, 5 mA ≤ I <sub>o</sub> ≤ 500 mA		80	360	mV
		T <sub>J</sub> = 25°C, 5 mA ≤ I <sub>o</sub> ≤ 350 mA		50		mV
Quiescent Current	I <sub>BIAS</sub>	T <sub>J</sub> = 25°C		4.5	6.0	mA
Quiescent Current Change	ΔI <sub>BIAS</sub>	-27 V ≤ V <sub>IN</sub> ≤ -38 V			0.5	mA
		5 mA ≤ I <sub>o</sub> ≤ 350 mA			0.4	mA
Output Noise Voltage	V <sub>n</sub>	T <sub>J</sub> = 25°C, 10 Hz ≤ f ≤ 100 kHz		250	600	μV <sub>r.m.s.</sub>
Ripple Rejection	R•R	T <sub>J</sub> = 25°C, -28 V ≤ V <sub>IN</sub> ≤ -38 V, f = 120 Hz, I <sub>o</sub> = 100 mA	50	57		dB
Dropout Voltage	V <sub>DIF</sub>	T <sub>J</sub> = 25°C		1.1		V
Short Circuit Current	I <sub>Oshort</sub>	T <sub>J</sub> = 25°C, V <sub>IN</sub> = -38 V		200		mA
Peak Output Current	I <sub>Opeak</sub>	T <sub>J</sub> = 25°C	620	880	1020	mA
Temperature Coefficient of Output Voltage	ΔV <sub>o</sub> /ΔT	I <sub>o</sub> = 5 mA		1.0		mV/°C



TYPICAL CHARACTERISTICS ( $T_J = 25^\circ\text{C}$ , unless otherwise specified)

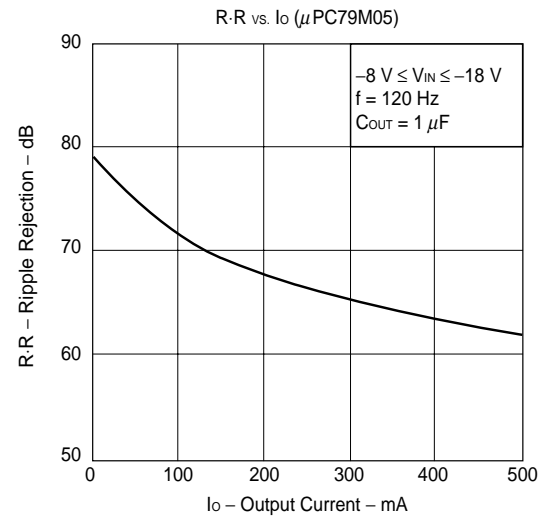
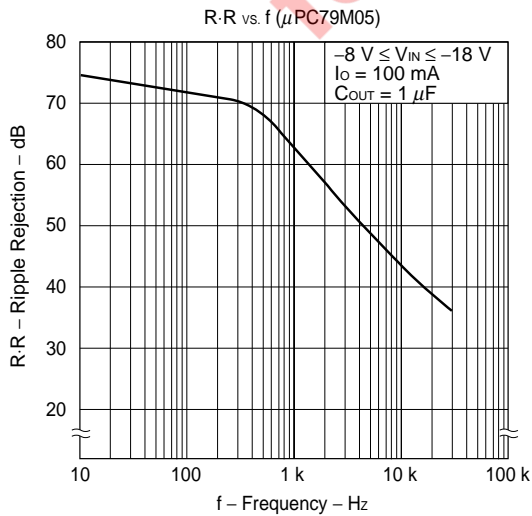
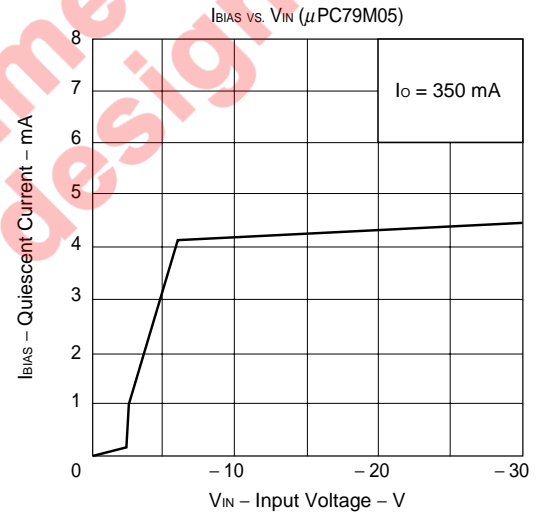
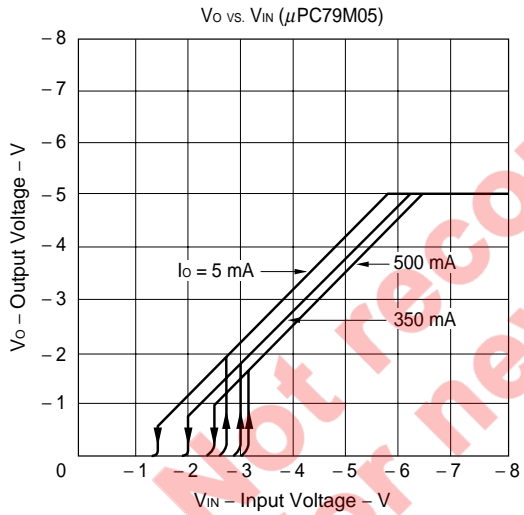
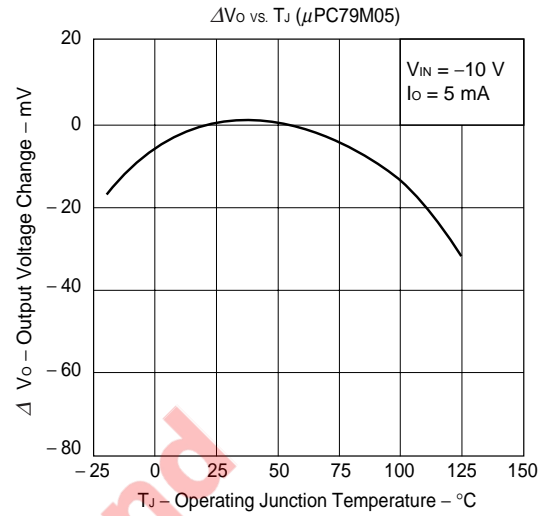
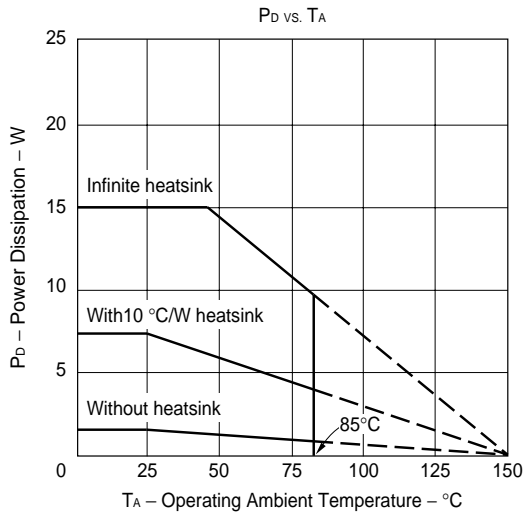

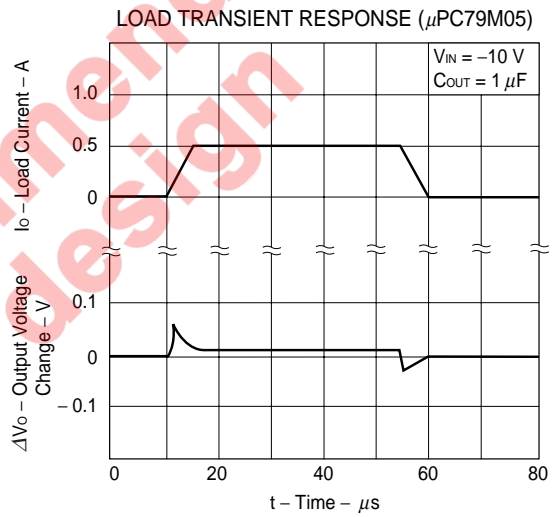
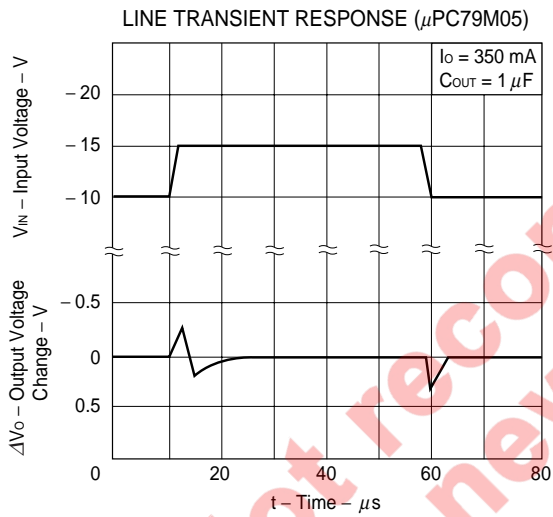
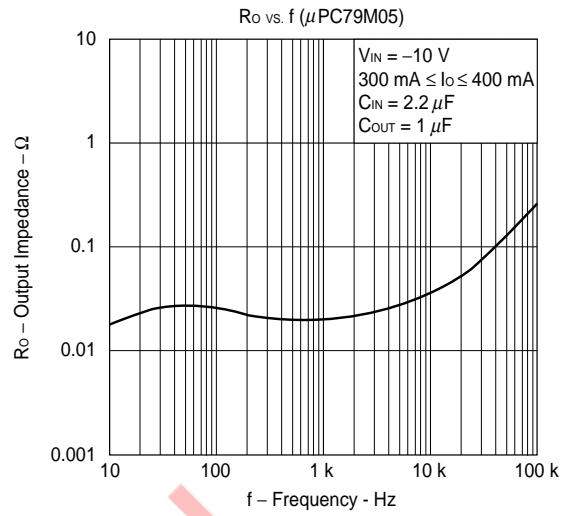
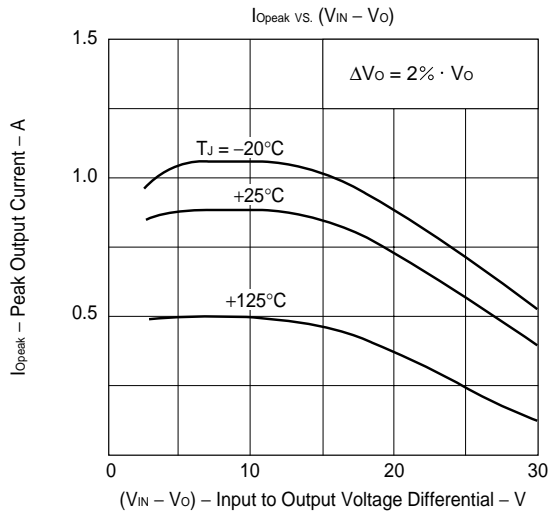

<R> PACKAGE DRAWING (Unit: mm)

3PIN PLASTIC SIP (MP-45G)

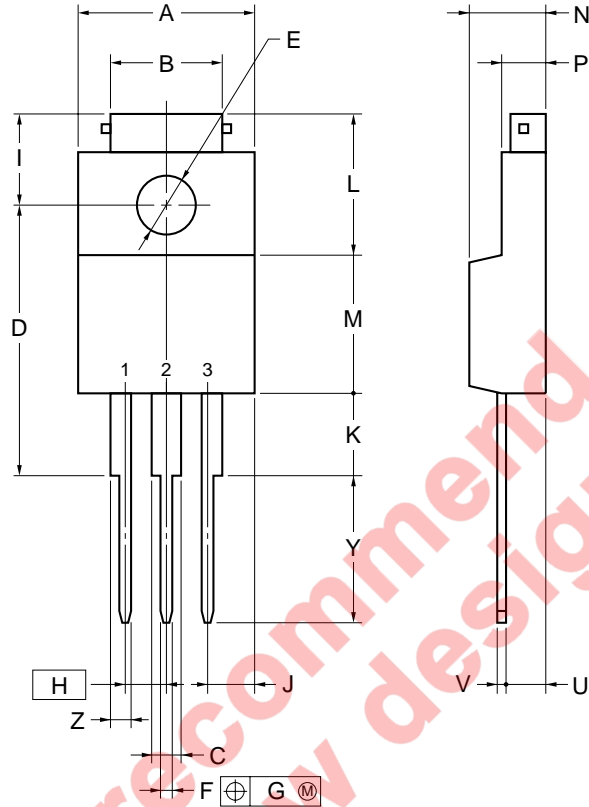

**NOTE**

Each lead centerline is located within 0.25 mm of its true position (T.P.) at maximum material condition.

ITEM	MILLIMETERS
A	10.0±0.2
B	7.0±0.2
C	1.50±0.2
D	17.0±0.3
E	∅3.3±0.2
F	0.75±0.10
G	0.25
H	2.54 (T.P.)
I	5.0±0.3
J	2.46±0.2
K	5.0±0.2
L	8.5±0.2
M	8.5±0.2
N	4.5±0.2
P	2.8±0.2
U	2.4±0.5
V	0.65±0.10
Y	8.9±0.7
Z	1.30±0.2

P3HF-254B-4

<R> **RECOMMENDED SOLDERING CONDITIONS**

The μPC79Mxx Series should be soldered and mounted under the following recommended conditions.

For soldering methods and conditions other than those recommended below, contact an NEC Electronics sales representative.

For technical information, see the following website.

**Semiconductor Device Mount Manual (<http://www.necel.com/pkg/en/mount/index.html>)**

**Through-hole devices**

**μPC79M05HF, 79M08HF, 79M12HF, 79M15HF, 79M18HF, 79M24HF,**

**μPC79M05HF-AZ, 79M08HF-AZ, 79M12HF-AZ, 79M15HF-AZ, 79M18HF-AZ, 79M24HF-AZ : 3-PIN PLASTIC SIP (MP-45G)**

**(Isolated TO-220)**

Process	Conditions	Symbol
Wave soldering (only to leads)	Solder temperature: 260°C or below, Flow time: 10 seconds or less, Maximum number of flow processes: 1 time.	WS60-00-1
Partial heating method	Pin temperature: 350°C or below, Heat time: 3 seconds or less (Per each pin).	P350

**Caution For through-hole device, the wave soldering process must be applied only to leads, and make sure that the package body does not get jet soldered.**

<R> **REFERENCE DOCUMENTS**

Document Name	Document No.
Usage of Three-Terminal Regulators User's Manual	G12702E
Semiconductor Device Mount Manual	<a href="http://www.necel.com/pkg/en/mount/index.html">http://www.necel.com/pkg/en/mount/index.html</a>
Review of Quality and Reliability Handbook Information	C12769E

- **The information in this document is current as of January, 2007. The information is subject to change without notice. For actual design-in, refer to the latest publications of NEC Electronics data sheets or data books, etc., for the most up-to-date specifications of NEC Electronics products. Not all products and/or types are available in every country. Please check with an NEC Electronics sales representative for availability and additional information.**

- No part of this document may be copied or reproduced in any form or by any means without the prior written consent of NEC Electronics. NEC Electronics assumes no responsibility for any errors that may appear in this document.
- NEC Electronics does not assume any liability for infringement of patents, copyrights or other intellectual property rights of third parties by or arising from the use of NEC Electronics products listed in this document or any other liability arising from the use of such products. No license, express, implied or otherwise, is granted under any patents, copyrights or other intellectual property rights of NEC Electronics or others.
- Descriptions of circuits, software and other related information in this document are provided for illustrative purposes in semiconductor product operation and application examples. The incorporation of these circuits, software and information in the design of a customer's equipment shall be done under the full responsibility of the customer. NEC Electronics assumes no responsibility for any losses incurred by customers or third parties arising from the use of these circuits, software and information.
- While NEC Electronics endeavors to enhance the quality, reliability and safety of NEC Electronics products, customers agree and acknowledge that the possibility of defects thereof cannot be eliminated entirely. To minimize risks of damage to property or injury (including death) to persons arising from defects in NEC Electronics products, customers must incorporate sufficient safety measures in their design, such as redundancy, fire-containment and anti-failure features.
- NEC Electronics products are classified into the following three quality grades: "Standard", "Special" and "Specific".

The "Specific" quality grade applies only to NEC Electronics products developed based on a customer-designated "quality assurance program" for a specific application. The recommended applications of an NEC Electronics product depend on its quality grade, as indicated below. Customers must check the quality grade of each NEC Electronics product before using it in a particular application.

"Standard": Computers, office equipment, communications equipment, test and measurement equipment, audio and visual equipment, home electronic appliances, machine tools, personal electronic equipment and industrial robots.

"Special": Transportation equipment (automobiles, trains, ships, etc.), traffic control systems, anti-disaster systems, anti-crime systems, safety equipment and medical equipment (not specifically designed for life support).

"Specific": Aircraft, aerospace equipment, submersible repeaters, nuclear reactor control systems, life support systems and medical equipment for life support, etc.

The quality grade of NEC Electronics products is "Standard" unless otherwise expressly specified in NEC Electronics data sheets or data books, etc. If customers wish to use NEC Electronics products in applications not intended by NEC Electronics, they must contact an NEC Electronics sales representative in advance to determine NEC Electronics' willingness to support a given application.

(Note)

(1) "NEC Electronics" as used in this statement means NEC Electronics Corporation and also includes its majority-owned subsidiaries.

(2) "NEC Electronics products" means any product developed or manufactured by or for NEC Electronics (as defined above).