

佛山市国星 RGB 器件事业部

FOSHAN NATIONSTAR RGB DIVISION

产品规格书 SPECIFICATION

| | | | |
|-----------------------|--|-------------------|-----------------|
| 顾客名称 Customer | | 产品名称 Product | TOP LED |
| 顾客型号 Customer Type | | 产品型号 Type | NH-Z1415RGBA-SG |
| 顾客部品号 Customer No. | | 版本号 Version NO | A1 版 |



地址: 广东省佛山市禅城区华宝南路 18 号
 Add: NO.18 South Huabao Rd, Foshan, Guangdong, China
 电话 (Tel): 0757-83985605; 83985607; 82100231; 82100230
 传真 (Fax): 0757-82100223; 82100200
 邮编 (Zip): 528000
<http://www.nationstar.com>

| | | | |
|---------------------------------------|-------------|---------------|-------------------------------|
| 研发中心 Research & Development Center | | | 客户 (加盖公章) Customer (Stamp) |
| 制定 DRAW | 审核 CHECK | 批准 APPROVE | 确认 CONFIRM |
| | | | |
| 发放日期 (Release Date) : 2020-04-24 | | | |

NH-Z1415RGBA-SG

TOP Full-color LED

技术数据表 Technical Data Sheet

本产品属于表面贴装全彩器件, 采用外黑内白设计, 高对比度, 哑光封装, 无镜面反射。拥有多重防水功能, 高可靠性、长寿命、宽视角等特点, 是全户外显示装饰领域的理想选择。

These products are full-color SMD components with black frame and white refractor, high contrast, matt packaging and non-mirror reflection, which are featured by multiple waterproof performance, good reliability, long lifespan and wide viewing angle. They are designed for outdoor display and decoration applications.

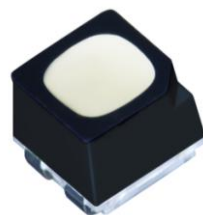

特性:

| | | | |
|-----------|---------|----------|---------|
| 管芯材料: | 红色 Red | 绿色 Green | 蓝色 Blue |
| Material: | AlGaInP | InGaN | InGaN |

Features:

- 封装材料: 环氧树脂
Encapsulation: Epoxy Resin
- 焊接方法: 无铅回流焊
Soldering methods: Pb-Free reflow soldering
- 光强度高, 功耗低, 可靠性好, 寿命长
High Luminous Intensity, Low Power Dissipation, good Reliability and Long Life
- 符合欧盟公布的 ROHS 指令要求
Complied With ROHS Directive

目录

Catalogue

| | |
|--|----|
| 电性参数 | |
| Electrical Characteristics..... | 2 |
| 典型特性曲线 | |
| Typical Characteristic Curves..... | 3 |
| 可靠性实验 | |
| Reliability Test Items and Conditions..... | 4 |
| 产品设计及操作建议 | |
| Product design and operating recommendation..... | 5 |
| 包装 | |
| Packaging..... | 6 |
| 焊接指导 | |
| Guideline for Soldering..... | 8 |
| 使用注意事项 | |
| Precautions..... | 10 |

* 产品规格如因工艺改进而有所改变, 恕不另行通知。

* The specifications of the product may be modified for improvement without notice.

光电参数

Electro-Optical Characteristics

✧ **极限参数 (温度=25℃)**
Absolute Maximum Ratings (Temperature=25 °C)

| 参数名称 Parameter | 符号 Symbol | 数值 Rating | 单位 Unit |
|-----------------------------------|------------------|--------------|------------|
| 正向电流 Forward Current | I _F | 25 | mA |
| 正向脉冲电流* Pulse Forward Current* | I _{FP} | 50 | mA |
| 反向电压 Reverse Voltage | V _R | 5 | V |
| 工作温度 Operating Temperature | T _{amd} | -30 ~ +85 | °C |
| 贮存温度 Storage Temperature | T _{stg} | -40 ~ +100 | °C |
| 功耗 Power Dissipation | 红 Red | 62.5 | mW |
| | 绿 Green | 85 | |
| | 蓝 Blue | 85 | |

* 注: 脉冲宽度≤0.1ms, 占空比≤1/10 * Note: Pulse Width≤0.1ms, Duty≤1/10

✧ **光电参数 (温度=25℃)**
Electro-Optical Characteristics (Temperature=25 °C)

| 参数名称 Parameter | 符号 Symbol | 条件 Condition | 颜色 Color | 最小值 Min. | 典型值 Typ. | 最大值 Max. | 单位 Unit |
|--------------------------------------|----------------|---------------------|-------------|-------------|-------------|-------------|------------|
| 反向电流 Reverse Current | I _R | V _R =5 V | 红 Red | | | 10 | μA |
| | | | 绿 Green | | | 10 | |
| | | | 蓝 Blue | | | 10 | |
| 正向电压 Forward Voltage | V _F | IF=15mA | 红 Red | 1.8 | 2.1 | 2.5 | V |
| | | IF=8mA | 绿 Green | 2.4 | 2.9 | 3.4 | |
| | | IF=5mA | 蓝 Blue | 2.4 | 2.9 | 3.4 | |
| 主波长 Dominant Wavelength | λ _D | IF=15mA | 红 Red | 615 | 622 | 630 | nm |
| | | IF=8mA | 绿 Green | 515 | 528 | 540 | |
| | | IF=5mA | 蓝 Blue | 460 | 469 | 480 | |
| 半波宽度 Spectrum Radiation Bandwidth | Δλ | IF=15mA | 红 Red | | | 24 | nm |
| | | IF=8mA | 绿 Green | | | 38 | |
| | | IF=5mA | 蓝 Blue | | | 28 | |
| 光强 Luminous Intensity | I _V | IF=15mA | 红 Red | 200 | 370 | 560 | mcd |
| | | IF=8mA | 绿 Green | 320 | 560 | 850 | |
| | | IF=5mA | 蓝 Blue | 40 | 80 | 130 | |
| 视角 View Angle | 2θ1/2 | | | | 110 | | deg. |

* 注: 以上参数仅供参考, 请以实物标签为准。我司给出的参数均由国星测试系统测得。
* Note: The parameters above only for your reference. In case of any discrepancy, please adhere to the label of our actual products. All parameters tested by the standard testing system of NationStar.

典型特性曲线

Typical Characteristics Curves

伏安特性
Volt-Ampere Characteristics

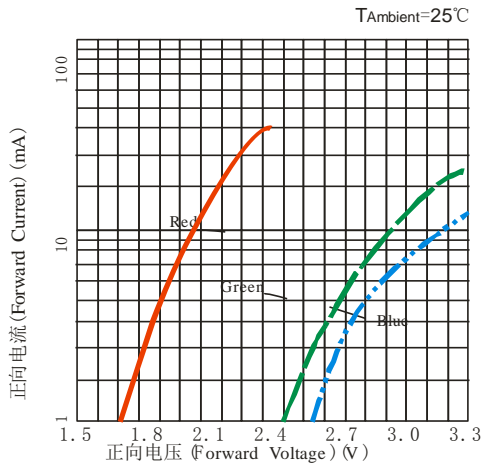

相对光强与正向电流特性
Relative Luminous Intensity VS Forward Current

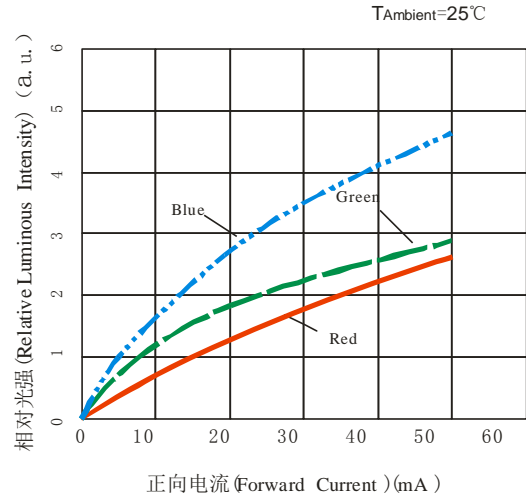

正向电流降额曲线
Forward Current Derating Curve

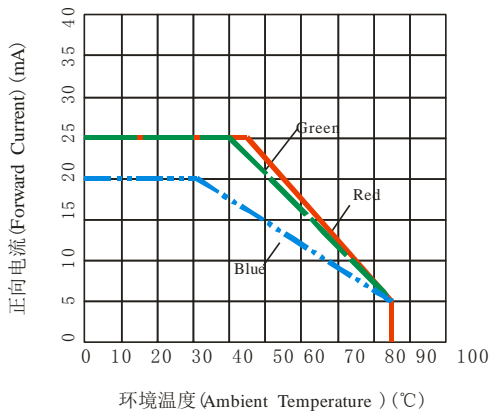

光强与环境温度曲线
Luminous Intensity VS Ambient Temperature

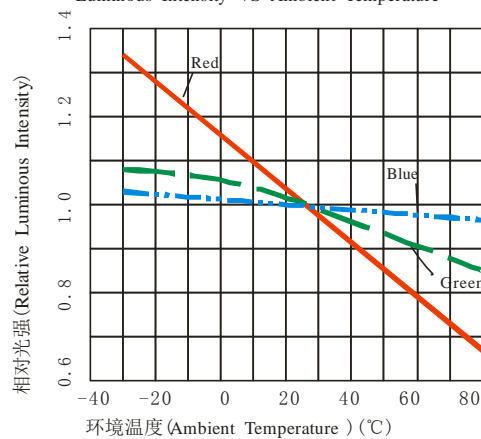

光谱分布特性曲线
Relative Spectral Distribution

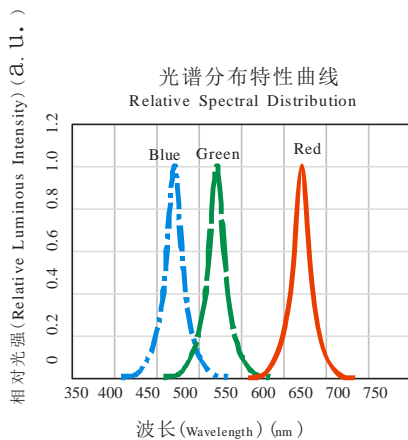

光强分布特性曲线
Typical Spatial Distribution

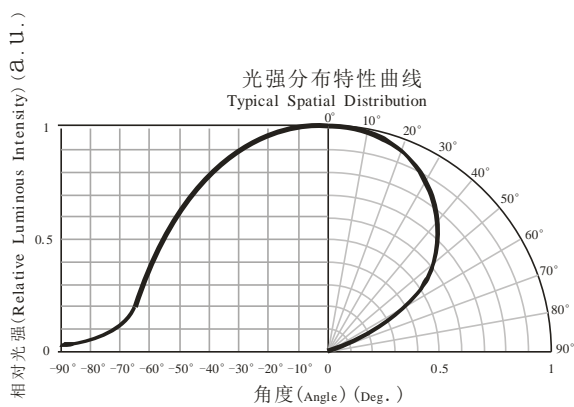

可靠性试验

Reliability Test Items And Conditions

| 实验项目 Test Items | 参考标准 Reference | 实验条件 Test Conditions | 时间 Time | 样品数 Quantity | 合格判据 Criterion |
|--|---------------------------------------|--|------------------------|-----------------|------------------------|
| 冷热冲击 Thermal Shock | MIL-STD-202G | -65°C(15min)←→150°C(15min) | 循环 100 次 100 cycles | 100 | 0/100 |
| 常温寿命试验 Room Temperature Operating Life | JESD22-A108D | Ta=25°C IF _R =5mA,IF _G =5mA,IF _B =5mA | 1000h | 20 | 见下表 See Table below |
| 高温高湿寿命试验 Temperature & Humidity Operating Life | JEITA ED-4701 100 103 JESD22-A108D | Ta=85°C RH=85% I _{FR} =5mA,I _{FG} =5mA,I _{FB} =5mA | 500h | 20 | 见下表 See Table below |
| 耐焊接热 Resistance to Soldering Heat | JEITA ED-4701 300 301 | Tsol*=260°C 10sec. | 2 次 2 times | 100 | 0/100 |
| 防水试验 Water Proof Test | IEC 60529:2001 | Immersing in 1m water | 24h | 100 | 0/100 |
| 紫外老化 UV aging | ASTM-G154 | (0.89±0.1) W/m ² @340nm, 60°C, 8h ←→50°C, 4h/ cycle | 循环 14 次 14 cycles | 20 | 见下表 See Table below |

寿命试验合格判断标准

Criteria For Passing Qualification Of Lifespan Test

| 测试项目 Test Items | 符号 Symbol | 测试条件 Test Conditions | 判定标准 Criteria For Judging Damage |
|--------------------------|----------------|----------------------------------|--|
| 正向电压 Forward Voltage | V _F | I _F = I _{FT} | 初始值 ±10% Initial Data ±10% |
| 反向电流 Reverse Current | I _R | V _R = 5V | I _R ≤ 10μA |
| 光强 Luminous Intensity | I _V | I _F = I _{FT} | 平均 I _V 衰减 ≤ 30%, 单个 I _V 衰减 ≤ 50% Average I _V degradation ≤ 30%; Single LED I _V degradation ≤ 50% |

* 注: T_{sol}-锡液温度; I_{FT}: 典型电流 * Note: T_{sol}-Temperature of tin liquid; I_{FT}: Typical current.

产品设计及操作建议

Product design and operational recommendation

1、产品设计 (单位: mm)

Product design (Unit: mm)

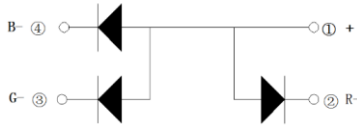
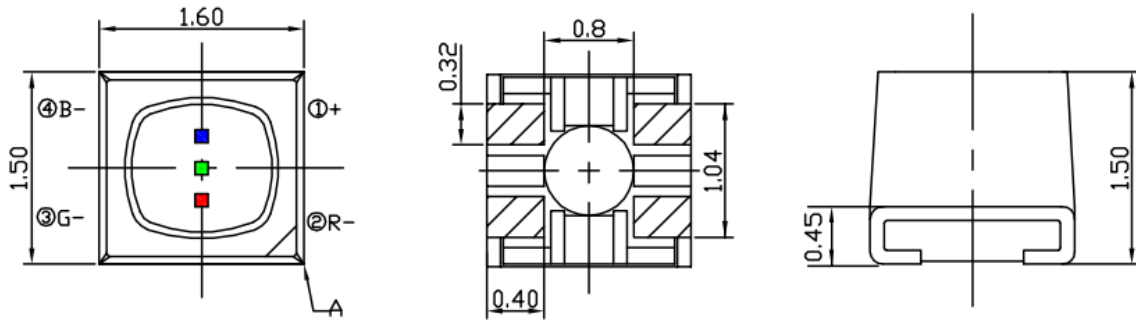

Note: A : 缺口标志
A : Nick Mark
公差: X.X ±0.1 mm X.XX ±0.05mm
Tolerances: X.X ±0.1 mm X.XX ±0.05mm

极性 Polarity

2、参考焊盘 (单位: mm)

Reference soldering pad (Unit: mm)

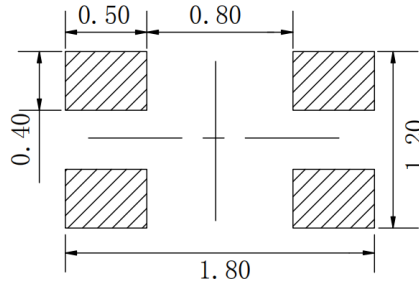

3、灌胶建议: 灌胶高度须大于等于 0.60mm 以上

Recommendation for glue filling: filling height must be higher than or equal to 0.60mm

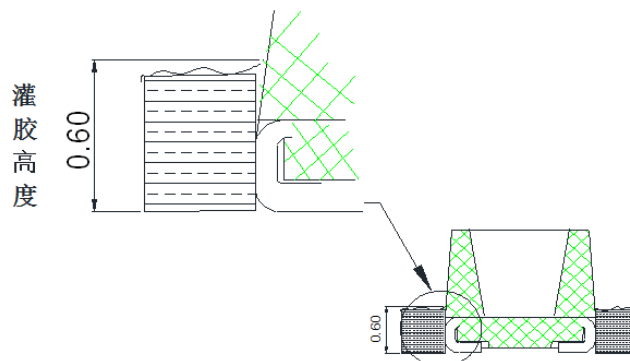

包装 (1)

Packaging (1)

◇ **载带 Carrier Tape**

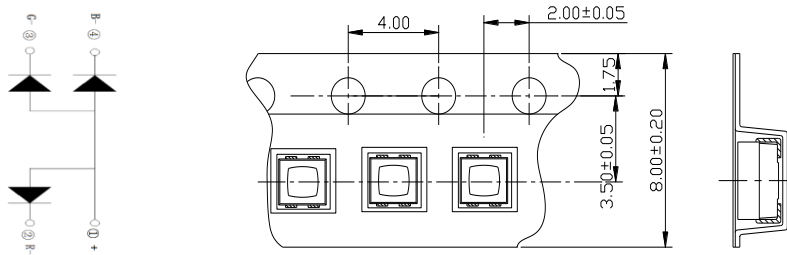

单位: mm, 未注公差: ±0.10mm

All dimensions in mm, tolerances unless mentioned is ±0.10 mm.

◇ **编带细节 Details Of Carrier Tape**

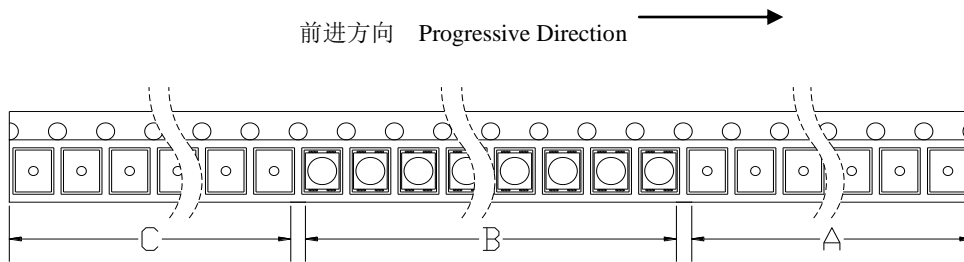

A: 引导, 空带, 500mm; B: 编载产品 10000 只; C: 尾部, 空带, 100mm
A: Leader, Empty, 500mm; B: 10000 Lamps Loaded; C: Trailer, Empty, 100mm.

◇ **带盘 Reel Dimension**

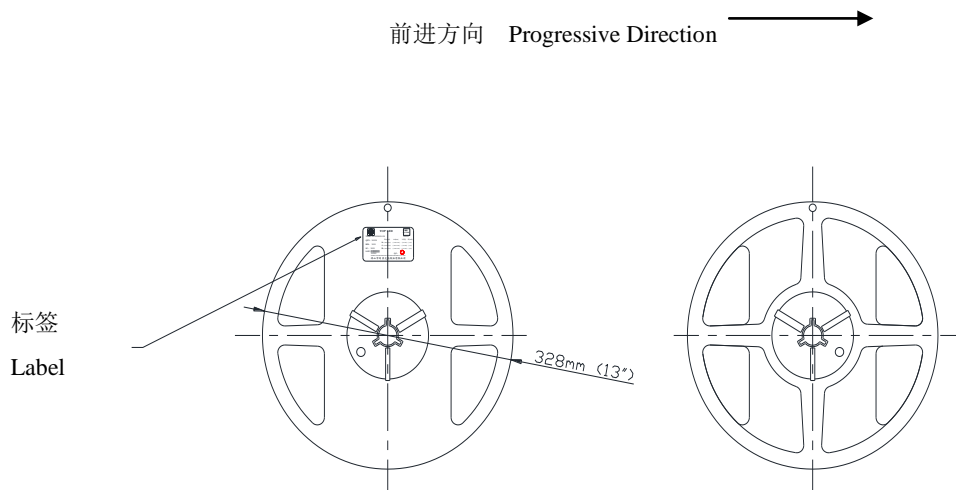

标签
Label

包装 (2)

Packaging (2)

◇ **防潮防静电包装 Moisture Proof and Anti-Electrostatic Foil Bag**

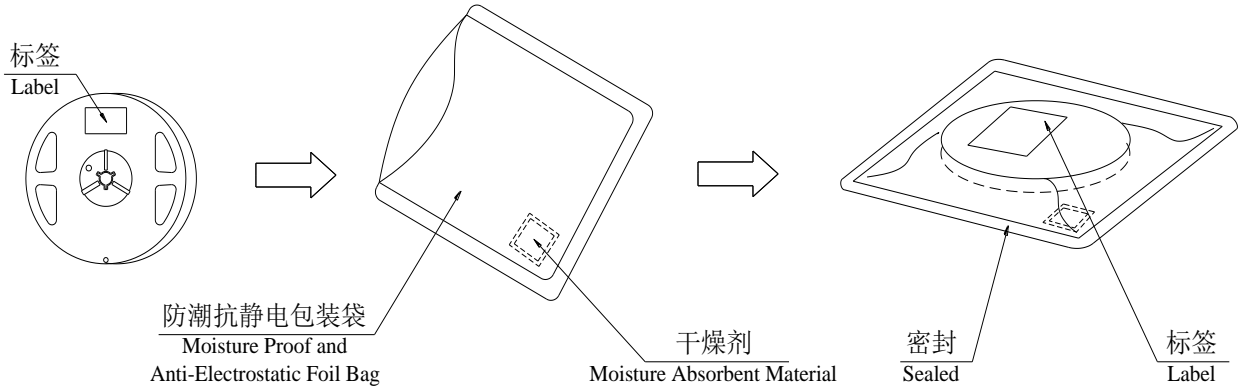

◇ **外包装箱 Cardboard Box**

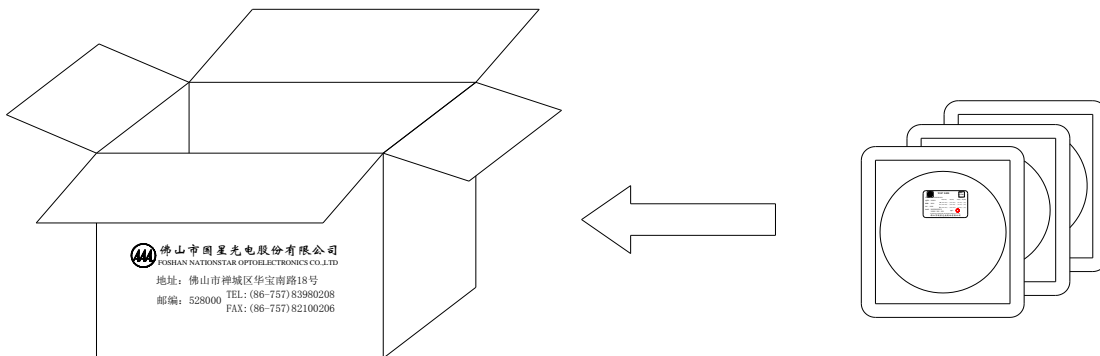

◇ **标签说明 Label Explanation**

TYPE: 产品型号

QTY: 数量 Quantity

BIN: 分档 Rank

SC: 分档代码 Bin Code

LOT: 批号 Lot Number

λd : 波长范围 Wavelength Range

IV: 光强范围 Luminous Intensity Range

VF: 正向电压范围 Forward Voltage Range

IF: 测试电流 Test Current

| | | |
|---|---------------------------------------|------|
| | TOP LED | |
| TYPE: XX-XXXXXX-XX | IV(mcd) λd (nm) VF(V) IF(mA) | XXXX |
| QTY: XXXX | R: (xxx-xxx) (xxx-xxx) (xx-xx) (xx) | |
| BIN: XXX | G: (xxx-xxx) (xxx-xxx) (xx-xx) (xx) | |
| SC: XXX | B: (xxx-xxx) (xxx-xxx) (xx-xx) (xx) | |
| LOT: XXXXXXXX XXXX | QC: | |
| FOSHAN NATIONSTAR OPTOELECTRONICS CO., LTD 佛山市国星光电股份有限公司 | | |

焊接指导 (1)

Guideline for Soldering (1)

1. 使用烙铁人手焊接

Hand Soldering

- 如使用手工焊接, 建议使用小于25瓦的电烙铁, 烙铁温度必须控制在315°C以下, 焊接时间需控制在3秒钟之内, 且每个电极只能焊接一次。

If manual soldering is used, the use of a soldering iron of less than 25W is recommended. The temperature of the iron must be kept below 315°C, with soldering time within 3 seconds and each electrode can be only soldered at one time.

- 手工焊接时电烙铁不可触及SMD LED表面。

The epoxy resin of the SMD LED should not contact the tip of the soldering iron.

- 焊接期间, 不可以对器件施加机械压力。

No mechanical stress should be exerted on the resin portion by the tip of the soldering iron.

- 器件外部温度在 40°C 以下时, 才可以对其进行处理。避免高温时操作对 LED 造成损伤。

Handing of the SMD LED should be done when the temperature of environment is below 40°C, in case of LED failures caused by thermal-mechanical stress in condition of high temperature .

2. 回流焊接: 推荐使用以下无铅回流焊接温度图进行。

Reflow Soldering: Use the conditions shown in the under Figure of Pb-Free Reflow Soldering.

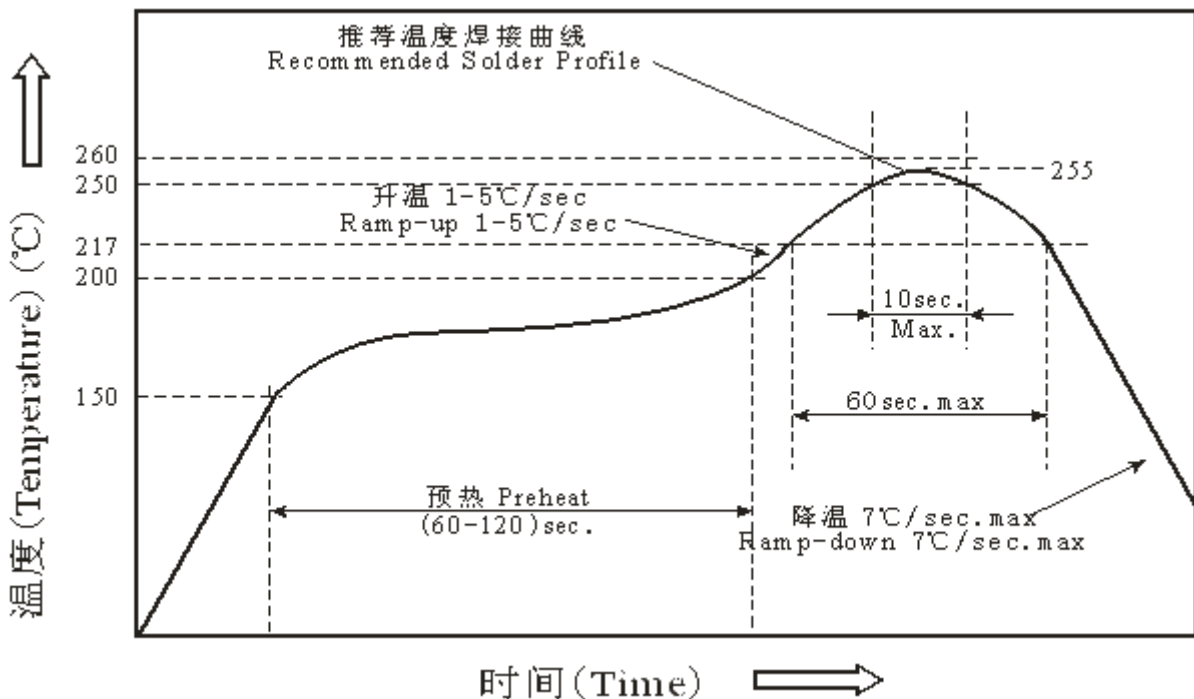

焊接指导 (2)

Guideline for Soldering (2)

- 回流焊接最多只能进行一次。
- Reflow soldering should not be done more than one time.
- 在回流焊接升温过程中, 请不要对 LED 施加任何压力。
- Stress on the LEDs should be avoided during heating in the reflow soldering process.
- 在焊接完成后, 待产品温度下降到室温之后, 再进行其他处理。
- After soldering, do not deal with the product before its temperature drop down to room temperature.

3. 清洗:

Cleaning

- 在焊接后推荐使用酒精(无水乙醇)进行清洗, 在温度不高于 30°C 的条件下持续 3 分钟, 不高于 50°C 的条件下持续 30 秒。使用其他类似溶剂清洗前, 请先确认使用的溶剂不会对 LED 的封装和环氧树脂部分造成损伤。

It is recommended that alcohol (Anhydrous ethanol) be used as a solvent for cleaning after soldering.

Cleaning is to go under 30°C for 3 minutes or 50°C for 30 seconds. When using other solvents, it should be confirmed beforehand whether the solvents will dissolve the package and the resin or not.

- 超声波清洗也是有效的方法, 一般最大功率不应超过 300W, 否则可能对 LED 造成损伤。请根据具体的情况预先测试清洗条件是否会对 LED 造成损伤。

Ultrasonic cleaning is also an effective way for cleaning. The influence of Ultrasonic cleaning on LED depends on factors such as ultrasonic power. Generally, the ultrasonic power should not be higher than 300W, otherwise it will cause LED damage. Before cleaning, a pre-test should be done to confirm if any damage to LEDs will occur.

*** 注意:** 此一般指导原则并不适用于所有 PCB 设计和焊接设备的配置。具体工艺受到诸多因素的影响, 请根据特定的 PCB 设计和焊接设备来确定焊接方案。

*** Note:** This general guideline may not apply to all PCB designs and configurations of all soldering equipment. The technique in practice is influenced by many factors, it should be specialized base on the PCB designs and configurations of the soldering equipment.

使用注意事项(1)

Precautions (1)

1. 贮存:

Storage

- 本产品使用密封防潮抗静电袋包装, 并附有干燥剂, 湿度卡。
Moisture proof, anti-electrostatic package and moisture absorbent material are used, to keep moisture to a minimum. Humidity indicator card inside to test if the products are moisted.
- 贮存环境为: 开封前, 产品贮存在温度 $<30^{\circ}\text{C}$, 湿度 $<60\%RH$ 环境中, 要求所有产品上线前均按要求进行烘烤除湿。
Storage environment: All the products should be stored in the environment of temperature $<30^{\circ}\text{C}$ and humidity $<60\%RH$ before foiled bags open and need to be baked before SMT.
- 开封前, 需检查包装袋有无漏气现象, 若已漏气, 请重新烘烤使用。
Before using, please check whether there is any air leakage or not, If the bag has leaked air, Please bake the product with below condition.
- 开封后, 请在温度 $<30^{\circ}\text{C}$, 湿度 $<60\%RH$ 环境下使用, 并于 8h 内完成贴片, 如果超过使用时间, 须将产品重新烘烤使用。
Before soldering ,the product must be stored under the condition of $<30^{\circ}\text{C}$ and $<60\%RH$. Under these conditions the SMD LEDs must be used (subject to reflow oven) within 8 hours.
- 烘烤条件: 两个月以内 (未受潮): $(70\pm 5)^{\circ}\text{C} \times 12\text{h}$
两个月以外 (未受潮): $(70\pm 5)^{\circ}\text{C} \times 24\text{h}$
确认已受潮或包装袋漏气或客户库存超过 6 个月: $(70\pm 5)^{\circ}\text{C} \times 48\text{h}$
Baking condition: Within 2 months' storage (undamped) : $(70\pm 5)^{\circ}\text{C} \times 12\text{h}$
After 2 months' storage (undamped): $(70\pm 5)^{\circ}\text{C} \times 24\text{h}$
Damped/Foiled bag leakage/ beyond 6 months' storage at customers' side: $(70\pm 5)^{\circ}\text{C} \times 48\text{h}$

2. 静电:

Static Electricity

- 静电和电涌会导致产品特性发生改变, 例如正向电压降低等, 如果情况严重甚至会损毁产品。所以在使用时必须采取有效的防静电措施。
Static electricity or surge voltage damages the LEDs. Damaged LEDs will show some unusual characteristics such as the forward voltage becomes lower, or the LEDs can not be lighted up. In view of the above, we should do some anti-static precautions when using the SMD LEDs.
- 所有相关的设备和机器都应该正确接地, 同时必须采取其他防止静电和电涌的措施。
All devices, equipments and machineries must be properly grounded, at the same time we should take measures to prevent anti-static and voltage surge.
- 使用防静电手环, 防静电垫子, 防静电工作服、工作鞋、手套, 防静电容器, 都是有效的防止静电和电涌的措施。
It is also recommended that anti-electrostatic wrist bands, pads, uniforms, gloves or containers can be used when dealing with the LEDs.

使用注意事项(2)

Precautions (2)

3. 设计建议:

Design Consideration

- 设计电路时, 通过 LED 的电流不能超过规定的最大值, 同时, 还需使用保护电阻, 否则, 微小的电压变化将会引起较大的电流变化, 可能导致产品损毁。

In designing a circuit, the current through each LED must not exceed the absolute maximum rating specified for each LED. In the meanwhile, resistors for protection should be applied, otherwise slight voltage shift will cause big current change which will probably lead to damage.

- 建议使用以下 (A) 电路, 该电路能够很好的调节通过每个 LED 的电流; 不推荐使用 (B) 电路, 该电路在持续的电压驱动下, LED 的正向电压 (V_F) 发生变化, 电流会随之而发生变化, 可能使某些 LED 承受高于规定的电流值。

It is recommended to use Circuit A which regulates the current flowing through each LED rather than Circuit B. When driving LEDs with a constant voltage in Circuit B, the current through the LEDs may vary due to the variation in Forward Voltage (V_F) of the LEDs. In the worst case, some LED may be subjected to stress in the excess of the Absolute Maximum Rating.

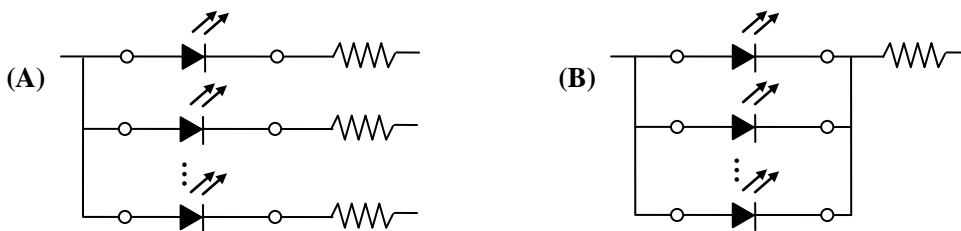

- LED 的特性容易因为自身的发热和环境的温度的改变而发生改变。温度的升高会降低 LED 的发光效率、影响发光颜色等, 所以在设计时应充分考虑散热的问题。

Thermal Design is paramount importance because heat generation may result in the Characteristics decline, such as brightness decrease, Color change and so on. Please consider the heat dissipation when making the system design.

4. 反压保护

Reverse voltage protection

- 通常 LED 的反向漏电流都很小, 不会影响正常使用。如果 LED 长期遭受超过其所能承受的反向电压冲击时, LED 会被损伤, 例如, 反向漏电流会迅速变大等。这样会引起显示屏零灰度下串光的发生。在设计中, 要注意控制反向电压, 建议加在 LED 上的反向电压值不超过 5V。

In general, the reverse current of LED is very small, which won't affect the normal use of components. But when it is often suffered the reverse voltage which exceeds the limit of the component then it will be damaged.

使用注意事项(3)

Precautions (3)

Such as the reverse current increase rapidly. And it will cause the string light when the screen is black. So please pay attention to controlling the reverse voltage which less than 5V is recommended.

5. 温度保护:

The safe temperature for LEDs working

- LED 在高温条件下, 衰减会加速, 本身应力也会增大, 若长期处于高温环境下, 极容易出现失效。对于高密度排列使用的情况, 建议在使用过程中灯面温度不超过 55°C, 灯脚温度不超过 75°C。

The high temperature will make the LEDs' Luminous Intensity decreased radically, if LEDs are used in hot environment for a long time, they will be disabled easily. When LEDs are used in a high density array, we suggest that the LEDs' surface temperature should be lower than 55°C and the legs' temperature should be lower than 75°C.

6. 其他事项:

Others

- 直接用手拿取产品不但会污染封装树脂表面, 也可能由于静电等因素导致产品性能的改变。过度的压力也可能直接影响封装内部的管芯和金线, 因此请勿对产品施加过度压力, 特别当产品处于高温状态下, 例如在回流焊接过程中。

When handling the product, touching the encapsulation with bare hands will not only contaminate its surface, but also have an effect on its optical characteristics. Excessive force to the encapsulation might result in catastrophic failure of the LEDs due to die breakage or wire deformation. For this reason, please do not put excessive stress on LEDs, especially when the LEDs are heated such as during Reflow Soldering.

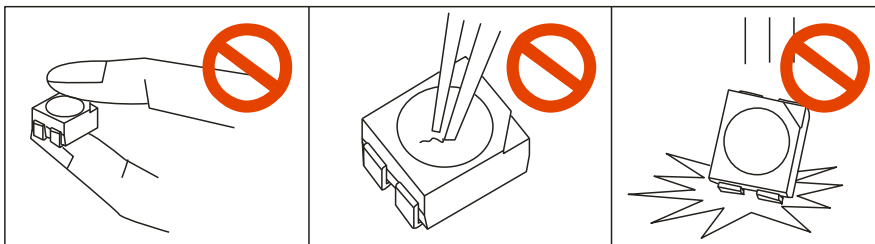

- LED 的环氧树脂封装部分相当脆弱, 请勿用坚硬、尖锐的物体刮、擦封装树脂部分。在用镊子夹取的时候也应当小心注意。

The epoxy resin of encapsulation is fragile, so please avoid scratch or friction over the epoxy resin surface.

While handling the product with tweezers, do not hold by the epoxy resin, be careful.

- LED 注意事项及防潮防护措施请参考我司《全彩 SMD LED 防潮使用手册》。

LED Precautions against moisture please refer to 《RGB SMD LED Moisture-proof User Instructions》.