

# 紫外 LED

## Ultraviolet LED

### NPD3535U2



#### Features & Benefits & Application

- 焊接方法：无铅回流焊
- Soldering methods: Pb-Free reflow soldering
- 光强度高，功耗低，可靠性好，寿命长
- Soldering methods: Pb-Free reflow soldering
- 符合欧盟公布的 ROHS 指令要求
- Complied With ROHS Directive
- 产品尺寸 3.6x3.6mm
- Package size 3.6x3.6mm
- 应用：表面杀菌、水杀菌等
- Application: Surface sterilization, Water sterilization, etc
- 发光波长：270-280nm
- Emitting Wavelength: 270-280nm

# DATASHEET NPD3535U2

## 目录

## Catalogue

参数.....	3
Electrical Characteristics.....	3
典型特性曲线.....	5
Typical Characteristics Curves .....	5
可靠性试验 .....	6
Reliability Test Items And Conditions .....	6
外形尺寸.....	7
Outline Dimension .....	7
包装.....	8
Packaging.....	8
焊接指导.....	10
Guideline for Soldering .....	10
使用注意事项.....	12
Precautions .....	12
附录：分档标准、命名规则.....	15
Appendix : Grading Standard 、 naming regulation.....	15

\* 产品规格如因工艺改进而有所改变，恕不另行通知。

\*The Specifications of the product may be modified for improvement without notice.

# DATASHEET NPD3535U2

## 1 电性参数

### 1 Electrical Characteristics

#### a 极限参数(T<sub>a</sub>=25℃) Absolute Maximum Ratings (T<sub>a</sub>=25℃):

参数名称 Parameter	符号 Symbol	数值 Rating	单位 Unit
正向电流 Forward Current	IF	60	mA
正向脉冲电流*Pulse Forward Current*	IFP	80	mA
反向电压 Reverse Voltage	VR	5	V
功耗 Power Dissipation	Pd	420	mW
工作温度 Operating Temperature	Topr	-30 ~ +60	℃
储存温度 Storage Temperature	Tstg	-40 ~ +100	℃
热阻 (结到焊点) Thermal resistance	RthJ-S	30	℃/W
结温 Junction Temperature	Tj	85	℃
焊接温度 Welding temperature	Tsol	回流焊 Reflow soldering : 260 ℃ for 10 sec	
抗静电能力 Antistatic ability ( HBM )	ESD	> 2000 ( 90% )	V

\* 注：脉冲宽度≤0.1ms，占空比≤1/10

\* Note：Pulse width≤0.1ms，Duty≤1/10

# DATASHEET NPD3535U2

**b 光电参数** ( $T_a=25^{\circ}\text{C}$ ,  $I_F=40\text{mA}$ ) Electro-Optical Characteristics ( $T_a=25^{\circ}\text{C}$ ,  $I_F=40\text{mA}$ ) :

参数名称 Parameter	符号 Symbol	最小值 Min.	典型值 Typ.	最大值 Max.	单位 Unit
正向电压 Forward Voltage	VF	5.0	6.0	7.0	V
辐射通量 Radiant Flux	$\Phi_e$	4.0	5.0	7.0	mW
峰值波长 Peak Wavelength	$\lambda_p$	270	275	280	nm
半峰宽 SpectrumHalf Width	$\Delta\lambda$	-	11	-	nm
出光角度 View Angle	$2\theta_{1/2}$	-	115	-	$^{\circ}$

# DATASHEET NPD3535U2

## 2 典型特性曲线

### 2 Typical Characteristics Curves

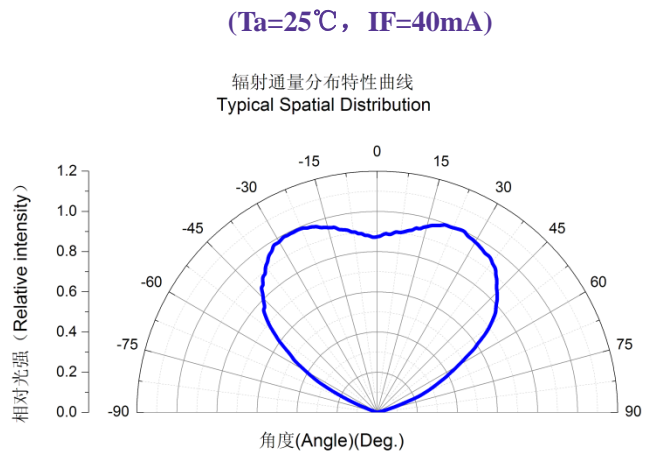
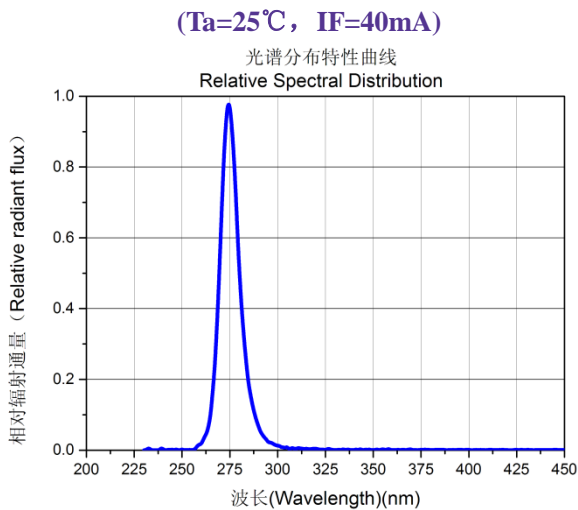
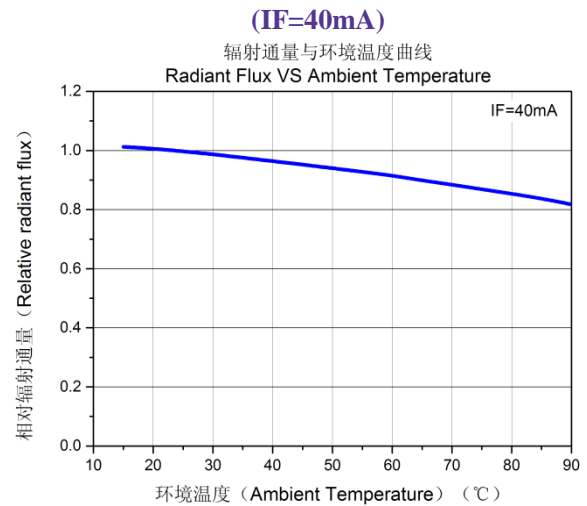
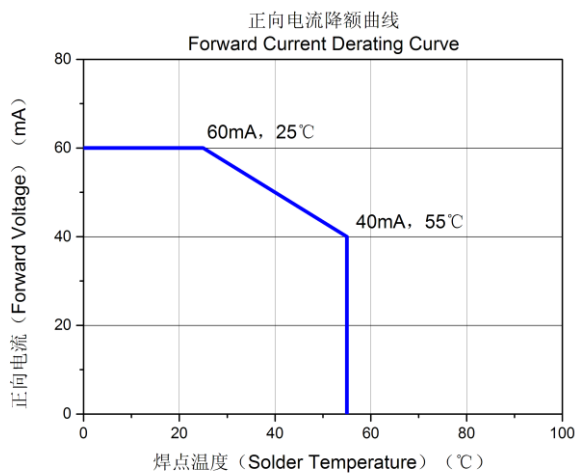
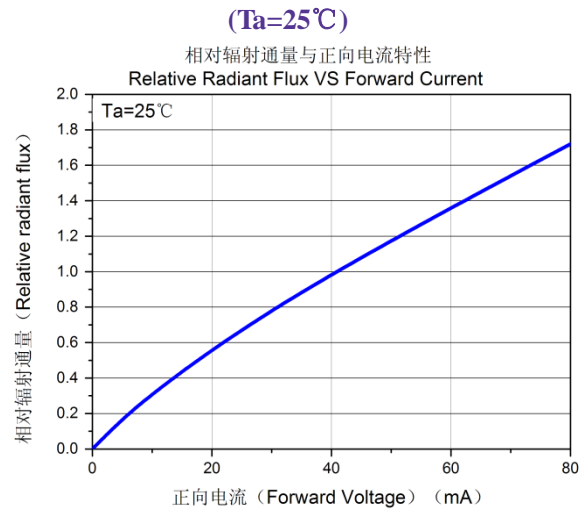
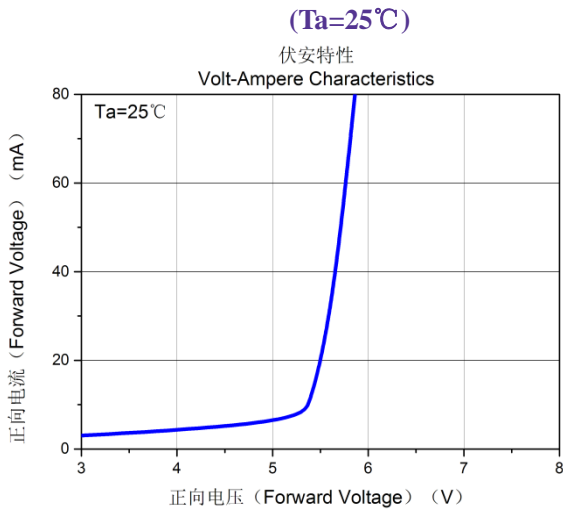

# DATASHEET NPD3535U2

## 3 可靠性试验

### 3 Reliability Test Items And Conditions

实验项目 Test Items	参考标准 Reference	实验条件 Test Conditions	时间 Time Duration	样品数量 Quantity	判据 Criterion
冷热冲击 Thermal Shock	MIL-STD-202G	-40(30min)←→ 100°C(30min)	300 cycles	10	0/10
湿热循环 Temperature And Humidity Cyclic	JEITA ED-4701 200 203	-10°C ~ 65°C , 0% ~ 90%RH 24hrs	10 cycles	10	0/10
高温储存 High Temperature Storage	JEITA ED-4701 100 103	Ta=100°C	1000h	10	0/10
低温储存 Low Temperature Storage	JEITA ED-4701 200 202	Ta=-40°C	1000h	10	0/10
常温寿命试验 Life Test	JESD22-A108D	Ta=25°C , IF =40mA	1000h	5	0/5
耐焊接热 Resistance to Soldering Heat	JEITA ED-4701 300 301	Tsol*=260°C , 10secs	3 times	10	0/10

### 失效判断标准 Criteria For Judging Damage:

测试项目 Test Items	符号 Symbol	测试条件 Test Conditions	判定标准 Criteria For Judging Damage	
			Min	Max
正向电压 Forward Voltage	V <sub>F</sub>	I <sub>F</sub> = 40mA	Initial value *0.9	Initial value *1.1
辐射通量 Radiant Flux	Φ <sub>e</sub>	I <sub>F</sub> =40mA	Initial value *0.7	Initial value *1.1

# DATASHEET NPD3535U2

## 4 外形尺寸

### 4 Outline Dimension

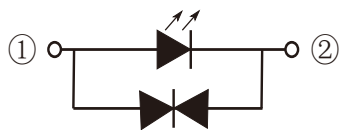
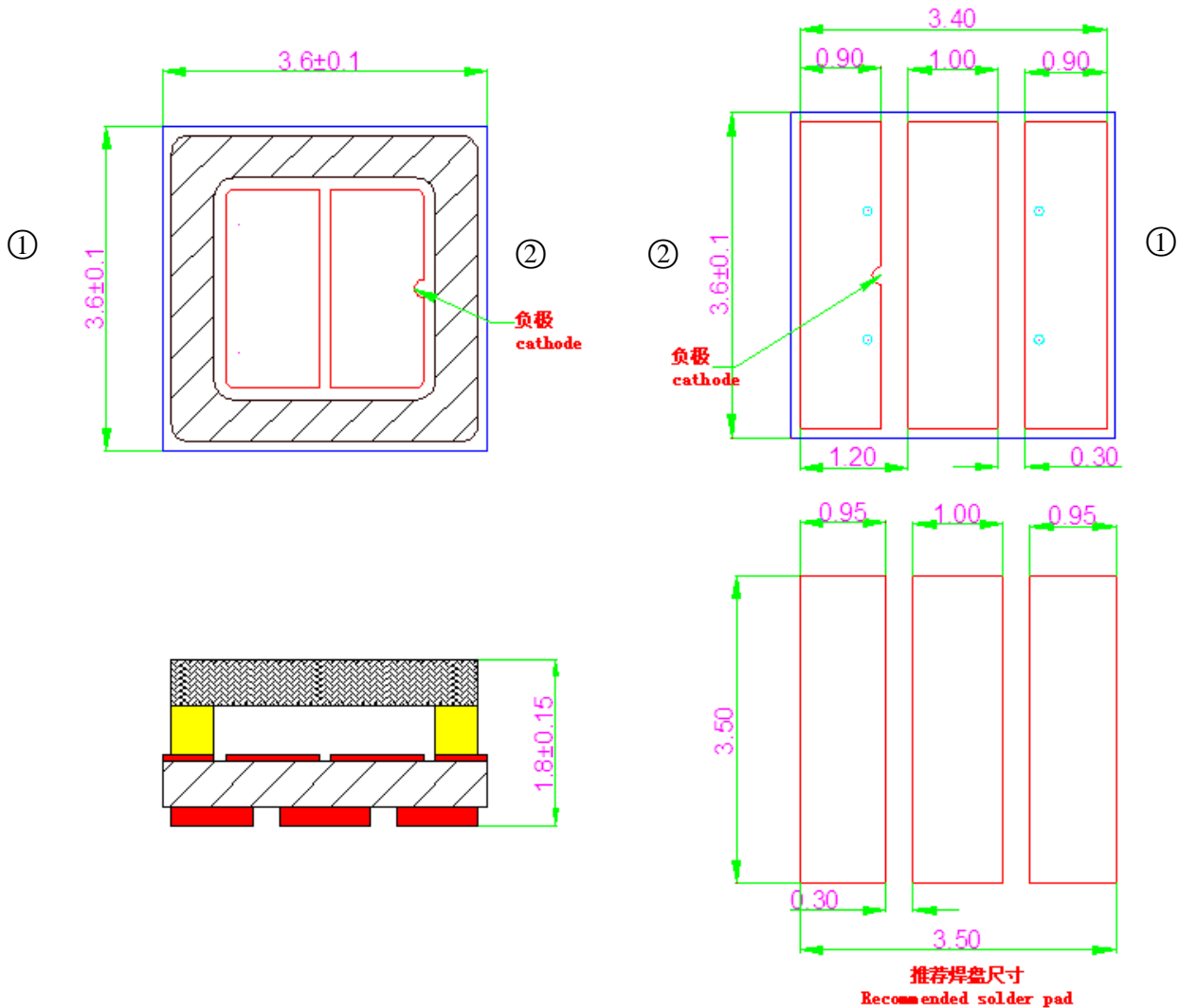

极性 Polarity

①正极 Anode

②负极 Cathode

Note:

A : 缺口标志

A : Nick Mark

单位 : mm , 未注公差 : ±0.15 mm

All dimensions in mm.

Tolerances unless mentioned is ±0.15 mm.

# DATASHEET NPD3535U2

## 5 包装

### 5 Packaging

#### (1) 载带 Carrier Tape

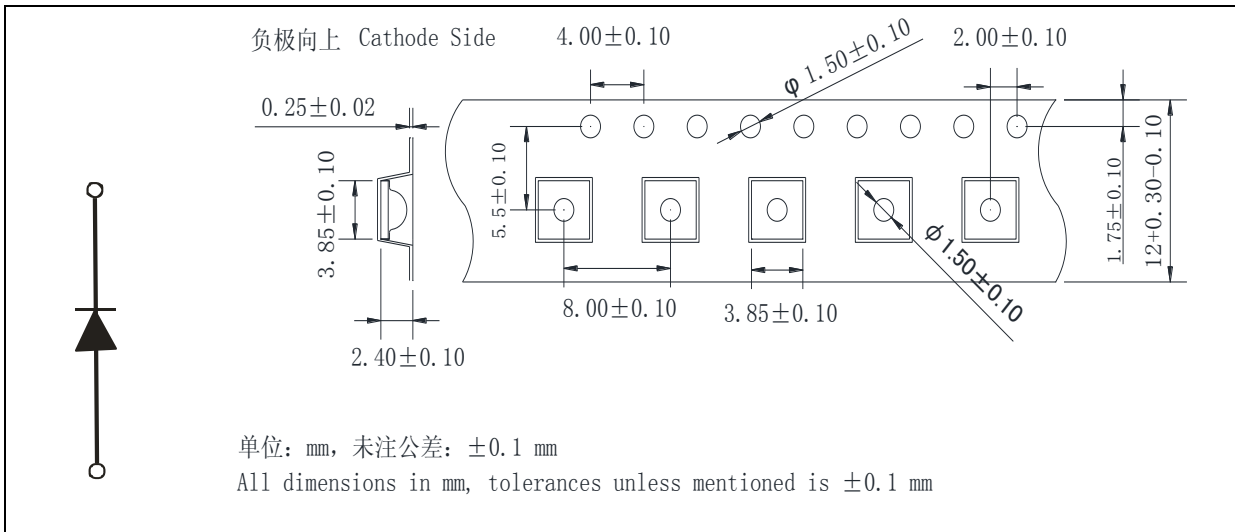

#### (2) 编带细节 Details Of Carrier Tape

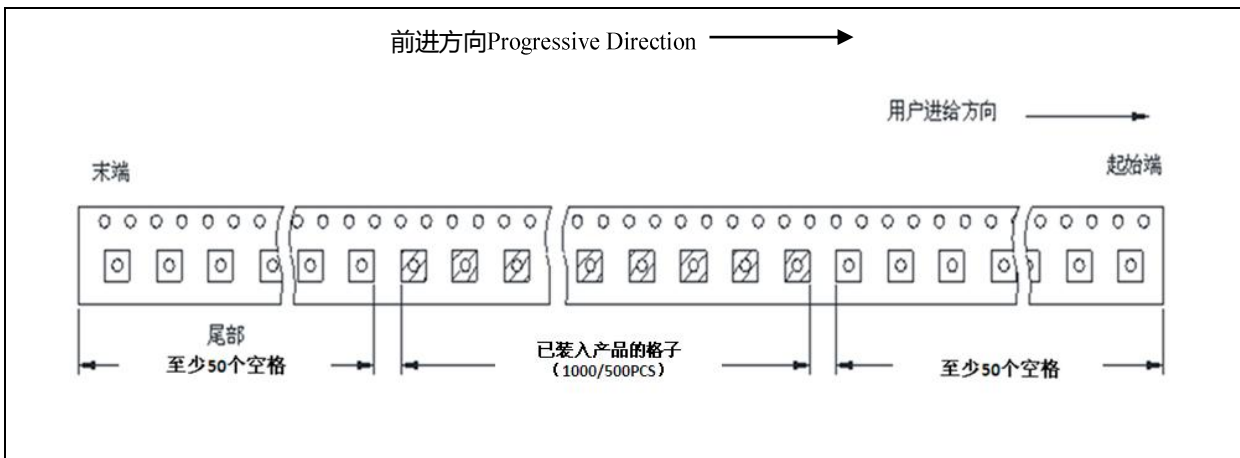

#### (3) 带盘 Reel Dimension

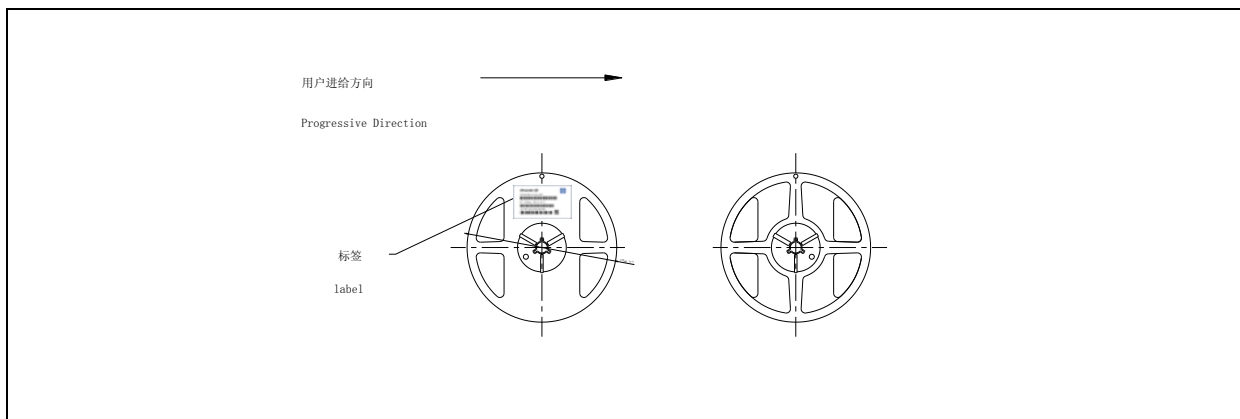



# DATASHEET NPD3535U2

## (4) 防潮防静电包装 Moisture Proof and Anti-Electrostatic Foil Bag

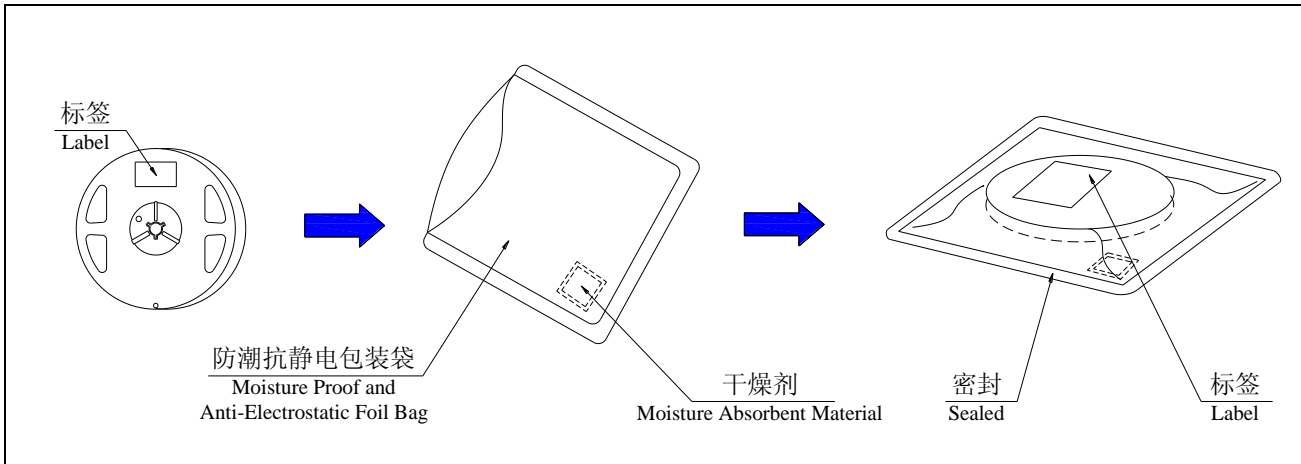

## (5) 外包装箱 Cardboard Box

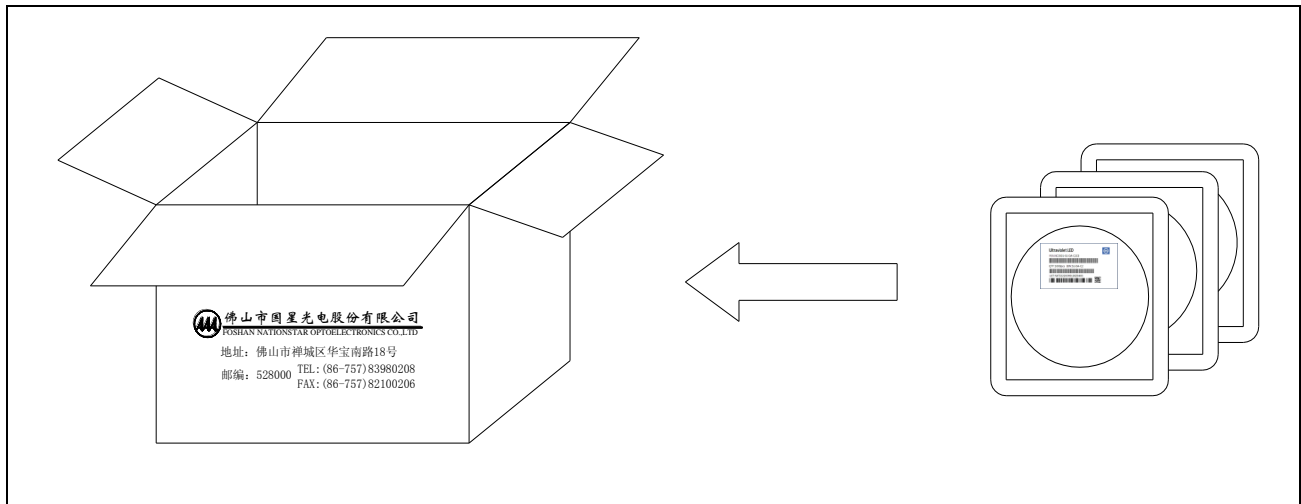

## (6) 标签说明 Label Explanation

TYPE : 产品型号 Product model	 <b>High Power LED</b>	
QTY : 数量 Quantity		
BIN : 分档 Rank	TYPE: _____ IF = _____ mA	
SC : 生产编码 Production code	QTY: _____ PCS	$\lambda_p$ (nm): _____
LOT : 批号 Lot Number	BIN: _____	$\Phi$ (Lm): _____
$\Phi$ ( mW ) : 辐射通量范围 Radiant Flux Range	SC: _____	$\Phi$ (mW): _____
VF : 正向电压范围 Forward Voltage	ITEM CODE: _____	VF(V): _____
IF : 测试电流 Test Current	LOT: _____	QC: _____
$\lambda_p$ : 峰值波长 Peak wavelength	Foshan NationStar Optoelectronics Co.,Ltd 佛山市国星光电股份有限公司	

## 6 焊接指导

### 6 Guideline for Soldering

#### 1. 使用烙铁人手焊接

##### Hand Soldering

推荐使用功率低于 20W 的烙铁，焊接时烙铁的温度必须保持在 360°C 以下，且每个电极只能进行一次焊接，每次焊接的持续时间不得超过 3 秒。

人手焊接过程中的不慎操作易引起 LED 产品的损坏，应当小心谨慎。

A soldering iron of less than 20W is recommended to be used in Hand Soldering. Please keep the temperature of the soldering iron under 360°C while soldering. Each terminal of the LED is to go for less than 3 second and for one time only.

Be careful because the damage of the product is often started at the time of the hand soldering.

#### 2. 回流焊接：推荐使用以下无铅回流焊接温度图进行。

**Reflow Soldering:** Use the conditions shown in the under Figure of Pb-Free Reflow Soldering.

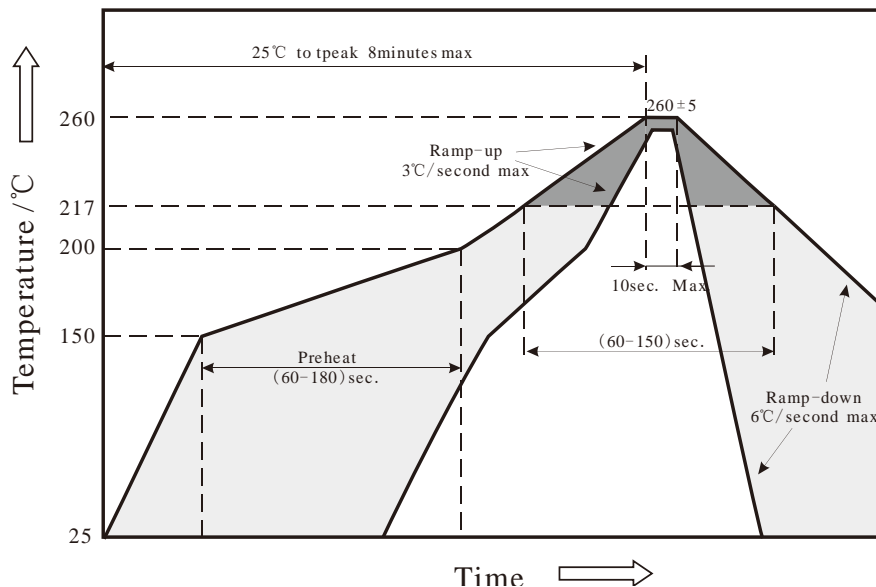

- 回流焊接最多只能进行两次。

Reflow soldering should not be done more than two times.

- 在回流焊接升温过程中，请不要对 LED 施加任何压力。

Stress on the LEDs should be avoided during heating in soldering process.

- 在焊接完成后，待产品温度下降到室温之后，再进行其他处理。

After soldering, do not deal with the product before its temperature drop down to room temperature.

# DATASHEET NPD3535U2

---

## 3. 清洗：

### Cleaning

在焊接后推荐使用酒精进行清洗，在温度不高于 30℃的条件下持续 3 分钟，不高于 50℃的条件下持续 30 秒。使用其他类似溶剂清洗前，请先确认使用的溶剂不会对 LED 的封装和环氧树脂部分造成损伤。

超声波清洗也是有效的方法，一般最大功率不应超过 300W，否则可能对 LED 造成损伤。请根据具体的情况预先测试清洗条件是否会对 LED 造成损伤。

It is recommended that alcohol be used as a solvent for cleaning after soldering. Cleaning is to go under 30°C for 3 minutes or 50°C for 30 seconds. When using other solvents, it should be confirmed beforehand whether the solvents will dissolve the package and the resin or not.

Ultrasonic cleaning is also an effective way for cleaning. But the influence of Ultrasonic cleaning on LED depends on factors such as ultrasonic power. Generally, the ultrasonic power should not be higher than 300W. Before cleaning, a pre-test should be done to confirm whether any damage to LEDs will occur.

\* **注意：**此一般指导原则并不适用于所有 PCB 设计和焊接设备的配置。具体工艺受到诸多因素的影响，请根据特定的PCB设计和焊接设备来确定焊接方案。

\* **Note:** This general guideline may not apply to all PCB designs and configurations of all soldering equipment. The technique in practice is influenced by many factor, it should be specialized base on the PCB designs and configurations of the soldering equipment.

# DATASHEET NPD3535U2

## 7 使用注意事项

### 7 Precautions

#### 1. 贮存：

##### Storage

- 本产品使用密封防潮抗静电袋包装，并附有干燥剂，未开封的产品有一年的保存时间。

Moisture proof and anti-electrostatic package with moisture absorbent material is used, to keep moisture to a minimum.

- 开封前，产品须存放在温度不高于 30℃，湿度不高于 60%RH 的环境中。

Before opening the package, the product should be kept at 30℃ or less and humidity less than 60% RH, and be used within a year.

- 开封后，产品须存放在温度不高于 30℃，湿度不高于 10%RH 的环境中，且应该在 24 小时( 1 天 )内使用完。

建议工作环境为温度不高于 30℃，湿度不高于 60%RH。

After opening the package, the product should be stored at 30℃ or less and humidity less than 10%RH, and be soldered within 24 hours (1 day). It is recommended that the product be operated at the workshop condition of 30℃ or less and humidity less than 60%RH.

- 对于尚未焊接的 LED，如果吸湿剂或包装失效，或者产品没有符合以上有效存储条件，烘焙可以起到一定的性能恢复效果。烘焙条件：( 60±5 ) °C，持续 24 小时。

If the moisture absorbent material has fade away or the LEDs have exceeded the storage time, baking treatment should be performed based on the following condition: (60±5)°C for 24 hours.

#### 2. 静电：

##### Static Electricity

静电和电涌会导致产品特性发生改变，例如正向电压降低等，如果情况严重甚至会损毁产品。所以在使用时必须采取有效的防静电措施。

所有相关的设备和机器都应该正确接地，同时必须采取其他防止静电和电涌的措施。

使用防静电手环，防静电垫子，防静电工作服、工作鞋、手套，防静电容器，都是有效的防止静电和电涌的措施。

Static electricity or surge voltage damages the LEDs. Damaged LEDs will show some unusual characteristic such as the forward voltage becomes lower, or the LEDs do not light at the low current. even not light.

All devices, equipment and machinery must be properly grounded. At the same time, it is recommended that wrist bands or anti-electrostatic gloves, anti-electrostatic containers be used when dealing with the LEDs.

# DATASHEET NPD3535U2

## 3. 硫化：

### Vulcanization

LED 硫化是由于环境中的硫进入支架内部与+1 价的银发生化学反应生成黑色  $\text{Ag}_2\text{S}$  的过程。该过程会导致支架镀银层的反光能力下降，色温漂移和光衰严重，很大程度上影响了产品性能。因此，在使用时应注意采取相应的防硫措施，如避免使用挥发性强的含硫物质，避免接触含硫较高的物质。

LED curing is due to sulfur being in bracket and the +1 price of silver in the chemical reaction generated  $\text{Ag}_2\text{S}$  in the process. It will lead to the capacity of reflecting of silver layer reducing , light color temperature drift and serious decline ,seriously affecting the performance of the product.So we should take corresponding measures to avioding vulcanization, such as to avoid using sulphur volatile substances and keeping away from high sulphur content of the material.

## 4. 眼睛保护忠告：

### Safety Advice For Human Eyes

UV LED 发光时，请勿直视发光光源，特别是对于一些光强较高的 LED，UV LED 光可能伤害你的眼睛。

Do not viewing direct to the light emitting center of the UV LEDs, especially those of great radiant flux will cause great hazard to human eyes. Please be careful.

## 5. 设计建议：

### Design Consideration

设计电路时，通过 LED 的电流不能超过规定的最大值，同时，还需使用保护电阻，否则，微小的电压变化将会引起较大的电流变化，可能导致产品损毁。

建议使用以下 ( A ) 电路，该电路能够很好的调节通过每个 LED 的电流；不推荐使用 ( B ) 电路，该电路在持续的电压驱动下，LED 的正向电压 (  $V_F$  ) 发生变化，电流会随之而发生变化，可能使某些 LED 承受高于规定的电流值。

In designing a circuit, the current through each LED must not exceed the absolute maximum rating specified for each LED. In the meanwhile, resistors for protection should be applied, otherwise slight voltage shift will cause big current change, burn out may happen.

It is recommended to use Circuit A which regulates the current flowing through each LED rather than Circuit B. When driving LEDs with a constant voltage in Circuit B, the current through the LEDs may vary due to the variation in Forward Voltage (  $V_F$  ) of the LEDs. In the worst case, some LED may be subjected to stresses in excess of the Absolute Maximum Rating.

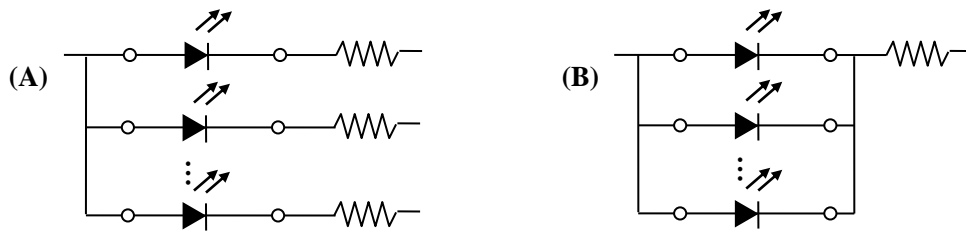

LED 的特性容易因为自身的发热和环境的温度的改变而发生改变。温度的升高会降低 LED 的发光效率、影响发光颜色等，所以在设计时应充分考虑散热的问题。

Thermal Design is paramount importance because heat generation may result in the Characteristics decline, such as brightness decreased, Color changed and so on. Please consider the heat generation of the LEDs when making the system design.

## 6. 其他事项：

### Others

直接用手拿取产品不但会污染封装器件表面，也可能由于静电等因素导致产品性能的改变。过度的压力也可能直接影响封装内部的管芯和金线，因此请勿对产品施加过度压力，特别当产品处于高温状态下，例如在回流焊接过程中。

When handling the product, touching the device surface with bare hands will not only contaminate its surface, but also affect on its optical characteristic. Excessive force to the encapsulant might result in catastrophic failure of the LEDs due to die breakage or wire deformation. For this reason, please do not put excessive stress on LEDs, especially when the LEDs are heated such as during Reflow Soldering.

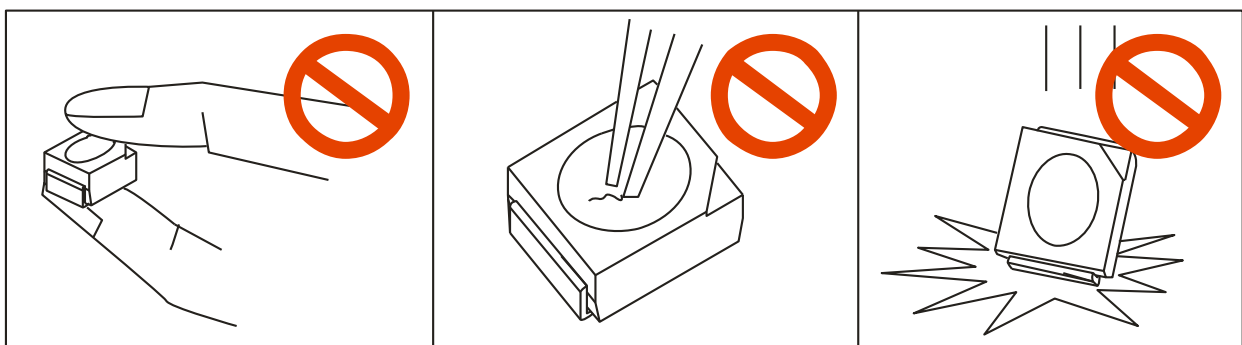

LED 的石英封装部分相当脆弱，请勿用坚硬、尖锐的物体刮、擦玻璃部分。在用镊子夹取的时候也应当小心注意。

The quartz of encapsulant is fragile, so please avoid scratch or friction over the quartz surface. While handling the product with tweezers, do not hold by the quartz, be careful.

# DATASHEET NPD3535U2

## 8 附录：分档标准

### 8 Appendix: Grading Standard

#### 峰值波长 Peak Wavelength ( $I_F=40\text{mA}, T_a=25^\circ\text{C}$ )

Min.	Max.	Unit
270	280	nm

#### 辐射通量 Radiant Flux ( $I_F=40\text{mA}, T_a=25^\circ\text{C}$ )

Min.	Max.	Unit
4	7	mW

#### 正向电压 Forward Voltage ( $I_F=40\text{mA}, T_a=25^\circ\text{C}$ )

Code	Min.	Max.	Unit
C2	5.0	5.5	v
C3	5.5	6.0	v
C4	6.0	6.5	v
C5	6.5	7.0	v

注：1、辐射通量仪器误差±10%，峰值波长仪器误差±3nm，电压仪器误差±0.2V。

Note: 1. Instrumental error of radiation flux ±10%, peak wavelength ±3nm, and voltage ±0.2V.

# DATASHEET NPD3535U2

版本号 Version No.	版本日期 Version data	变更内容 Change content
A0	2021.04.01	初始版本 Initial version
A1	2021.08.10	更新系列版本信息 Update series version information
A2	2022.07.19	更新型号信息 Update model information