

# High Efficiency, Dual Independent 2A Flash LED Driver

## Features

- Dual Independent and Programmable 2A LED Current Source
  - Flash: 3.91mA~2.0A, 256 levels  
7.83mA/level
  - Torch: 0.98mA~500mA, 256 levels  
1.96mA/level
  - Flash Timeout: 40ms~1.6s, 16 levels
  - Flash/Torch/IR Mode
- Up to 85% Flash Efficiency
- Optimized Flash LED Current During Low Battery Conditions (IVFM)
- Hardware Flash/Torch Enable (STROBE/TORCH)
- Synchronization Input for RF Power Amplifier Pulse Events (TX)
- 400kHz I<sup>2</sup>C: AW36515 (I<sup>2</sup>C Address=0x63)
- 0.4mm Pitch, FCQFN-10L Package  
Compatible with AW3643, AW3644, AW36413

## Application

Smartphone Camera Flash

## General Description

The AW36515 is a dual LED flash driver that provides a high level of adjustability within a small solution size. The AW36515 utilizes a 2MHz or 4MHz fixed-frequency synchronous boost converter to provide power to the dual 2A constant current LED sources. The dual 256 levels current sources provide the flexibility to adjust the current of LED1 and LED2 in Flash/Torch/IR modes. The AW36515 provides IVFM protection to prevent system reset or shutdown under low battery condition.

The AW36515 are controlled via an I<sup>2</sup>C - compatible interface. The main features of the AW36515 include: flash/torch current, flash timeout duration, IVFM and TX interrupt. The AW36515 also provides hardware flash/torch pin (STROBE/TORCH) to control Flash/Torch events.

The 2MHz or 4MHz switching frequency options, overvoltage protection (OVP), and adjustable current limit allow for the use of tiny, low-profile inductors and 10- $\mu$ F ceramic capacitors. The device operates over a -40°C to +85°C ambient temperature range.

The AW36515 is available in small 0.4mm pitch FCQFN 1.6mm $\times$ 1.2mm -10L package.

## Typical Application Circuit

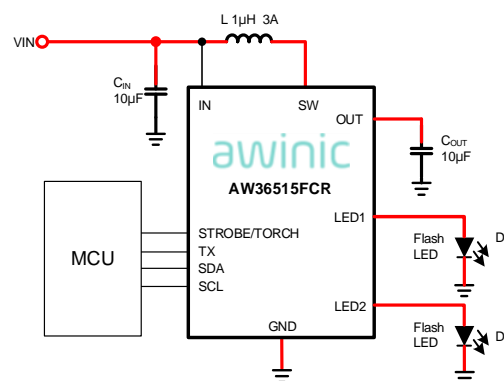

Typical Application Circuit of AW36515

## Pin Configuration And Top Mark

AW36515FCR Pin Configuration  
(Top View)

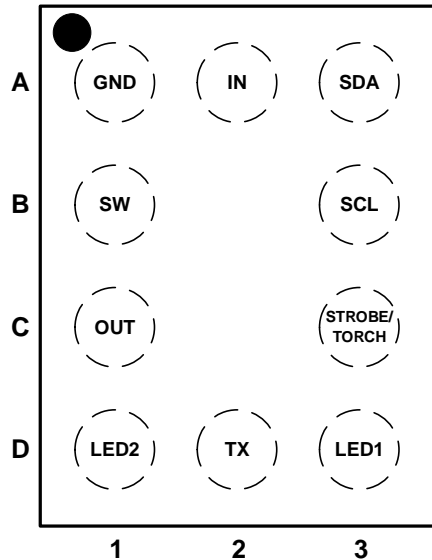

AW36515FCR Top Mark  
(Top View)

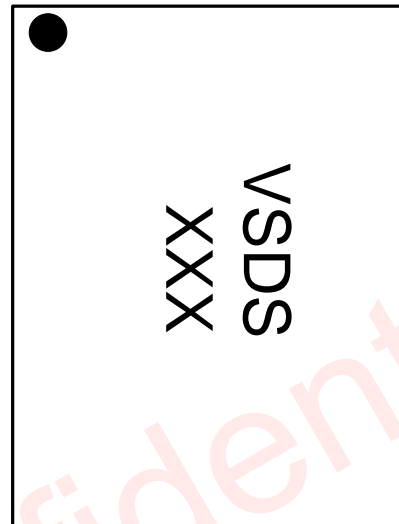

VSDS – AW36515FCR

XXX – Production Tracing Code

### Pin Configuration and Top Mark

## Pin Definition

No.	NAME	TYPE	DESCRIPTION
A1	GND	Ground	Ground
A2	IN	Power	Input voltage connection. Connect IN to GND with a 10μF or larger ceramic capacitor.
A3	SDA	I/O	Serial data input/output of the I <sup>2</sup> C interface.
B1	SW	Power	Switch pin of the step-up DC-DC convertor.
B3	SCL	I/O	Serial clock input of the I <sup>2</sup> C interface.
C1	OUT	Power	Step-up DC-DC converter output. Connect a 10μF ceramic capacitor between OUT and GND.
C3	STROBE/TORCH	I/O	Active high hardware flash/torch/IR enable. Drive STROBE/TORCH high to turn on Flash/Torch/IR pulse. Internal pull down resistor of 300kΩ between STROBE/TORCH and GND.
D1	LED2	Power	High-side current source output for flash LED2.
D2	TX	I/O	Power amplifier synchronization input. Internal pull down resistor of 300kΩ between TX and GND.
D3	LED1	Power	High-side current source output for flash LED1.

## Ordering Information

Part Number	Temperature	Package	Marking	Moisture Sensitivity Level	Environmental Information	Delivery Form
AW36515FCR	-40°C~85°C	FCQFN 1.6mmX1.2mm -10L	VSDS	MSL1	ROHS+HF	3000 units/ Tape and Reel

## AWINIC Flash LED Driver Series

Product	Channels	Type	Description	Package
AW36515	2	Boost	High Efficiency, Dual Independent 2A Flash LED Driver	FCQFN-10L
AW3644	2	Boost	High Efficiency, Dual Independent 1.5A Flash LED Driver	CSP-12B
AW3643	2	Boost	High Efficiency, Dual 1.5A Flash LED Driver	CSP-12B
AW36413	2	Boost	High Efficiency, Dual 1.5A Flash LED Driver	CSP-12B
AW3648	1	Boost	High Efficiency, 1.5A Flash LED Driver	CSP-12B
AW3642	1	Boost	High Efficiency, 1.5A Flash LED Driver	CSP-9B
AW3641E	1	Charge Pump	Flash Current & Flash Timer Programmable 1A Flash LED Driver	DFN-10L
AW36402	1	Current Sink	200mA 1-wire Configurable Front Flash LED Driver with Ultra Small Package	DFN-6L
AW36404	1	Current Sink	400mA 1-wire Configurable Front Flash LED Driver with Ultra Small Package	DFN-8L
AW36406	1	Current Sink	600mA PWM Configurable Front Flash LED Driver with Ultra Small Package	DFN-8L

## Typical Application Circuits

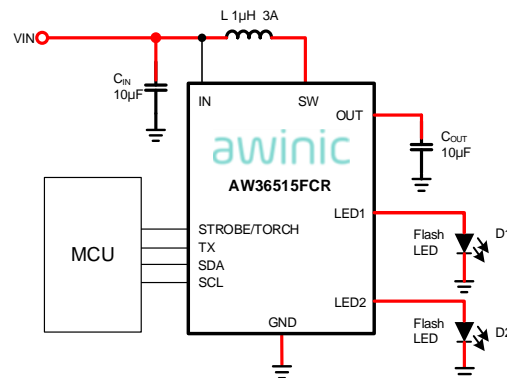

AW36515 Application Circuit

### Notice for Typical Application Circuits:

- 1: Please place  $C_{IN}$ ,  $C_{OUT}$  as close to the chip as possible.
- 2: Connect the inductor on the top layer close to the SW pin.
- 3: For the sake of driving capability, the power lines, output lines, and the connection lines of L and LED should be short and wide as possible.
- 4: Traces carry high current are marked in red in the above figure.

**Absolute Maximum Ratings**<sup>(NOTE1)</sup>

PARAMETERS		Range	Unit
IN, SW, OUT, LED1, LED2		-0.3 to 6	V
SCL, SDA, STROBE/TORCH, TX		-0.3 to (VIN+0.3)	V
Continuous power dissipation		Internally limited	
Max Junction Temperature T <sub>JMAX</sub>		155	°C
Storage Temperature T <sub>STG</sub>		-65 to 150	°C
Maximum lead temperature (soldering)		260	°C
Junction to Ambient Thermal Resistance $\theta_{JA}$		92	°C /W
ESD, All Pins <sup>(NOTE2)</sup>	HBM	±2000	V
	CDM	±1500	V
Latch-Up (Test method: JEDEC STANDARD NO.78D)		+IT: +200 -IT: -200	mA

**Recommended Operating Conditions**

PARAMETERS	Range	Unit
V <sub>IN</sub>	2.7 to 5.5	V
Junction temperature (T <sub>J</sub> )	-40 to 125	°C
Ambient temperature (T <sub>A</sub> )	-40 to 85	°C

*NOTE1: Conditions out of those ranges listed in "absolute maximum ratings" may cause permanent damages to the device. In spite of the limits above, functional operation conditions of the device should within the ranges listed in "recommended operating conditions". Exposure to absolute-maximum-rated conditions for prolonged periods may affect device reliability.*

*NOTE2: The human body model is a 100pF capacitor discharged through a 1.5kΩ resistor into each pin. Test method: ANSI/ESDA/JEDEC JS-001. CDM test method: JEDEC22-C101E.*

## Electrical Characteristics

Typical values tested at  $T_A=25^{\circ}\text{C}$ . Minimum and maximum limits apply over the full operating ambient temperature range ( $-40^{\circ}\text{C}\leq T_A\leq 85^{\circ}\text{C}$ ). Unless otherwise specified,  $V_{IN}=3.6\text{V}$ .

Symbol	Description	Test Condition	Min	Typ	Max	Unit
<b>Vin Supply</b>						
$V_{IN}$	Input operating range		2.7		5.5	V
$I_Q$	Quiescent supply current	Device not switching, pass mode		0.4	0.8	mA
$I_{SB}$	Standby supply current	Device disabled, $2.7\text{V}\leq V_{IN}\leq 5.5\text{V}, \text{SCL}=\text{SDA}=0\text{V}$		3	10	$\mu\text{A}$
UVLO	Under voltage lockout threshold	Falling $V_{IN}$		2.5		V
		Rising $V_{IN}$		2.6		V
<b>Current Source Specifications</b>						
$I_{LED1/2}$	Current source accuracy	$V_{OUT}=4\text{V}$ , flash code=0xFF=2.0A	-7%	2.0	7%	A
		$V_{OUT}=4\text{V}$ , torch code=0x7F=249mA	-10%	249	10%	mA
$V_{OVP}$	$V_{OUT}$ over-voltage protect threshold	ON threshold	4.85	5	5.15	V
		OFF threshold	4.75	4.9	5.05	
<b>Boost Converter Specifications</b>						
$R_{PMOS}$	PMOS switch on-resistance			90		m $\Omega$
$R_{NMOS}$	NMOS switch on-resistance			70		m $\Omega$
$I_{CL}$	Switch current limit	Reg 0x07, bit[0]=0	-12%	1.9	12%	A
		Reg 0x07, bit[0]=1	-12%	2.8	12%	
$F_{SW}$	Switching frequency	Reg 0x07, bit[1]=0	-6%	2	6%	MHz
		Reg 0x07, bit[1]=1	-6%	4	6%	
$V_{IVFM}$	Input voltage flash monitor trip threshold	Reg 0x02, bits[5:3]="000"	-3%	2.9	3%	V
$T_{SD}$	Thermal shutdown threshold			155		$^{\circ}\text{C}$
	Thermal shutdown hysteresis			20		

**Electrical Characteristics(continued)**

Typical values tested at  $T_A=25^{\circ}\text{C}$ . Minimum and maximum limits apply over the full operating ambient temperature range( $-40^{\circ}\text{C}\leq T_A\leq 85^{\circ}\text{C}$ ). Unless otherwise specified,  $V_{IN}=3.6\text{V}$ .

Symbol	Description	Test Condition	Min	Typ	Max	Unit
<b>I<sup>2</sup>C-Compatible Interface Specifications(SCL,SDA)</b>						
$V_{IL}$	Input logic low		0		0.4	V
$V_{IH}$	Input logic high		1.2		$V_{IN}$	V
$V_{OL}$	Output logic low	$I_{LOAD}=3\text{mA}$			0.4	V
<b>STROBE/TORCH, TX Voltage Specifications</b>						
$V_{IL}$	Input logic low		0		0.4	V
$V_{IH}$	Input logic high		1.2		$V_{IN}$	V
$R_{PD}$	Internal pull down resistors			300		k $\Omega$

## I<sup>2</sup>C Interface Timing

Symbol	Description	Min	Typ	Max	Units
F <sub>SCL</sub>	Interface Clock frequency			400	kHz
T <sub>DEGLITCH</sub>	Deglitch time	SCL	200		ns
		SDA	250		ns
T <sub>HD:STA</sub>	(Repeat-start) Start condition hold time	0.6			μs
T <sub>LOW</sub>	Low level width of SCL	1.3			μs
T <sub>HIGH</sub>	High level width of SCL	0.6			μs
T <sub>SU:STA</sub>	(Repeat-start) Start condition setup time	0.6			μs
T <sub>HD:DAT</sub>	Data hold time	0			μs
T <sub>SU:DAT</sub>	Data setup time	0.1			μs
T <sub>R</sub>	Rising time of SDA and SCL			0.3	μs
T <sub>F</sub>	Falling time of SDA and SCL			0.3	μs
T <sub>SU:STO</sub>	Stop condition setup time	0.6			μs
T <sub>BUF</sub>	Time between start and stop condition	1.3			μs

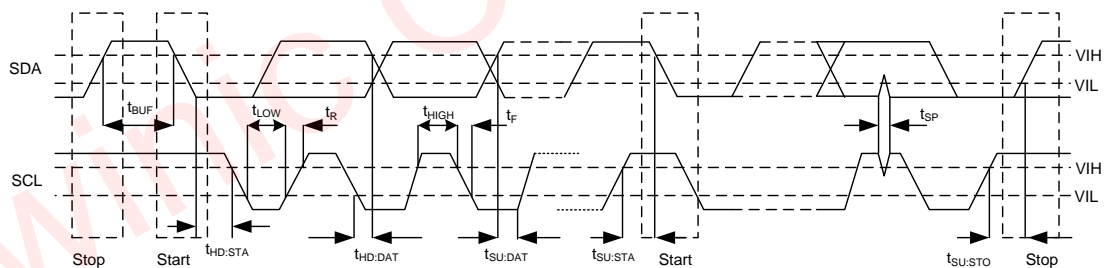

I<sup>2</sup>C INTERFACE TIMING



## Typical Characteristics

Ambient temperature is 25°C, input voltage is 3.6 V,  $C_{IN} = C_{OUT} = 2 \times 10 \mu F$  and  $L=1 \mu H$ , unless otherwise noted .

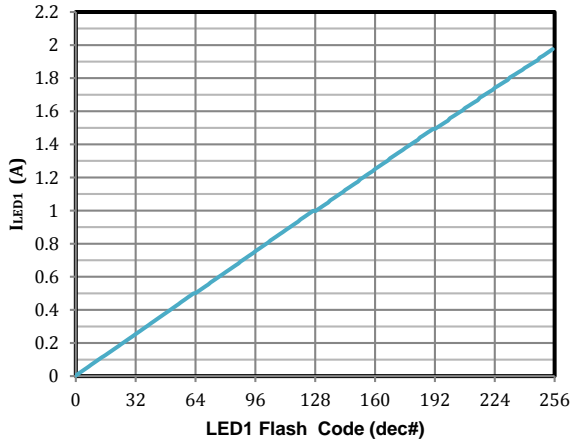

LED1 Flash Current vs Brightness Code

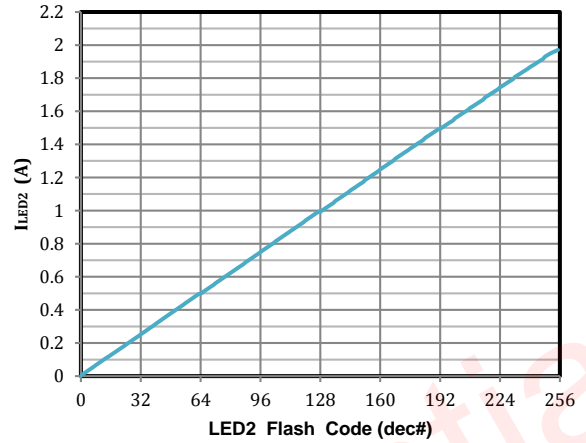

LED2 Flash Current vs Brightness Code

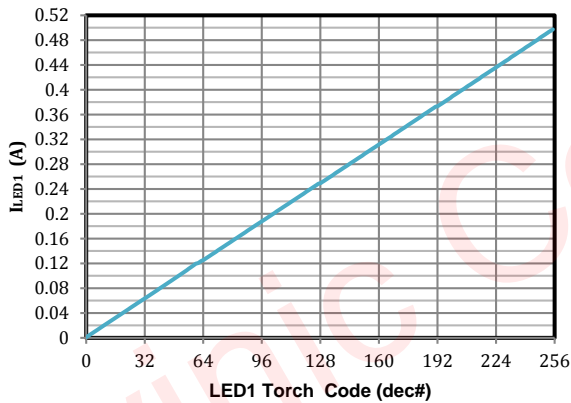

LED1 Torch Current vs Brightness Code

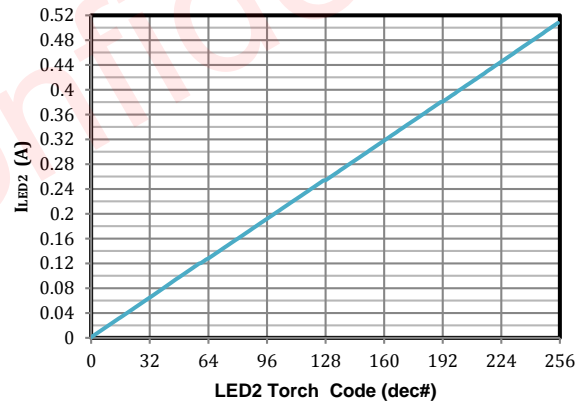

LED2 Torch Current vs Brightness Code

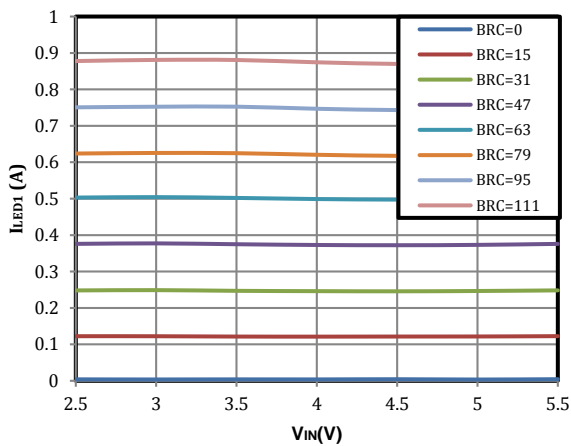

LED1 Flash Current vs Input Voltage

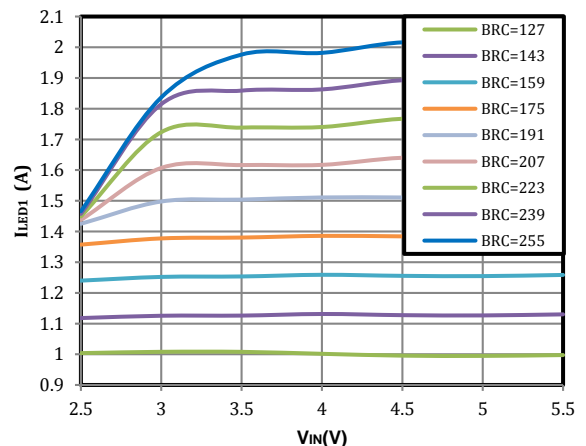

LED1 Flash Current vs Input Voltage

### Typical Characteristics (continued)

Ambient temperature is 25°C, input voltage is 3.6 V,  $C_{IN} = C_{OUT} = 2 \times 10 \mu F$  and  $L=1 \mu H$ , unless otherwise noted .

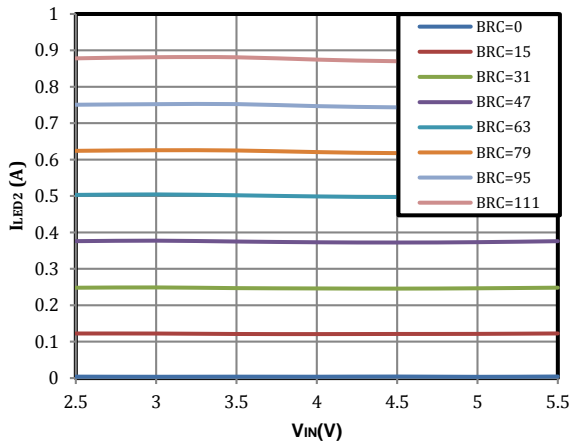

LED2 Flash Current vs Input Voltage

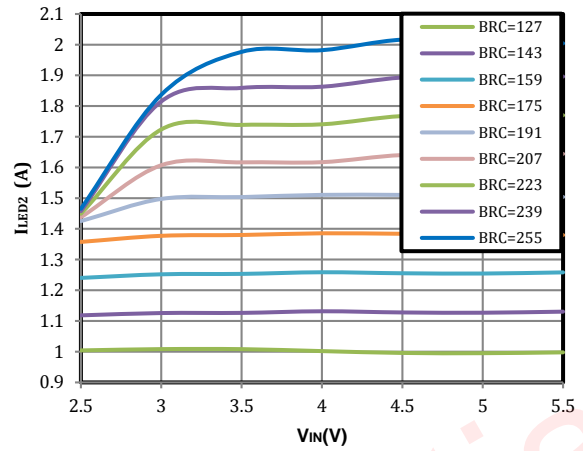

LED2 Flash Current vs Input Voltage

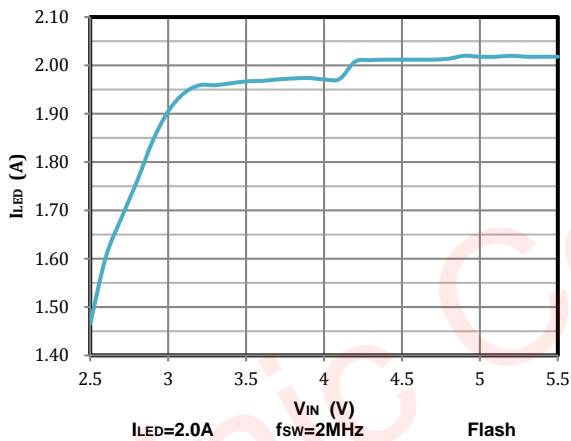

LED1/2 Flash Current vs Input Voltage

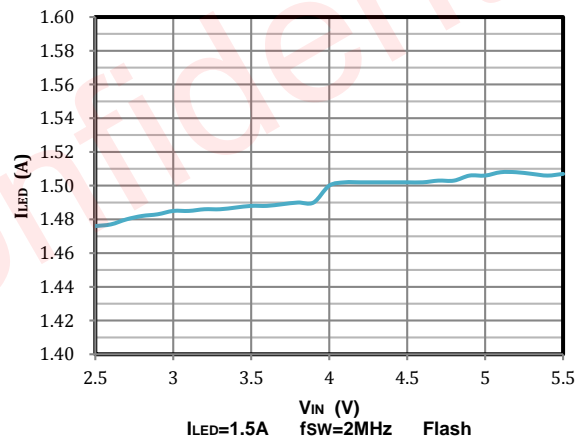

LED1/2 Flash Current vs Input Voltage

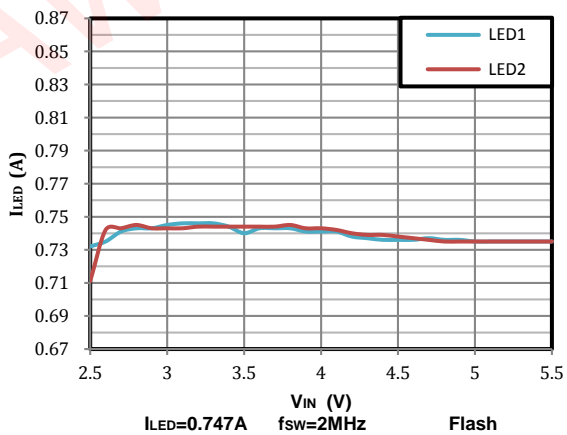

LED1 & LED2 Current vs Input Voltage

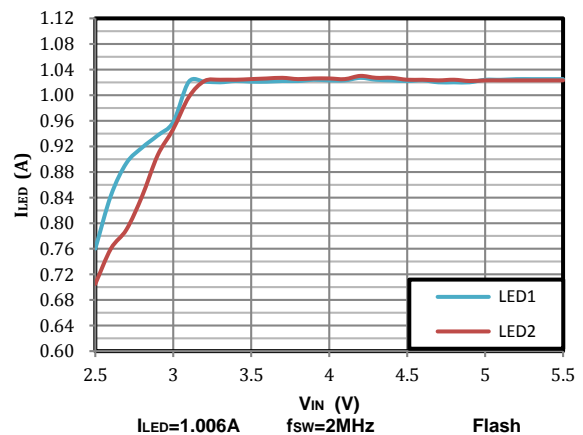

LED1 & LED2 Current vs Input Voltage

### Typical Characteristics (continued)

Ambient temperature is 25°C, input voltage is 3.6 V,  $C_{IN} = C_{OUT} = 2 \times 10 \mu F$  and  $L=1 \mu H$ , unless otherwise noted .

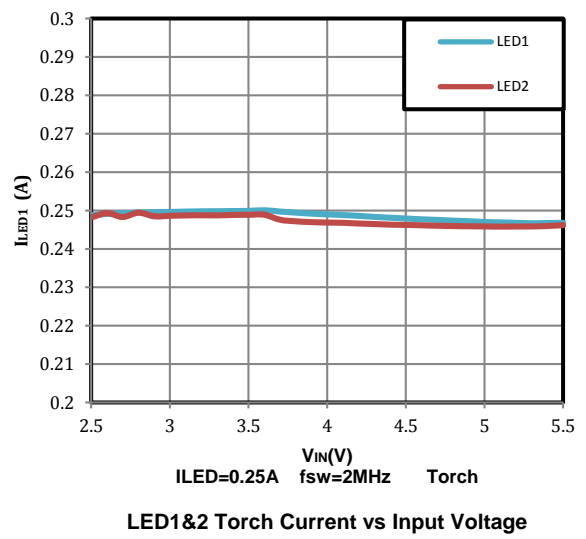
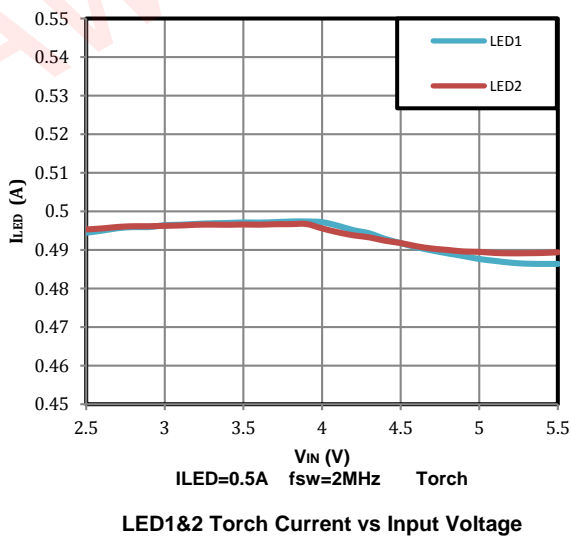
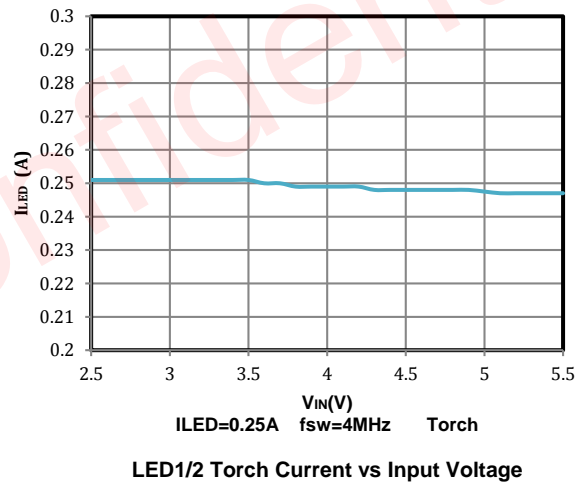
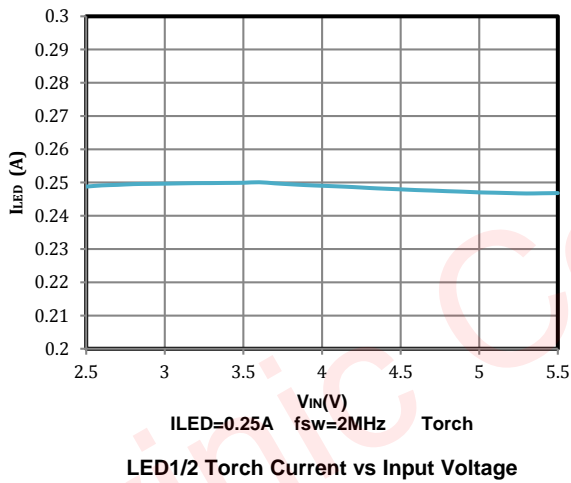
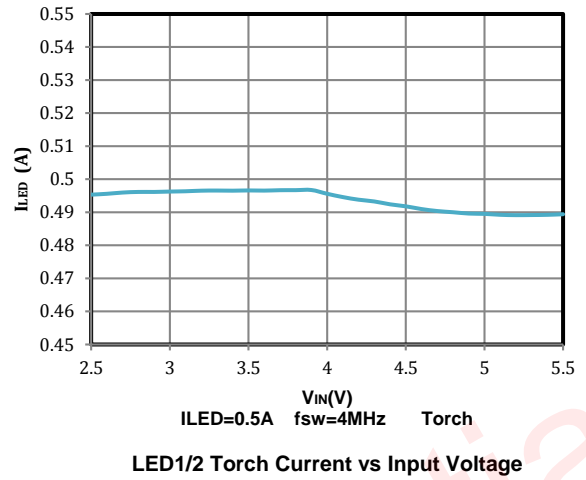
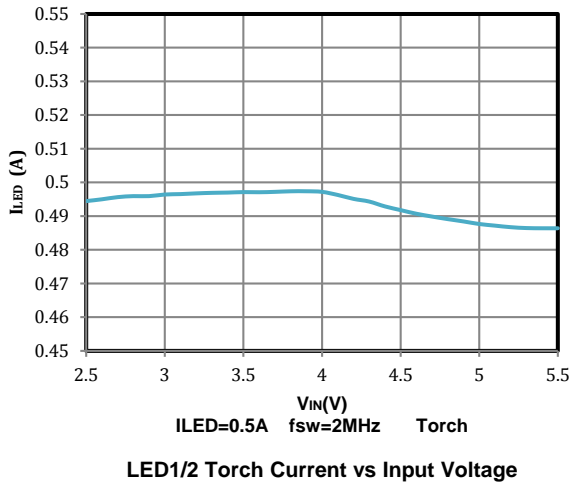

### Typical Characteristics (continued)

Ambient temperature is 25°C, input voltage is 3.6 V,  $C_{IN} = C_{OUT} = 2 \times 10 \mu F$  and  $L=1 \mu H$ , unless otherwise noted .

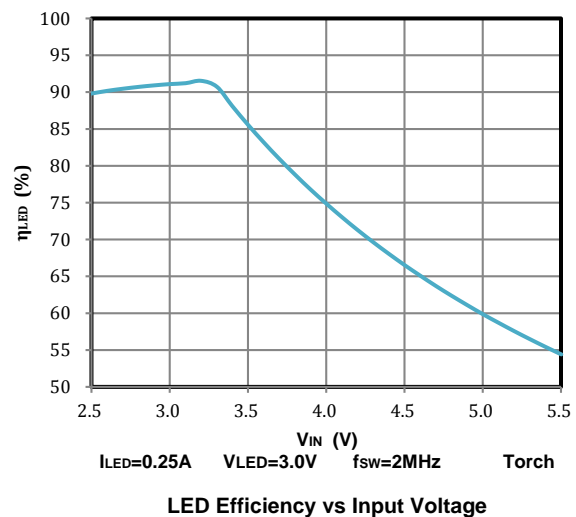
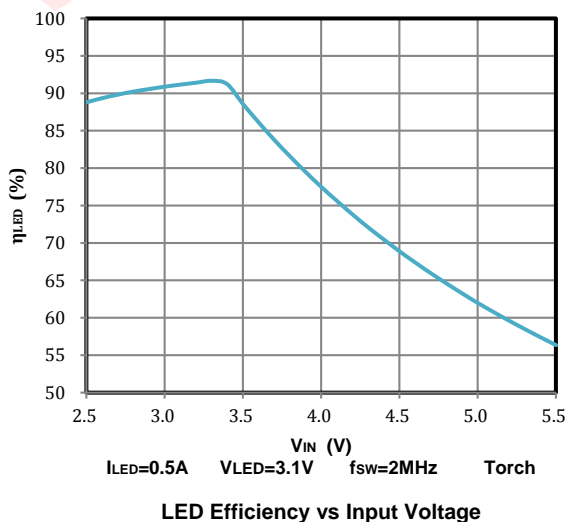
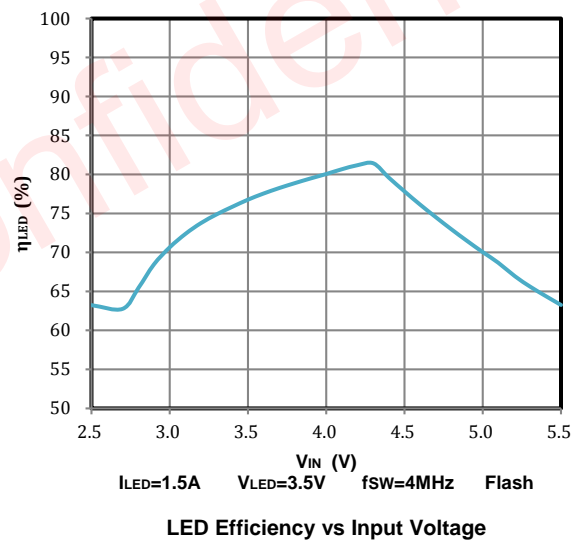
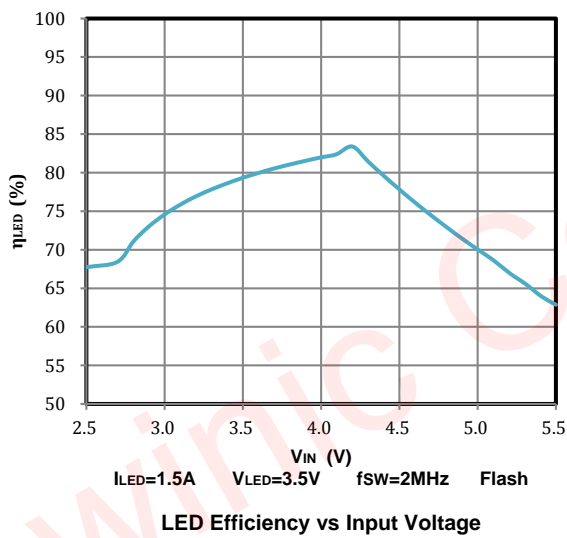
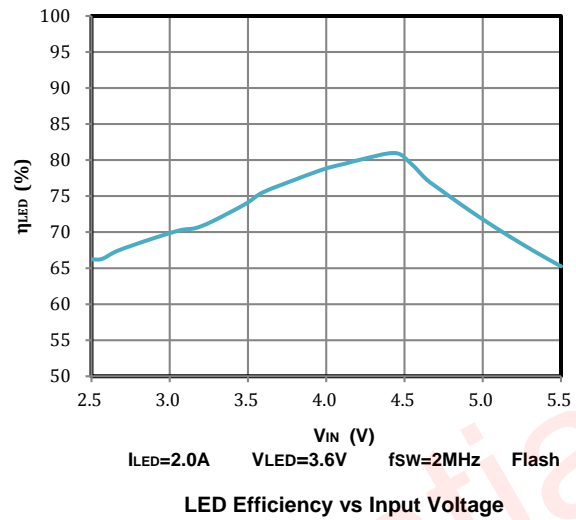
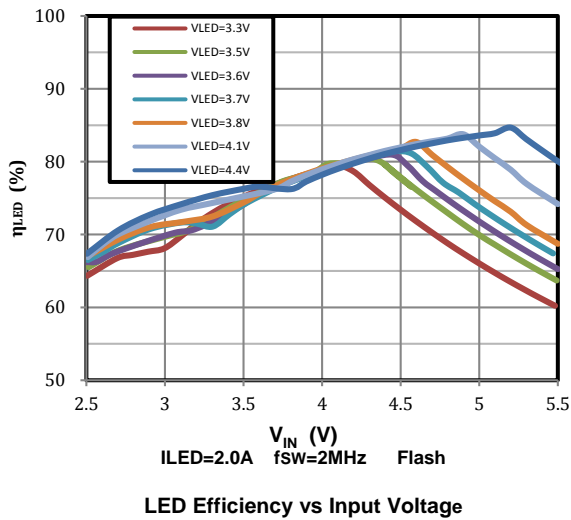

## Typical Characteristics (continued)

Ambient temperature is 25°C, input voltage is 3.6 V,  $C_{IN} = C_{OUT} = 2 \times 10 \mu F$  and  $L=1 \mu H$ , unless otherwise noted .

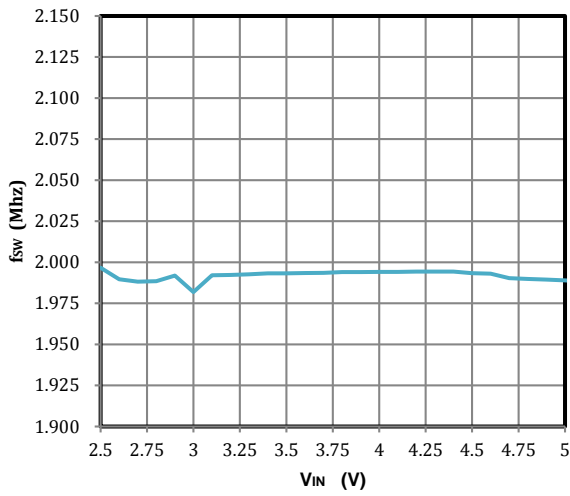

2-MHz Frequency vs Input Voltage

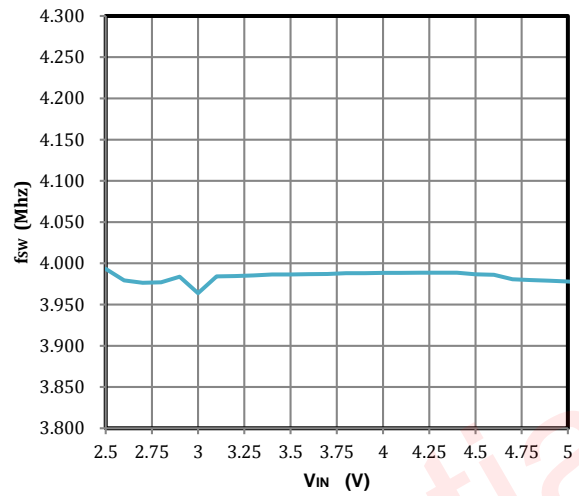

4-MHz Frequency vs Input Voltage

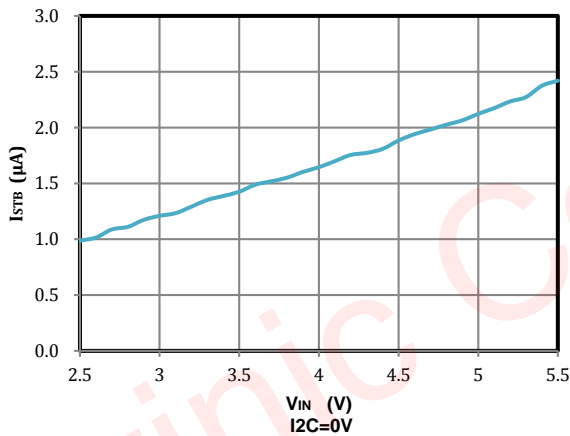

Standby Current vs Input Voltage

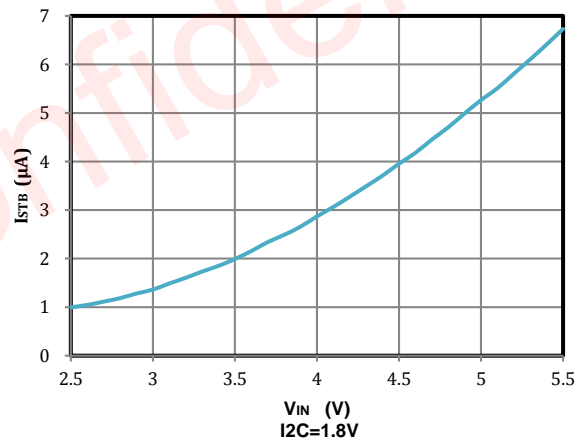

Standby Current vs Input Voltage

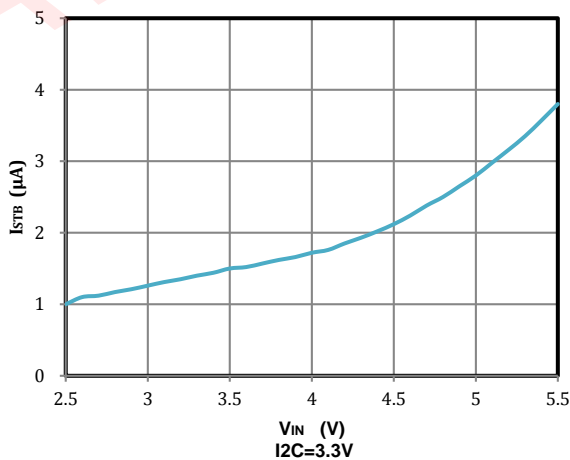

Standby Current vs Input Voltage

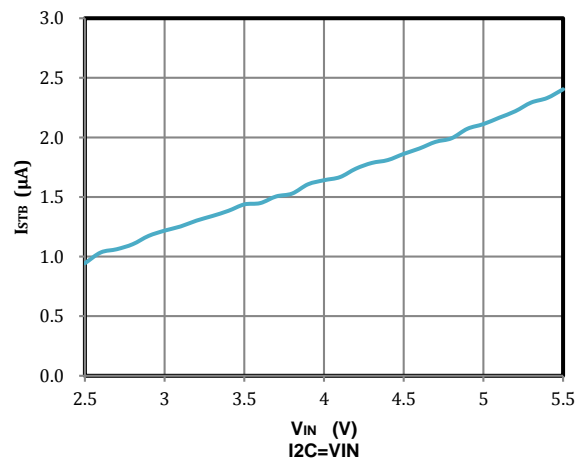

Standby Current vs Input Voltage

### Typical Characteristics (continued)

Ambient temperature is 25°C, input voltage is 3.6 V,  $C_{IN} = C_{OUT} = 2 \times 10 \mu F$  and  $L=1 \mu H$ , unless otherwise noted .

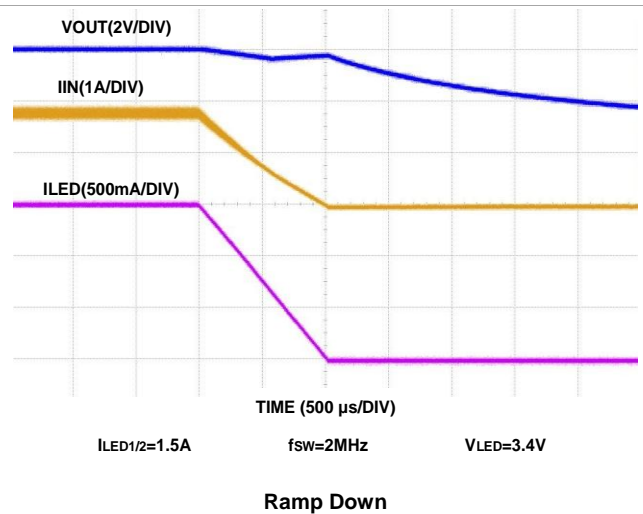
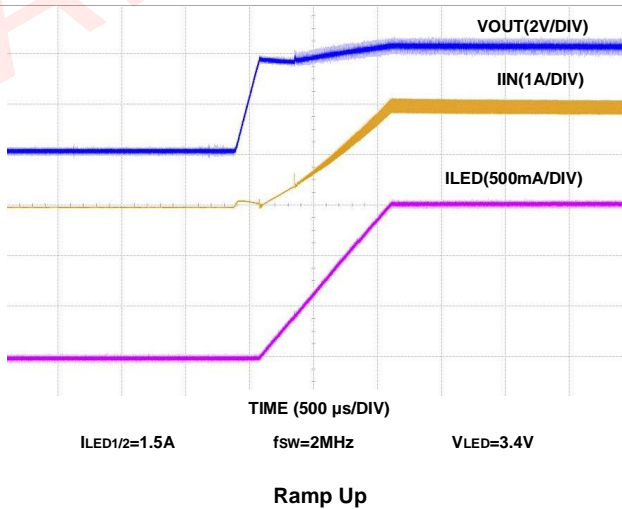
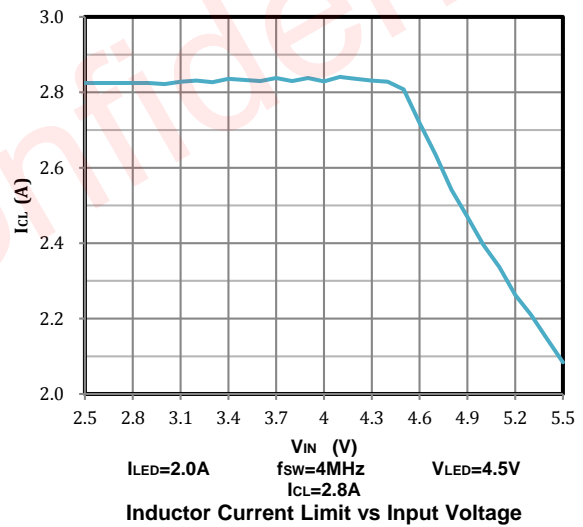
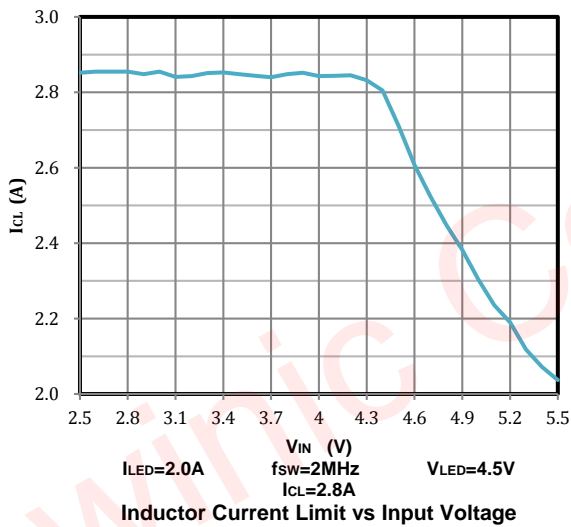
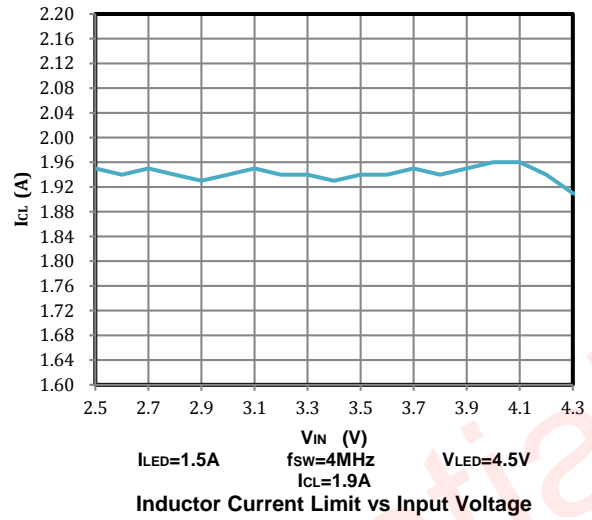
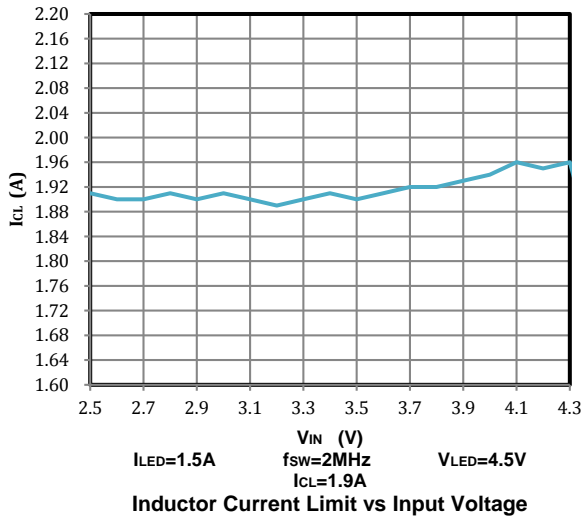

### Typical Characteristics (continued)

Ambient temperature is 25°C, input voltage is 3.6 V,  $C_{IN} = C_{OUT} = 2 \times 10 \mu F$  and  $L = 1 \mu H$ , unless otherwise noted .

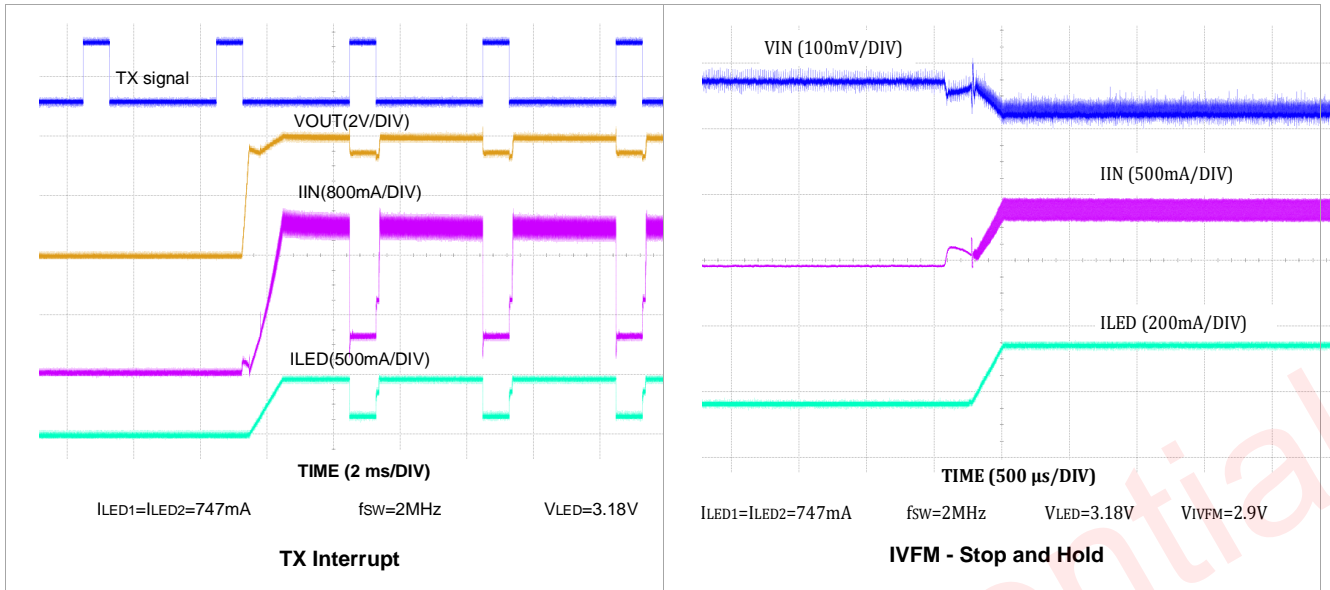

## Detailed Functional Description

The AW36515 is a high-power LED flash driver capable of delivering up to 2A in either of the two parallel LEDs. The device incorporates a 2MHz or 4MHz constant frequency-synchronous current-mode PWM boost converter and dual high-side current sources to regulate the LED current over the 2.7V to 5.5V input voltage range.

The AW36515 PWM DC-DC boost converter switches and boosts the output to maintain at least  $V_{HR}$  across each of the current sources (LED1/2). This minimum headroom voltage ensures that both current sources remain in regulation. If the input voltage is above the LED voltage + current source headroom voltage, the device would not switch, but turn the PMOS on continuously (Pass mode). In Pass mode the difference between  $(V_{IN} - I_{LED} \times R_{PMOS})$  and the voltage across the LED is dropped across the current source.

The AW36515 has two logic inputs including a reusable hardware Flash/Torch Enable (STROBE/TORCH) and a Flash Interrupt input (TX) designed to interrupt the flash pulse during high battery-current conditions. These logic inputs have internal 300k $\Omega$  (typical) pull-down resistors to GND.

Control is done via an I<sup>2</sup>C-compatible interface. This includes adjustment of the Flash and Torch current levels, changing the Flash Timeout Duration, and changing the switch current limit. Additionally, there are flag and status bits that indicate flash current timeout, LED over-temperature condition, LED failure (open/short), device thermal shutdown, TX interrupt, and  $V_{IN}$  under-voltage conditions.



## Functional Block Diagram

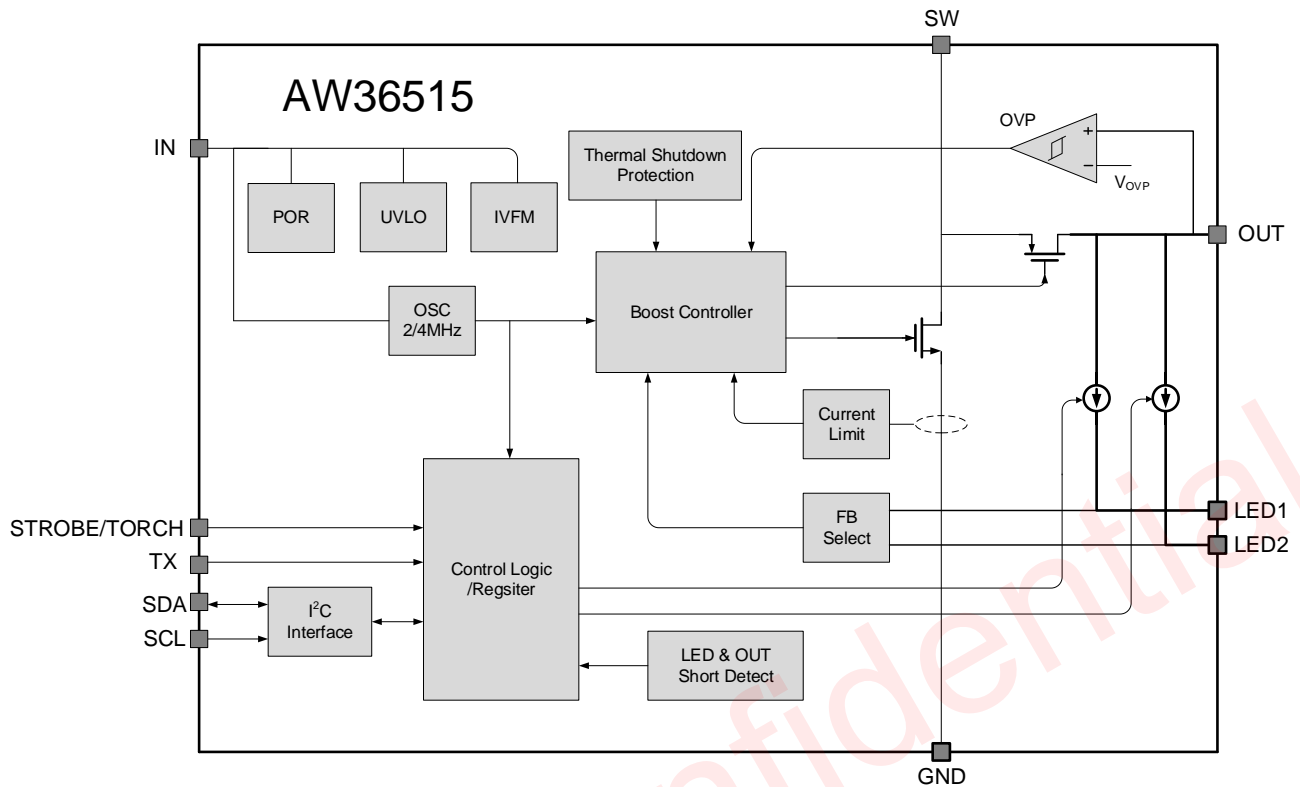

## Features Description

### Power On Reset

When the supply voltage  $V_{IN}$  drops below a predefined voltage  $V_{POR}$  (2.0V typical), the device generates a reset signal to perform a power-on reset operation, which will reset all control circuits and configuration registers.

Once  $V_{IN}$  goes above around  $V_{POR}$  (2.0V typical), it should stay high for at least 2ms time before any I<sup>2</sup>C command can be accepted.

### Software Reset

By setting bit[7](Software Reset Bit) to a '1' in the Boost Configuration Register(0x07) via I<sup>2</sup>C interface will reset the AW36515 internal circuit and all configuration registers, after the soft reset command is input through I<sup>2</sup>C, it needs to wait at least 2ms before any other I<sup>2</sup>C command can be accepted.

### Flash Mode

In Flash Mode, the LED current sources (LED1/2) provide 256 target current levels from 3.91mA to 2A. The Flash currents are adjusted via the LED1 and LED2 Flash Brightness Registers. Flash mode is activated by the Enable Register(setting M1, M0 to '11'), or by pulling the STROBE/TORCH pin HIGH when bit[5] (Strobe Enable Bit) is '1' in the Enable Register(0x01). Once the Flash sequence is activated the current source (LED1/2) ramps up to the programmed Flash current by stepping through all current steps until the programmed current is reached.

When the device is enabled in Flash Mode through the Enable Register, all mode bits in the Enable Register are cleared after a flash timeout event.

**Torch Mode**

In Torch mode, the LED current sources (LED1/2) provide 256 target current levels from 0.98mA to 500mA on AW36515. The Torch currents are adjusted via the LED1 and LED2 Torch Brightness Registers. Torch mode is activated by the Enable Register (setting M1, M0 to '10'), or by pulling the STROBE/TORCH pin HIGH when bit[5] (Torch Enable Bit) is '1' in the Enable Register(0x01). Once the TORCH sequence is activated the active current sources (LED1/2) ramps up to the programmed Torch current by stepping through all current steps until the programmed current is reached. The rate at which the current ramps is determined by the value chosen in the Timing Register.

AW36515 will execute flash operation when both bit[4] and bit[5] are '1' in the Enable Register with pulling the STROBE/TORCH pin HIGH.

Torch Mode is not affected by Flash Timeout or by a TX Interrupt event.

**IR Mode**

In IR Mode, Enable register bit[3:2] should be to '01' (setting M1, M0 to '01') and the STROBE/TORCH pin should be enabled(Strobe Enable Bit). The target LED current is equal to the value stored in the LED1/2 Flash Brightness Registers. When IR mode is enabled, the boost converter turns on and set the output equal to the input (pass-mode) . The STROBE/TORCH pin can only be set to be Level sensitive, meaning all timing of the IR pulse is externally controlled, but it is still protected by flash time-out if STROBE width is too long. In IR Mode, the current sources do not ramp the LED outputs to the target. LED1/2 is enabled to the full current setting without delay or slow ramp during STROBE rising edge, and they are fully turned off immediately without delay or slow ramp during STROBE falling edge

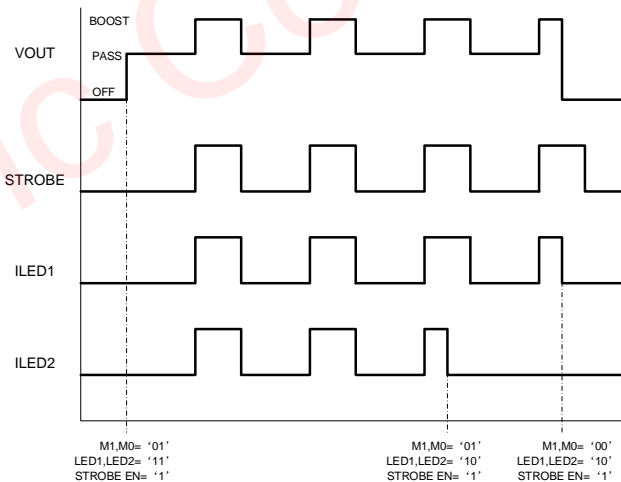

**IR Mode with Boost**

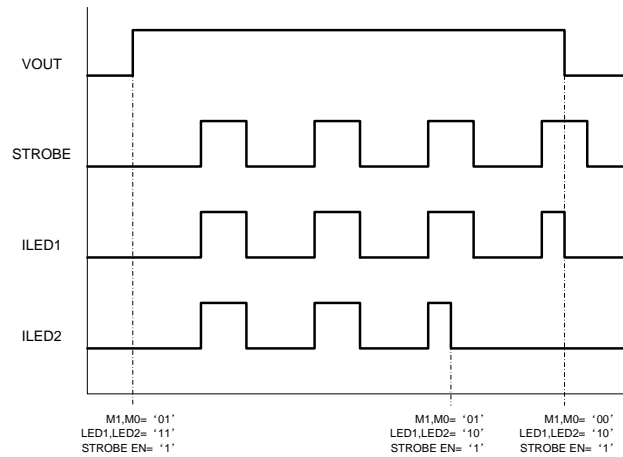

IR Mode Pass Only

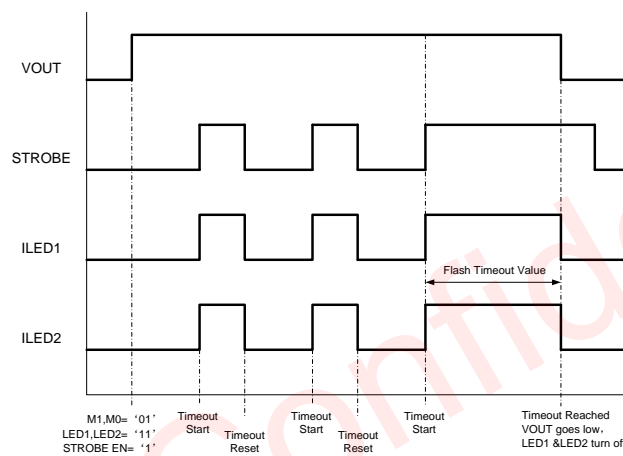

IR Mode Timeout

### Soft Start-up

Turn on the AW36515 Torch and Flash modes can be done through the Enable Register. On start-up, when  $V_{OUT}$  is less than  $V_{IN}$  the internal synchronous PMOS turns on as a current source and delivers 200mA (typical) to the output capacitor. During this time the current source (LED) is off. When the voltage across the output capacitor reaches 2.2 V (typical) the current source turns on. At turn-on the current source steps through each FLASH or TORCH level until the target LED current is reached. This gives the device a controlled turn-on and limits inrush current from the  $V_{IN}$  supply.

### Pass Mode

The AW36515 starts up in Pass Mode and stays there until Boost Mode is needed to maintain regulation. In Pass Mode the boost converter does not switch, and the synchronous PMOS turns fully on bringing  $V_{OUT}$  up to  $V_{IN} - I_{LED} \times R_{PMOS}$ . In Pass Mode the inductor current is not limited by the peak current limit. If the voltage difference between  $V_{OUT}$  and  $V_{LED}$  falls below  $V_{HR}$ , the device switches to Boost Mode.

AW36515 can be forced into pass mode only state regardless the  $V_{HR}$ , which must be set before system enter Boost mode, once system enter Boost mode, the bit2 of Boost Configuration Register (0x07) is invalid unless setting the device enter standby mode, or by setting the SW RESET bit to a '1', or by removing power to the AW36515.

### Power Amplifier Synchronization (TX)

The TX pin is a Power Amplifier Synchronization input. This is designed to reduce the flash LED current and thus limit the battery current during high battery current conditions such as PA transmit events. When the AW36515 is engaged in a Flash event, and the TX pin is pulled high, the LED current is forced into Torch Mode at the programmed Torch current setting. If the TX pin is then pulled low before the Flash pulse terminates, the LED current returns to the previous Flash current level. At the end of the Flash time-out, whether the TX pin is high or low, the LED current turns off.

The TX input can be disabled by setting bit[7] (TX Enable) to a '0' in the Enable Register(0x01).

### Input Voltage Flash Monitor (IVFM)

The AW36515 has the ability to adjust the flash current based upon the voltage level present at the IN pin utilizing the Input Voltage Flash Monitor (IVFM). The adjustable threshold ranges from 2.9 V to 3.6 V in 100mV steps as well as adjustable hysteresis, with Stop-and-Hold mode. The IVFM threshold and hysteresis are controlled by bits[5:3] and bit[2] respectively, in the IVFM Register(0x02). The Flags2 Register has the IVFM flag bit set when the input voltage crosses the IVFM threshold value. Additionally, the IVFM threshold sets the input voltage boundary that forces the AW36515 to either stop ramping the flash current during startup in Stop and Hold Mode.

- Stop and Hold Mode: Stops Current Ramp and holds the level for the remaining flash, If  $V_{IN}$  falls below the IVFM threshold value.

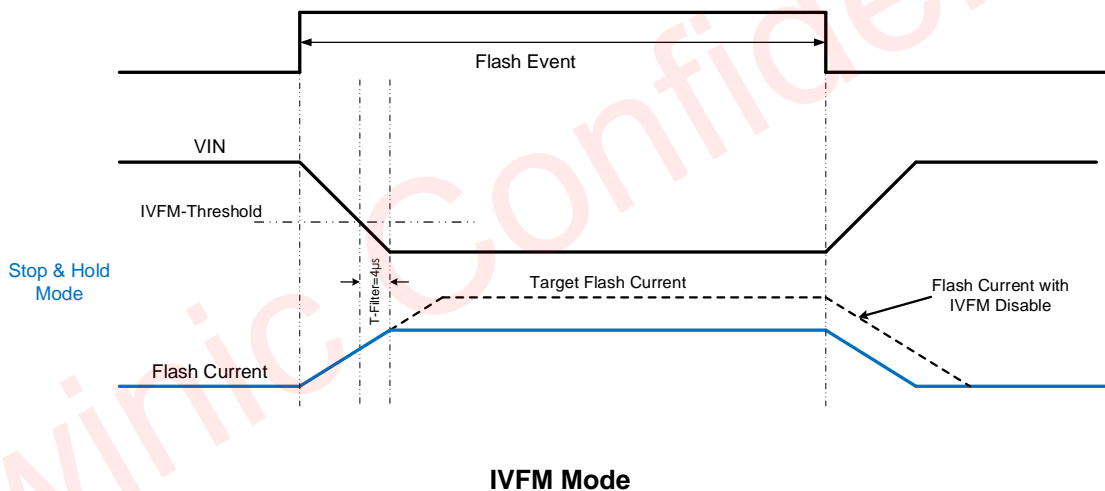

### Flash Timeout

The Flash Timeout period sets the maximum time of one flash event, whether a flash stop command is received or not. The AW36515 has 16 timeout levels ranging from 40ms to 1.6s (see [TIMING CONFIGURATION REGISTER \(0X08\)](#) for more detail). Flash Timeout applies to both Flash and IR modes, and it continues to count when the Flash mode is forced into Torch mode during a TX high event. The mode bits are cleared and bit[0] is set in the Flags1 register(0x0A) upon a Flash Timeout. This fault flag can be reset to '0' by reading back the Flags1 Register (0x0A), 'or by setting the SW RESET bit to a '1', or by removing power to the AW36515.

### Current Limit

When the inductor current limit is reached, the AW36515 terminates the charging phase of the switching cycle until the next switching period. If the over-current condition persists, the device operates continuously in current limit. The AW36515 features two selectable inductor current limits(1.9A and 2.8A) that are programmable by bit[0] in Boost configuration Register(0x07).

Since the current limit is sensed in the NMOS switch, there is no mechanism to limit the current when the device operates in Pass Mode (current does not flow through the NMOS in pass mode). The mode bits are not cleared upon a Current Limit event, but a flag bit[3] is set in the Flags1 register(0x0A).

This fault flag can be reset to '0' by reading back the Flags1 Register (0x0A), or by setting the SW RESET bit to a '1', or by removing power to the AW36515.

### **Undervoltage Lockout (UVLO)**

The AW36515 has an internal comparator that monitors the voltage at IN and forces the AW36515 into standby if the input voltage drops to 2.5 V. If the UVLO monitor threshold is tripped, the UVLO flag bit is set in the Flags1 Register (0x0A). If the input voltage rises above 2.5 V, the AW36515 is not available for operation until there is an I<sup>2</sup>C read of the Flags1 Register (0x0A). Upon a read, the Flags1 register is cleared, and normal operation can resume if the input voltage is greater than 2.5 V.

### **VOUT Short Fault**

The Output Short Fault flag reads back a '1' if the device is active in Flash or Torch mode and the boost output experiences a short condition. VOUT short condition occurs if the voltage at OUT goes below 2.3V (typ.) while the device is in Torch or Flash mode. There is a deglitch time of 2.048ms before the VOUT Short flag is valid. The mode bits are cleared upon an the VOUT short fault. The AW36515 is not available for operation until VOUT Fault flags is cleared. The VOUT Short Fault can be reset to '0' by reading back the Flags1 Register (0x0A), or by setting the SW RESET bit to a '1', or by removing power to the AW36515.

### **LED Short Fault**

The LED Short Fault flags read back a '1' if the device is active in Flash or Torch mode and either active LED output experiences a short condition. An LED short condition is determined if the voltage at LED1 or LED2 goes below 500mV (typ.) while the device is in Torch or Flash mode. There is a deglitch time of 256μs before the LED Short Fault flag is valid. The mode bits are cleared upon an LED Short Fault. The AW36515 is not available for operation until the LED Short Fault flags is cleared. The LED Short Faults can be reset to '0' by reading back the Flags1 Register (0x0A), or by setting the SW RESET bit to a '1', or by removing power to the AW36515.

### **Overvoltage Protection (OVP)**

The output voltage is limited to typically 5 V. In situations such as an open LED, the AW36515 raises the output voltage in order to try and keep the LED current at its target value. When VOUT reaches 5 V (typ.) the overvoltage comparator trips and turns off the internal NMOS. When VOUT falls below the “V<sub>OVP</sub> Off Threshold”, the AW36515 begins switching again. The mode bits are cleared, and the OVP Fault flag is set, when an OVP condition is present for three rising OVP edges. This prevents momentary OVP events from forcing the device to shut down. The AW36515 is not available for operation until the OVP Fault flag is cleared. The OVP Fault can be reset to '0' by reading back the Flags2 Register (0x0A), or by setting the SW RESET bit to a '1', or by removing power to the AW36515.

### **Thermal Shutdown (TSD)**

When the AW36515 die temperature reaches 155°C, the thermal shutdown detection circuit trips, forcing the AW36515 enter standby mode and writing a '1' to the Thermal Shutdown Fault flag of the Flags1 Register (0x0A) . The AW36515 is only allowed to restart after the Thermal Shutdown Fault flag is cleared. The Thermal Shutdown Faults can be reset to '0' by reading back the Flags1 Register (0x0A), or by setting the SW RESET bit to a '1', or by removing power to the AW36515. Upon restart, if the die temperature is still above 155°C, the AW36515 resets the Fault flag and re-enters standby mode.

## Programming

### Control Truth Table

MODE1	MODE0	STROBE EN	TORCH EN	STROBE/TORCH PIN	ACTION
0	0	0	0	X	Standby
0	0	0	1	Pos edge	Ext Torch
0	0	1	0	Pos edge	Ext Flash
0	0	1	1	Pos edge	Ext Flash
1	0	X	X	X	Int Torch
1	1	X	X	X	Int Flash
0	1	0	X	X	IRLED Standby
0	1	1	X	0	IRLED Standby
0	1	1	X	Pos edge	IRLED Enabled

### I<sup>2</sup>C Interface

#### Data Validation

When SCL is high level, SDA level must be constant. SDA can be changed only when SCL is low level.

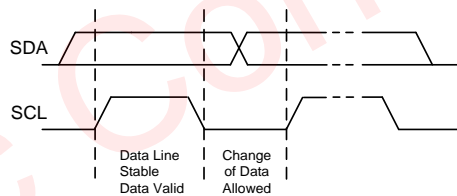

Data Validation Diagram

#### I<sup>2</sup>C Start/Stop

I<sup>2</sup>C start: SDA changes from high level to low level when SCL is high level.

I<sup>2</sup>C stop: SDA changes from low level to high level when SCL is high level.

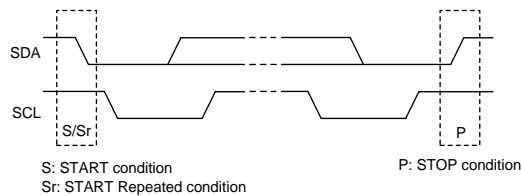

Start and Stop Conditions

### ACK (Acknowledgement)

ACK means the successful transfer of I<sup>2</sup>C bus data. After master sends an 8-bit data, SDA must be released; SDA is pulled to GND by slave device when slave acknowledges.

When master reads, slave device sends 8-bit data, releases the SDA and waits for ACK from master. If ACK is sent and I<sup>2</sup>C stop is not sent by master, slave device sends the next data. If ACK is not sent by master, slave device stops to send data and waits for I<sup>2</sup>C stop.

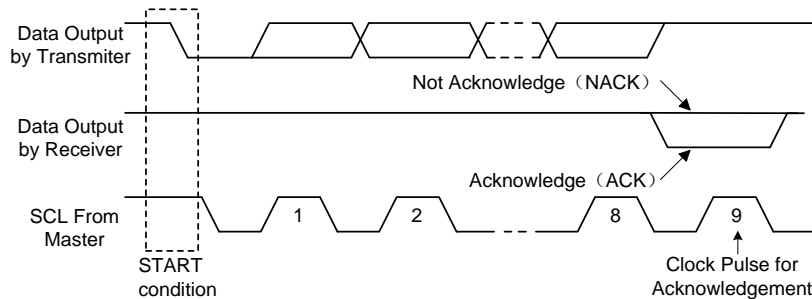

I<sup>2</sup>C ACK Timing

### Write Cycle

One data bit is transferred during each clock pulse. Data is sampled during the high state of the serial clock (SCL). Consequently, throughout the clock's high period, the data should remain stable. Any changes on the SDA line during the high state of the SCL and in the middle of a transaction, aborts the current transaction. New data should be sent during the low SCL state. This protocol allows a single data line to transfer both command/control information and data using the synchronous serial clock.

Each data transaction is composed of a Start Condition, a number of byte transfers (set by the software) and a Stop Condition to terminate the transaction. Every byte written to the SDA bus must be 8 bits long and is transferred with the most significant bit first. After each byte, an Acknowledge signal must follow.

In a write process, the following steps should be followed:

- Master device generates START condition. The "START" signal is generated by lowering the SDA signal while the SCL signal is high.
- Master device sends slave address (7-bit) and the data direction bit (R/W = 0).
- Slave device sends acknowledge signal if the slave address is correct.
- Master sends control register address (8-bit)
- Slave sends acknowledge signal
- Master sends data byte to be written to the addressed register
- Slave sends acknowledge signal
- If master will send further data bytes the control register address will be incremented by one after acknowledge signal (repeat step f and g)
- Master generates STOP condition to indicate write cycle end



I<sup>2</sup>C Write Timing

### Read Cycle

In a read cycle, the following steps should be followed:

- a) Master device generates START condition.
- b) Master device sends slave address (7-bit) and the data direction bit (R/W = 0).
- c) Slave device sends acknowledge signal if the slave address is correct.
- d) Master sends control register address (8-bit).
- e) Slave sends acknowledge signal.
- f) Master generates STOP condition followed with START condition or REPEAT START condition.
- g) Master device sends slave address (7-bit) and the data direction bit (R/W = 1).
- h) Slave device sends acknowledge signal if the slave address is correct.
- i) Slave sends data byte from addressed register.
- j) If the master device sends acknowledge signal, the slave device will increase the control register address by one, then send the next data from the new addressed register.
- k) If the master device generates STOP condition, the read cycle is ended.

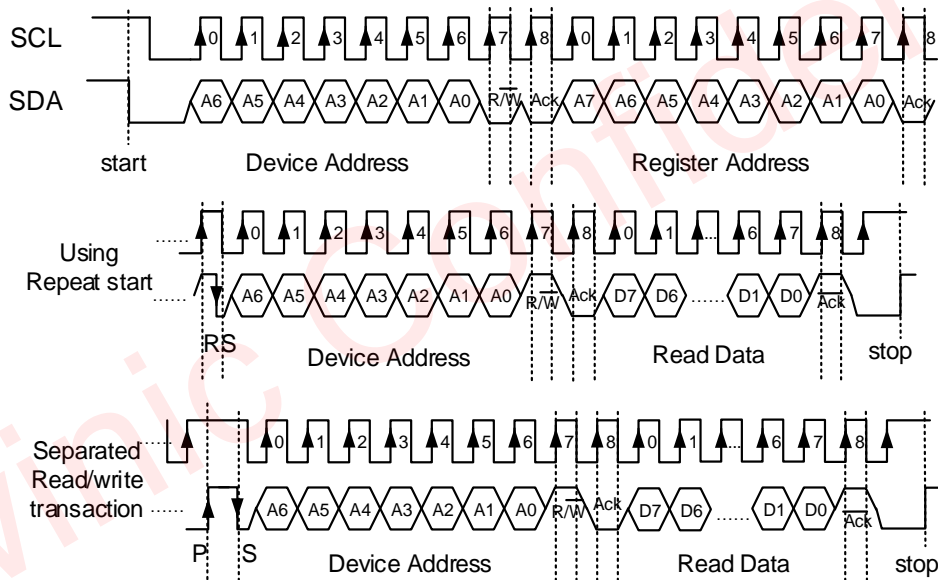

I<sup>2</sup>C Read Timing



## Register Configuration

### Register List

Register name	Address(HEX)	Read/Write	Default Value
Chip ID Register	0x00	Read	0x30
Enable Register	0x01	Read/Write	0x80
IVFM Register	0x02	Read/Write	0x01
LED1 Flash Brightness Register	0x03	Read/Write	0x7F
LED2 Flash Brightness Register	0x04	Read/Write	0x7F
LED1 Torch Brightness Register	0x05	Read/Write	0x7F
LED2 Torch Brightness Register	0x06	Read/Write	0x7F
Boost Configuration Register	0x07	Read/Write	0x09
Timing Configuration Register	0x08	Read/Write	0x1A
Flags1 Register	0x0A	Read	0x00
Flags2 Register	0x0B	Read	0x00
Device ID Register	0x0C	Read	0x02
Last Flash Register	0x0D	Read	0x00

### Register Detailed Description

#### ✧ Chip ID Register (0x00)

Bit 7	Bit 6	Bit 5	Bit 4	Bit 3	Bit 2	Bit 1	Bit 0
Chip ID: "00110000"							

#### ✧ Enable Register (0x01)

Bit 7	Bit 6	Bit 5	Bit 4	Bit 3	Bit 2	Bit 1	Bit 0
<b>TX Pin Enable</b> 0=Disabled 1=Enabled (Default)	<b>Strobe Type</b> 0=Level Triggered (Default) 1=Edge Triggered	<b>Strobe Enable</b> 0=Disabled (Default) 1=Enabled	<b>Torch Enable</b> 0=Disabled (Default) 1=Enabled	<b>Mode Bits: M1, M0</b> 00=Standby (Default) 01=IR Drive 10=Torch 11=Flash	<b>LED2 Enable</b> 0=OFF (Default) 1=ON	<b>LED1 Enable</b> 0=OFF (Default) 1=ON	

#### Note:

In Edge or Level Strobe Mode, it is recommended that the trigger pulse width be set greater than 1ms to ensure proper turn-on of the device.

◇ **IVFM Register (0x02)**

Bit 7	Bit 6	Bit 5	Bit 4	Bit 3	Bit 2	Bit 1	Bit 0
RFU	UVLO Circuitry 0=Disabled (Default) 1=Enabled	IVFM Levels 000=2.9 V (Default) 001=3.0 V 010=3.1 V 011=3.2 V 100=3.3 V 101=3.4 V 110=3.5 V 111=3.6 V			RFU	RFU	IVFM Enable 0=Disabled (Default) 1=Enabled

◇ **LED1 Flash Brightness Register (0x03)**

Bit 7	Bit 6	Bit 5	Bit 4	Bit 3	Bit 2	Bit 1	Bit 0
<b>LED1 Flash Brightness Levels</b> $I_{FLASH}(mA) \approx (Brightness\ Code * 7.83mA) + 3.91mA$  00000000=3.91 mA ..... 01111111=998.32 mA (Default) ..... 11111111=2.0 A							

◇ **LED2 Flash Brightness Register (0x04)**

Bit 7	Bit 6	Bit 5	Bit 4	Bit 3	Bit 2	Bit 1	Bit 0
<b>LED2 Flash Brightness Levels</b> $I_{FLASH}(mA) \approx (Brightness\ Code * 7.83mA) + 3.91mA$  00000000=3.91 mA ..... 01111111=998.32 mA (Default) ..... 11111111=2.0 A							

◇ **LED1 Torch Brightness Register (0x05)**

Bit 7	Bit 6	Bit 5	Bit 4	Bit 3	Bit 2	Bit 1	Bit 0
<b>LED1 Torch Brightness Levels</b> $I_{TORCH}(mA) \approx (Brightness\ Code * 1.96mA) + 0.98mA$  00000000=0.98 mA ..... 01111111=249.9 mA (Default) ..... 11111111=500 mA							

◇ **LED2 Torch Brightness Register (0x06)**

Bit 7	Bit 6	Bit 5	Bit 4	Bit 3	Bit 2	Bit 1	Bit 0
<b>LED2 Torch Brightness Levels</b> $I_{TORCH}(mA) \approx (Brightness\ Code * 1.96mA) + 0.98mA$  00000000=0.98 mA ..... 01111111=249.9 mA (Default) ..... 11111111=500 mA							

◇ **Boost Configuration Register (0x07)**

Bit 7	Bit 6	Bit 5	Bit 4	Bit 3	Bit 2	Bit 1	Bit 0
<b>Software Reset Bit</b> 0=Not Reset (Default) 1=Reset	RFU	RFU	RFU	<b>LED Pin Short Fault Detect</b> 0=Disabled (Default) 1=Enabled (Default)	<b>Boost Mode</b> 0=Normal (Default) 1=Pass Mode Only	<b>Boost Frequency Select</b> 0=2 MHz (Default) 1=4 MHz	<b>Boost Current Limit</b> 0=1.9A 1=2.8A (Default)

◇ **Timing Configuration Register (0x08)**

Bit 7	Bit 6	Bit 5	Bit 4	Bit 3	Bit 2	Bit 1	Bit 0
RFU	<b>Torch Current Ramp time</b> 000=No Ramp 001=1 ms (Default) 010=32 ms 011=64 ms 100=128 ms 101=256 ms 110=512 ms 111=1024 ms			<b>Flash Time-out Duration</b> 0000=40 ms 0001=80 ms 0010=120 ms 0011=160 ms 0100=200 ms 0101=240 ms 0110=280 ms 0111=320 ms 1000=360 ms 1001=400 ms 1010=600 ms (Default) 1011=800 ms 1100=1000 ms 1101=1200 ms 1110=1400 ms 1111=1600 ms			

◇ **Flags1 Register (0x0A)**

Bit 7	Bit 6	Bit 5	Bit 4	Bit 3	Bit 2	Bit 1	Bit 0
<b>TX Flag</b>	<b>V<sub>OUT</sub> Short Fault</b>	<b>LED1 Short Fault</b>	<b>LED2 Short Fault</b>	<b>Current Limit Flag</b>	<b>Thermal Shutdown (TSD) Fault</b>	<b>UVLO Fault</b>	<b>Flash Time-Out Flag</b>

◇ **Flags2 Register (0x0B)**

Bit 7	Bit 6	Bit 5	Bit 4	Bit 3	Bit 2	Bit 1	Bit 0
RFU	RFU	RFU	RFU	RFU	<b>IVFM Trip Flag</b>	<b>OVP Fault</b>	RFU

◇ **Device ID Register (0x0C)**

Bit 7	Bit 6	Bit 5	Bit 4	Bit 3	Bit 2	Bit 1	Bit 0
RFU	RFU	RFU	<b>Device ID</b> "00"	<b>Silicon Revision Bits</b> "010"			

◇ **Last Flash Register (0x0D)**

Bit 7	Bit 6	Bit 5	Bit 4	Bit 3	Bit 2	Bit 1	Bit 0
RFU	The value stored is always the last current value the IVFM detection block set ILED=IFLASH-TARGET*((code+1)/256)						

## Application Information

The AW36515 can drive two flash LEDs at currents up to 2 A per LED. The 2MHz/4MHz DC-DC boost regulator allows for the use of small value discrete external components. Below are some peripheral selection guidelines.

### Output Capacitor Selection

The AW36515 is designed to operate with a 10μF ceramic output capacitor. When the boost converter is running, the output capacitor supplies the load current during the boost converter on-time. When the NMOS switch turns off, the inductor energy is discharged through the internal PMOS switch, supplying power to the load and restoring charge to the output capacitor. This causes a sag in the output voltage during the on-time and a rise in the output voltage during the off-time. The output capacitor is therefore chosen to limit the output ripple to an acceptable level depending on load current and input/output voltage differentials and also to ensure the converter remains stable.

Larger capacitors such as a 22μF or capacitors in parallel can be used if lower output voltage ripple is desired. To estimate the output voltage ripple considering the ripple due to capacitor discharge ( $\Delta V_Q$ ) and the ripple due to the capacitors ESR ( $\Delta V_{ESR}$ ) use the following equations:

For continuous conduction mode, the output voltage ripple due to the capacitor discharge is:

$$\Delta V_Q = \frac{(V_{OUT} - V_{IN}) \times I_{LED}}{V_{OUT} \times f \times C_{OUT}}$$

The output voltage ripple due to the output capacitors ESR is found by:

$$\Delta V_{ESR} = R_{ESR} \times \left( \frac{V_{OUT} \times I_{LED}}{V_{IN}} + \frac{\Delta I_L}{2} \right) \quad \text{Where} \quad \Delta I_L = \frac{V_{IN} \times (V_{OUT} - V_{IN})}{V_{OUT} \times f \times L}$$

In ceramic capacitors the ESR is very low so the assumption is that 80% of the output voltage ripple is due to capacitor discharge and 20% from ESR. Table 1 lists different manufacturers for various output capacitors and their case sizes suitable for use with the AW36515.

### Input Capacitor Selection

Choosing the correct size and type of input capacitor helps minimize the voltage ripple caused by the switching of the AW36515 boost converter and reduce noise on the boost converter's input pin that can feed through and disrupt internal analog signals. In the typical application circuit a 10-μF ceramic input capacitor works well. It is important to place the input capacitor as close as possible to the AW36515 input (IN) pin. This reduces the series resistance and inductance that can inject noise into the device due to the input switching currents. Table 1 lists various input capacitors recommended for use with the AW36515.

**Table 1 Recommended Input/ Output Capacitors (X5R/X7R Dielectric)**

MANUFACTURER	PART NUMBER	VALUE	CASE	VOLTAGE RATING
TDK	C1608JB0J106M	10μF	0603	6.3V
TDK	C2012JB1A106M	10μF	0805	10V
Murata	GRM188R60J106M	10μF	0603	6.3V
Murata	GRM21BR61A106KE19	10μF	0805	10V

## Inductor Selection

The AW36515 is designed to use a 0.47μH or 1μH inductor. When the device is boosting ( $V_{OUT} > V_{IN}$ ) the inductor is typically the largest area of efficiency loss in the circuit. Therefore, choosing an inductor with the lowest possible series resistance is important. Additionally, the saturation rating of the inductor should be greater than the maximum operating peak current of the AW36515. This prevents excess efficiency loss that can occur with inductors that operate in saturation. For proper inductor operation and circuit performance, ensure that the inductor saturation and the peak current limit setting of the AW36515 are greater than  $I_{PEAK}$  in the following calculation:

$$I_{PEAK} = \frac{I_{LED} \times V_{OUT}}{\eta \times V_{IN}} + \Delta I_L \quad \text{where} \quad \Delta I_L = \frac{V_{IN} \times (V_{OUT} - V_{IN})}{2 \times f_{SW} \times L \times V_{OUT}}$$

And  $f_{SW} = 2$  or 4MHz.

Table 2 lists various inductors and their manufacturers that work well with the AW36515.

**Table 2 Recommended Inductors**

MANUFACTURER	L	PART NO.	SIZE	ISAT	R <sub>DC</sub>
TOKO	1μH	DFE201610P-1R0M	2.0 mm x 1.6 mm x 1.0 mm	3.7A	58mΩ
TOKO	0.47μH	DFE201610P-R470M	2.0 mm x 1.6 mm x 1.0 mm	4.1A	32mΩ
Sunlord	1μH	WPN252012H1R0MT	2.5mm x 2.0mm x 1.2mm	3.4A	48mΩ

## PCB Layout Consideration

### Layout Guidelines

The high switching frequency and large switching currents of the AW36515 make the choice of layout important. The following steps should be used as a reference to ensure the device is stable and maintains proper LED current regulation across its intended operating voltage and current range.

1. Place  $C_{IN}$  on the top layer (same layer as the AW36515) and as close to the device as possible. The input capacitor conducts the driver currents during the low-side MOSFET turn-on and turn-off and can detect current spikes over 2 A in amplitude. Connecting the input capacitor through short, wide traces to both the IN and GND pins reduces the inductive voltage spikes that occur during switching which can corrupt the  $V_{IN}$  line.
2. Place  $C_{OUT}$  on the top layer (same layer as the AW36515) and as close as possible to the OUT and GND pin. The returns for both  $C_{IN}$  and  $C_{OUT}$  should come together at one point, as close to the GND pin as possible. Connecting  $C_{OUT}$  through short, wide traces reduce the series inductance on the OUT and GND pins that can corrupt the  $V_{OUT}$  and GND lines and cause excessive noise in the device and surrounding circuitry.
3. Connect the inductor on the top layer close to the SW pin. There should be a low-impedance connection from the inductor to SW due to the large DC inductor current, and at the same time the area occupied by the SW node should be small so as to reduce the capacitive coupling of the high  $dV/dT$  present at SW that can couple into nearby traces.
4. Avoid routing logic traces near the SW node so as to avoid any capacitive coupling from SW onto any high-impedance logic lines such as TX, STROBE/TORCH, SDA, and SCL. A good approach is to insert an inner layer GND plane underneath the SW node and between any nearby routed traces. This creates a shield from the electric field generated at SW.
5. Terminate the Flash LED cathodes directly to the GND pin of the AW36515. If possible, route the LED returns with a dedicated path so as to keep the high amplitude LED currents out of the GND plane. For Flash LEDs that are routed relatively far away from the AW36515, a good approach is to sandwich the forward and return current paths over the top of each other on two layers. This helps reduce the inductance of the LED current paths.

## Package Description

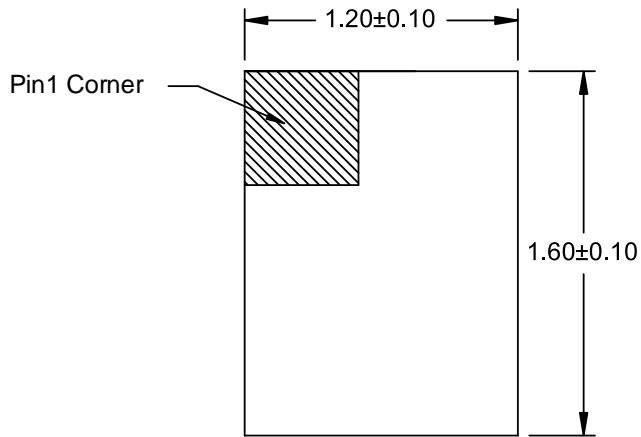

TOP VIEW

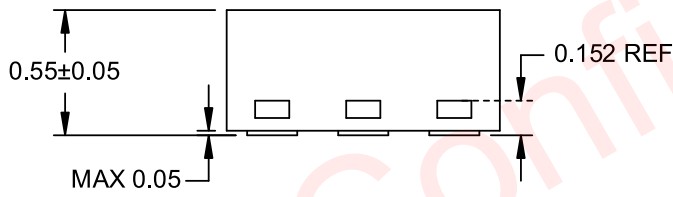

SIDE VIEW

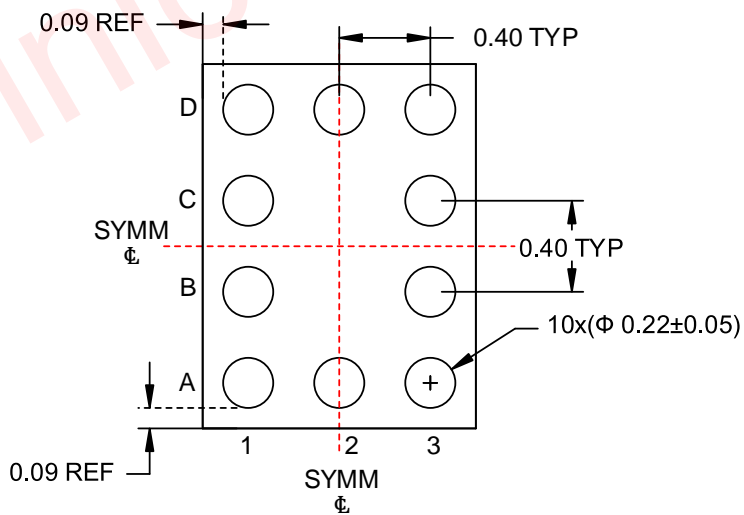

BOTTOM VIEW

Unit: mm

## Land Pattern Data

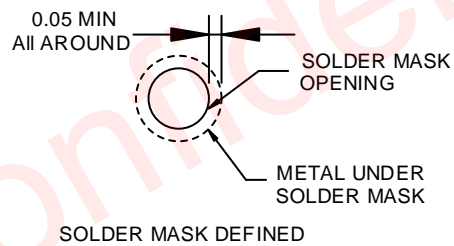
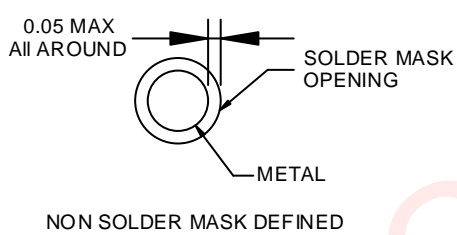
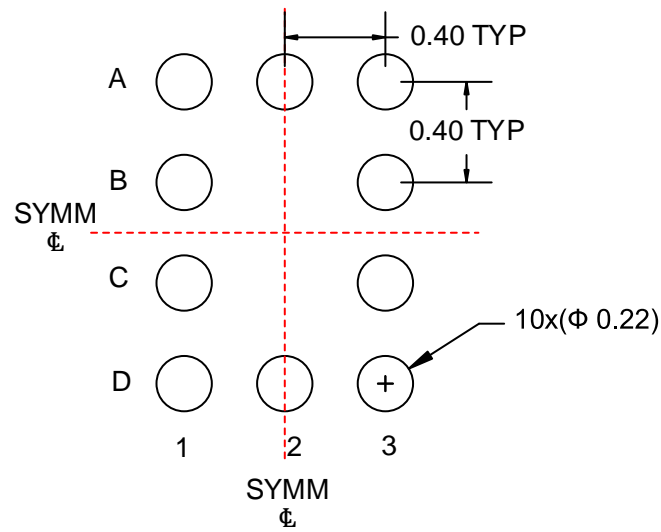

Unit: mm



## Tape and Reel Information

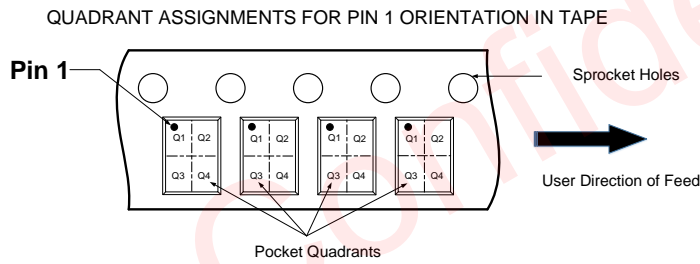
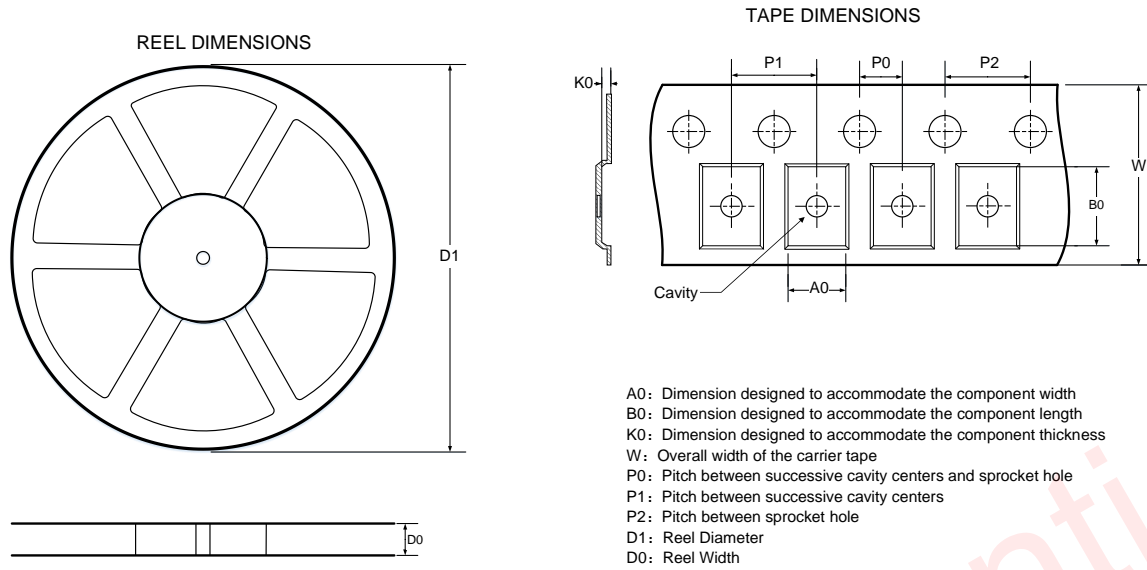

**DIMENSIONS AND PIN1 ORIENTATION**

D1 (mm)	D0 (mm)	A0 (mm)	B0 (mm)	K0 (mm)	P0 (mm)	P1 (mm)	P2 (mm)	W (mm)	Pin1 Quadrant
180	9.5	1.4	1.85	0.75	2	4	4	8	Q1

All dimensions are nominal

## Revision History

Version	Date	Change Record
V1.0	Oct. 2018	Product Datasheet V1.0 Released
V1.1	Oct. 2019	I <sup>2</sup> C address is modified

Awinic Confidential

## DISCLAIMER

Information in this document is believed to be accurate and reliable. However, Shanghai AWINIC Technology Co., Ltd (AWINIC Technology) does not give any representations or warranties, expressed or implied, as to the accuracy or completeness of such information and shall have no liability for the consequences of use of such information.

AWINIC Technology reserves the right to make changes to information published in this document, including without limitation specifications and product descriptions, at any time and without notice. Customers shall obtain the latest relevant information before placing orders and shall verify that such information is current and complete. This document supersedes and replaces all information supplied prior to the publication hereof.

AWINIC Technology products are not designed, authorized or warranted to be suitable for use in medical, military, aircraft, space or life support equipment, nor in applications where failure or malfunction of an AWINIC Technology product can reasonably be expected to result in personal injury, death or severe property or environmental damage. AWINIC Technology accepts no liability for inclusion and/or use of AWINIC Technology products in such equipment or applications and therefore such inclusion and/or use is at the customer's own risk.

Applications that are described herein for any of these products are for illustrative purposes only. AWINIC Technology makes no representation or warranty that such applications will be suitable for the specified use without further testing or modification.

All products are sold subject to the general terms and conditions of commercial sale supplied at the time of order acknowledgement.

Nothing in this document may be interpreted or construed as an offer to sell products that is open for acceptance or the grant, conveyance or implication of any license under any copyrights, patents or other industrial or intellectual property rights.

Reproduction of AWINIC information in AWINIC data books or data sheets is permissible only if reproduction is without alteration and is accompanied by all associated warranties, conditions, limitations, and notices. AWINIC is not responsible or liable for such altered documentation. Information of third parties may be subject to additional restrictions.

Resale of AWINIC components or services with statements different from or beyond the parameters stated by AWINIC for that component or service voids all express and any implied warranties for the associated AWINIC component or service and is an unfair and deceptive business practice. AWINIC is not responsible or liable for any such statements.