

GENERAL DESCRIPTION

The SGM7SZ04 is a single inverter with the advanced CMOS technology. The supply voltage pin of this device accepts any voltage from 1.65V to 5.5V. The input can tolerate the maximum of 6V, regardless of the supply voltage range. When V_{CC} is 0V, the input and output are in the high-impedance state.

This device can achieve ultra-high speed operation with high output drive, meanwhile, the low static power dissipation is maintained over the wide supply voltage operating range.

The SGM7SZ04 is available in Green UTDFN-1.45×1-6L, SC70-5 and SOT-23-5 packages. It operates over an ambient temperature range of -40°C to +125°C.

LOGIC SYMBOL

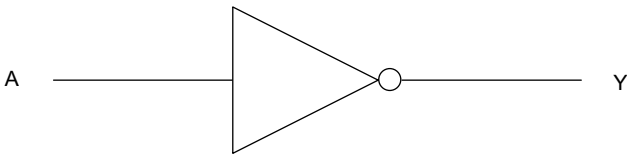

FEATURES

- **Wide Supply Voltage Range: 1.65V to 5.5V**
- **Inputs Over-Voltage Tolerance Makes 5V to 3V Translation Available**
- **+24mA/-24mA Output Current at $V_{CC} = 3V$**
- **Ultra-High Speed: t_{PD} of 4.2ns (TYP) into 50pF at $V_{CC} = 3.3V$**
- **Support LCX Performance at $V_{CC} = 3.3V$**
- **Power Down High-Impedance Input/Output**
- **-40°C to +125°C Operating Temperature Range**
- **Available in Green UTDFN-1.45×1-6L, SC70-5 and SOT-23-5 Packages**

FUNCTION TABLE

INPUT	OUTPUT
A	Y
L	H
H	L

$Y = \bar{A}$

H = High Voltage Level

L = Low Voltage Level

PACKAGE/ORDERING INFORMATION

MODEL	PACKAGE DESCRIPTION	SPECIFIED TEMPERATURE RANGE	ORDERING NUMBER	PACKAGE MARKING	PACKING OPTION
SGM7SZ04	SC70-5	-40°C to +125°C	SGM7SZ04XC5G/TR	SF3XX	Tape and Reel, 3000
	SOT-23-5	-40°C to +125°C	SGM7SZ04XN5G/TR	SF4XX	Tape and Reel, 3000
	UTDFN-1.45×1-6L	-40°C to +125°C	SGM7SZ04XUDL6G/TR	TCX	Tape and Reel, 5000

MARKING INFORMATION

NOTE: X = Date Code. XX = Date Code.

SC70-5/SOT-23-5

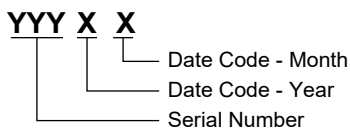

UTDFN-1.45×1-6L

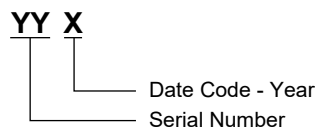

Green (RoHS & HSF): SG Micro Corp defines "Green" to mean Pb-Free (RoHS compatible) and free of halogen substances. If you have additional comments or questions, please contact your SGMICRO representative directly.

ABSOLUTE MAXIMUM RATINGS

- Supply Voltage Range, V_{CC} -0.5V to 6V
- DC Input Voltage Range, V_{IN} -0.5V to 6V
- DC Output Voltage Range, V_{OUT} -0.5V to 6V
- DC Input Diode Current, I_{IK} ($V_{IN} < -0.5V$) -50mA
- DC Output Diode Current, I_{OK} ($V_{OUT} < -0.5V$)..... -50mA
- DC Output Current, I_{OUT} $\pm 50mA$
- DC V_{CC} or Ground Current, I_{CC} or I_{GND} $\pm 50mA$
- Package Thermal Resistance
- SC70-5, θ_{JA} 373°C/W
- SOT-23-5, θ_{JA} 376°C/W
- UTDFN-1.45×1-6L, θ_{JA} 332°C/W
- Junction Temperature..... +150°C
- Storage Temperature Range -65°C to +150°C
- Lead Temperature (Soldering, 10s)..... +260°C
- ESD Susceptibility
- HBM..... 8000V
- MM..... 400V

RECOMMENDED OPERATING CONDITIONS

- Operating Temperature Range -40°C to +125°C

OVERSTRESS CAUTION

Stresses beyond those listed in Absolute Maximum Ratings may cause permanent damage to the device. Exposure to absolute maximum rating conditions for extended periods may affect reliability. Functional operation of the device at any conditions beyond those indicated in the Recommended Operating Conditions section is not implied.

ESD SENSITIVITY CAUTION

This integrated circuit can be damaged if ESD protections are not considered carefully. SGMICRO recommends that all integrated circuits be handled with appropriate precautions. Failure to observe proper handling and installation procedures can cause damage. ESD damage can range from subtle performance degradation to complete device failure. Precision integrated circuits may be more susceptible to damage because even small parametric changes could cause the device not to meet the published specifications.

DISCLAIMER

SG Micro Corp reserves the right to make any change in circuit design, or specifications without prior notice.

PIN CONFIGURATIONS

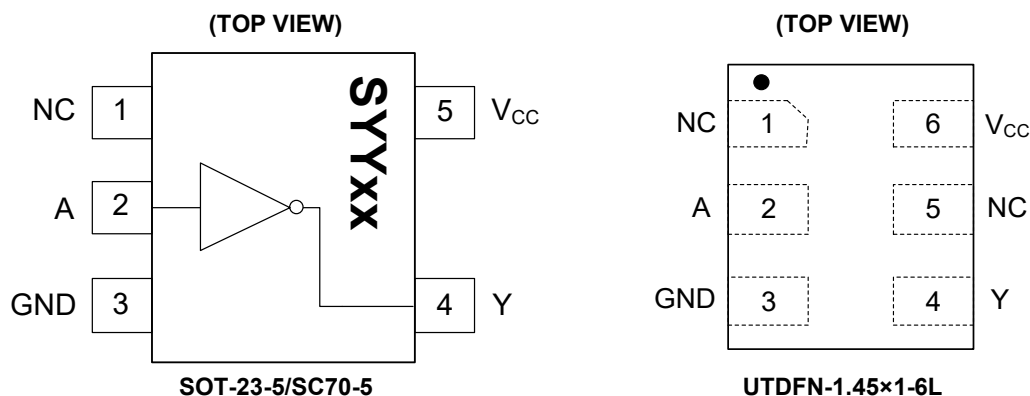

PIN DESCRIPTION

PIN		NAME	FUNCTION
SOT-23-5/SC70-5	UTDFN-1.45x1-6L		
1	1, 5	NC	No Connection.
2	2	A	Data Input. Unused input must be held high or low. It may not float.
3	3	GND	Ground.
4	4	Y	Data Output.
5	6	V _{CC}	Power Supply.

ELECTRICAL CHARACTERISTICS(Full = -40°C to +125°C, typical values are at T_A = +25°C, unless otherwise noted.)

PARAMETER	SYMBOL	CONDITIONS		V _{CC} (V)	MIN	TYP	MAX	UNITS
General								
Power Supply Range	V _{CC}				1.65		5.50	V
Supply Voltage Data Retention					1.50		5.50	
Input Voltage	V _{IN}				0.00		5.50	V
Output Voltage	V _{OUT}				0.00		V _{CC}	V
Input Rise and Fall Times	t _R , t _F			1.8, 2.5 ± 0.2	0		20	ns/V
				3.3 ± 0.3	0		10	
				5.0 ± 0.5	0		5	
DC Performance								
High-Level Input Voltage	V _{IH}			1.65 to 5.5	0.75 × V _{CC}			V
Low-Level Input Voltage	V _{IL}			1.65 to 5.5			0.20 × V _{CC}	V
High-Level Output Voltage	V _{OH}	V _{IN} = V _{IL}	I _{OH} = -100μA	1.65	1.62	1.65		V
				1.80	1.77	1.80		
				2.30	2.27	2.30		
				3.00	2.97	3.00		
				4.50	4.47	4.50		
			I _{OH} = -4mA	1.65	1.46	1.55		
			I _{OH} = -8mA	2.30	2.01	2.18		
			I _{OH} = -16mA	3.00	2.49	2.81		
			I _{OH} = -24mA	3.00	2.30	2.70		
Low-Level Output Voltage	V _{OL}	V _{IN} = V _{IH}	I _{OL} = 100μA	1.65		0.00	0.02	V
				1.80		0.00	0.02	
				2.30		0.00	0.02	
				3.00		0.00	0.02	
				4.50		0.00	0.02	
			I _{OL} = 4mA	1.65		0.06	0.12	
			I _{OL} = 8mA	2.30		0.09	0.18	
			I _{OL} = 16mA	3.00		0.16	0.33	
			I _{OL} = 24mA	3.00		0.24	0.51	
I _{OL} = 32mA	4.50		0.29	0.58				
Input Leakage Current	I _{IN}	V _{IN} = 5.5V, GND		0 to 5.5		±0.10	±5	μA
Power-Off Leakage Current	I _{OFF}	V _{IN} or V _{OUT} = 5.5V		0		0.10	5	μA
Quiescent Supply Current	I _{CC}	V _{IN} = 5.5V, GND		1.65 to 5.5		0.10	10	μA

ELECTRICAL CHARACTERISTICS (continued)(Full = -40°C to +125°C, typical values are at T_A = +25°C, unless otherwise noted.)

PARAMETER	SYMBOL	CONDITIONS	MIN	TYP	MAX	UNITS
AC Performance						
Propagation Delay	t _{PHL} , t _{PLH}	V _{CC} = 1.65V	C _L = 15pF, R _L = 1MΩ, Figure 1, Figure 2		9.6	ns
		V _{CC} = 1.80V			7.9	
		V _{CC} = 2.50V ± 0.20V			4.9	
		V _{CC} = 3.30V ± 0.30V			3.7	
		V _{CC} = 5.00V ± 0.50V			2.8	
		V _{CC} = 3.30V ± 0.30V		C _L = 50pF, R _L = 500Ω, Figure 1, Figure 2		
		V _{CC} = 5.00V ± 0.50V			3.2	
Input Capacitance	C _{IN}	V _{CC} = 0V		4.0		pF
Power Dissipation Capacitance ⁽²⁾	C _{PD}	V _{CC} = 3.30V	Figure 3		16.0	pF
		V _{CC} = 5.00V			19.0	

NOTES:

- Unused input must be held high or low. It may not float.
- C_{PD} is defined as the value of the internal equivalent capacitance which is derived from dynamic operating current consumption (I_{CCD}) at no output loading and operating at 50% duty cycle (see Figure 3). C_{PD} is related to dynamic operating current I_{CCD} by the expression: I_{CCD} = (C_{PD}) (V_{CC}) (f_{IN}) + (I_{CC,Static}).

TEST CIRCUITS

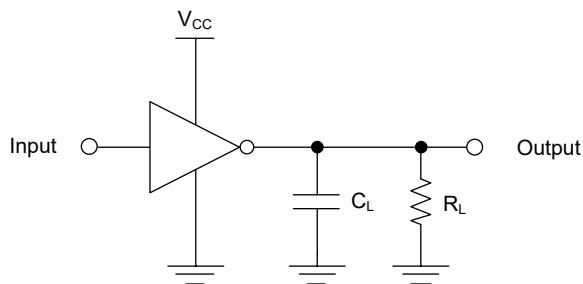

NOTE:
 R_L: Load resistance.
 C_L: Load and stray capacitance.
 Input PRR = 1.0MHz; t_w = 500ns.

Figure 1. AC Test Circuit

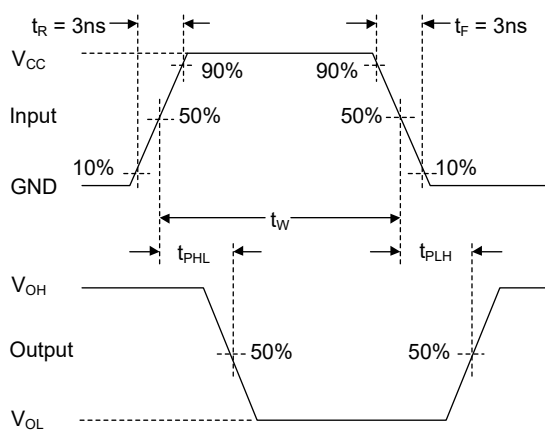
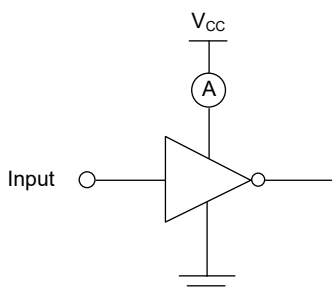

Figure 2. AC Waveforms



NOTE:
 Input = AC Waveform; t_r = t_f = 1.8ns; PRR = 10MHz; Duty Cycle = 50%.

Figure 3. I_{CCD} Test Circuit

REVISION HISTORY

NOTE: Page numbers for previous revisions may differ from page numbers in the current version.

SEPTEMBER 2022 – REV.A.3 to REV.A.4	Page
Updated Absolute Maximum Ratings section.....	2
SEPTEMBER 2021 – REV.A.2 to REV.A.3	Page
Updated Package Outline Dimensions section	8, 9
FEBRUARY 2021 – REV.A.1 to REV.A.2	Page
Changed operating temperature range	All
APRIL 2014 – REV.A to REV.A.1	Page
Added UTDFN-1.45×1-6L package.....	All
Changes from Original (OCTOBER 2013) to REV.A	Page
Changed from product preview to production data.....	All

PACKAGE INFORMATION

PACKAGE OUTLINE DIMENSIONS

SOT-23-5

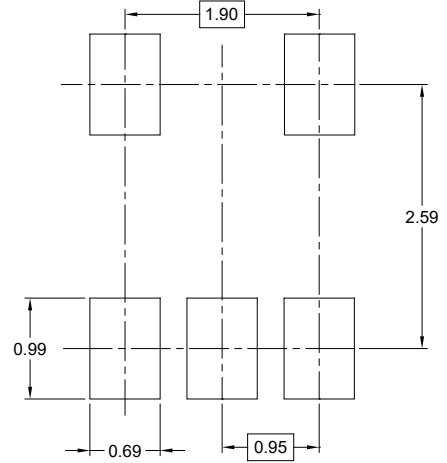
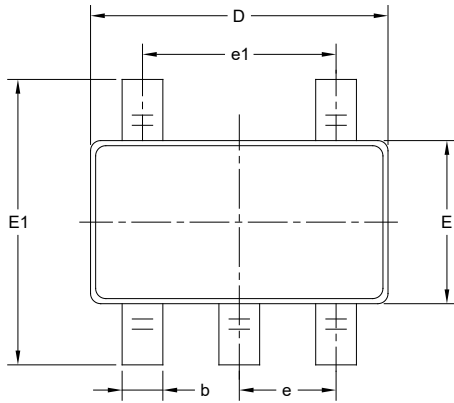

RECOMMENDED LAND PATTERN (Unit: mm)

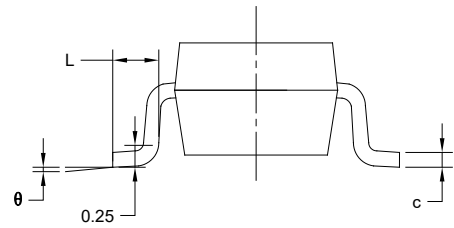
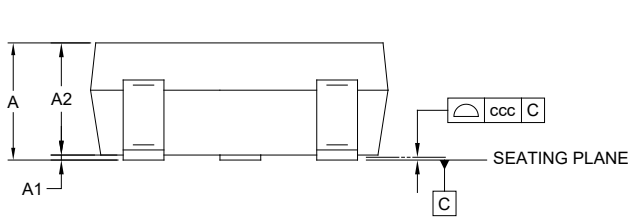

Symbol	Dimensions In Millimeters		
	MIN	MOD	MAX
A	-	-	1.450
A1	0.000	-	0.150
A2	0.900	-	1.300
b	0.300	-	0.500
c	0.080	-	0.220
D	2.750	-	3.050
E	1.450	-	1.750
E1	2.600	-	3.000
e	0.950 BSC		
e1	1.900 BSC		
L	0.300	-	0.600
θ	0°	-	8°
ccc	0.100		

NOTES:

1. This drawing is subject to change without notice.
2. The dimensions do not include mold flashes, protrusions or gate burrs.
3. Reference JEDEC MO-178.

PACKAGE OUTLINE DIMENSIONS

SC70-5

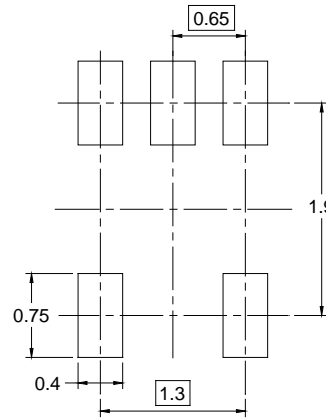
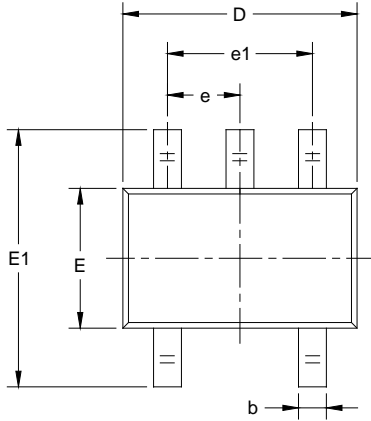

RECOMMENDED LAND PATTERN (Unit: mm)

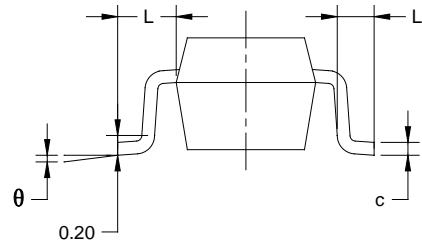
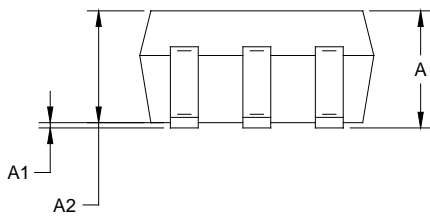

Symbol	Dimensions In Millimeters		Dimensions In Inches	
	MIN	MAX	MIN	MAX
A	0.800	1.100	0.031	0.043
A1	0.000	0.100	0.000	0.004
A2	0.800	1.000	0.031	0.039
b	0.150	0.350	0.006	0.014
c	0.080	0.220	0.003	0.009
D	2.000	2.200	0.079	0.087
E	1.150	1.350	0.045	0.053
E1	2.150	2.450	0.085	0.096
e	0.65 TYP		0.026 TYP	
e1	1.300 BSC		0.051 BSC	
L	0.525 REF		0.021 REF	
L1	0.260	0.460	0.010	0.018
θ	0°	8°	0°	8°

NOTES:

1. Body dimensions do not include mode flash or protrusion.
2. This drawing is subject to change without notice.

PACKAGE OUTLINE DIMENSIONS

UTDFN-1.45x1-6L

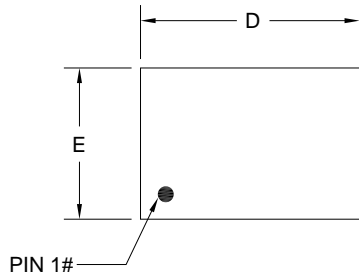

TOP VIEW

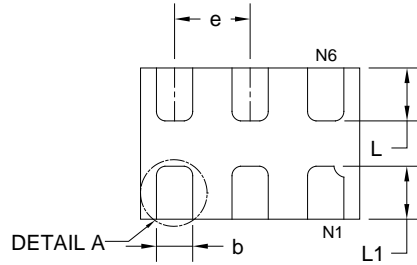

BOTTOM VIEW

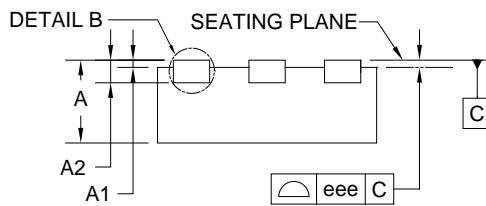

SIDE VIEW

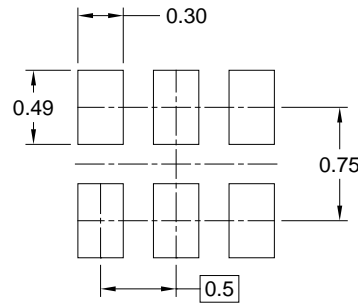

RECOMMENDED LAND PATTERN (Unit: mm)

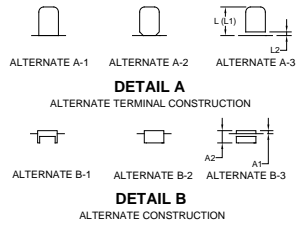

Symbol	Dimensions In Millimeters		Dimensions In Inches	
	MIN	MAX	MIN	MAX
A	0.450	0.600	0.018	0.024
A1	0.000	0.050	0.000	0.002
A2	0.150 REF		0.006 REF	
D	1.374	1.526	0.054	0.060
E	0.924	1.076	0.036	0.042
b	0.150	0.300	0.006	0.012
e	0.500 TYP		0.020 TYP	
eee	0.050		0.002	
L	0.250	0.450	0.010	0.018
L1	0.250	0.500	0.010	0.020
L2	0.000	0.100	0.000	0.004

NOTE: This drawing is subject to change without notice.

PACKAGE INFORMATION

TAPE AND REEL INFORMATION

REEL DIMENSIONS



TAPE DIMENSIONS



NOTE: The picture is only for reference. Please make the object as the standard.

KEY PARAMETER LIST OF TAPE AND REEL

Package Type	Reel Diameter	Reel Width W1 (mm)	A0 (mm)	B0 (mm)	K0 (mm)	P0 (mm)	P1 (mm)	P2 (mm)	W (mm)	Pin1 Quadrant
SOT-23-5	7"	9.5	3.20	3.20	1.40	4.0	4.0	2.0	8.0	Q3
SC70-5	7"	9.5	2.25	2.55	1.20	4.0	4.0	2.0	8.0	Q3
UTDFN-1.45×1-6L	7"	9.5	1.15	1.60	0.75	4.0	4.0	2.0	8.0	Q1

DD0001

PACKAGE INFORMATION

CARTON BOX DIMENSIONS



NOTE: The picture is only for reference. Please make the object as the standard.

KEY PARAMETER LIST OF CARTON BOX

Reel Type	Length (mm)	Width (mm)	Height (mm)	Pizza/Carton
7" (Option)	368	227	224	8
7"	442	410	224	18

DD0002