



KF66 Series High Density Right Angle PCB Mount with Ferrite

Ordering Information

KF66	-	E	15	S	-	N
Series	Shell Size	Number of Contacts	Contact Type	Mounting Options	Plating Options	
Series						
KF66 - Kycon High Density D-Subminiature Connector, Right Angle PCB Termination, .350 Footprint, with Ferrite						
KF66 - VESA - Contact factory for Specifications						
Shell Size, Number of Contacts						
E-15 Contacts						
A-26 Contacts						
B-44 Contacts						
C-62 Contacts						
Contact Type						
P-Pin Contact (Plug)						
S-Socket Contact (Receptacle)						
Mounting Options (see page 35)						
Plating Options and Performance Specifications (see page 4)						

Ferrite Specifications

Test Frequency	Outer Row	Inner Row
30 Mhz	20-23 Ohms	31-38 Ohms
50 Mhz	24-27 Ohms	37-43 Ohms
100 Mhz	29-31 Ohms	41-48 Ohms

Please see page 9 for recommended PCB layouts.

Note: Please check D and E dimensions on 62 contacts.

FERRITE D-SUBMINIATURE

KF66 Series

KF66 Series Dimensions

Pictured with Board Lock Option, Dimensions in mm [In]

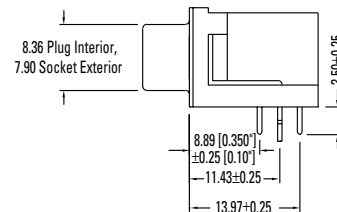
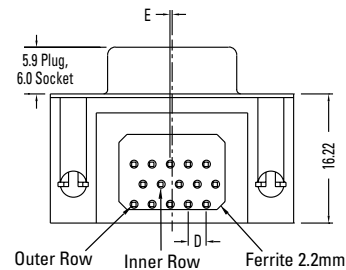
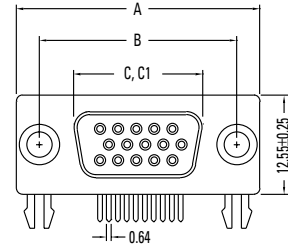

Shell Size	A	B	C	C1	D	E
	In	In	In	In	In	In
mm	mm	mm	mm	mm	mm	mm
15 (E)	1.213 30.81	.984 24.99	.643 16.33	.666 16.92	.090 2.29	.010 0.25
26 (A)	1.541 39.14	1.312 33.32	.971 24.66	.994 25.25	.090 2.29	.020 0.51
44 (B)	2.088 53.04	1.852 47.04	1.511 38.38	1.534 38.96	.090 2.29	.020 0.51
62 (C)	2.729 69.32	2.500 63.50	2.159 54.84	2.182 55.42	.095 2.41	.023 0.58

C = Exterior of Female Shell (S)

C1 = Interior of Male Shell (P)

Female (Receptacle): Top View

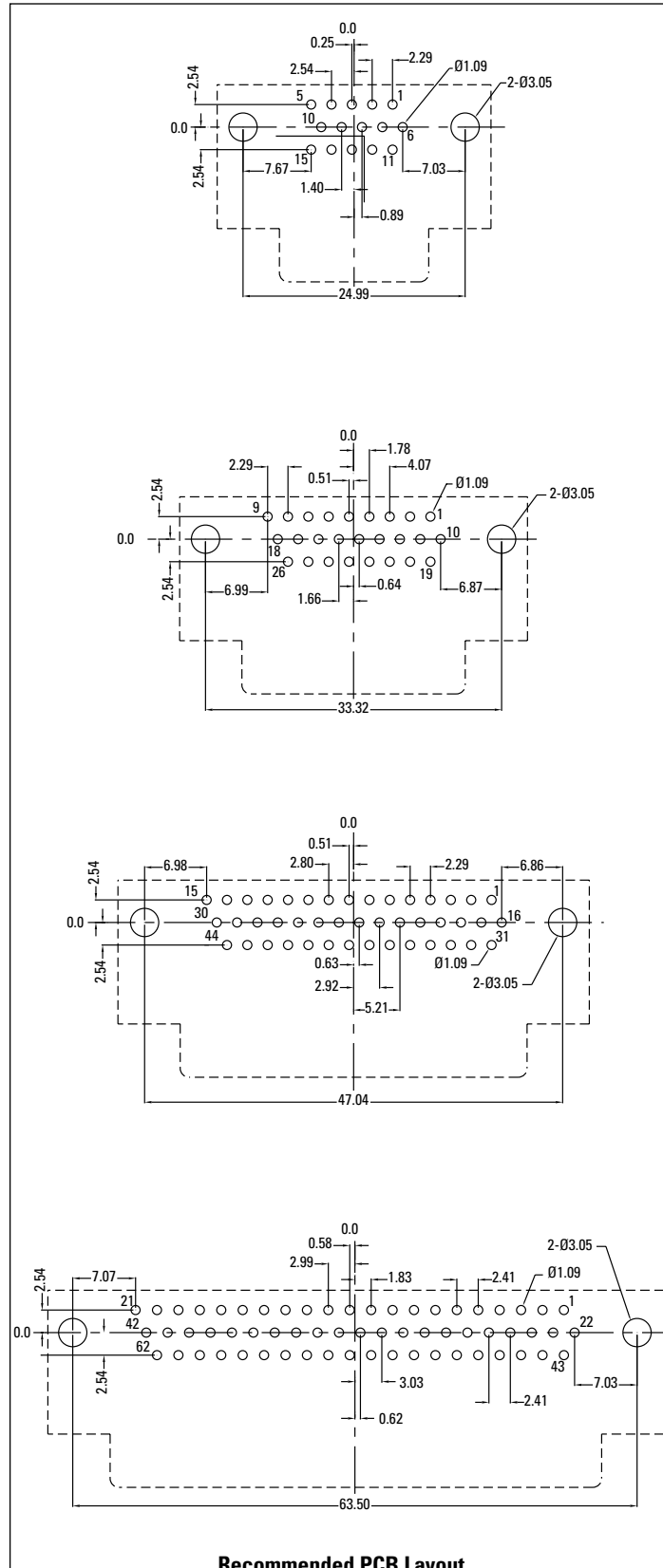

Male (Plug): Bottom View

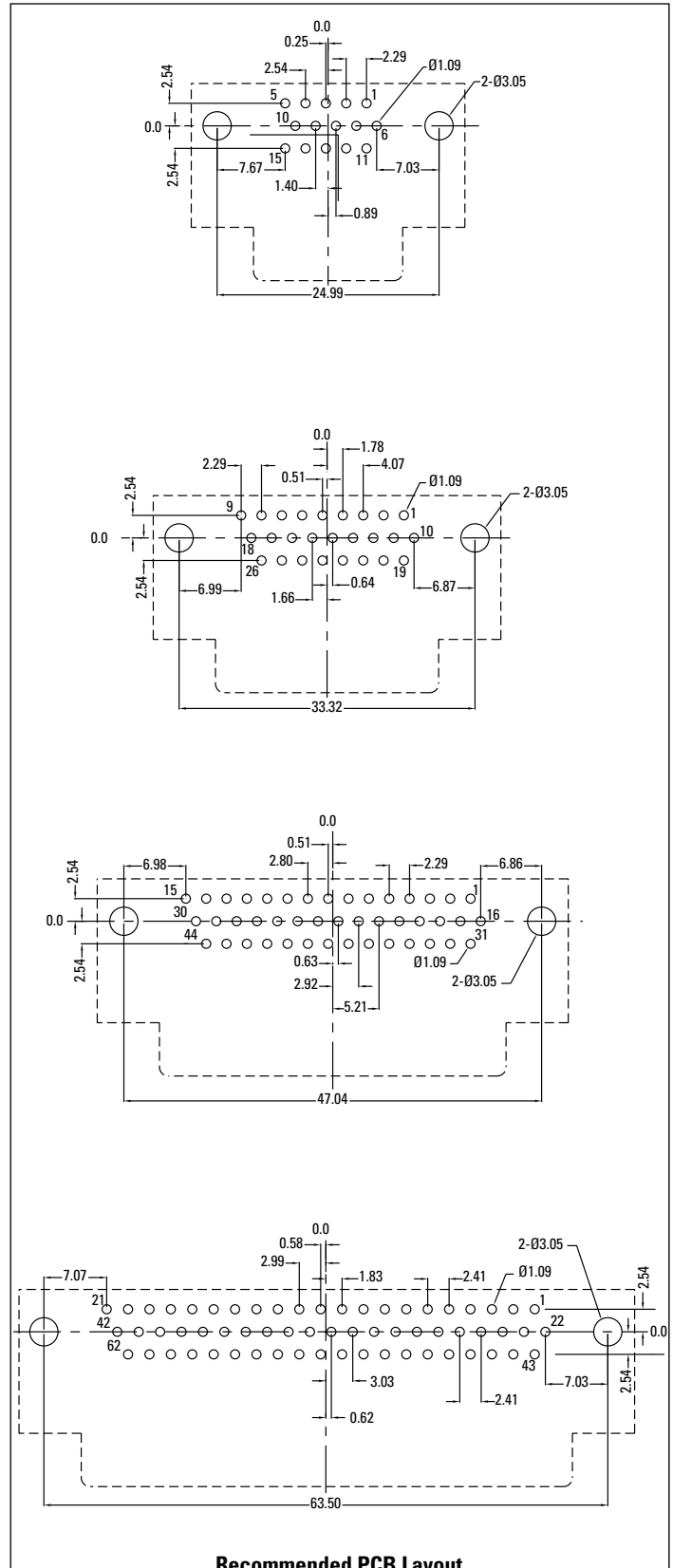

Mounting Options
K22, KF22,
K66, KF66

Front Panel Mounting Options	PCB Mounting Options			
	Grounding Board Locks	Top Only Grounding Straps with Non-Threaded .125" Diameter Mounting Holes	Wrap Around Grounding Straps with Non-Threaded .125" Diameter Mounting Holes (K22/KF22/Only)	4 Prong Board Locks
Riveted Threaded Inserts	N	H	O	NV
Riveted Threaded Inserts with 4-40 Hex. Jack Screws Installed	NJ	HJ	OJ	NVJ
4-40 Round Jackscrews Riveted to Connector	NR	HR	OR	NVR
Non-Threaded Riveted Inserts	NT	HT	OT	NVT
Riveted Threaded Inserts with M3/4-40 Hex. Jack Screws Installed	NJM	HJM	OJM	NVJM

PC Board Mounting Options

N Option

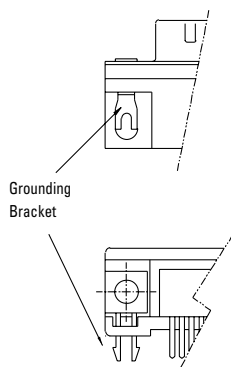

H Option

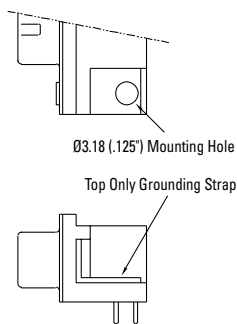

O Option

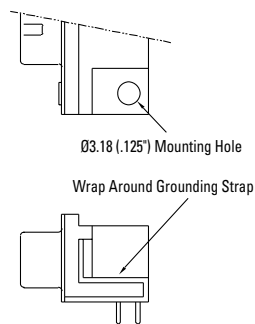

NV Option

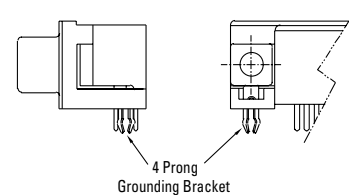

Front Panel Mounting Options

Standard

(4-40) Riveted Threaded Insert

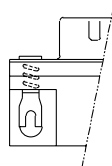

-J Option

(4-40) Riveted Threaded Insert with 4-40 Hex. JS1000 Jack Screws Installed to Connector

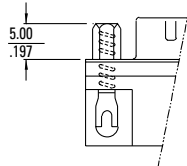

-R Option

(4-40) Round Jack Screws Riveted to Connector

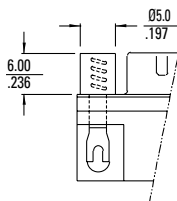

-T Option

Riveted Non-Threaded Insert 3.18/.125" Dia.

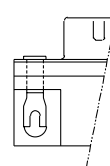

-JM Option

(4-40) Riveted Threaded Insert with M3/4-40 Hex. JS-M3131 Jack Screws Installed to Connector

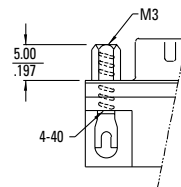

KYCON continues its leadership in D-Subminiature connectors by offering a complete line of sizes and options.

PC99 Colors Available:

- HD15: Blue
- DB15: Gold
- DB25: Burgundy
- DB09: Teal



D-SUBMINIATURE CONNECTORS

Performance Specifications

Materials and Finish

Shell

Steel Material, Tin Finish, and Indentations (Dimples) on Plug Only

Insert

Standard: PBT Thermoplastic, Black Color, 30% Glass Filled, 94V-0 Rated
 Reflow Compatible: High Temperature Thermoplastic, Black Color, 30% Glass Filled, 94V-0 Rated

Contact Material

Pin: Brass .040 (1.02) Diameter Standard; .030 (0.76) Diameter High Density
 Socket: Phosphor Bronze (Precision Formed Contact)
 Brass (Precision Machined Contact)

Contact Finish-Standard

Gold Flash Over 0.0001 (0.00254) Nickel on Mating End of Contacts
 Tin/Lead Over Nickel or Gold Flash Over Nickel on Solder Tails

Riveted Insert

Brass Material, Nickel Finish

Mechanical Characteristics

Contact Retention

Precision Machined Contact 10 Lbs, Precision Formed Contact 10 Lbs

Contact Extraction Force

Typ. 4 Oz.

Contact Insertion Force

Typ. 9 Oz.

Durability

1,000 Insertion Cycles Min (With Standard Plating)

Operating Temperature Rating

-55°C to +125°C

Electrical Characteristics

Contact Current Rating

Precision Machined Contact 7.6 Amps
 Precision Formed Contact 5.0 Amps (Except K99 Series)

Contact Resistance

Precision Machined Contact 5 Milliohms Max
 Precision Formed Contact 8 Milliohms Max

Dielectric Withstanding Voltage

1000 V AC Min for 1 Minute

Insulation Resistance

5000 Megohms Min

Processing Characteristics

Soldering Temperature Rating

High Temperature Plastic: 230°C for 30 Seconds, 260°C for 10 Seconds

Plating Options

Designator	Plating Description
Standard	Gold Flash over Nickel on Contacts. Gold Flash over Nickel or Tin/Lead over Nickel on Solder Tails.
15	15µ" Gold over Nickel on Mating End of Contacts. Tin/Lead over Nickel on Solder Tails.
30	30µ" Gold over Nickel on Mating End of Contacts. Tin/Lead over Nickel on Solder Tails.

KYCON continues its leadership in Ferrite D-Subs by offering a complete line of styles, sizes, and pin configurations.

Features:

- Applications include Computer Peripherals, Data Processing, Telecommunications, Industrial Controls, and Local Area Networks
- High performance ferrite filter with superior high frequency attenuation characteristics
- Minimal effect on fundamental waveforms
- EMI/RFI noise suppression in data communication lines
- Cost effective way to meet FCC and VDE Class B requirements
- Does not require any more board space than a standard D-Sub
- No need to redesign board layout to accommodate separate filter placement
- UL Recognized File No. E140125



FERRITE D-SUBMINIATURE CONNECTORS

Directory

Right Angle

<i>KF22 - 0.318" footprint</i>	28
<i>KF44 - 0.590" footprint</i>	29
<i>KF66 - High Density 0.350" footprint</i>	30
<i>KF42 - Dual Port</i>	31

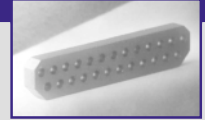

Vertical

<i>KF85 - Low Profile</i>	32
<i>KF86 - High Density</i>	33
<i>KF88 - High Profile</i>	34



Technical Information:

Ferrite filters provide an easy and efficient way of reducing both radiated and conducted interference. KYCON uses a medium permeability nickel zinc ferrite material that is most effective at attenuating frequencies above 30MHz.

$$Attenuation = 20 \log_{10} \frac{[Z_s + Z_f + Z_L]}{[Z_s + Z_L]} \text{ dB}$$

Where Z_s = Source Impedance
 Z_f = Ferrite Impedance
 Z_L = Load Impedance

With the above impedance values calculated at the interference frequency.

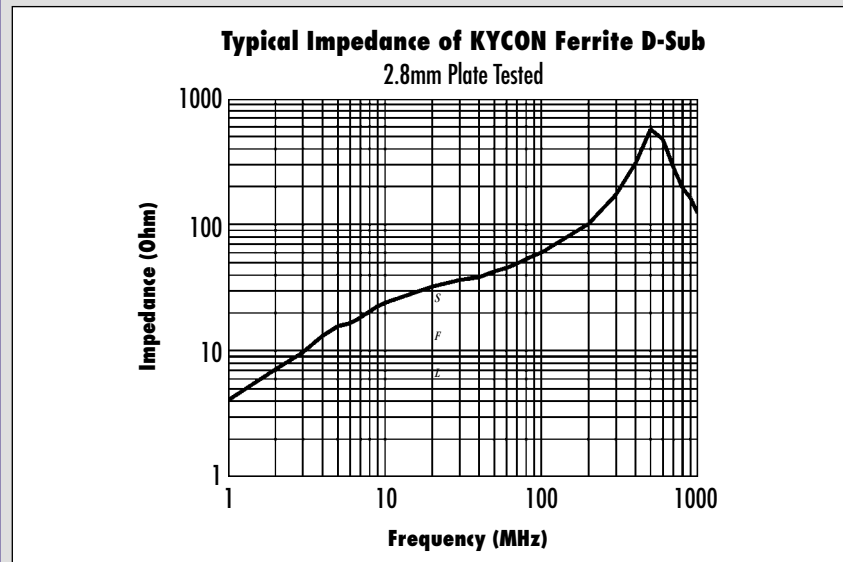

The above chart is typical performance data for a 2.8mm thick ferrite plate at room temperature. Impedance will be reduced by increased temperature (down approx. 15% at 100°C at 25MHz) and by increased DC bias (down approx. 15% at 1 amp at 25MHz). Also, impedance varies with ferrite thickness. Please contact our technical support for data specific to your application.

KYCON Tech Support: **1-888-KYCON-22**
 or E-mail: sales@kycon.com

Mouser Electronics

Authorized Distributor

Click to View Pricing, Inventory, Delivery & Lifecycle Information:

Kycon:

[KF66SP-E15S-N](#) [KF66-C62S-NVJ](#) [KF66-A26S-NJ15](#) [KF66-C62P-NJ](#) [KF66-B44S-NR30](#) [KF66-E15S-NR](#) [KF66-E15S-NT](#) [KF66-E15S-ND](#) [KF66-E15S-NV](#) [KF66-E15S-NV30](#) [KF66-B44S-NJ15](#) [KF66-B44S-NJ30](#) [KF66-B44S-HR30](#) [KF66-A26S-NV](#) [KF66-A26S-NT](#) [KF66-B44S-HR15](#) [KF66-A26S-HT](#) [KF66-A26S-HR](#) [KF66-E15S-HR15](#) [KF66-A26P-HR](#) [KF66-B44S-NT](#) [KF66-B44S-HR](#) [KF66-B44S-HJ](#) [KF66-B44S-HT](#) [KF66-B44S-NR](#) [KF66-B44S-N15](#) [KF66-C62S-NJ30](#) [KF66-E15S-NR30](#) [KF66-B44P-NJ](#) [KF66-E15S-NR15](#) [KF66-B44S-N30](#) [KF66-C62S-NJ15](#) [KF66-C62P-N30](#) [KF66-C62P-N15](#) [KF66-B44P-NT30](#) [KF66-E15S-H](#) [KF66-B44P-N](#) [KF66-A26S-H](#) [KF66-E15S-H30](#) [KF66-C62S-N](#) [KF66-E15S-H15](#) [KF66-E15S-HJ15](#) [KF66-E15S-HJ30](#) [KF66-E15S-N30](#) [KF66-E15S-N15](#) [KF66-B44S-HJ30](#) [KF66-B44S-HJ15](#) [KF66-E15P-H](#) [KF66-E15P-N](#) [KF66-B44S-NVJ30](#) [KF66-E15S-NT15](#) [KF66-E15S-NT30](#) [KF66-B44S-H](#) [KF66-B44S-NT15](#) [KF66-B44S-NT30](#) [KF66-C62S-N30](#) [KF66-E15P-NT](#) [KF66-E15P-HR](#) [KF66-E15P-HT](#) [KF66-E15S-NR-VESA](#) [KF66-B44P-NJ15](#) [KF66-C62S-HJ](#) [KF66-C62S-NJ](#) [KF66-A26S-NJ30](#) [KF66-E15S-NJ15](#) [KF66-E15S-NJ30](#) [KF66-C62S-N15](#) [KF66-B44S-NR15](#) [KF66-E15S-HJ](#) [KF66-E15S-HT](#) [KF66-E15S-HR](#) [KF66-A26S-N30](#) [KF66-E15S-HR30](#) [KF66-B44S-HT15](#) [KF66-B44S-HT30](#) [KF66-B44P-N15](#) [KF66-B44P-N30](#) [KF66-A26S-N15](#) [KF66-E15S-NJ-VESA](#) [KF66-B44S-H15](#) [KF66-B44S-H30](#) [KF66-E15S-NJM](#) [KF66-E15S-NVJ-VESA](#) [KF66-E15P-H30](#) [KF66-E15P-H15](#) [KF66-C62P-NJ15](#) [KF66-C62P-NJ30](#) [KF66-E15S-HT15](#) [KF66-E15S-HT30](#) [KF66-A26P-N15](#) [KF66-A26P-N30](#) [KF66-B44P-NJ30](#) [KF66-E15P-NJ30](#) [KF66-E15P-NJ15](#) [KF66-A26P-NJ15](#) [KF66-A26P-NJ30](#) [KF66-C62P-N](#) [KF66-E15P-N15](#) [KF66-C62P-H](#) [KF66-E15P-N30](#)