

NCP4420, NCP4429

6 A High-Speed MOSFET Drivers

The NCP4420/NCP4429 are 6 A (peak), single output, MOSFET drivers. The NCP4429 is an inverting driver while the NCP4420 is a non-inverting driver. These drivers are fabricated in CMOS for lower power and more efficient operation versus bipolar drivers.

Both drivers have TTL-compatible inputs, which can be driven as high as $V_{DD} + 0.3$ V or as low as -5 V without upset or damage to the device. This eliminates the need for external level shifting circuitry and its associated cost and size. The output swing is rail-to-rail ensuring better drive voltage margin, especially during power up/power down sequencing. Propagational delay time is only 55 nsec (typ.) and the output rise and fall times are only 25 nsec (typ.) into 2500 pF across the useable power supply range.

Unlike other drivers, the NCP4420/NCP4429 are virtually latch-up proof. They can replace three or more discrete components saving PCB area, costs and improving overall system reliability.

Features

- Latch-Up Protected: Will Withstand > 1.5 A Reverse Output Current
- Logic Input Will Withstand Negative Swing Up to 5 V
- ESD Protected (4 kV)
- Matched Rise and Fall Times (25 nsec)
- High Peak Output Current (6 A Peak)
- Wide Operating Range (4.5 V to 18 V)
- High Capacitive Load Drive (10,000 pF)
- Short Delay Time (55 nsec Typ)
- Logic High Input, any Voltage (2.4 V to V_{DD})
- Low Supply Current with Logic "1" Input (450 μ A)
- Low Output Impedance (2.5 Ω)
- Output Voltage Swing to within 25 mV of Ground or V_{DD}
- Temperature Range -40°C to $+85^{\circ}\text{C}$

Applications

- Switch-Mode Power Supplies
- Motor Controls
- Pulse Transformer Driver
- Class D Switching Amplifiers



ON Semiconductor®

<http://onsemi.com>



SO-8
D SUFFIX
CASE 751

MARKING DIAGRAM

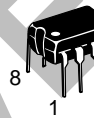

PDIP-8
P SUFFIX
CASE 626

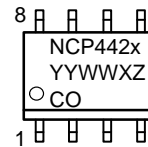

x = Device Number (0 or 9)
YY, Y = Year
WW = Work Week
X = Assembly ID Code
Z = Subcontractor ID Code
CO = Country of Origin

PIN CONNECTIONS

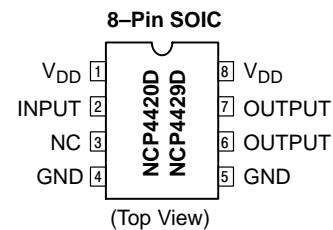

ORDERING INFORMATION

Device	Package	Shipping
NCP4420DR2 Non-Inverting	SO-8	2500 Tape & Reel
NCP4429DR2 Inverting	SO-8	2500 Tape & Reel
NCP4420P Non-Inverting	PDIP-8	50 Units/Rail
NCP4429P Inverting	PDIP-8	50 Units/Rail

NCP4420, NCP4429

FUNCTIONAL BLOCK DIAGRAM

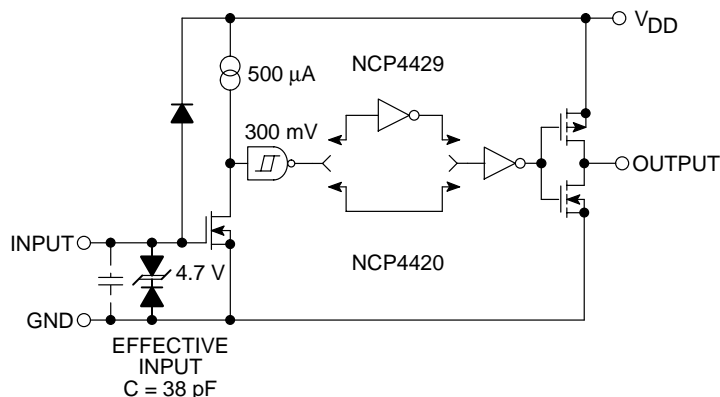

ABSOLUTE MAXIMUM RATINGS*

Rating	Value	Unit
Supply Voltage	+20	V
Input Voltage	-5.0 to V_{DD}	V
Input Current ($V_{IN} > V_{DD}$)	50	mA
Power Dissipation, $T_A \leq 70^\circ\text{C}$		mW
SOIC	470	
PDIP	730	
Derating Factors (To Ambient)		mW/ $^\circ\text{C}$
SOIC	4.0	
PDIP	8.0	
Storage Temperature Range, T_{stg}	-65 to +150	$^\circ\text{C}$
Operating Temperature (Chip)	+150	$^\circ\text{C}$
Operating Temperature Range (Ambient), T_A	-40 to +85	$^\circ\text{C}$
Lead Temperature (Soldering, 10 sec)	+300	$^\circ\text{C}$

*Static-sensitive device. Unused devices must be stored in conductive material. Protect devices from static discharge and static fields. Stresses above those listed under "Absolute Maximum Ratings" may cause permanent damage to the device. These are stress ratings only, and functional operation of the device at these or any other conditions above those indicated in the operational sections of the specifications is not implied. Exposure to absolute maximum rating conditions for extended periods may affect device reliability.

ELECTRICAL CHARACTERISTICS ($T_A = +25^\circ\text{C}$ with $4.5\text{ V} \leq V_{DD} \leq 18\text{ V}$, unless otherwise specified.)

Characteristic	Symbol	Test Conditions	Min	Typ	Max	Unit
Input						
Logic 1 High Input Voltage	V_{IH}	-	2.4	1.8	-	V
Logic 0 Low Input Voltage	V_{IL}	-	-	1.3	0.8	V
Input Voltage Range	$V_{IN} (\text{Max})$	-	-5.0	-	$V_{DD} + 0.3$	V
Input Current	I_{IN}	$0\text{ V} \leq V_{IN} \leq V_{DD}$	-10	-	10	μA
Output						
High Output Voltage	V_{OH}	See Figure 1	$V_{DD} - 0.025$	-	-	V
Low Output Voltage	V_{OL}	See Figure 1	-	-	0.025	V
Output Resistance, High	R_{OH}	$I_{OUT} = 10\text{ mA}$, $V_{DD} = 18\text{ V}$	-	2.1	2.8	Ω
Output Resistance, Low	R_{OL}	$I_{OUT} = 10\text{ mA}$, $V_{DD} = 18\text{ V}$	-	1.5	2.5	Ω

NCP4420, NCP4429

Characteristic	Symbol	Test Conditions	Min	Typ	Max	Unit
----------------	--------	-----------------	-----	-----	-----	------

Output

Peak Output Current	I_{PK}	$V_{DD} = 18\text{ V}$ (See Figure 5)	–	6.0	–	A
Latch-Up Protection Withstand Reverse Current	I_{REV}	Duty Cycle $\leq 2\%$ $t \leq 300\ \mu\text{s}$	1.5	–	–	A

Switching Time (Note 1)

Rise Time	t_R	Figure 1, $C_L = 2500\ \text{pF}$	–	25	35	nsec
Fall Time	t_F	Figure 1, $C_L = 2500\ \text{pF}$	–	25	35	nsec
Delay Time 1	t_{D1}	Figure 1	–	55	75	nsec
Delay Time 2	t_{D2}	Figure 1	–	55	75	nsec

Power Supply

Power Supply Current	I_S	$V_{IN} = 3.0\ \text{V}$ $V_{IN} = 0\ \text{V}$	– –	0.45 55	1.5 150	mA μA
Operating Input Voltage	V_{DD}	–	4.5	–	18	V

1. Switching times guaranteed by design.

ELECTRICAL CHARACTERISTICS (Measured over operating temperature range with $4.5\ \text{V} \leq V_{DD} \leq 18\ \text{V}$, unless otherwise specified.)

Characteristic	Symbol	Test Conditions	Min	Typ	Max	Unit
----------------	--------	-----------------	-----	-----	-----	------

Input

Logic 1 High Input Voltage	V_{IH}	–	2.4	–	–	V
Logic 0 Low Input Voltage	V_{IL}	–	–	–	0.8	V
Input Voltage Range	$V_{IN}(\text{Max})$	–	–5.0	–	$V_{DD} + 0.3$	V
Input Current	I_{IN}	$0\ \text{V} \leq V_{IN} \leq V_{DD}$	–10	–	10	μA

Output

High Output Voltage	V_{OH}	See Figure 1	$V_{DD} - 0.025$	–	–	V
Low Output Voltage	V_{OL}	See Figure 1	–	–	0.025	V
Output Resistance, High	R_{OH}	$I_{OUT} = 10\ \text{mA}$, $V_{DD} = 18\ \text{V}$	–	3.0	5.0	Ω
Output Resistance, Low	R_{OL}	$I_{OUT} = 10\ \text{mA}$, $V_{DD} = 18\ \text{V}$	–	2.3	5.0	Ω

Switching Time (Note 1)

Rise Time	t_R	Figure 1, $C_L = 2500\ \text{pF}$	–	32	60	nsec
Fall Time	t_F	Figure 1, $C_L = 2500\ \text{pF}$	–	34	60	nsec
Delay Time 1	t_{D1}	Figure 1	–	50	100	nsec
Delay Time 2	t_{D2}	Figure 1	–	65	100	nsec

Power Supply

Power Supply Current	I_S	$V_{IN} = 3.0\ \text{V}$ $V_{IN} = 0\ \text{V}$	– –	0.45 60	3.0 400	mA μA
Operating Input Voltage	V_{DD}	–	4.5	–	18	V

1. Switching times guaranteed by design.

NCP4420, NCP4429

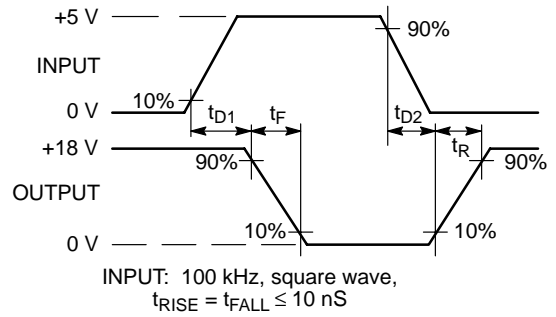
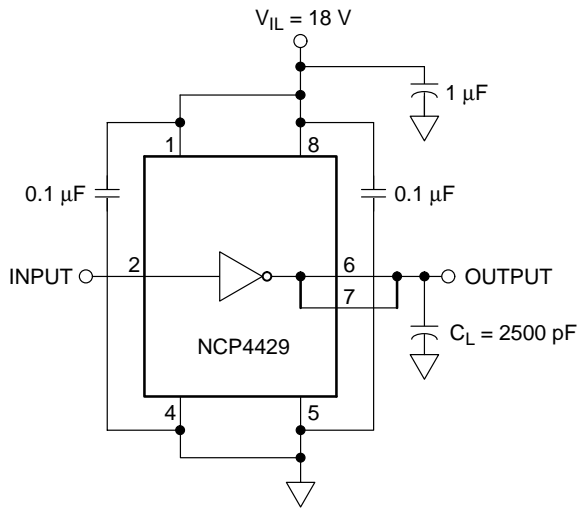

Figure 1. Switching Time Test Circuit

TYPICAL CHARACTERISTICS

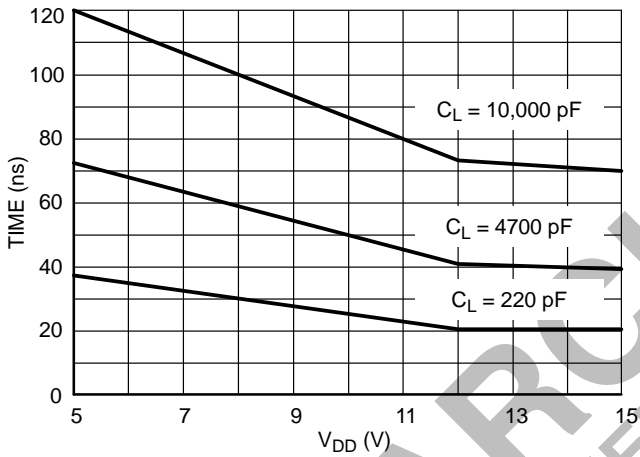

Figure 2. Rise Time vs. Supply Voltage

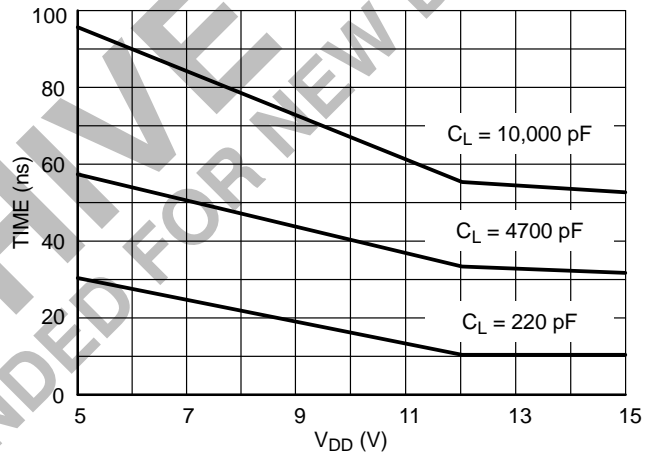

Figure 3. Fall Time vs. Supply Voltage

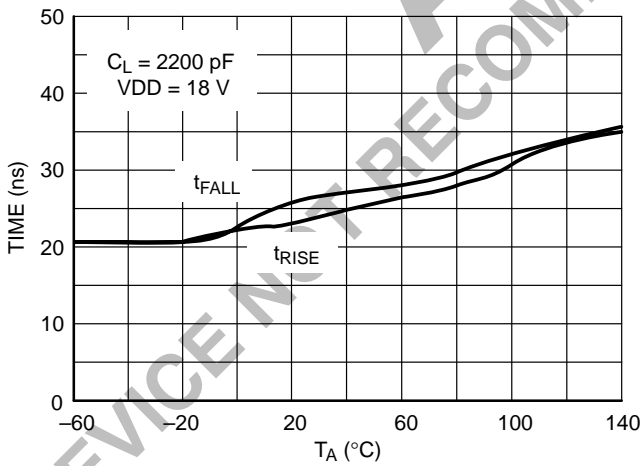

Figure 4. Rise and Fall Times vs. Temperature

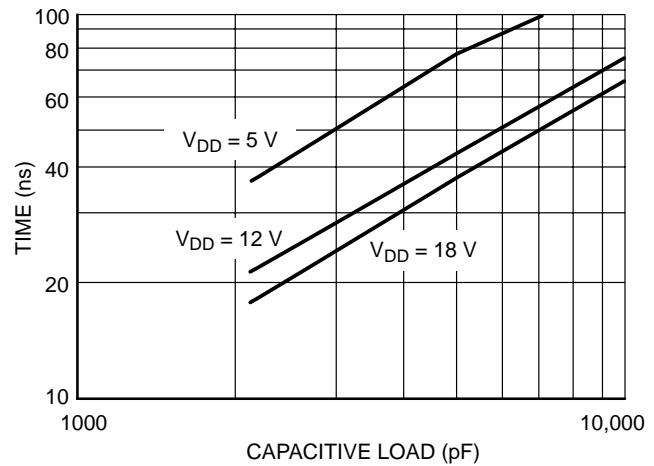

Figure 5. Rise Time vs. Capacitive Load

NCP4420, NCP4429

TYPICAL CHARACTERISTICS

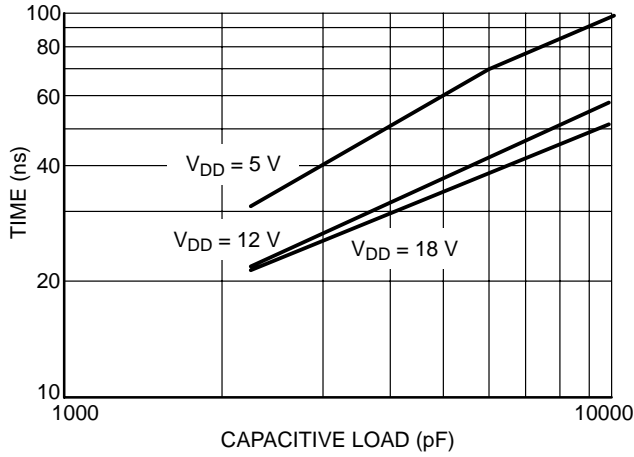

Figure 6. Fall Time vs. Capacitive Load

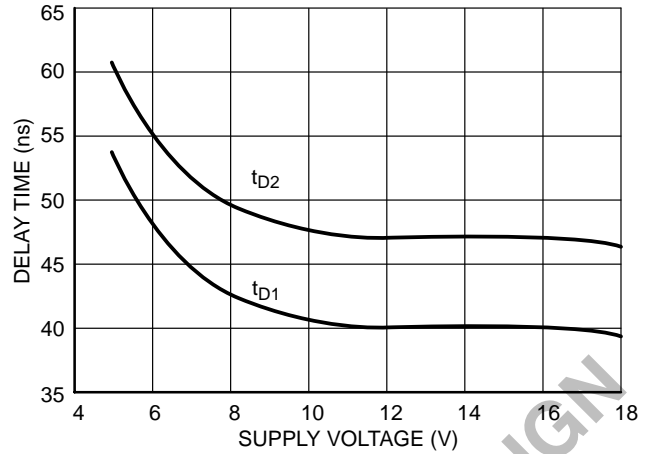

Figure 7. Propagation Delay Time vs. Supply Voltage

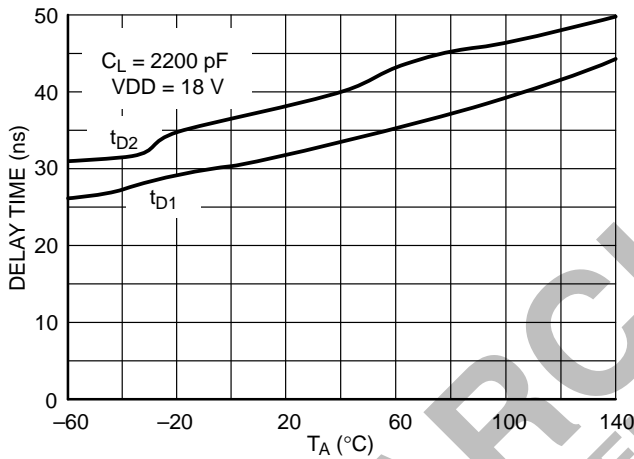

Figure 8. Propagation Delay Time vs. Temperature

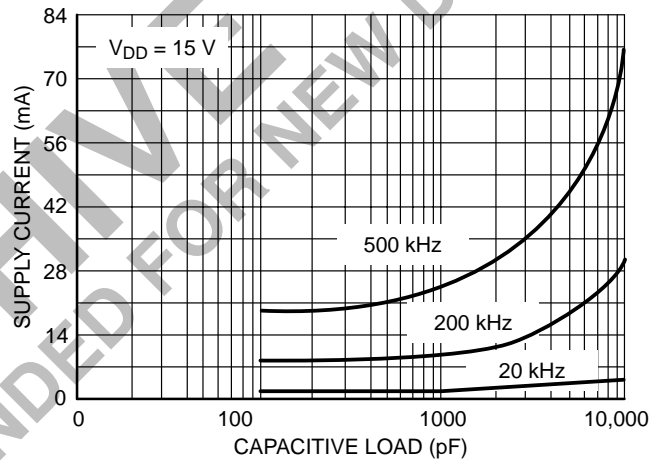

Figure 9. Supply Current vs. Capacitive Load

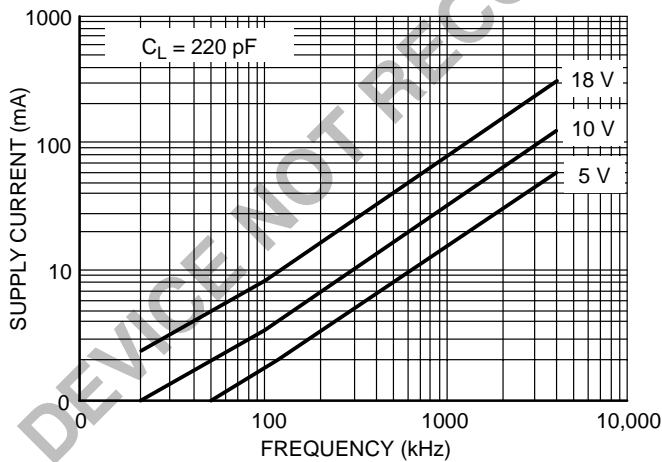

Figure 10. Supply Current vs. Frequency

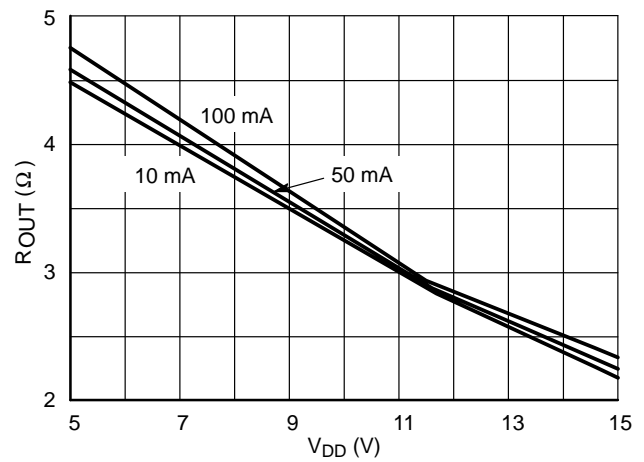

Figure 11. High-State Output Resistance

NCP4420, NCP4429

TYPICAL CHARACTERISTICS

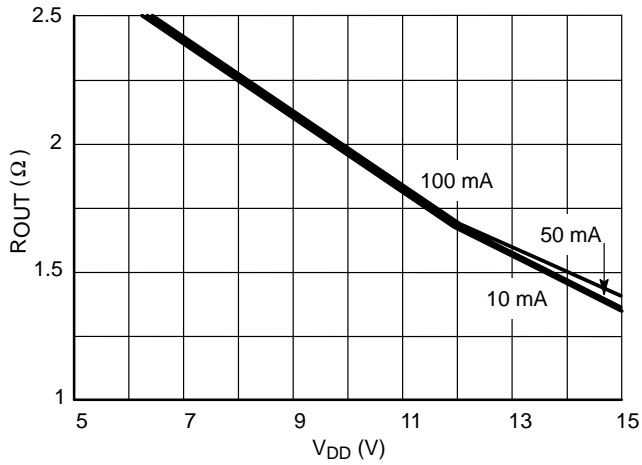

Figure 12. Low-State Output Resistance

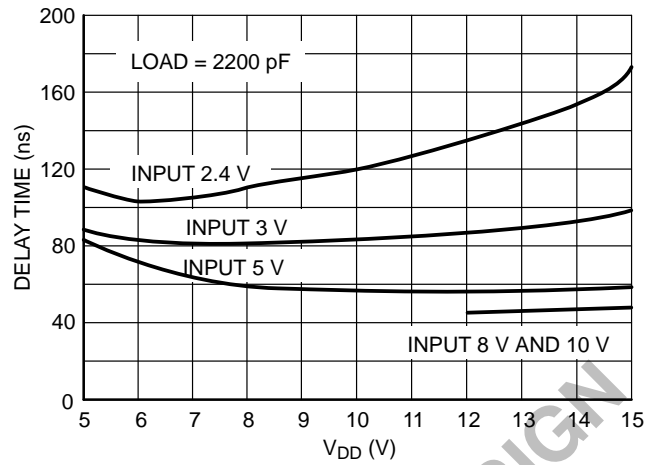

Figure 13. Effect of Input Amplitude on Propagation Delay

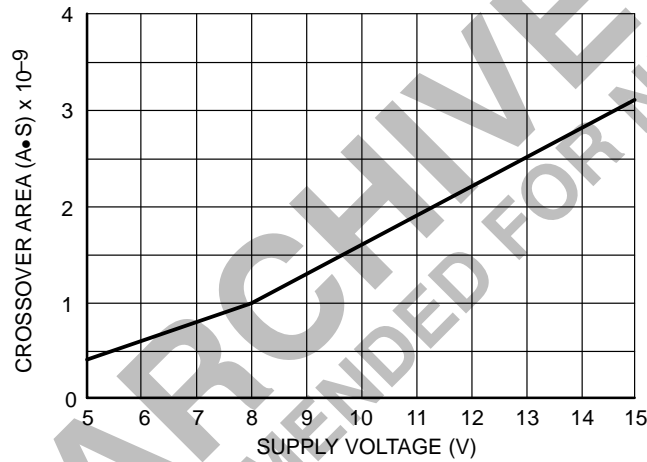

Figure 14. Total nA•S Crossover*

* The values on this graph represent the loss seen by the driver during one complete cycle. For a single transition, divide the value by 2.

ARCHIVE FOR NEW DESIGN
DEVICE NOT RECOMMENDED

NCP4420, NCP4429

PACKAGE DIMENSIONS

PDIP-8
P SUFFIX
CASE 626-05
ISSUE K

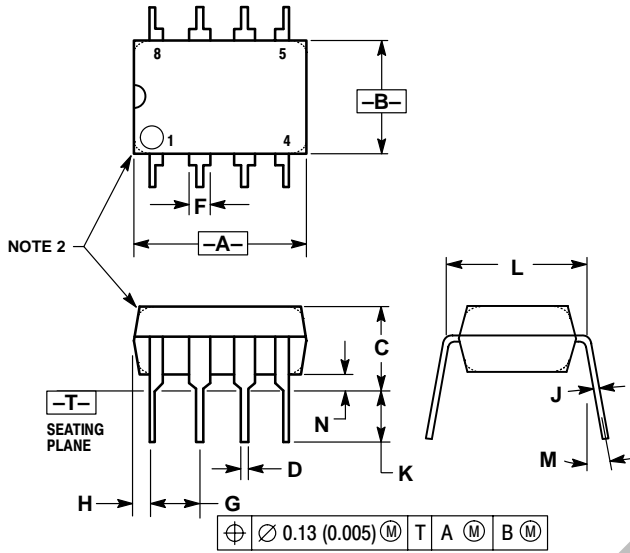

NOTES:

1. DIMENSION L TO CENTER OF LEAD WHEN FORMED PARALLEL.
2. PACKAGE CONTOUR OPTIONAL (ROUND OR SQUARE CORNERS).
3. DIMENSIONING AND TOLERANCING PER ANSI Y14.5M, 1982.

DIM	MILLIMETERS		INCHES	
	MIN	MAX	MIN	MAX
A	9.40	10.16	0.370	0.400
B	6.10	6.60	0.240	0.260
C	3.94	4.45	0.155	0.175
D	0.38	0.51	0.015	0.020
F	1.02	1.78	0.040	0.070
G	2.54 BSC		0.100 BSC	
H	0.76	1.27	0.030	0.050
J	0.20	0.30	0.008	0.012
K	2.92	3.43	0.115	0.135
L	7.62 BSC		0.300 BSC	
M	---	10°	---	10°
N	0.76	1.01	0.030	0.040

SO-8
D SUFFIX
CASE 751-06
ISSUE T

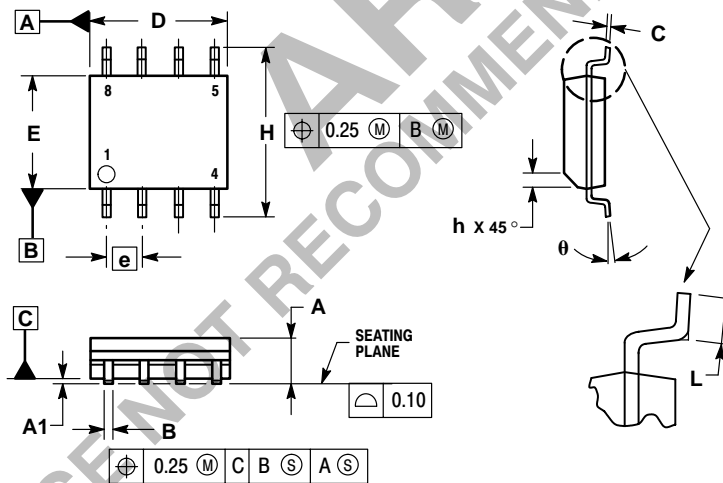

NOTES:

1. DIMENSIONING AND TOLERANCING PER ASME Y14.5M, 1994.
2. DIMENSIONS ARE IN MILLIMETER.
3. DIMENSION D AND E DO NOT INCLUDE MOLD PROTRUSION.
4. MAXIMUM MOLD PROTRUSION 0.15 PER SIDE.
5. DIMENSION B DOES NOT INCLUDE DAMBAR PROTRUSION. ALLOWABLE DAMBAR PROTRUSION SHALL BE 0.127 TOTAL IN EXCESS OF THE B DIMENSION AT MAXIMUM MATERIAL CONDITION.

DIM	MILLIMETERS	
	MIN	MAX
A	1.35	1.75
A1	0.10	0.25
B	0.35	0.49
C	0.19	0.25
D	4.80	5.00
E	3.80	4.00
e	1.27 BSC	
H	5.80	6.20
h	0.25	0.50
L	0.40	1.25
θ	0°	7°

ARCHIVE
RECOMMENDED FOR NEW DESIGN

ON Semiconductor and  are registered trademarks of Semiconductor Components Industries, LLC (SCILLC). SCILLC reserves the right to make changes without further notice to any products herein. SCILLC makes no warranty, representation or guarantee regarding the suitability of its products for any particular purpose, nor does SCILLC assume any liability arising out of the application or use of any product or circuit, and specifically disclaims any and all liability, including without limitation special, consequential or incidental damages. "Typical" parameters which may be provided in SCILLC data sheets and/or specifications can and do vary in different applications and actual performance may vary over time. All operating parameters, including "Typicals" must be validated for each customer application by customer's technical experts. SCILLC does not convey any license under its patent rights nor the rights of others. SCILLC products are not designed, intended, or authorized for use as components in systems intended for surgical implant into the body, or other applications intended to support or sustain life, or for any other application in which the failure of the SCILLC product could create a situation where personal injury or death may occur. Should Buyer purchase or use SCILLC products for any such unintended or unauthorized application, Buyer shall indemnify and hold SCILLC and its officers, employees, subsidiaries, affiliates, and distributors harmless against all claims, costs, damages, and expenses, and reasonable attorney fees arising out of, directly or indirectly, any claim of personal injury or death associated with such unintended or unauthorized use, even if such claim alleges that SCILLC was negligent regarding the design or manufacture of the part. SCILLC is an Equal Opportunity/Affirmative Action Employer.

PUBLICATION ORDERING INFORMATION

Literature Fulfillment:

Literature Distribution Center for ON Semiconductor
P.O. Box 5163, Denver, Colorado 80217 USA
Phone: 303-675-2175 or 800-344-3860 Toll Free USA/Canada
Fax: 303-675-2176 or 800-344-3867 Toll Free USA/Canada
Email: ONlit@hibbertco.com

N. American Technical Support: 800-282-9855 Toll Free USA/Canada

JAPAN: ON Semiconductor, Japan Customer Focus Center
2-9-1 Kamimeguro, Meguro-ku, Tokyo, Japan 153-0051
Phone: 81-3-5773-3850
Email: r14525@onsemi.com

ON Semiconductor Website: <http://onsemi.com>

For additional information, please contact your local Sales Representative.