

FEATURES

- Ultra Low ESR and High Ripple Current Ratings
- Values from 3.3 μ F to 1,000 μ F
- Suitable for Reflow Soldering (+260°C)
- Available in A, B2, B, C, V and D Case Sizes

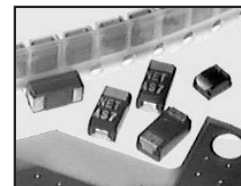

CHARACTERISTICS

Capacitance Range	3.3 μ F to 1000 μ F	
Capacitance Tolerance	\pm 20% (M)	
Rated Voltage Range @ 85°C (Vdc)	2.5Vdc ~ 25Vdc*	
Operating Temperature Range	-55°C ~ +105°C (voltage derating above +85°C, see table below)	
Dissipation Factor	See Specifications Table	
Leakage Current @ +25°C (After 5 Minutes at Rated Voltage)	Not More Than 0.1CV or 3 μ A, whichever is greater	
Capacitance Change With Temperature	-55°C	+105°C
	Δ C - 20%	Δ C +50%
Resistance to Soldering Heat (+240°C for 5 ~ 10 Seconds)	Δ C \pm 20% Max, LC = Less than initial specification DF = 130% of initial measured value	
Moisture Resistance (500 hours; 90~95% RH @ 40°C)	Δ C +30% ~ -20% Max, LC = Less than initial specification DF = 130% of initial measured value	
Load Life at Rated Voltage (1,000 hours @ 85°C)	Δ C +30% Max, LC = Less than initial specification DF = 150% of initial measured value	
Base Failure Rate	1%/1000 hours at +85°C and rated voltage	

* It is recommended that the applied voltage be less than 80% of the rated voltage

STANDARD VALUES AND CASE SIZES

Rated Voltage @ +85°C	2.5	4.0	6.3	10	16	20	25
Surge Voltage @ +85°C	3.3	5.2	8.0	13	20	23	29
Derated Voltage @ 105°C	2.0	3.3	5.0	8.0	12.8	16	20
Capacitance (μ F)	Code	Case Size	Case Size	Case Size	Case Size	Case Size	Case Size
3.3	335	-	-	-	A	A	-
4.7	475	-	-	-	A	B	-
6.8	685	-	-	-	A	B	B
10	106	-	-	A	A, B	B	-
15	156	-	-	A	A	-	V
22	226	-	B	A, B2	A, B2, B	-	V
33	336	-	A	A, B2, B	A, B2, B	V	-
47	476	-	A, B2	A, B2, B	B2, B, C	V, D	-
68	686	-	A	B2, B, C	C, V, D	V, D	-
100	107	-	A	A, B2, B, C, V	B, C, V, D	-	-
150	157	-	-	B2, B, C, V, D	C, V, D	-	-
220	227	A, B	V, D	B, V, D	D	-	-
330	337	B, C, V	C, V, D	B, V, D	-	-	-
470	477	V	D	-	-	-	-
680	687	D	D	-	-	-	-
1000	108	D	-	-	-	-	-

PART NUMBER SYSTEM

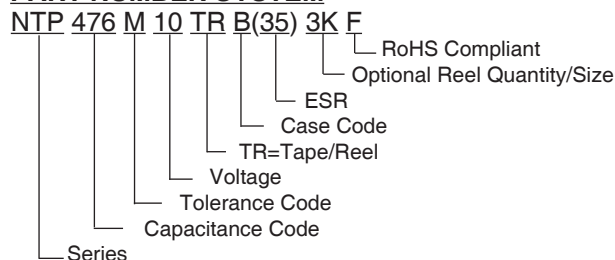

Surface Mount Polymer-Tantalum Capacitor

NTP Series

MAX. ESR (mΩ) @ 20°C/100KHz AND RIPPLE CURRENT (mArms) @20°C/100KHz

NIC Part Number	Capacitance Value (μF)	Working Voltage (Vdc)	Dissipation Factor @ +20°C/120Hz	ESR (mΩ) @+20°C/100KHz	Ripple Current Rating (mA) @ +20°C/100KHz
NTP227M2.5TRA(45)F	220	2.5	0.08	45	1291
NTP227M2.5TRA(35)F	220		0.08	35	1464
NTP227M2.5TRA(25)F	220		0.08	25	1732
NTP227M2.5TRB(45)F	220		0.08	45	1374
NTP227M2.5TRB(35)F	220		0.08	35	1558
NTP227M2.5TRB(25)F	220		0.08	25	1844
NTP227M2.5TRB(21)F	220		0.08	21	2011
NTP227M2.5TRB(15)F	220		0.08	15	2380
NTP337M2.5TRB(45)F	330		0.08	45	1374
NTP337M2.5TRB(35)F	330		0.08	35	1558
NTP337M2.5TRB(21)F	330		0.08	21	2011
NTP337M2.5TRB(15)F	330		0.08	15	2380
NTP337M2.5TRB(9)F	330		0.08	9	3073
NTP337M2.5TRC(55)F	330		0.08	55	1414
NTP337M2.5TRC(45)F	330		0.10	45	1563
NTP337M2.5TRC(25)F	330		0.10	25	2345
NTP337M2.5TRC(18)F	330		0.10	18	2472
NTP337M2.5TRV(25)F	330		0.10	25	2236
NTP337M2.5TRV(15)F	330		0.10	15	2887
NTP337M2.5TRV(12)F	330		0.10	12	3227
NTP337M2.5TRV(9)F	330		0.10	9	3726
NTP477M2.5TRV(15)F	470		0.10	15	2887
NTP477M2.5TRV(12)F	470		0.10	12	3227
NTP477M2.5TRV(7)F	470		0.10	7	5300
NTP477M2.5TRV(6)F	470		0.10	6	4546
NTP687M2.5TRD(25)F	680		0.10	25	2449
NTP687M2.5TRD(15)F	680		0.10	15	3162
NTP108M2.5TRD(25)F	1000		0.10	25	2449
NTP108M2.5TRD(15)F	1000		0.10	15	3162
NTP226M4TRB(150)F	22		4.0	0.08	150
NTP336M4TRA(180)F	33	0.06		180	645
NTP336M4TRA(70)F	33	0.08		70	1300
NTP476M4TRA(180)F	47	0.06		180	645
NTP476M4TRA(80)F	47	0.08		80	1200
NTP476M4TRB2(70)F	47	0.08		70	1035
NTP686M4TRA(180)F	68	0.06		180	645
NTP107M4TRA(100)F	100	0.06		100	866
NTP107M4TRA(45)F	100	0.08		45	1291
NTP107M4TRA(35)F	100	0.08		35	1464
NTP227M4TRV(45)F	220	0.10		45	1667
NTP227M4TRD(40)F	220	0.10		40	1936
NTP227M4TRD(25)F	220	0.10		25	2449
NTP227M4TRD(15)F	220	0.10		15	3162
NTP227M4TRD(12)F	220	0.10		12	3536
NTP337M4TRC(55)F	330	0.10		55	1414
NTP337M4TRC(45)F	330	0.08		45	1900
NTP337M4TRV(45)F	330	0.10		45	1667
NTP337M4TRV(25)F	330	0.10		25	2236
NTP337M4TRV(12)F	330	0.10		12	3227
NTP337M4TRD(40)F	330	0.10		40	1936
NTP337M4TRD(25)F	330	0.10		25	2449
NTP337M4TRD(15)F	330	0.10		15	3162



MAX. ESR (mΩ) @ 20°C/100KHz AND RIPPLE CURRENT (mArms) @20°C/100KHz

NIC Part Number	Capacitance Value (μF)	Working Voltage (Vdc)	Dissipation Factor @ +20°C/120Hz	ESR (mΩ) @ +20°C/100KHz	Ripple Current Rating (mA) @ +20°C/100KHz
NTP477M4TRD(25)F	470	4.0	0.10	25	2449
NTP477M4TRD(18)F	470		0.10	18	2887
NTP477M4TRD(15)F	470		0.10	15	3162
NTP477M4TRD(12)F	470		0.10	12	3536
NTP477M4TRD(10)F	470		0.10	10	3873
NTP687M4TRD(25)F	680		0.10	25	2449
NTP687M4TRD(15)F	680		0.10	15	3162
NTP687M4TRD(12)F	680		0.10	12	3536
NTP106M6.3TRA(200)F	10		6.3	0.06	200
NTP156M6.3TRA(180)F	15	0.06		180	645
NTP226M6.3TRA(180)F	22	0.06		180	645
NTP226M6.3TRB2(70)F	22	0.08		70	1035
NTP336M6.3TRA(180)F	33	0.06		180	645
NTP336M6.3TRA(120)F	33	0.08		120	1000
NTP336M6.3TRB2(70)F	33	0.08		70	1035
NTP336M6.3TRB(150)F	33	0.08		150	753
NTP336M6.3TRB(70)F	33	0.08		70	1300
NTP336M6.3TRB(40)F	33	0.08		40	1800
NTP476M6.3TRA(180)F	47	0.06		180	645
NTP476M6.3TRA(150)F	47	0.06		150	707
NTP476M6.3TRA(70)F	47	0.06		70	1035
NTP476M6.3TRB2(70)F	47	0.08		70	1035
NTP476M6.3TRB2(55)F	47	0.08		55	1168
NTP476M6.3TRB(150)F	47	0.08		150	753
NTP476M6.3TRB(70)F	47	0.08		70	1102
NTP686M6.3TRB2(70)F	68	0.08		70	1035
NTP686M6.3TRB(70)F	68	0.08		70	1102
NTP686M6.3TRB(55)F	68	0.08		55	1243
NTP686M6.3TRB(40)F	68	0.08		40	1800
NTP686M6.3TRC(100)F	68	0.09		100	1049
NTP107M6.3TRA(70)F	100	0.08		70	1035
NTP107M6.3TRA(45)F	100	0.08		45	1035
NTP107M6.3TRA(35)F	100	0.08		35	1500
NTP107M6.3TRA(25)F	100	0.08		25	1732
NTP107M6.3TRB2(45)F	100	0.08		45	1291
NTP107M6.3TRB2(35)F	100	0.08		35	1464
NTP107M6.3TRB(70)F	100	0.08		70	1102
NTP107M6.3TRB(45)F	100	0.08		45	1374
NTP107M6.3TRB(35)F	100	0.08		35	1558
NTP107M6.3TRB(25)F	100	0.08		25	1844
NTP107M6.3TRC(100)F	100	0.09		100	1049
NTP107M6.3TRC(55)F	100	0.09		55	1414
NTP107M6.3TRC(45)F	100	0.08		45	1900
NTP107M6.3TRV(15)F	100	0.10		15	2886
NTP157M6.3TRB2(35)F	150	0.10		35	1464
NTP157M6.3TRB(45)F	150	0.08		45	1374
NTP157M6.3TRB(35)F	150	0.08		35	1558
NTP157M6.3TRB(25)F	150	0.08		25	1844
NTP157M6.3TRC(100)F	150	0.09		100	1049
NTP157M6.3TRC(55)F	150	0.09		55	1414
NTP157M6.3TRC(45)F	150	0.09		45	1563
NTP157M6.3TRC(25)F	150	0.09		25	2098
NTP157M6.3TRV(45)F	150	0.10		45	1667
NTP157M6.3TRV(25)F	150	0.10	25	2236	
NTP157M6.3TRV(18)F	150	0.10	18	2635	
NTP157M6.3TRV(15)F	150	0.10	15	2886	
NTP157M6.3TRV(12)F	150	0.10	12	3227	
NTP157M6.3TRD(55)F	150	0.10	55	1651	
NTP157M6.3TRD(40)F	150	0.10	40	1936	
NTP157M6.3TRD(25)F	150	0.10	25	2449	



MAX. ESR (mΩ) @ 20°C/100KHz AND RIPPLE CURRENT (mArms) @20°C/100KHz

NIC Part Number	Capacitance Value (μF)	Working Voltage (Vdc)	Dissipation Factor @ +20°C/120Hz	ESR (mΩ) @ +20°C/100KHz	Ripple Current Rating (mA) @ +20°C/100KHz
NTP227M6.3TRB(35)F	220	6.3	0.08	35	1558
NTP227M6.3TRB(25)F	220		0.08	25	1844
NTP227M6.3TRV(45)F	220		0.10	45	1667
NTP227M6.3TRV(25)F	220		0.10	25	2236
NTP227M6.3TRV(15)F	220		0.10	15	2887
NTP227M6.3TRV(12)F	220		0.10	12	3227
NTP227M6.3TRD(55)F	220		0.10	55	1651
NTP227M6.3TRD(40)F	220		0.10	40	1936
NTP337M6.3TRB(45)F	330		0.10	45	1374
NTP337M6.3TRV(45)F	330		0.10	45	1667
NTP337M6.3TRV(25)F	330		0.10	25	2236
NTP337M6.3TRD(40)F	330		0.10	40	1936
NTP337M6.3TRD(25)F	330		0.10	25	2449
NTP337M6.3TRD(18)F	330		0.10	18	2887
NTP335M10TRA(300)F	3.3		10	0.06	300
NTP475M10TRA(300)F	4.7	0.06		300	500
NTP685M10TRA(300)F	6.8	0.06		300	500
NTP106M10TRA(200)F	10	0.06		200	612
NTP106M10TRA(80)F	10	0.08		80	1200
NTP106M10TRB(200)F	10	0.08		200	652
NTP156M10TRA(180)F	15	0.06		180	645
NTP156M10TRA(80)F	15	0.08		80	1200
NTP226M10TRA(180)F	22	0.06		180	645
NTP226M10TRB2(70)F	22	0.08		70	1035
NTP226M10TRB(150)F	22	0.08		150	753
NTP336M10TRA(200)F	33	0.06		200	612
NTP336M10TRA(70)F	33	0.08		70	1200
NTP336M10TRB2(70)F	33	0.08		70	1035
NTP336M10TRB(150)F	33	0.08		150	753
NTP476M10TRB2(70)F	47	0.08		70	1035
NTP476M10TRB2(45)F	47	0.08		45	1291
NTP476M10TRB(70)F	47	0.08		70	1102
NTP476M10TRB(35)F	47	0.08		35	1558
NTP476M10TRC(100)F	47	0.09		100	1049
NTP686M10TRC(100)F	68	0.09		100	1049
NTP686M10TRC(55)F	68	0.09		55	1414
NTP686M10TRC(45)F	68	0.08		45	1900
NTP686M10TRV(60)F	68	0.10		60	1443
NTP686M10TRD(100)F	68	0.10		100	1225
NTP107M10TRB(70)F	100	0.10		70	1102
NTP107M10TRB(45)F	100	0.10		45	1374
NTP107M10TRC(100)F	100	0.09		100	1049
NTP107M10TRC(55)F	100	0.09		55	1414
NTP107M10TRC(45)F	100	0.08		45	1900
NTP107M10TRC(25)F	100	0.08		25	2600
NTP107M10TRD(55)F	100	0.10		55	1651
NTP107M10TRV(45)F	100	0.10		45	1667
NTP107M10TRV(25)F	100	0.10		25	2236
NTP157M10TRC(55)F	150	0.09		55	1414
NTP157M10TRV(40)F	150	0.10		40	1768
NTP157M10TRV(45)F	150	0.10		45	1667
NTP157M10TRD(55)F	150	0.10		55	1651
NTP157M10TRD(40)F	150	0.10		40	1936
NTP227M10TRD(55)F	220	0.10		55	1651
NTP227M10TRD(40)F	220	0.10		40	1936
NTP227M10TRD(25)F	220	0.10		25	2449

MAX. ESR (mΩ) @ 20°C/100KHz AND RIPPLE CURRENT (mArms) @20°C/100KHz

NIC Part Number	Capacitance Value (μF)	Working Voltage (Vdc)	Dissipation Factor @ +20°C/120Hz	ESR (mΩ) @ +20°C/100KHz	Ripple Current Rating (mA) @ +20°C/100KHz
NTP335M16TRA(800)F	3.3	16	0.06	800	306
NTP475M16TRB(200)F	4.7		0.08	200	652
NTP685M16TRB(200)F	6.8		0.08	200	652
NTP106M16TRB(100)F	10		0.08	100	922
NTP336M16TRV(70)F	33		0.10	70	1336
NTP476M16TRV(70)F	47		0.10	70	1336
NTP476M16TRV(45)F	47		0.01	45	2000
NTP476M16TRD(70)F	47		0.10	70	1464
NTP686M16TRV(50)F	68		0.10	50	1581
NTP686M16TRD(55)F	68		0.10	55	1651
NTP686M16TRD(50)F	68		0.10	50	2100
NTP226M20TRV(90)F	22		20	0.10	90
NTP685M25TRB(100)F	6.8	25	0.08	100	922
NTP156M25TRV(90)F	15		0.10	90	1179

RIPPLE CURRENT TEMPERATURE DERATING

20°C	85°C	105°C
1.0	0.9	0.6

CASE DIMENSIONS (mm)

Case Size	EIA Code	L	H	W ₁	W ₂	T
A	3216	3.2 ± 0.2	1.6 ± 0.2	1.6 ± 0.2	1.2 ± 0.1	0.8 ± 0.3
B2	3528L	3.5 ± 0.2	1.1 ± 0.1	2.8 ± 0.2	2.2 ± 0.1	0.8 ± 0.3
B	3528	3.5 ± 0.2	1.9 ± 0.2	2.8 ± 0.2	2.2 ± 0.1	0.8 ± 0.3
C	6032	6.0 ± 0.3	2.5 ± 0.3	3.2 ± 0.3	2.2 ± 0.1	1.3 ± 0.3
V	7343	7.3 ± 0.3	1.9 ± 0.1	4.3 ± 0.3	2.4 ± 0.1	1.3 ± 0.3
D	7343	7.3 ± 0.3	2.8 ± 0.3	4.3 ± 0.3	2.4 ± 0.1	1.3 ± 0.3

"A" Case Size

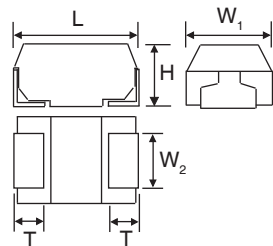

"B2, B" Case Size

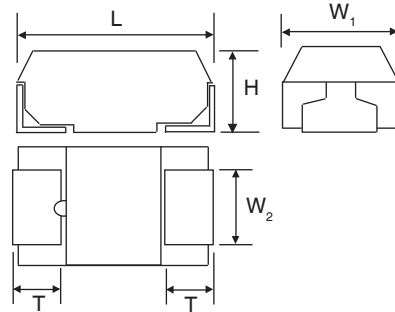

"C, V, D" Case Size

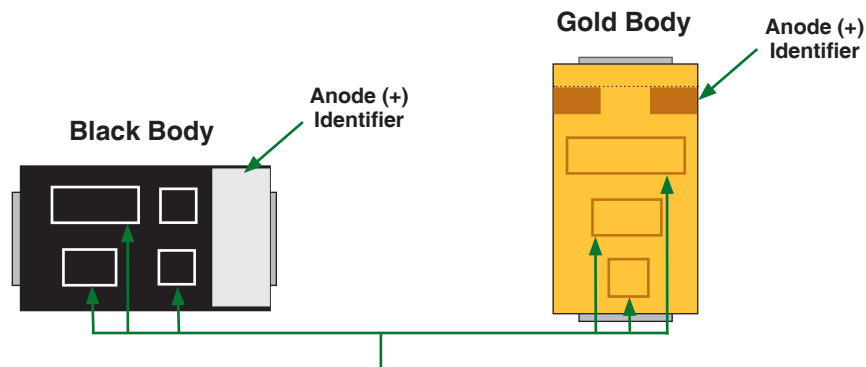
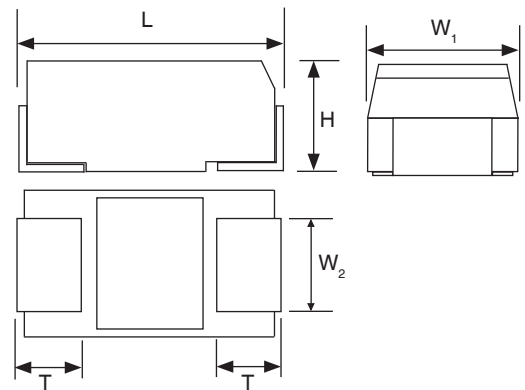

Value Marking/Production Code
(Format varies, see marking guide)



COMPONENT MARKING

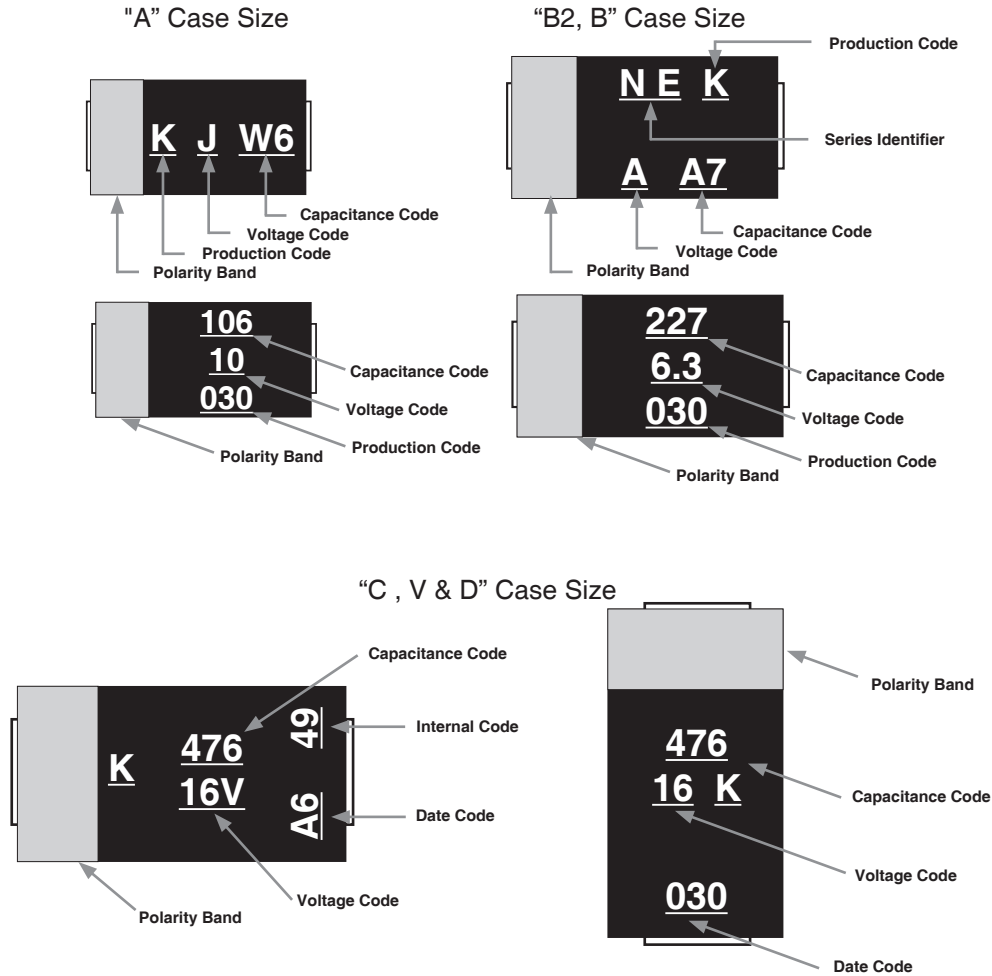

Voltage Codes	
2.5V	e
4.0V	g
6.3V	J
10V	A
16V	C
20V	D
25V	E

Date Code		
Year	Month	
A = 2010	1 = Jan	7 = Jul
B = 2011	2 = Feb	8 = Aug
C = 2012	3 = Mar	9 = Sep
D = 2013	4 = Apr	O = Oct
E = 2014	5 = May	N = Nov
F = 2015	6 = Jun	D = Dec

Date Code		
Example	Year	Week#
030	0 = 2010	30
105	1 = 2011	5
332	3 = 2013	32
448	4 = 2014	48

TAPE SPECIFICATIONS (mm)

Case Size	A ±0.2	B ±0.2	D ±0.1	E ±0.1	F ±0.1	P ₀ ±0.05	P ₁ ±0.1	P ₂ ±0.1	K ±0.2	t max.	W ±0.3	Reel Qty	
												180mm Reel (Std.)	330mm Reel (Opt.)
A	1.9	3.5	φ1.5	1.75	3.5	2.0	4.0	4.0	1.9	0.2	8.0	2000	9,000
B2	3.2	3.8										3000	10,000
B	3.3											2000	5,000
C	3.7	6.4			500					2,500			
V	4.8	7.7			1000					3,000			
D	4.8	7.7	500	2,500									

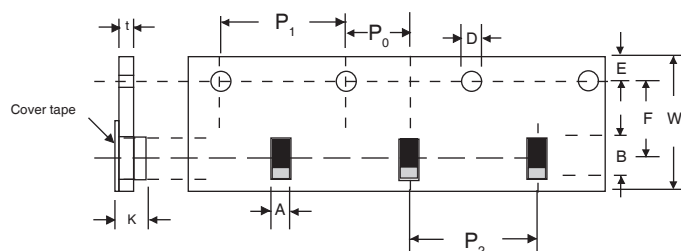

REEL SPECIFICATIONS (mm)

Tape Width	A ± 2.0	B min.	C ± 0.5	D ± 0.5	E ± 0.5	W ₁ ± 1.0	W ₂ max.
8mm	φ180	φ50	φ13	φ21	2.0	10	14.5
12mm						14.5	18.5
8mm	φ330	φ80				10	14.5
12mm						14.5	18.5

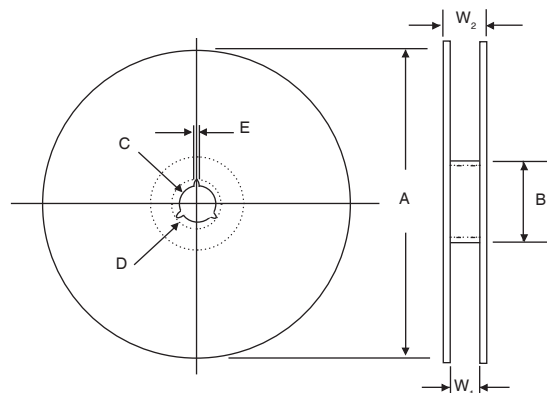

RECOMMENDED LAND PATTERN (mm)

Case Size	S max.	X min.	Y min.
A2	1.1	3.8	1.5
A	1.1	3.8	1.5
B2, B	1.4	4.1	2.7
C	2.9	6.9	2.7
D	4.1	8.2	2.9

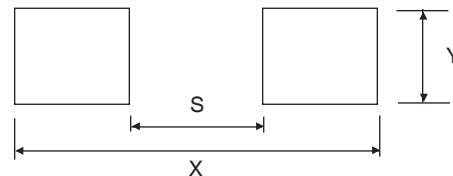

RECOMMENDED PEAK TEMPERATURE/TIME

Maximum Time	Peak Soldering Temperature
5 Seconds	260°C*
10 Seconds	240°C
20 Seconds	230°C

*Notes regarding peak reflow temperature:

1. NTP parts are moisture sensitive (MSL 3) and are shipped in moisture control bags. After opening the bag capacitors should be stored at +30°C, relative humidity of 60% maximum and soldered within 168 hours.

2. The parts should be soldered using the minimum amount of heat required.

3. If the time after opening the bag exceeds 168 hours components should be baked using the following conditions:

Temperature.....50°C
Time.....96 hours

4. If the above storage or baking conditions are not followed the peak soldering temperature should be limited to +240°C.

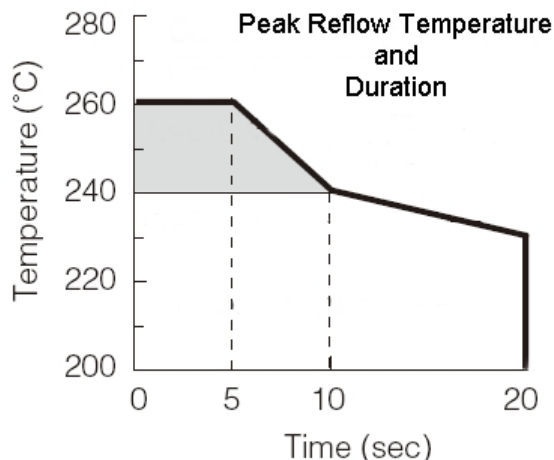

PRECAUTIONS

Please review the notes on correct use, safety and precautions found on our website at www.niccomp.com/tantpc
If in doubt or uncertainty, please review your specific application - process details with NIC's technical support personnel: tpmg@niccomp.com

