



SGM8477-1/SGM8477-3 1.8V to 5.5V, Low Noise, Zero-Drift Difference Amplifiers

GENERAL DESCRIPTION

The SGM8477-1/3 are low noise, high precision CMOS difference amplifiers, which are designed to support precision differential signal processing. These devices can operate from 1.8V to 5.5V single supply, while consuming only 380 μ A quiescent current. The supply current of SGM8477-3 is less than 0.5 μ A in shutdown status, when external MCU control EN pin to logical "low".

The SGM8477-1/3 feature low noise, a 10 μ V maximum input offset voltage and zero-drift over time and temperature. These devices are suitable in low voltage and low power systems. They support rail-to-rail input and output operation. Meanwhile, the SGM8477-1/3 fit in tiny packages. They are designed to provide high performance for sensing high-side and low-side current accurately, such as single battery voltage.

The SGM8477-1/3 save external components by integrated matched resistors in differential applications. They have different versions for gains of 50 and 300.

The SGM8477-1 is available in Green SC70-6 and UTQFN-1.8 \times 1.4-10L packages. The SGM8477-3 is available in a Green UTQFN-1.8 \times 1.4-10L package. They are all specified over -40 $^{\circ}$ C to +125 $^{\circ}$ C temperature range.

FEATURES

- **Low Input Offset Voltage: 10 μ V (MAX)**
- **Low Drift: 0.02 μ V/ $^{\circ}$ C (TYP)**
- **Low 0.1Hz to 10Hz Noise: 250nV_{P-P}**
- **Low Noise: 10nV/ $\sqrt{\text{Hz}}$ at 1kHz**
- **Integrated RFI Filter**
- **Rail-to-Rail Input and Output**
- **Single-Supply Operation**
- **Supply Voltage Range: 1.8V to 5.5V**
- **Quiescent Current: 380 μ A (TYP)**
- **Shutdown Status Current: < 0.5 μ A**
- **-40 $^{\circ}$ C to +125 $^{\circ}$ C Operating Temperature Range**
- **Small Packaging:**
 - SGM8477-1 is Available in Green SC70-6 and UTQFN-1.8 \times 1.4-10L Packages**
 - SGM8477-3 is Available in a Green UTQFN-1.8 \times 1.4-10L Package**

APPLICATIONS

Temperature Measurements
Medical Instrumentation
Transducer Applications
Electronic Scales
Handheld Test Equipment
Battery-Powered Instruments

PACKAGE/ORDERING INFORMATION

MODEL	PACKAGE DESCRIPTION	SPECIFIED TEMPERATURE RANGE	ORDERING NUMBER	PACKAGE MARKING	PACKING OPTION
SGM8477-1B (Gain = 50)	SC70-6	-40°C to +125°C	SGM8477-1BXC6G/TR	G10XX	Tape and Reel, 3000
	UTQFN-1.8×1.4-10L	-40°C to +125°C	SGM8477-1BXUWQ10G/TR	I6XX	Tape and Reel, 3000
SGM8477-1G (Gain = 300)	SC70-6	-40°C to +125°C	SGM8477-1GXC6G/TR	GHFXX	Tape and Reel, 3000
	UTQFN-1.8×1.4-10L	-40°C to +125°C	SGM8477-1GXUWQ10G/TR	I4XX	Tape and Reel, 3000
SGM8477-3B (Gain = 50)	UTQFN-1.8×1.4-10L	-40°C to +125°C	SGM8477-3BXUWQ10G/TR	I7XX	Tape and Reel, 3000
SGM8477-3G (Gain = 300)	UTQFN-1.8×1.4-10L	-40°C to +125°C	SGM8477-3GXUWQ10G/TR	I5XX	Tape and Reel, 3000

MARKING INFORMATION

NOTE: XX = Date Code.

SC70-6

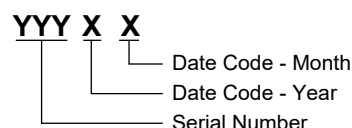

UTQFN-1.8×1.4-10L

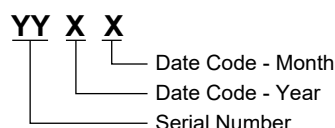

Green (RoHS & HSF): SG Micro Corp defines "Green" to mean Pb-Free (RoHS compatible) and free of halogen substances. If you have additional comments or questions, please contact your SGMICRO representative directly.

ABSOLUTE MAXIMUM RATINGS

Supply Voltage.....	6V
Input Common Mode Voltage Range	
.....	(-V _S) - 0.3V to (+V _S) + 0.3V
Junction Temperature.....	+150°C
Storage Temperature Range	-65°C to +150°C
Lead Temperature (Soldering 10sec)	+260°C
ESD Susceptibility	
HBM.....	4000V
MM.....	400V
CDM	1000V

RECOMMENDED OPERATING CONDITIONS

Specified Voltage Range	1.8V to 5.5V
Operating Temperature Range	-40°C to +125°C

OVERSTRESS CAUTION

Stresses beyond those listed in Absolute Maximum Ratings may cause permanent damage to the device. Exposure to absolute maximum rating conditions for extended periods

may affect reliability. Functional operation of the device at any conditions beyond those indicated in the Recommended Operating Conditions section is not implied.

ESD SENSITIVITY CAUTION

This integrated circuit can be damaged if ESD protections are not considered carefully. SGMICRO recommends that all integrated circuits be handled with appropriate precautions. Failure to observe proper handling and installation procedures can cause damage. ESD damage can range from subtle performance degradation to complete device failure. Precision integrated circuits may be more susceptible to damage because even small parametric changes could cause the device not to meet the published specifications.

DISCLAIMER

SG Micro Corp reserves the right to make any change in circuit design, or specifications without prior notice.

PIN CONFIGURATIONS

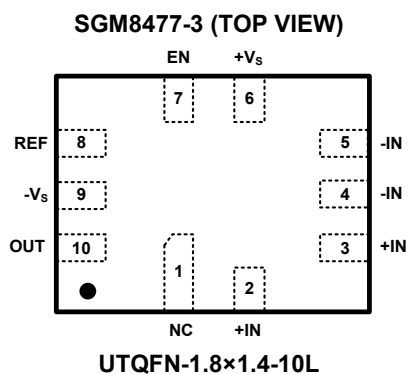
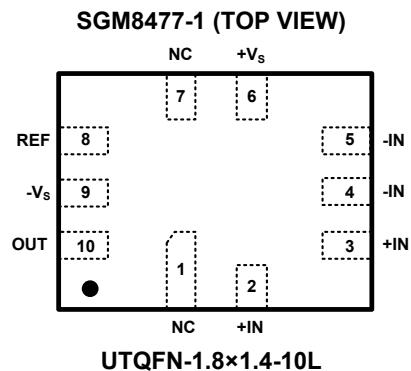
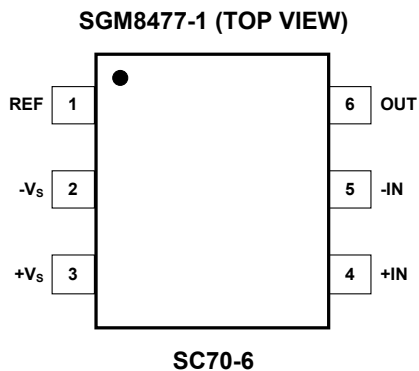

ELECTRICAL CHARACTERISTICS

(At $T_A = +25^\circ\text{C}$, $+V_S = 1.8\text{V}$ to 5.5V , $-V_S = 0\text{V}$, $V_{CM} = +V_S/2$, $V_{REF} = +V_S/2$ and $R_L = 10\text{k}\Omega$, unless otherwise noted.)

PARAMETER	CONDITIONS	MIN	TYP	MAX	UNITS
Input Characteristics					
Input Offset Voltage (V_{OS})	$+V_S = 5\text{V}$		3	10	μV
	$-40^\circ\text{C} \leq T_A \leq +125^\circ\text{C}$			12	
Input Offset Voltage Drift ($\Delta V_{OS}/\Delta T$)	$-40^\circ\text{C} \leq T_A \leq +125^\circ\text{C}$		0.02		$\mu\text{V}/^\circ\text{C}$
Input Common Mode Voltage Range (V_{CM})		$-V_S$		$+V_S$	V
Common Mode Rejection Ratio (CMRR)	$(-V_S) < V_{CM} < (+V_S)$	89	108		dB
	$-40^\circ\text{C} \leq T_A \leq +85^\circ\text{C}$	84			
	$-40^\circ\text{C} \leq T_A \leq +125^\circ\text{C}$	58			
Output Characteristics					
Output Voltage Swing from Rail	$R_L = 10\text{k}\Omega$		6	21	mV
	$-40^\circ\text{C} \leq T_A \leq +125^\circ\text{C}$			23	
Short-Circuit Current (I_{SC})	$+V_S = 1.8\text{V}$		12		mA
	$+V_S = 5\text{V}$		50		
Power Supply					
Specified Voltage Range (V_S)		1.8		5.5	V
Power Supply Rejection Ratio (PSRR)	$+V_S = 1.8\text{V}$ to 5.5V		1	4	$\mu\text{V}/\text{V}$
	$-40^\circ\text{C} \leq T_A \leq +125^\circ\text{C}$			6	
Quiescent Current (I_Q)	$I_O = 0$, $EN = 1.8\text{V}$ (active), $+V_S = 5\text{V}$		380	530	μA
	$I_O = 0$, $EN = 0\text{V}$ (shutdown), $+V_S = 5\text{V}$, SGM8477-3 only		0.2	0.5	
Turn-On Time	$+V_S = 5\text{V}$		100		μs
Dynamic Performance					
-3dB Bandwidth (BW_{-3})	$C_L = 50\text{pF}$, Gain = +50		150		kHz
	$C_L = 50\text{pF}$, Gain = +300		32		kHz
Slew Rate (SR)	$+V_S = 5\text{V}$, Gain = +50		0.4		V/ μs
	$+V_S = 5\text{V}$, Gain = +300		0.15		
Noise					
Input Voltage Noise	$f = 0.1\text{Hz}$ to 10Hz		250		nV _{P-P}
Input Voltage Noise Density (e_n)	$f = 1\text{kHz}$		10		nV/ $\sqrt{\text{Hz}}$
Enable Control (SGM8477-3 Only)					
Input Logic High Voltage (V_{IH})		$(-V_S) + 1.8$			V
Input Logic Low Voltage (V_{IL})				$(-V_S) + 0.4$	V
EN Input Bias Current	$V_{EN} = +V_S$ or $V_{EN} = -V_S$	-0.4		0.4	μA
Gain					
Gain Error	$(-V_S) + 0.1\text{V} \leq V_{OUT} \leq (+V_S) - 0.1\text{V}$, Gain = +50		0.01	0.2	%
	$(-V_S) + 0.1\text{V} \leq V_{OUT} \leq (+V_S) - 0.1\text{V}$, Gain = +300		0.01	0.3	%
Gain Temperature Coefficient	$(-V_S) + 0.1\text{V} \leq V_{OUT} \leq (+V_S) - 0.1\text{V}$, Gain = +50		2		ppm/ $^\circ\text{C}$
	$(-V_S) + 0.1\text{V} \leq V_{OUT} \leq (+V_S) - 0.1\text{V}$, Gain = +300		7		ppm/ $^\circ\text{C}$

TYPICAL PERFORMANCE CHARACTERISTICS

+V_S = 5V, T_A = +25°C, unless otherwise noted.

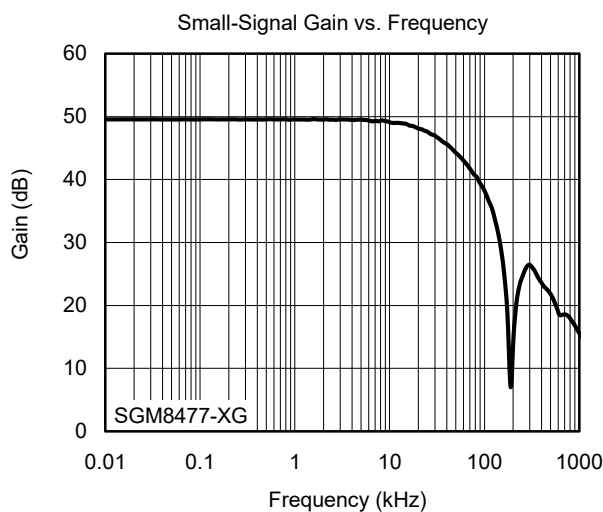
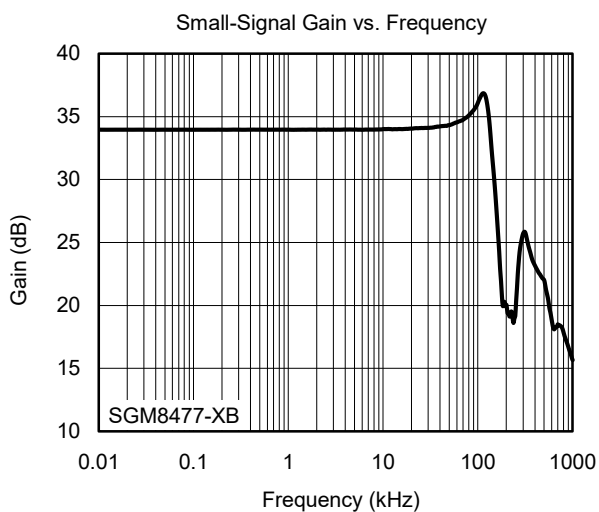
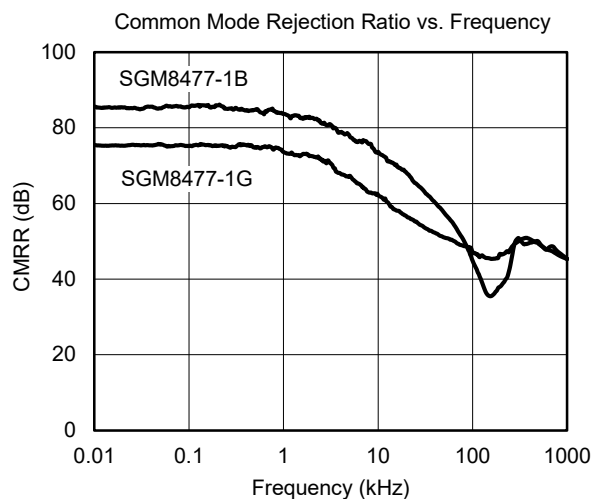
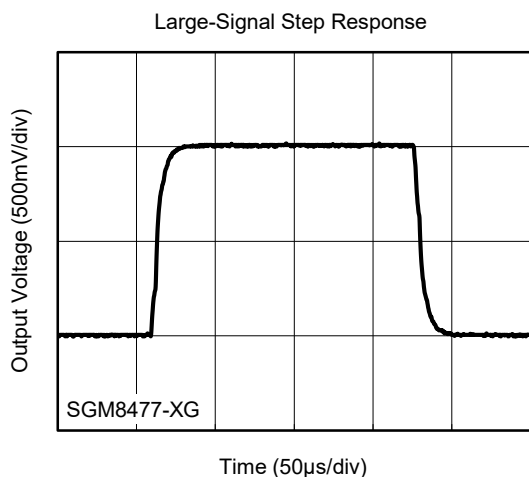
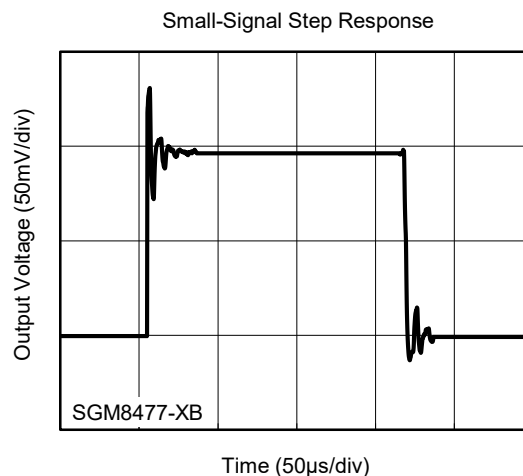
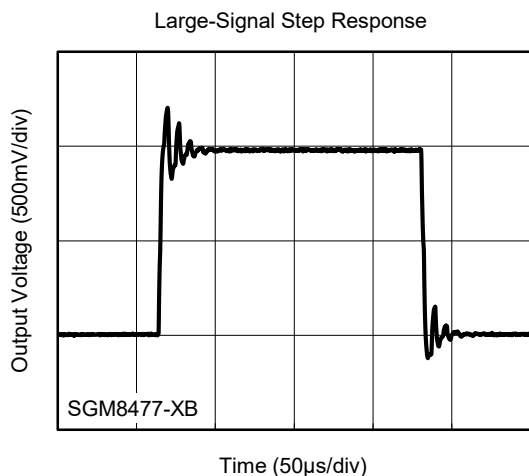

TYPICAL PERFORMANCE CHARACTERISTICS (continued)

+V_S = 5V, T_A = +25°C, unless otherwise noted.

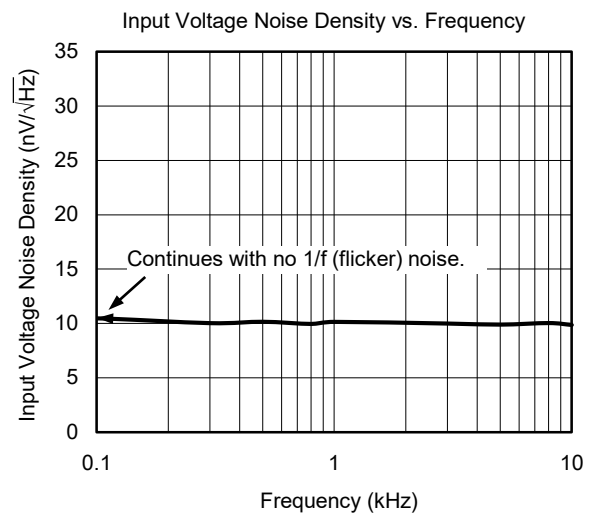
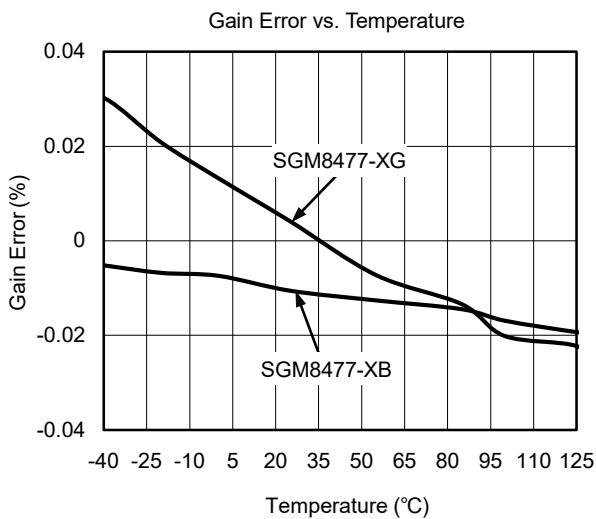
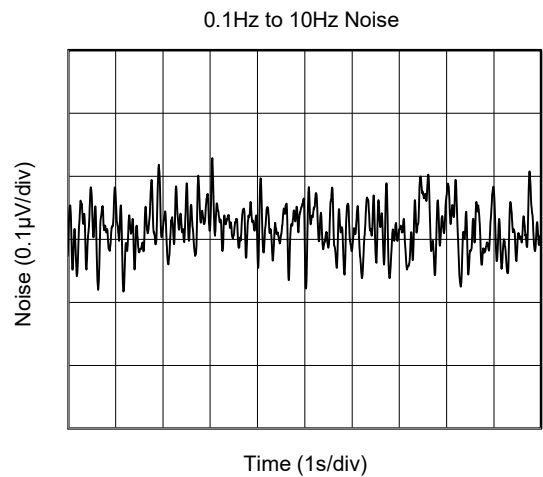
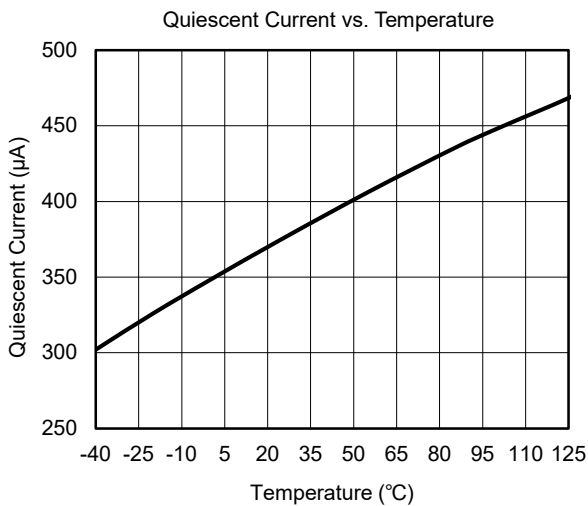
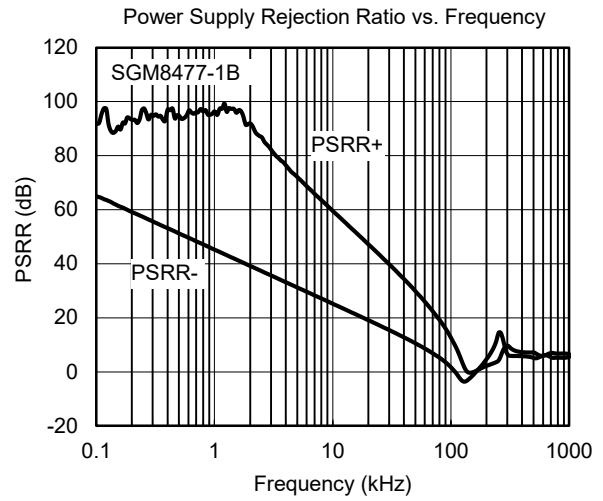
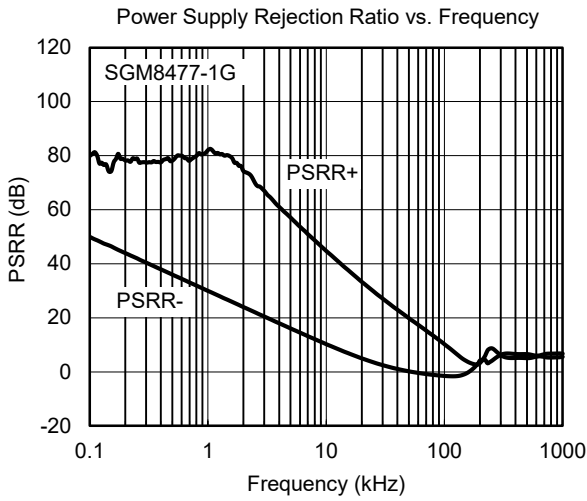

TYPICAL PERFORMANCE CHARACTERISTICS (continued)

+V_S = 5V, T_A = +25°C, unless otherwise noted.

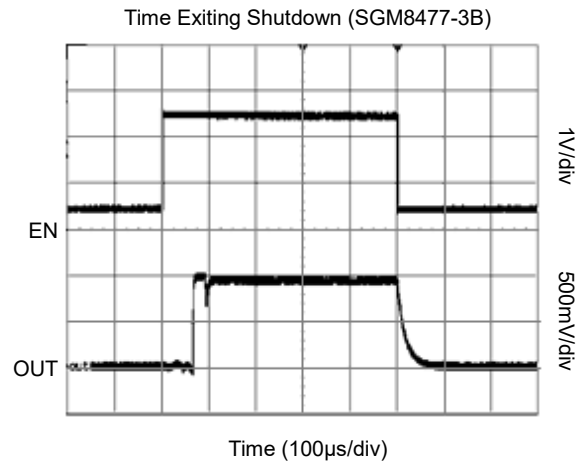
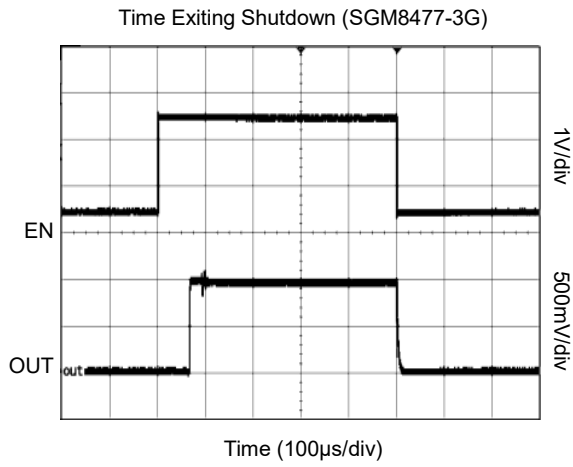

REVISION HISTORY

NOTE: Page numbers for previous revisions may differ from page numbers in the current version.

Changes from Original (MAY 2017) to REV.A	Page
Changed from product preview to production data.....	All

PACKAGE OUTLINE DIMENSIONS

SC70-6

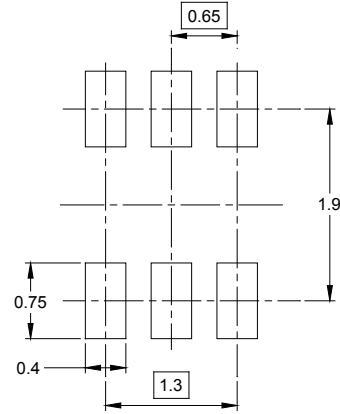
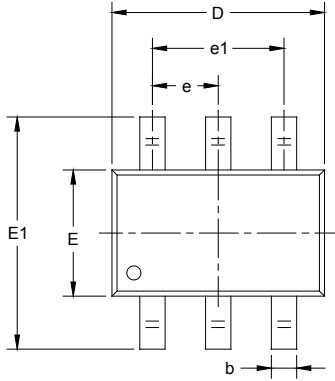

RECOMMENDED LAND PATTERN (Unit: mm)

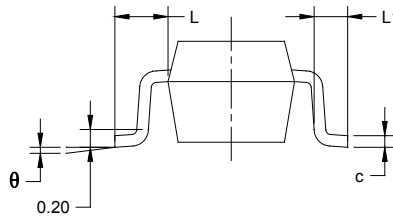
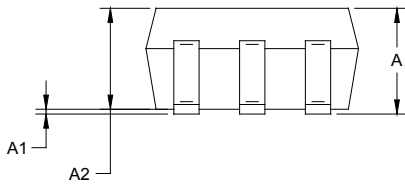

Symbol	Dimensions In Millimeters		Dimensions In Inches	
	MIN	MAX	MIN	MAX
A	0.900	1.100	0.035	0.043
A1	0.000	0.100	0.000	0.004
A2	0.900	1.000	0.035	0.039
b	0.150	0.350	0.006	0.014
c	0.080	0.150	0.003	0.006
D	2.000	2.200	0.079	0.087
E	1.150	1.350	0.045	0.053
E1	2.150	2.450	0.085	0.096
e	0.65 TYP		0.026 TYP	
e1	1.300 BSC		0.051 BSC	
L	0.525 REF		0.021 REF	
L1	0.260	0.460	0.010	0.018
θ	0°	8°	0°	8°

PACKAGE OUTLINE DIMENSIONS

UTQFN-1.8×1.4-10L

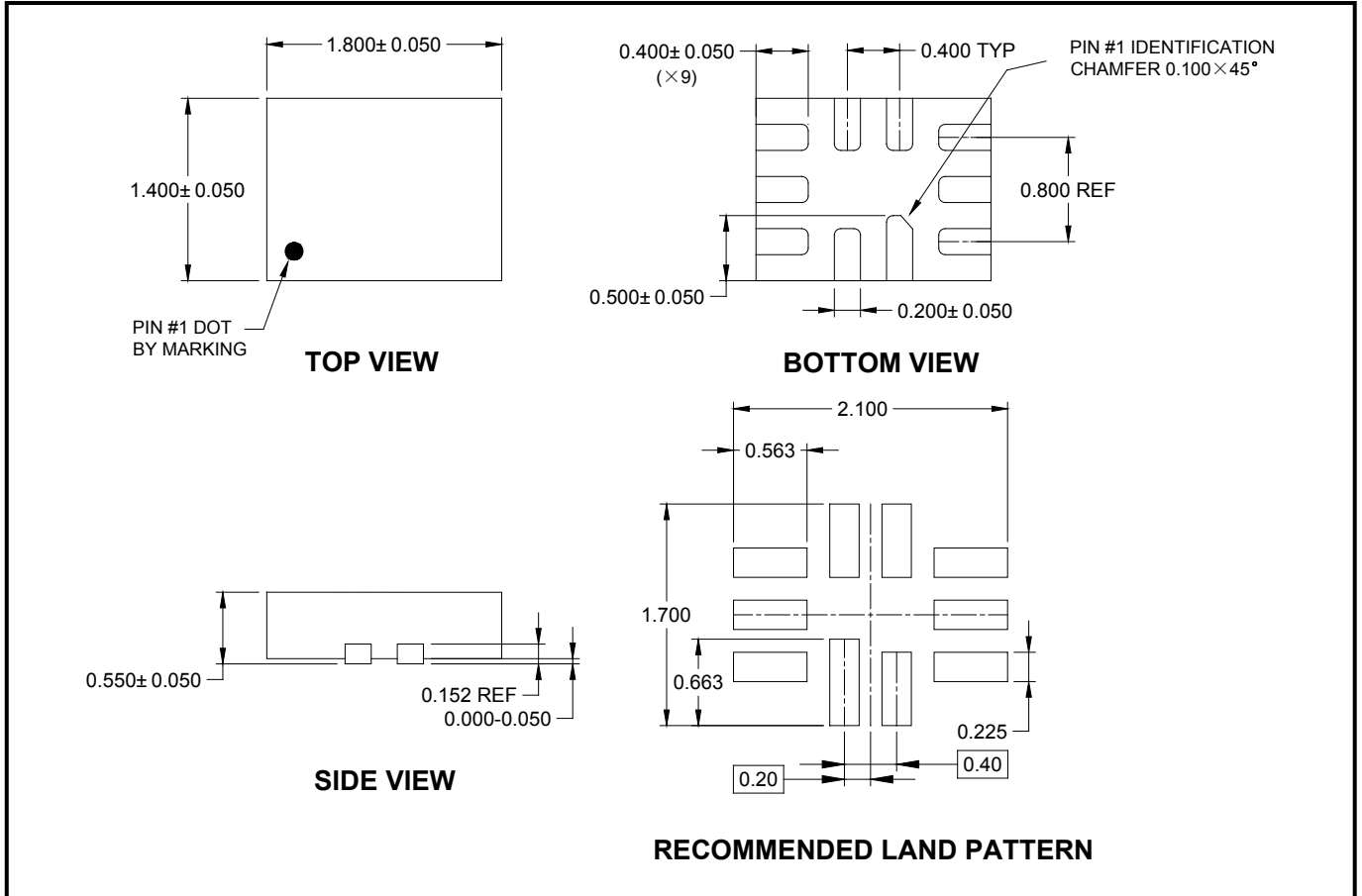

NOTE: All linear dimensions are in millimeters.

TAPE AND REEL INFORMATION

REEL DIMENSIONS



TAPE DIMENSIONS



NOTE: The picture is only for reference. Please make the object as the standard.

KEY PARAMETER LIST OF TAPE AND REEL

Package Type	Reel Diameter	Reel Width W1 (mm)	A0 (mm)	B0 (mm)	K0 (mm)	P0 (mm)	P1 (mm)	P2 (mm)	W (mm)	Pin1 Quadrant
SC70-6	7"	9.5	2.40	2.50	1.20	4.0	4.0	2.0	8.0	Q3
UTQFN-1.8×1.4-10L	7"	9.0	1.75	2.10	0.70	4.0	4.0	2.0	8.0	Q1

DD0001

PACKAGE INFORMATION

CARTON BOX DIMENSIONS



NOTE: The picture is only for reference. Please make the object as the standard.

KEY PARAMETER LIST OF CARTON BOX

Reel Type	Length (mm)	Width (mm)	Height (mm)	Pizza/Carton
7" (Option)	368	227	224	8
7"	442	410	224	18

DD0002