

1A Standalone Linear Li-Ion Battery Charge

DESCRIPTION

The BL8576 is a single cell, fully integrated constant current (CC)/constant voltage (CV) Li-ion battery charger. Its compact package with minimum external components requirement makes the BL8576 ideal for portable applications.

No external sense resistor or blocking diode is necessary for the BL8576. Build-in thermal feedback mechanism regulates the charge current to control the die temperature during high power operation or at elevated ambient temperature.

The BL8576 has a pre-charge function for trickle charging deeply discharged batteries. The fast charge current can be programmed by an external resistor. CV regulation mode is automatically enabled once the battery's charging curve reaches the constant voltage portion. The output current then decays and is finally terminated once the charge current drops to 1/10 of the programmed value. The BL8576 keeps monitoring the battery voltage and enables a new charge cycle once the voltage drops by 150mV below the CV value.

Power supply state is constantly monitored and the battery drain current is reduced to minimum value automatically when the BL8576 senses a lack of input power. In its shutdown mode, the BL8576 can reduce the supply current to less than 25 μ A. A status pin outputs a logic HIGH/LOW to indicate the charging status and the presence of power supply.

Other features include charge current monitor, under-voltage lockout.

TYPICAL APPLICATION

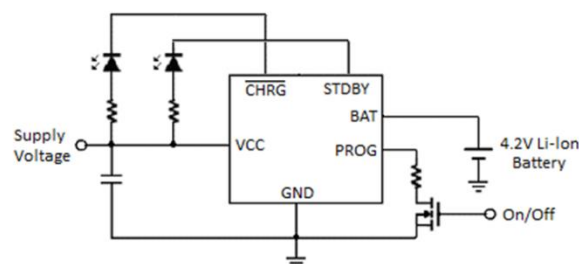

FEATURES

- Standalone Capability with no Requirement of External MOSFET, Sense Resistor or Blocking Diode.
- Complete Linear Charger in Compact Package for Single Cell Lithium-Ion Batteries
- Programmable Pre-charge, Fast Charge and Termination Current.
- Constant-Current/Constant-Voltage Operation with Thermal Regulation to Maximize Charge Rate Without Risk of Overheating
- Charges Single Cell Li-Ion Batteries Directly from USB Port
- Preset 4.2V Charge Voltage with $\pm 1\%$ Accuracy
- Automatic Recharge
- Charge Status Output Pin
- C/10 Charge Termination
- 25 μ A Supply Current in Shutdown
- 2.9V Trickle Charge Threshold
- Soft-Start Limits Inrush Current
- Available in ESOP8 Package

APPLICATIONS

- Cellular Telephones, PDAs, MP3 Players
- Charging Docks and Cradles
- Bluetooth Applications

BL8576

ORDERING INFORMATION

BL8576 ①②③

Code	Description
①	Temperature&RoHS: C: -40~85°C, Pb Free RoHS Std.
②	Package type: S8: ESOP8
③	Packing type: TR: Tape&Reel (Standard)

PIN CONFIGURATION

Product Classification		BL8576CS8TR
B3 LLXYW	B3: Product code	
	LL: Lot No.	
	X: Fab code	
	YW: Date code	

Note: Y: The Year of manufacturing, "1" stands for year 2011, "2" stands for year 2012, and "8" stands for year 2018.

W: The week of manufacturing. "A" stands for week 1, "Z" stands for week 26, "A" stands for week 27, "Z" stands for week 52.

BLOCK DIAGRAM

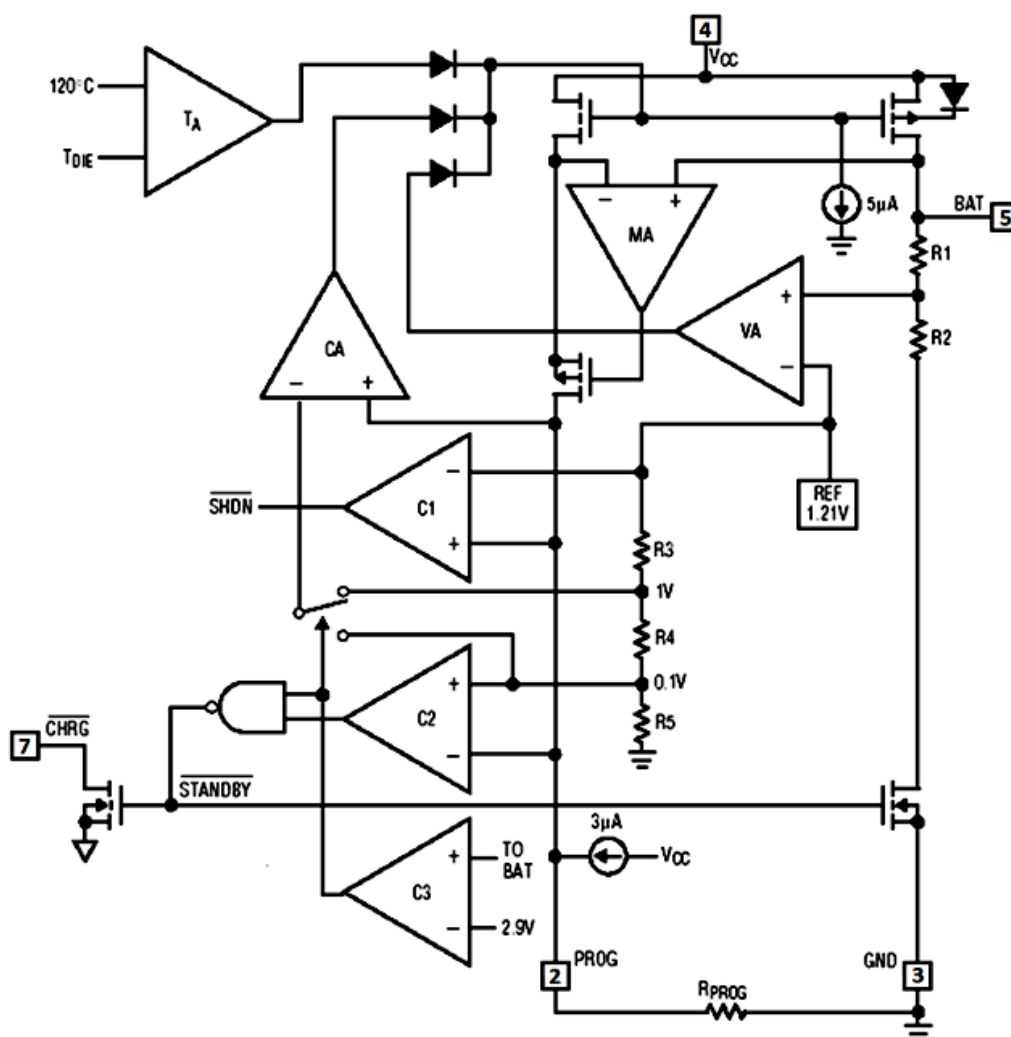

PIN DESCRIPTION

PROG (Pin2): Program, Monitor the charge current and Shutdown. This pin set to 1V in constant-current mode. The charge current is programmed by connecting a 1% resistor, RPROG, to GND pin. The charge current can be calculated using the following formula:

$$I_{BAT} = (V_{PROG} / R_{PROG}) \cdot 1000$$

The PROG pin can also be used to switch the charger to shutdown mode by disconnecting the program resistor from ground. This result in a 3μA current to pull the PROG pin to a high level shutdown threshold voltage, thus stop the charging and reduce the supply current to 25μA. This pin is also clamped to approximately 2.4V. A higher voltage beyond this value will draw currents as high as 1.5mA. Device normal operation can be resumed by reconnecting the RPROG resistor to ground.

GND (Pin3): Ground.

VCC (Pin4): Positive Input Supply. Needs to be bypassed with at least a 1μF capacitor. When input voltage drops to within 80mV of the BAT pin voltage, the BL8576 switches to shutdown mode.

BAT (Pin5): Charge Current Output. This pin provides charge current to the battery and regulates the final float voltage to 4.2V which is set by an internal precision resistor divider.

STDBY (Pin6): Open-Drain Charge Status Output. The STDBY pin outputs low when the battery is full.

CHRG (Pin7): Open-Drain Charge Status Output. The CHRG pin outputs low when the battery is charging. When the BL8576 detects an under voltage lockout condition, CHRG is forced high impedance.

ABSOLUTE MAXIMUM RATING

Parameter	Value
VCC	-0.3V to 6V
PROG	- 0.3V to VCC + 0.3V
BAT	-0.3V to 5V
CHRG	-0.3V to 6V
BAT short-circuit duration	Continuous
PROG pin current	5mA
Maximum junction temperature	125°C
Operating ambient temperature range	-40°C to 85°C
Storage temperature range	-40°C to 125°C
Lead temperature (soldering, 10 sec)	260°C

Note:

Exceed these limits to damage to the device.

Exposure to absolute maximum rating conditions may affect device reliability.

ELECTRICAL CHARACTERISTICS

VCC=5V, TA=25°C, R_{PROG}=10K, unless otherwise noted.

SYMBOL	PARAMETER	CONDITIONS	MIN	TYP	MAX	UNITS
VCC	Input supply voltage		4.25		6.0	V
ICC	Input supply current	Charge mode (note 1)		500	2000	μA
		Standby mode (charge terminated)		50	100	μA
		Shutdown mode (R _{PROG} not connected, VCC<V _{BAT} , or VCC<V _{ULO})		25	50	μA
V _{FLOAT}	Regulated output (float) voltage	I _{BAT} = 40mA	4.158	4.2	4.242	V
I _{BAT}	BAT pin current	R _{PROG} = 2K, current mode	475	500	525	mA
		R _{PROG} = 10K, current mode	85	100	115	mA
		Standby mode, V _{BAT} = 4.2V	0	-2.5	-6	μA
		Shutdown mode (R _{PROG} not connected)			-1	μA
		Sleep mode, VCC = 0V			-1	μA
I _{TRIKL}	Trickle charge current	V _{BAT} < V _{TRIKL} , R _{PROG} = 10K	4		13	mA
V _{TRIKL}	Trickle charge threshold voltage	V _{BAT} rising	2.8	2.9	3	V
V _{TRHYS}	Trickle charge hysteresis voltage		60	100	150	mV
V _{UV}	VCC under voltage lockout threshold	From VCC low to high	2.7	2.9	3.1	V
V _{UVHYS}	VCC under voltage lockout hysteresis		150	200	300	mV
V _{MSD}	Manual shutdown threshold voltage	PROG pin rising	1.15	1.21	1.30	V
		PROG pin falling	0.9	1	1.1	V
V _{ASD}	VCC-V _{BAT} lockout threshold voltage	VCC from low to high	70	130	200	mV
		VCC from high to low	40	90	150	mV
I _{TERM}	1C/10 termination current threshold	Note 2	4	10	13	mA
V _{PROG}	PROG pin voltage	Current mode, V _{BAT} =3.5V	0.93	1	1.07	V
V _{CHRG}	CHRG pin output low voltage	I _{CHRG} = 5mA		0.2	0.6	V
V _{RECHRG}	Recharge BAT threshold voltage	V _{FLOAT} - V _{RECHRG}	60	100	180	mV
T _{LIM}	Junction temperature in constant temperature mode			120		°C
R _{ON}	Power FET "ON" resistance (between VCC and BAT)			1.2		Ω
t _{SS}	Soft-start time	I _{BAT} = 0 to I _{BAT} = 1000V/R _{PROG}		100		μs
t _{RECHARGE}	Recharge comparator filter time	V _{BAT} high to low	0.3	1	3	ms
t _{TERM}	Termination comparator filter time	I _{BAT} falling below 1*I _{CHG} /10	0.3	1	3	ms
I _{PROG}	PROG pin pull-up current			3		μA

Note:

1) Supply current includes PROG pin current (approximately 500μA) but does not include any current delivered to the battery through the BAT pin (approximately 100mA).

2) I_{TERM} is expressed as a fraction of measured full charge current with indicated PROG resistor.

TYPICAL PERFORMANCE CHARACTERISTICS

(VCC=5V, TA=25°C, unless otherwise noted.)

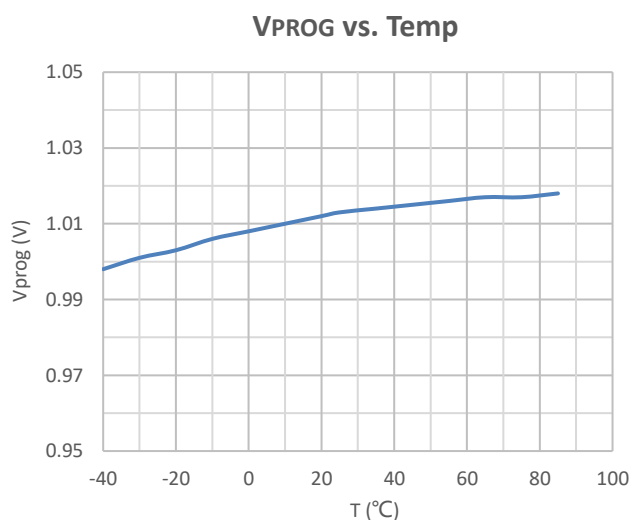
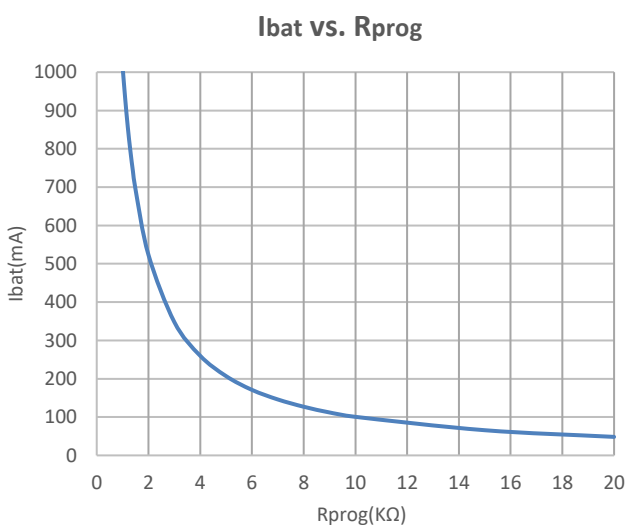
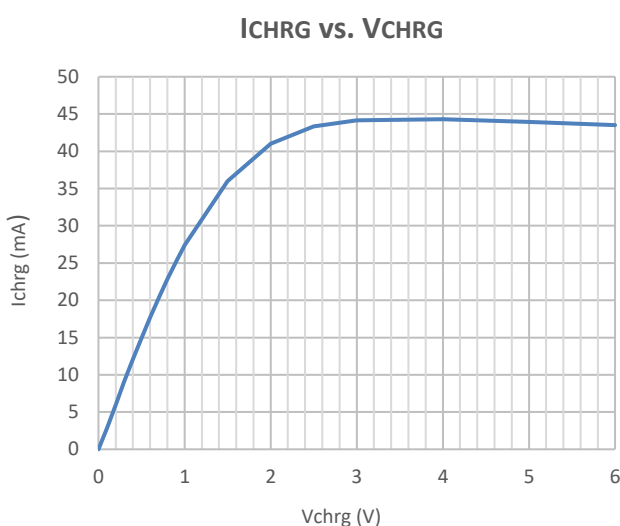
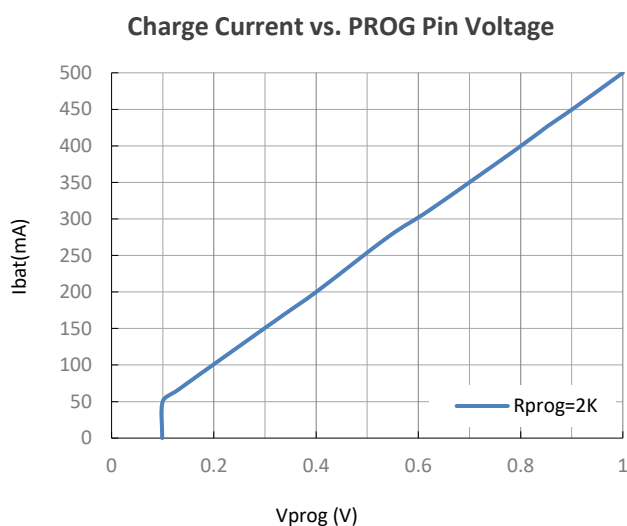
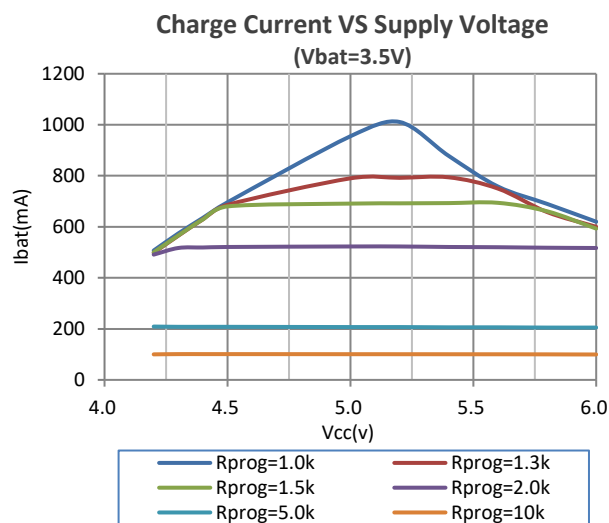
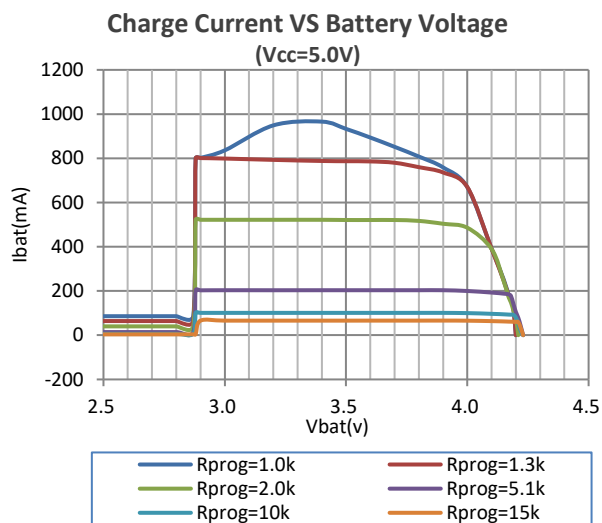

**I_{PROG} vs. V_{PROG}
(Pul-Up Current)**

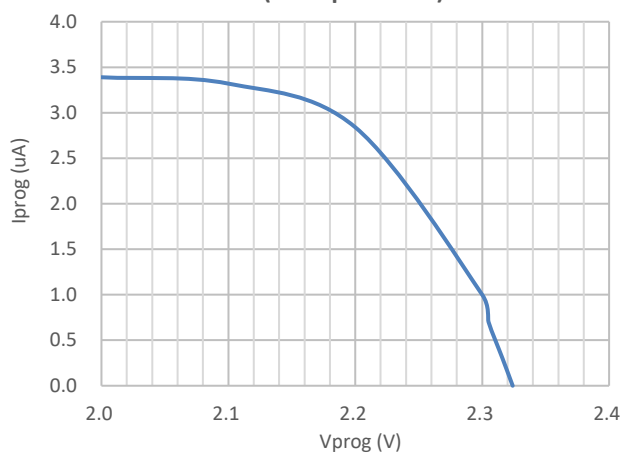

**I_{PROG} vs. V_{PROG}
(Clamp Current)**

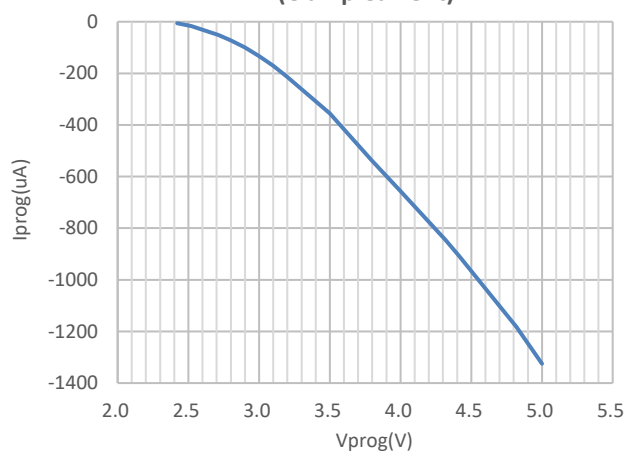

Regulated Voltage vs. Supply Voltage

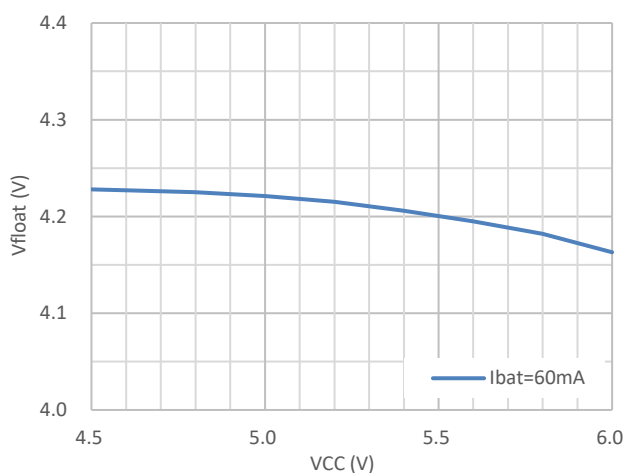

Regulated Voltage vs. Temp

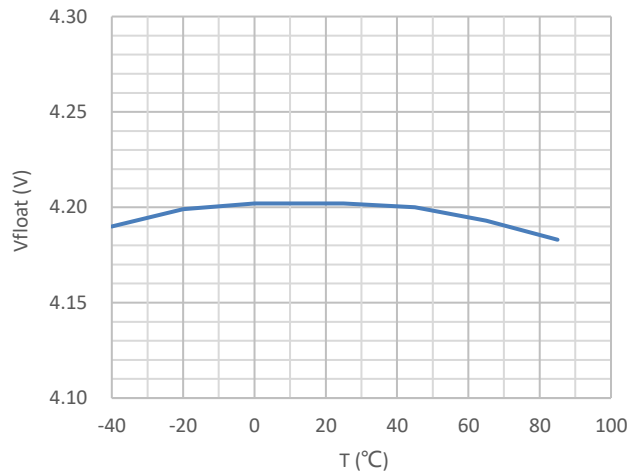

Recharge Voltage vs. Temp

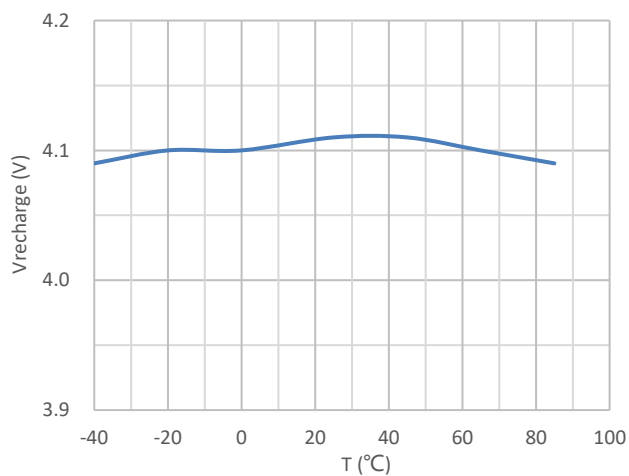

Trickle Charge Voltage vs. Temp

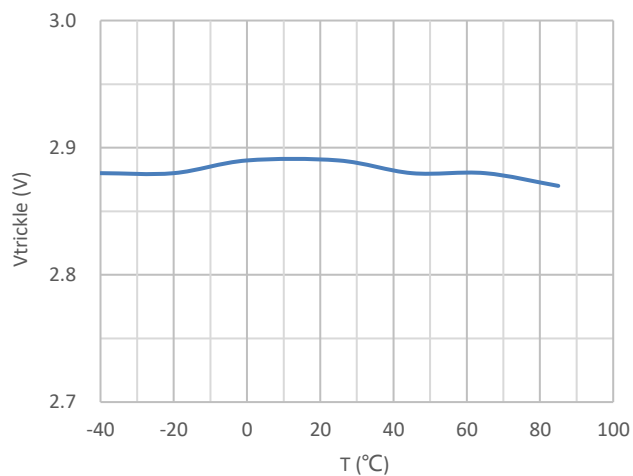

DETAILED DESCRIPTION

The BL8576 is a single cell, fully integrated constant current (CC)/constant voltage (CV) Li-ion battery charger. It can deliver up to 1A of charge current with a final float voltage accuracy of $\pm 1\%$. The BL8576 has a build-in thermal regulation circuitry that ensures its safe operation. No blocking diode or external current sense resistor is required; hence reduce the external components for a basic charger circuit to two. The BL8576 is also capable of operating from a USB power source.

Normal charge cycle

The BL8576 initiates a charge cycle once the voltage at the VCC pin rises above the UVLO threshold level. A $\pm 1\%$ precision resistor needs to be connected from the PROG pin to ground. If the voltage at the BAT pin is less than 2.9V, the charger enters trickle charge mode. In this mode, the charge current is reduced to nearly 1/10 the programmed value until the battery voltage is raised to a safe level for full current charging.

The charger switches to constant-current mode as the BAT pin voltage rises above 2.9V, the charge current is thus resumed to full programmed value. When the final float voltage (4.2V) is reached, the BL8576 enters constant-voltage mode and the charge current begins to decrease until it drops to 1/10 of the preset value and ends the charge cycle.

Programming charge current

The charge current is programmable by setting the value of a precision resistor connected from the PROG pin to ground. The charge current is 1000 times of the current out of the PROG pin. The program resistor and the charge current are calculated using the following equations:

$$R_{PROG} = \frac{1000V}{I_{CHG}}$$

The charge current out of the BAT pin can be determined at any time by monitoring the PROG pin voltage using the following equation:

$$I_{BAT} = \frac{V_{PROG}}{R_{PROG}} \cdot 1000$$

BL8576 has a self-temperature-limiting (STL) function, the chip starts to limit its charge current by reducing VPROG gradually after silicon temperature rises above 120°C. Say if the difference of junction and ambient temperature is 45°C at certain power rating, BL8576 would have the same charge current and junction

temperature as chips without STL function at room temperature. As the ambient temperature rises up to 105°C, a chip without STL would have 130°C of junction temperature, while BL8576 would reduce its charge current and hence the junction temperature would be much lower. The STL function helps to improve system reliability.

Charge termination

The BL8576 keeps monitoring the PROG pin during the charging process. It terminates the charge cycle when the charge current falls to 1/10 the programmed value after the final float voltage is reached. When the PROG pin voltage falls below 100mV for longer than t_{TERM} (typically 1ms), charging is terminated. The charge current is latched off and the BL8576 enters standby mode, where the input supply current drops to 50µA. (Note: C/10 termination is disabled in trickle charging and thermal limiting modes).

During charging, the transient response of the circuit can cause the PROG pin to fall below 100mV temporarily before the battery is fully charged, thus can cause a premature termination of the charge cycle. A 1ms filter time (t_{TERM}) on the termination comparator can prevent this from happening. Once the average charge current drops below 1/10 the

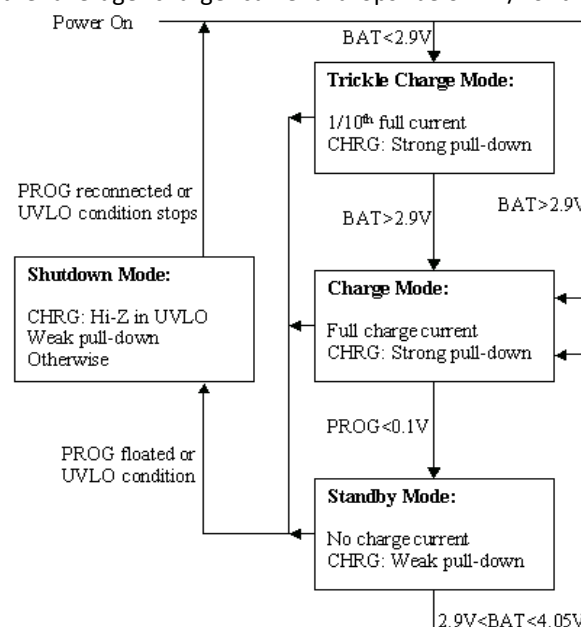

Figure 1. Charge Cycle Diagram

programmed value, the BL8576 terminates the charge cycle and ceases to provide any current through the BAT pin. In this state, all loads on the BAT pin must be supplied by the battery.

The BL8576 constantly monitors the BAT pin voltage in standby mode and resume another charge cycle if this voltage drops below the recharge threshold (VRECHRG). User can also manually restart a charge cycle in standby mode either by removing and then reapplied the input voltage or restart the charger using the PROG pin. A diagram of typical charge cycle is shown in Figure 1.

Charge status indicator (\overline{CHRG})

There are two different states of the charge status output, namely pull-down and high impedance. The pull-down state indicates that the BL8576 is in a charge cycle. When the charge cycle has terminated, the pin state is then determined by under voltage lockout conditions.

Thermal limiting

Build-in feedback circuitry mechanism can reduce the value of the programmed charge current once the die temperature tends to rise above 120°C, hence prevents the temperature from further increase and ensure device safe operation.

Under voltage lockout (UVLO)

Build-in under voltage lockout circuit monitors the input voltage and keeps the charger in shutdown

APPLICATIONS INFORMATION

Stability considerations

When a battery is connected to the output, the constant-voltage mode feedback is always stable. However, in the case of absence of battery, an output capacitor is recommended to reduce ripple voltage. In the case of high value capacitance or low ESR ceramic capacitors, a small value series resistor ($\sim 1\Omega$) is recommended. No series resistor is needed if tantalum capacitors are used.

In constant-current mode, the PROG pin is in the feedback loop, thus its impedance affects the stability. The maximum allowed value of the program resistor is 20K, and additional capacitance reduces this value. The pole frequency at the PROG pin needs to be kept above 100kHz to maintain device stability. Therefore, the maximum resistance value can be calculated from the following equation, C_{PROG} is the capacitance loaded to the PROG pin

$$R_{PROG} \leq \frac{1}{2\pi \cdot 10^5 \cdot C_{PROG}}$$

mode until VCC rises above the under voltage lockout threshold. The UVLO circuit has a built-in hysteresis of 200mV. Furthermore, to protect against reverse current in the power MOSFET, the UVLO circuit keeps the charger in shutdown mode if VCC falls to within 80mV of the battery voltage. If the UVLO comparator is tripped, the charger will not come out of shutdown mode until VCC rises 130mV above the battery voltage.

Manual shutdown

Floating the PROG pin by removing the resistor from PROG pin to ground can put the device in shutdown mode. The battery drain current is thus reduced to less than 5μA and the supply current to less than 50μA. Reconnecting the resistor back will restart a new charge cycle.

The \overline{CHRG} pin is in a high impedance state if the BL8576 is in under voltage lockout mode.

Automatic recharge

After the termination of the charge cycle, the BL8576 constantly monitors the BAT pin voltage and starts a new charge cycle when the battery voltage falls below 4.05V, keeping the battery at fully charged condition. \overline{CHRG} output enters a pull-down state during recharge cycles.

Average rather than instantaneous charge current is more of a concern. A simple low pass filter can be used on the PROG pin to measure the average battery current as shown in Figure 2. A 10K resistor has been added between the PROG pin and the filter capacitor to ensure stability.

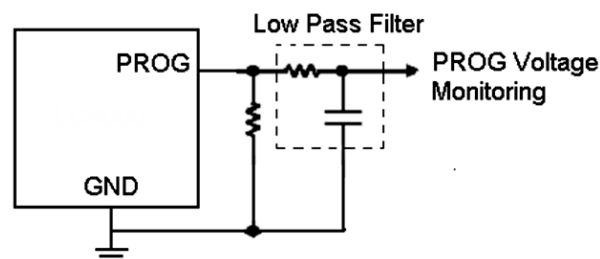

Figure 2. Isolating Capacitive Load on PROG Pin and Filtering

Power dissipation

The power dissipated in the IC causes the rise of die temperature. Most of the power dissipation is caused

by the internal power MOSFET, and can be calculated by the following equation:

$$P_D = (V_{CC} - V_{BAT}) \cdot I_{BAT}$$

Where PD is the power dissipated, VCC is the input supply voltage, VBAT is the battery voltage and IBAT is the charge current. The approximate ambient temperature at which the thermal feedback begins to protect the IC is:

$$T_A = 120^\circ C - P_D \theta_{JA}$$

$$T_A = 120^\circ C - (V_{CC} - V_{BAT}) \cdot I_{BAT} \cdot \theta_{JA}$$

Example: An BL8576 operating from a 5V USB supply is programmed to supply 400mA full-scale current to a discharged Li-Ion battery with a voltage of 3.75V.

Assuming θ_{JA} is $70^\circ C / W$ (see Board Layout Considerations), the ambient temperature at which the BL8576 will begin to reduce the charge current is approximately:

$$T_A = 120^\circ C - (5V - 3.75V) \cdot (400mA) \cdot 70^\circ C / W$$

$$T_A = 120^\circ C - 0.5W \cdot 70^\circ C / W = 120^\circ C - 35^\circ C$$

$$T_A = 85^\circ C$$

The BL8576 can be used above $85^\circ C$ ambient, but the charge current will be reduced from 400mA. The approximate current at a given ambient temperature can be approximated by:

$$I_{BAT} = \frac{120^\circ C - T_A}{(V_{CC} - V_{BAT}) \cdot \theta_{JA}}$$

Using the previous example with an ambient temperature of $60^\circ C$, the charge current will be reduced to approximately:

$$I_{BAT} = \frac{120^\circ C - 60^\circ C}{(5V - 3.75V) \cdot 70^\circ C / W} = \frac{60^\circ C}{87.5^\circ C / A}$$

$$I_{BAT} = 685mA$$

Moreover, when thermal feedback reduces the charge current, the voltage at the PROG pin is also reduced proportionally as discussed in the operation section.

It is important to remember that BL8576 applications do not need to be designed for worst-case thermal conditions since the IC will automatically reduce power dissipation when the junction temperature reaches approximately $120^\circ C$.

Thermal considerations

Due to its compact size, it is of great importance to use a good thermal PC board. Good thermal conduction increases maximum allowed charge current value.

The thermal path for the heat generated by the IC is from the die to the copper lead frame, through the package leads, (especially the ground lead) to the PC board copper. The PC board copper is the heat sink. The footprint copper pads should be as wide as possible and expand out to larger copper areas to spread and dissipate the heat to the surrounding ambient. Feed through vias to inner or backside copper layers are also useful in improving the overall thermal performance of the charger. Other heat sources on the board, not related to the charger, must also be considered when designing a PC board layout because they will affect overall temperature rise and the maximum charge current.

VCC bypass capacitor

Due to their self-resonant and high Q characteristics, some types of ceramic capacitors can cause high voltage transients under some start-up conditions (i.e connecting the charger input to a live power source). Adding a small value resistor in series with the ceramic capacitor can minimize start-up voltage transients

Charge current soft-start

To avoid the start-up transients, a soft-start circuit is included to ramp the charge current from zero to programmed value over a period of time. This has the effect of minimizing the transient current load on the power supply during start-up.

PACKAGE OUTLINE

