

---

## 4 MHz PWM 2A Buck Regulator with HyperLight Load<sup>®</sup> and Power Good

---

### Features

- Input Voltage: 2.7V to 5.5V
- Output Voltage: Fixed or Adjustable (0.62V to 3.6V)
- Up to 2A Output Current
- Up to 93% Peak Efficiency
- 85% Typical Efficiency at 1 mA
- Power Good (PG) Output
- Programmable Soft-Start
- 22  $\mu$ A Typical Quiescent Current
- 4 MHz PWM Operation in Continuous Mode
- Ultra-Fast Transient Response
- Low Ripple Output Voltage:
  - 35 mV<sub>PP</sub> Ripple in HyperLight Load<sup>®</sup> Mode
  - 5 mV Output Voltage Ripple in Full PWM Mode
- Fully Integrated MOSFET Switches
- 0.01  $\mu$ A Shutdown Current
- Thermal Shutdown and Current Limit Protection
- 10-Pin 2.5 mm x 2.5 mm Thin DFN Package
- -40°C to +125°C Junction Temperature Range

### Applications

- Solid State Drives (SSD)
- Mobile Handsets
- Portable Media/MP3 Players
- Portable Navigation Devices (GPS)
- WiFi/WiMax/WiBro Modules
- Wireless LAN Cards
- Portable Applications

### General Description

The MIC23153 is a high-efficiency 4 MHz 2A synchronous buck regulator with HyperLight Load<sup>®</sup> mode, Power Good (PG) output indicator, and programmable soft-start. HyperLight Load<sup>®</sup> provides very high efficiency at light loads and ultra-fast transient response that makes the MIC23153 perfectly suited for supplying processor core voltages.

An additional benefit of this proprietary architecture is very low output ripple voltage throughout the entire load range with the use of small output capacitors. The tiny 2.5 mm x 2.5 mm thin DFN package saves precious board space and requires only four external components.

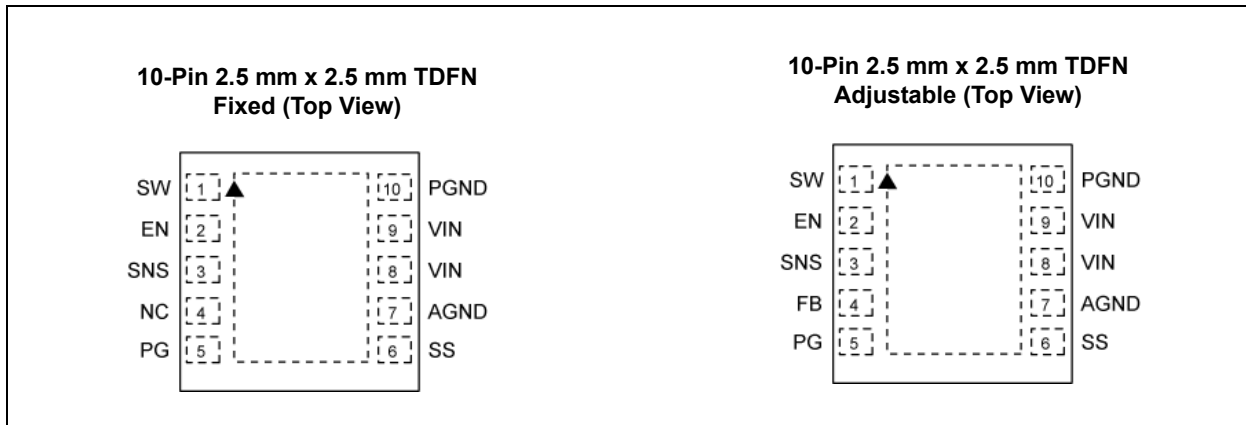
The MIC23153 is designed for use with a very small inductor, down to 0.47  $\mu$ H, and an output capacitor as small as 2.2  $\mu$ F that enables a total solution size, less than 1 mm in height.

The MIC23153 has a very-low quiescent current of 22  $\mu$ A and achieves a peak efficiency of 93% in continuous conduction mode. In discontinuous conduction mode, the MIC23153 can achieve 85% efficiency at 1 mA.

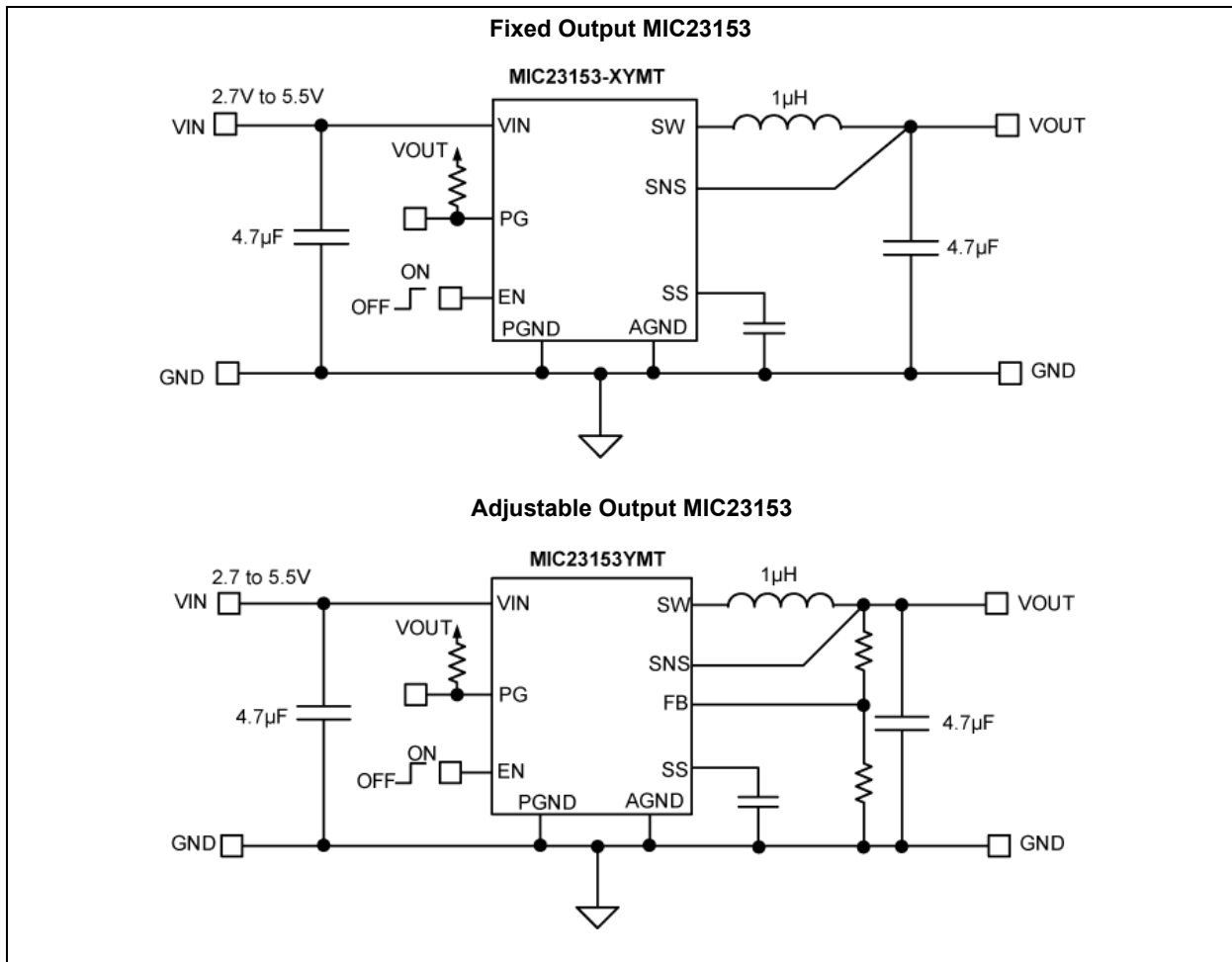
The MIC23153 is available in 10-pin 2.5 mm x 2.5 mm TDFN package with an operating junction temperature range from -40°C to +125°C.

# MIC23153

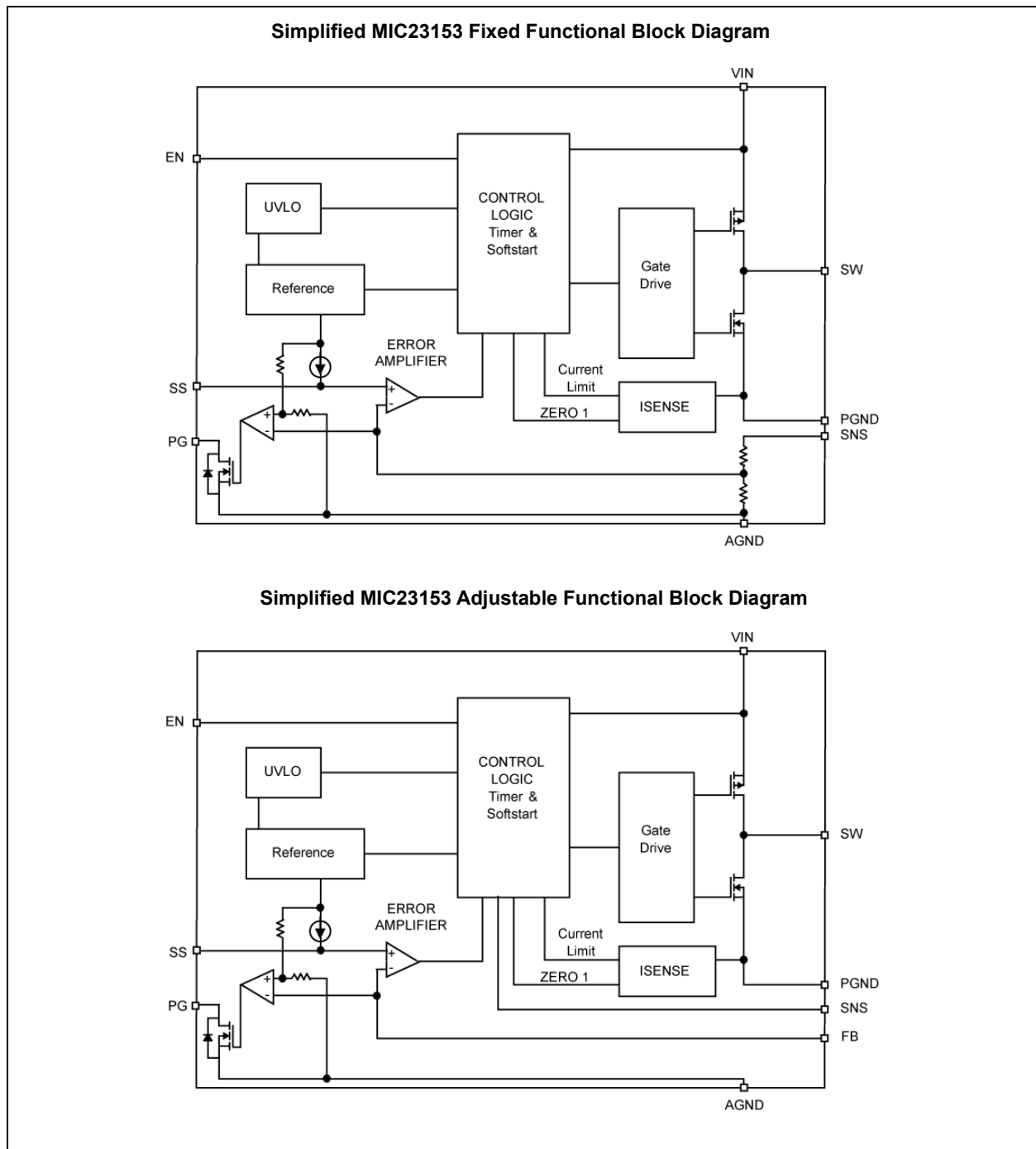
## Package Types



## Typical Application Circuits



## Functional Block Diagrams



# MIC23153

## 1.0 ELECTRICAL CHARACTERISTICS

### Absolute Maximum Ratings †

Supply Voltage ( $V_{IN}$ )	-0.3 to +6V
Sense Voltage ( $V_{SNS}$ )	-0.3 to $V_{IN}$
Output Switch Voltage ( $V_{SW}$ )	-0.3 to $V_{IN}$
Enable Input Voltage ( $V_{EN}$ )	-0.3 to $V_{IN}$
Power Good (PG) Voltage ( $V_{PG}$ )	-0.3 to $V_{IN}$
ESD Rating (Note 1)	ESD Sensitive

### Operating Ratings ‡

Supply Voltage ( $V_{IN}$ )	+2.7V to +5.5V
Enable Input Voltage ( $V_{EN}$ )	0V to $V_{IN}$
Sense Voltage ( $V_{SNS}$ )	0.62V to 3.6V

† **Notice:** Stresses above those listed under “Absolute Maximum Ratings” may cause permanent damage to the device. This is a stress rating only and functional operation of the device at those or any other conditions above those indicated in the operational sections of this specification is not intended. Exposure to maximum rating conditions for extended periods may affect device reliability. Specifications are for packaged product only.

‡ **Notice:** The device is not guaranteed to function outside its operating ratings.

**Note 1:** Devices are ESD sensitive. Handling precautions are recommended. Human body model, 1.5 k $\Omega$  in series with 100 pF.

## ELECTRICAL CHARACTERISTICS

**Electrical Characteristics:**  $T_A = 25^\circ\text{C}$ ,  $V_{IN} = V_{EN} = 3.6\text{V}$ ;  $L = 1\ \mu\text{H}$ ;  $C_{OUT} = 4.7\ \mu\text{F}$ ; unless otherwise specified. **Bold** values indicate  $-40^\circ\text{C} \leq T_J \leq +125^\circ\text{C}$ . Specification for packaged product only.

Parameter	Symbol	Min.	Typ.	Max.	Units	Conditions
Supply Voltage Range	—	<b>2.7</b>	—	<b>5.5</b>	V	—
Undervoltage Lockout Threshold	$V_{UVLO}$	<b>2.45</b>	2.55	<b>2.65</b>	V	Turn-On
Undervoltage Lockout Hysteresis	—	—	75	—	mV	—
Quiescent Current	$I_Q$	—	22	<b>45</b>	$\mu\text{A}$	$I_{OUT} = 0\ \text{mA}$ , $SNS > 1.2 \times V_{OUT(NOM)}$
Shutdown Current	$I_{SHD}$	—	0.01	<b>5</b>	$\mu\text{A}$	$V_{EN} = 0\text{V}$ ; $V_{IN} = 5.5\text{V}$
Output Voltage Accuracy	$V_{OUT\_ACC}$	<b>-2.5</b>	—	<b>+2.5</b>	%	$V_{IN} = 3.6\text{V}$ if $V_{OUT(NOM)} < 2.5\text{V}$ , $I_{LOAD} = 20\ \text{mA}$
						$V_{IN} = 4.5\text{V}$ if $V_{OUT(NOM)} \geq 2.5\text{V}$ $I_{LOAD} = 20\ \text{mA}$
Feedback Regulation Voltage	$V_{REF}$	<b>0.6045</b>	0.62	<b>0.635</b>	V	$I_{LOAD} = 20\ \text{mA}$
Current Limit	$I_{LIM}$	<b>2.2</b>	3.3	—	A	$SNS = 0.9 \times V_{OUT(NOM)}$
Output Voltage Line Regulation	—	—	0.3	—	%/ $V$	$V_{IN} = 3.6\text{V}$ to $5.5\text{V}$ if $V_{OUT(NOM)} < 2.5\text{V}$ , $I_{LOAD} = 20\ \text{mA}$
				—		$V_{IN} = 4.5\text{V}$ to $5.5\text{V}$ if $V_{OUT(NOM)} \geq 2.5\text{V}$ , $I_{LOAD} = 20\ \text{mA}$

## ELECTRICAL CHARACTERISTICS (CONTINUED)

**Electrical Characteristics:**  $T_A = 25^\circ\text{C}$ ,  $V_{IN} = V_{EN} = 3.6\text{V}$ ;  $L = 1\ \mu\text{H}$ ;  $C_{OUT} = 4.7\ \mu\text{F}$ ; unless otherwise specified. **Bold** values indicate  $-40^\circ\text{C} \leq T_J \leq +125^\circ\text{C}$ . Specification for packaged product only.

Parameter	Symbol	Min.	Typ.	Max.	Units	Conditions
Output Voltage Load Regulation	—	—	0.3	—	%	20 mA < $I_{LOAD}$ < 500 mA, $V_{IN} = 3.6\text{V}$ if $V_{OUT(NOM)} < 2.5\text{V}$
		—				20 mA < $I_{LOAD}$ < 500 mA, $V_{IN} = 5.0\text{V}$ if $V_{OUT(NOM)} \geq 2.5\text{V}$
		—	0.7	—	%	20 mA < $I_{LOAD}$ < 1A, $V_{IN} = 3.6\text{V}$ if $V_{OUT(NOM)} < 2.5\text{V}$
		—				20 mA < $I_{LOAD}$ < 1A, $V_{IN} = 5.0\text{V}$ if $V_{OUT(NOM)} \geq 2.5\text{V}$
PWM Switch On-Resistance	$R_{DSON,P}$	—	0.2	—	$\Omega$	$I_{SW} = 100\ \text{mA PMOS}$
	$R_{DSON,N}$	—	0.19	—		$I_{SW} = -100\ \text{mA NMOS}$
Switching Frequency	$F_{SW}$	—	4	—	MHz	$I_{OUT} = 120\ \text{mA}$
Soft-Start Time	—	—	320	—	$\mu\text{s}$	$V_{OUT} = 90\%$ , $C_{SS} = 470\ \text{pF}$
Soft-Start Current	—	—	2.7	—	$\mu\text{A}$	$V_{SS} = 0\text{V}$
Power Good Threshold (Rising)	—	86	92	96	%	—
Power Good Threshold Hysteresis	—	—	7	—	%	—
Power Good Delay Time	—	—	68	—	$\mu\text{s}$	Rising
Enable Threshold	$V_{EN}$	<b>0.5</b>	0.9	<b>1.2</b>	V	Turn-On
Enable Input Current	—	—	0.1	<b>2</b>	$\mu\text{A}$	—
Overtemperature Shutdown	$T_{SHD}$	—	160	—	$^\circ\text{C}$	—
Overtemperature Shutdown Hysteresis	$T_{SHD\_HYST}$	—	20	—	$^\circ\text{C}$	—

# MIC23153

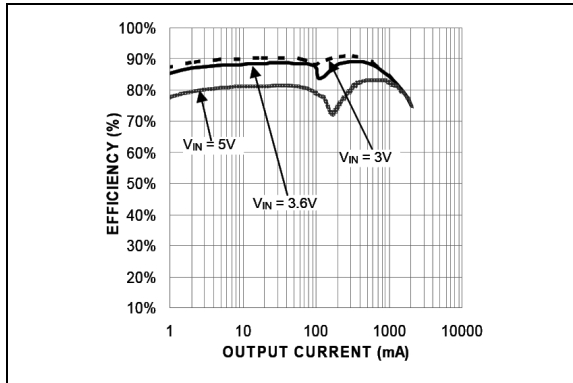
## TEMPERATURE SPECIFICATIONS (Note 1)

Parameters	Sym.	Min.	Typ.	Max.	Units	Conditions
<b>Temperature Ranges</b>						
Junction Temperature Range	$T_J$	-40	—	+125	°C	—
Storage Temperature Range	$T_S$	-65	—	+150	°C	—
Lead Temperature	—	—	—	+260	°C	Soldering, 10 seconds
<b>Package Thermal Resistances</b>						
Thermal Resistance TDFN 2.5 mm x 2.5 mm	$\theta_{JA}$	—	90	—	°C/W	—
Thermal Resistance TDFN 2.5 mm x 2.5 mm	$\theta_{JC}$	—	63	—	°C/W	—

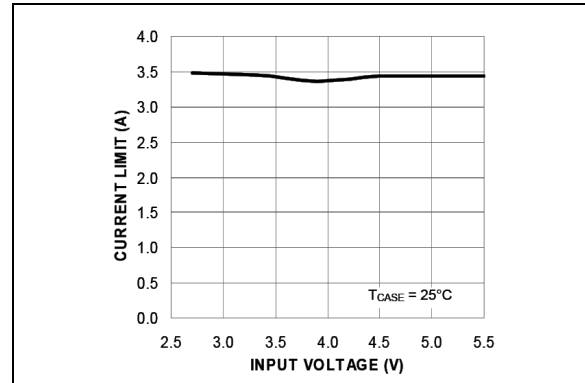
**Note 1:** The maximum allowable power dissipation is a function of ambient temperature, the maximum allowable junction temperature and the thermal resistance from junction to air (i.e.,  $T_A$ ,  $T_J$ ,  $\theta_{JA}$ ). Exceeding the maximum allowable power dissipation will cause the device operating junction temperature to exceed the maximum +125°C rating. Sustained junction temperatures above +125°C can impact the device reliability.

## 2.0 TYPICAL PERFORMANCE CURVES

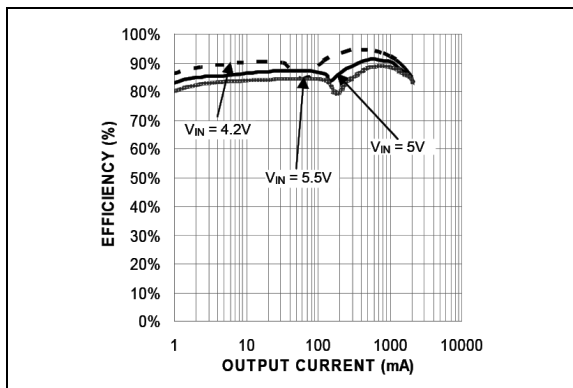
**Note:** The graphs and tables provided following this note are a statistical summary based on a limited number of samples and are provided for informational purposes only. The performance characteristics listed herein are not tested or guaranteed. In some graphs or tables, the data presented may be outside the specified operating range (e.g., outside specified power supply range) and therefore outside the warranted range.



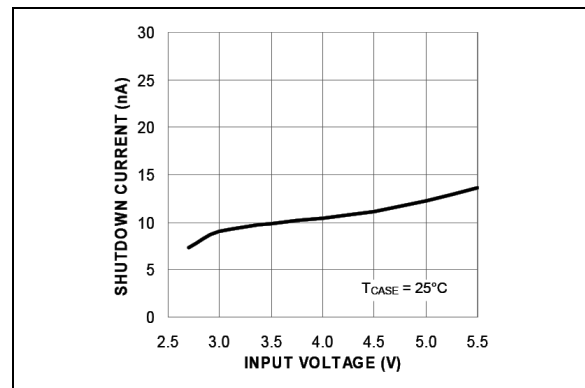
**FIGURE 2-1:** Efficiency vs. Output Current ( $V_{OUT} = 1.8V @ 25^{\circ}C$ ).



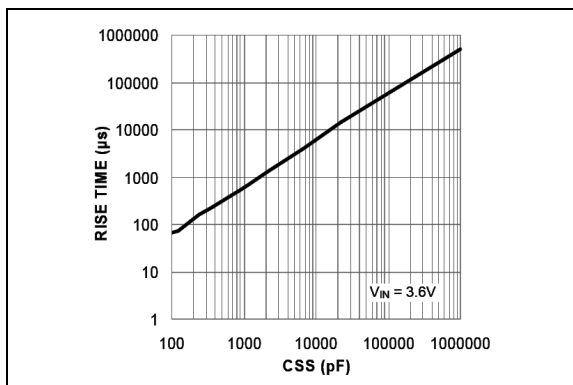
**FIGURE 2-4:** Current Limit vs Input Voltage.



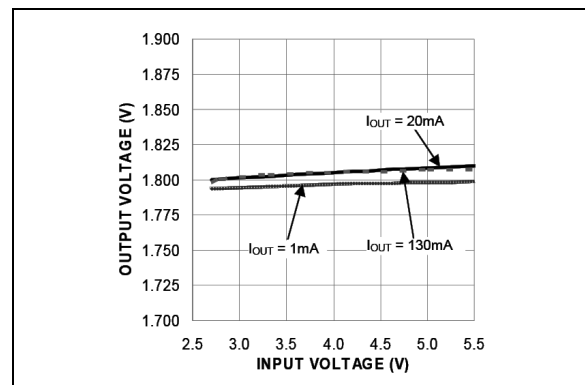
**FIGURE 2-2:** Efficiency vs. Output Current ( $V_{OUT} = 3.3V @ 25^{\circ}C$ ).



**FIGURE 2-5:** Shutdown Current vs Input Voltage.

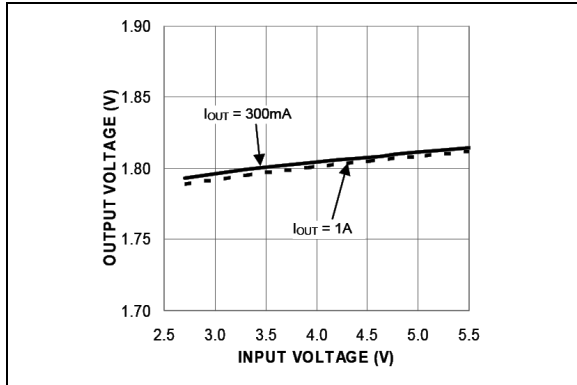


**FIGURE 2-3:**  $V_{OUT}$  Rise Time vs.  $C_{SS}$ .

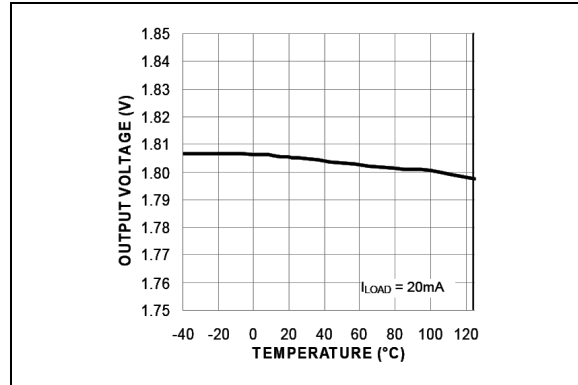


**FIGURE 2-6:** Line Regulation (Low Loads).

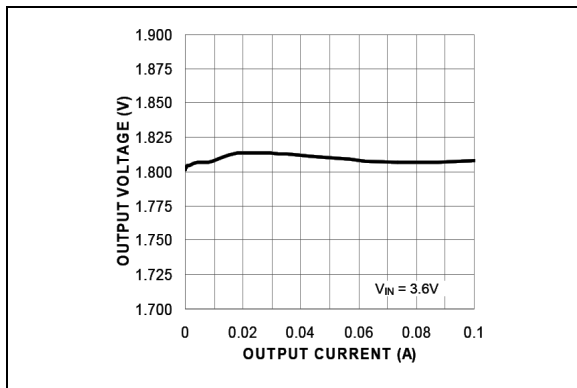
# MIC23153



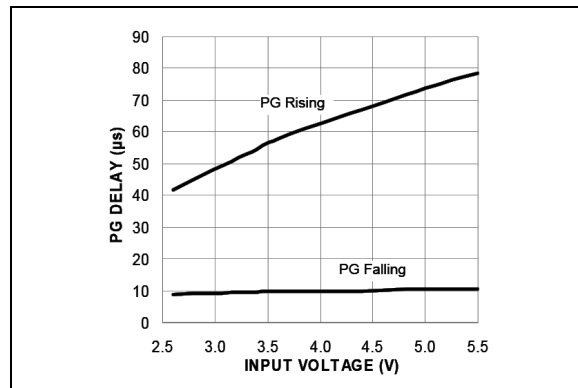
**FIGURE 2-7:** Line Regulation (High Loads).



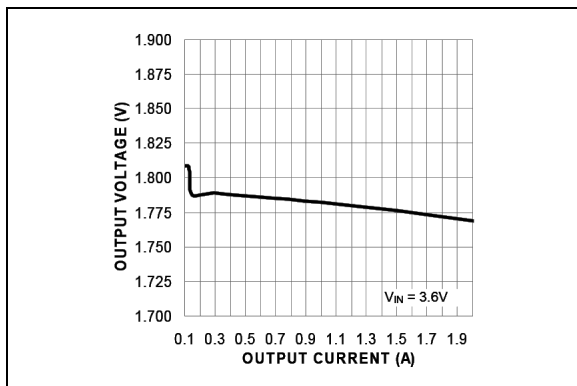
**FIGURE 2-10:** Output Voltage vs. Temperature.



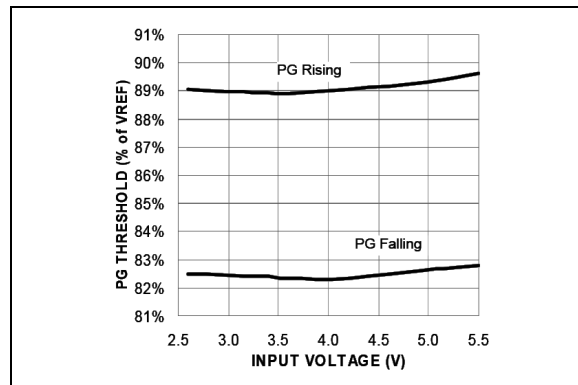
**FIGURE 2-8:** Output Voltage vs. Output Current (HLL).



**FIGURE 2-11:** Power Good Delay Time vs. Input Voltage.

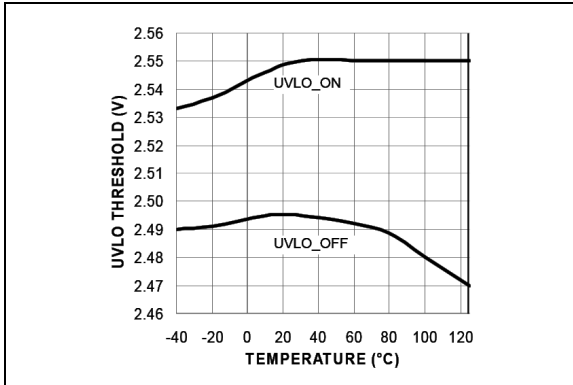


**FIGURE 2-9:** Output Voltage vs. Output Current (CCM).

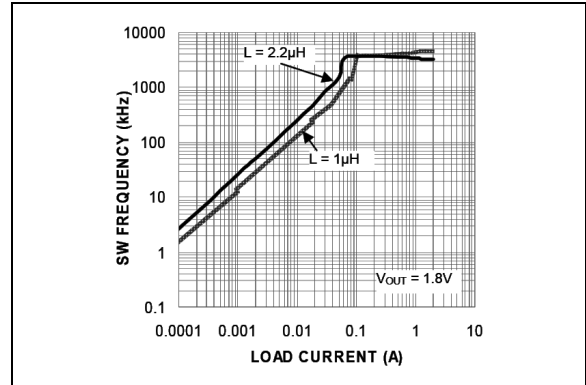


**FIGURE 2-12:** Power Good Thresholds vs. Input Voltage.

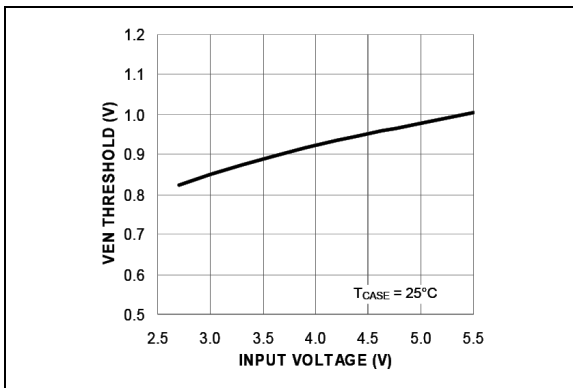




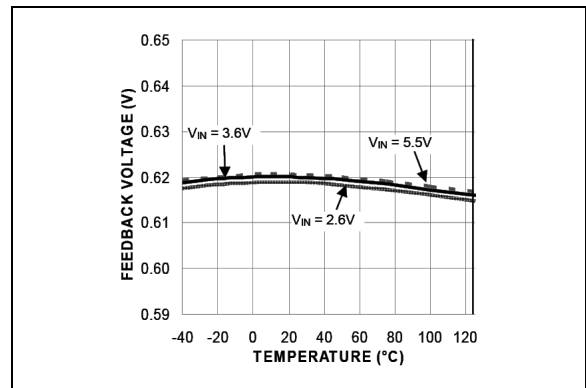
**FIGURE 2-13:** UVLO Threshold vs. Temperature.



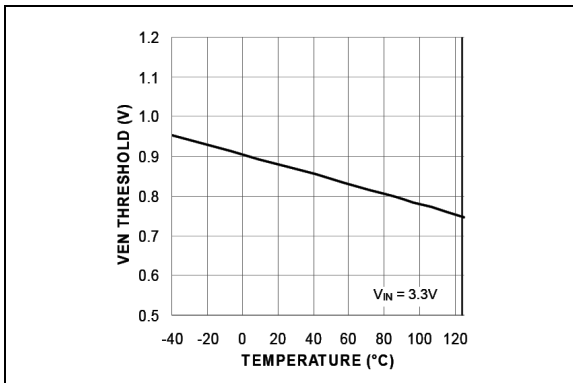
**FIGURE 2-16:** Switching Frequency vs. Load Current.



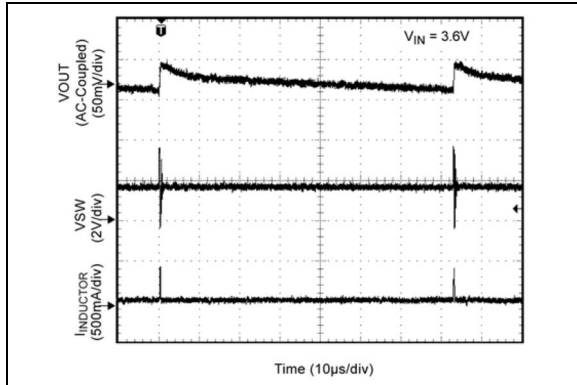
**FIGURE 2-14:** Enable Threshold vs. Input Voltage.



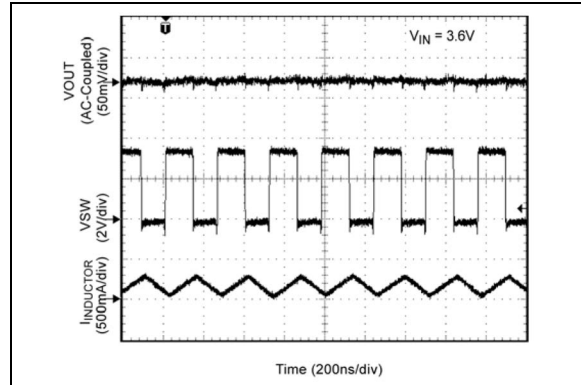
**FIGURE 2-17:** Feedback Voltage vs. Temperature.



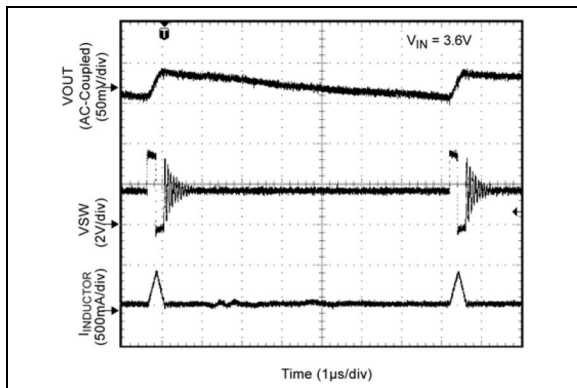
**FIGURE 2-15:** Enable Threshold vs. Temperature.



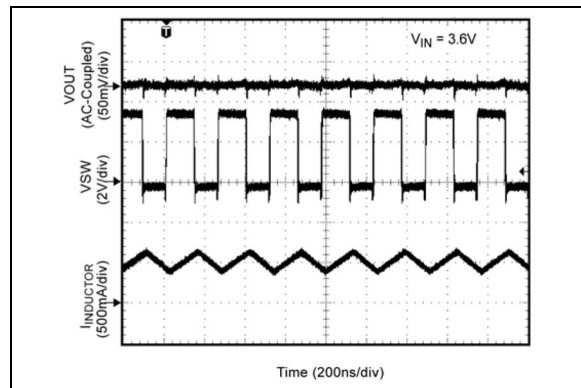
**FIGURE 2-18:** Switching Waveform Discontinuous Mode (Load = 1 mA).



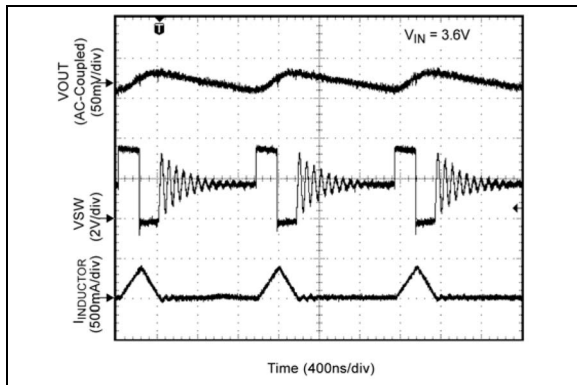
**FIGURE 2-21:** Switching Waveform Continuous Mode (Load = 150 mA).



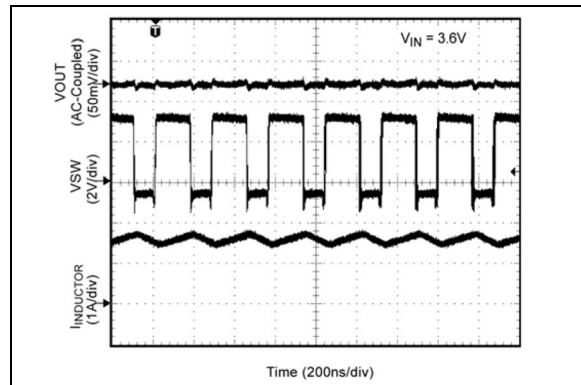
**FIGURE 2-19:** Switching Waveform Discontinuous Mode (Load = 10 mA).



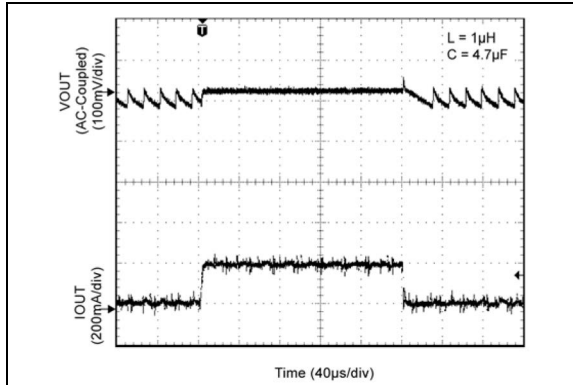
**FIGURE 2-22:** Switching Waveform Continuous Mode (Load = 500 mA).



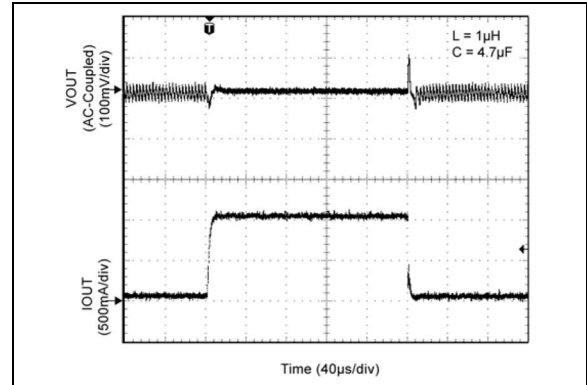
**FIGURE 2-20:** Switching Waveform Discontinuous Mode (Load = 50 mA).



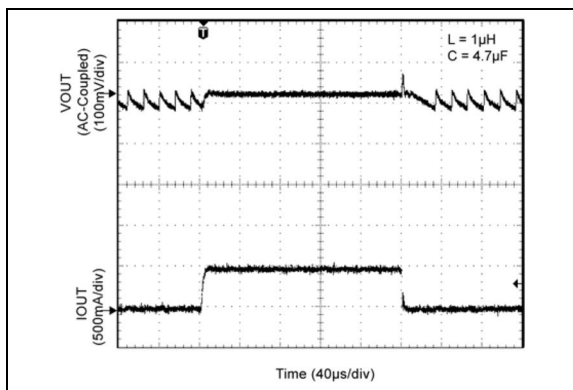
**FIGURE 2-23:** Switching Waveform Continuous Mode (Load = 1.5A).



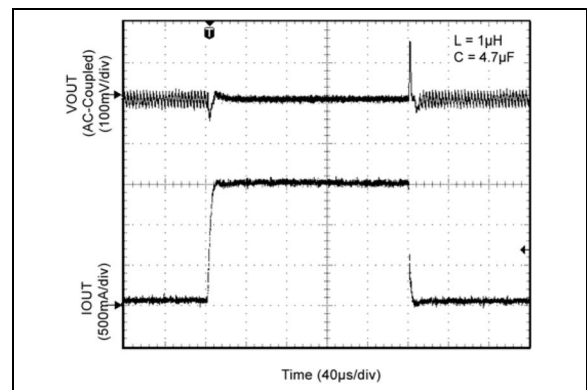
**FIGURE 2-24:** Load Transient (10 mA to 200 mA).



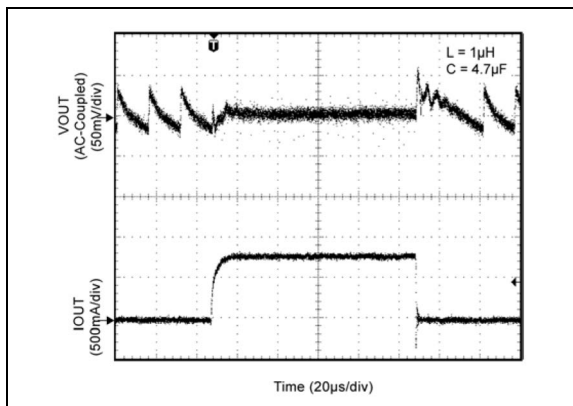
**FIGURE 2-27:** Load Transient (50 mA to 1A).



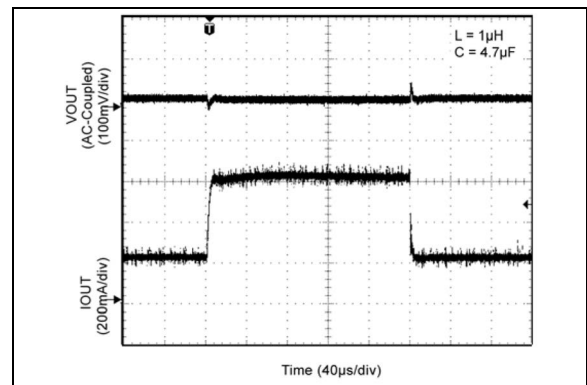
**FIGURE 2-25:** Load Transient (10 mA to 500 mA).



**FIGURE 2-28:** Load Transient (50 mA to 1.5A).

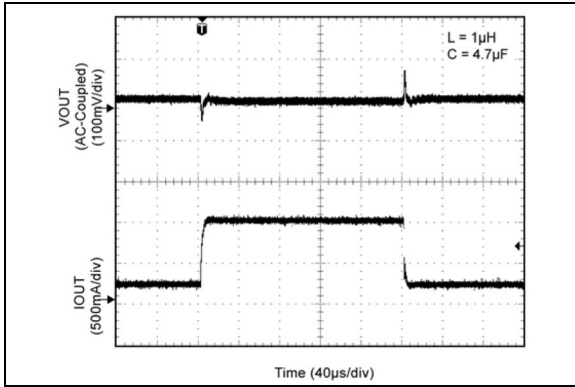


**FIGURE 2-26:** Load Transient (10 mA to 750 mA).

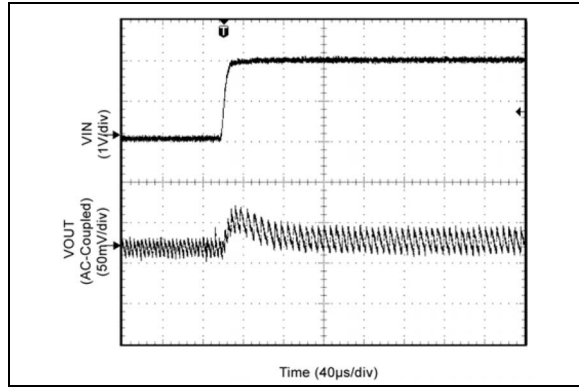


**FIGURE 2-29:** Load Transient (200 mA to 600 mA).

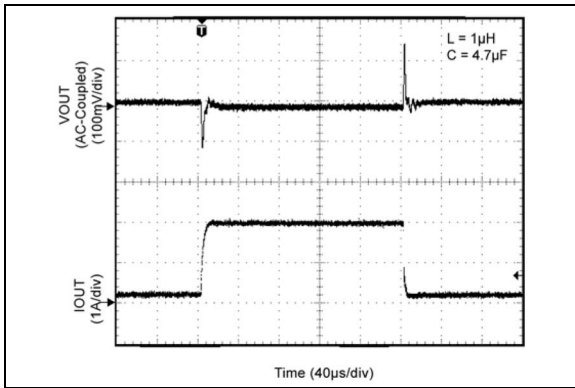
# MIC23153



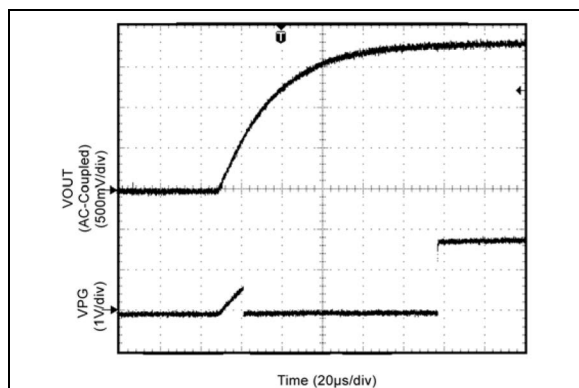
**FIGURE 2-30:** Load Transient (200 mA to 1A).



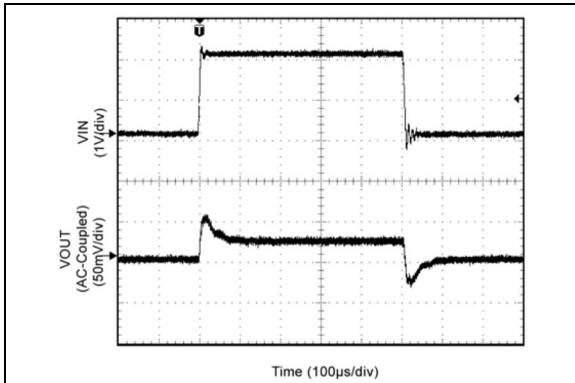
**FIGURE 2-33:** Line Transient (3.6V to 5.5V @ 20 mA Load).



**FIGURE 2-31:** Load Transient (200 mA to 2A).



**FIGURE 2-34:** Start-Up and Power Good Waveform.



**FIGURE 2-32:** Line Transient (3.6V to 5.5V @ 1.5A Load).

## 3.0 PIN DESCRIPTIONS

The descriptions of the pins are listed in [Table 3-1](#).

**TABLE 3-1: PIN FUNCTION TABLE**

Pin Number (Fixed)	Pin Number (Adjustable)	Pin Name	Description
1	1	SW	Switch (Output): Internal power MOSFET output switches.
2	2	EN	Enable (Input): Logic high enables operation of the regulator. Logic low will shut down the device. Do not leave floating.
3	3	SNS	Sense: Connect to $V_{OUT}$ as close to output capacitor as possible to sense output voltage.
4	—	NC	Not Internally Connected.
—	4	FB	Feedback: Connect a resistor divider from the output to ground to set the output voltage.
5	5	PG	Power Good: Open-drain output for the power good indicator. Use a pull-up resistor from this pin to a voltage source to detect a power good condition.
6	6	SS	Soft-Start: Place a capacitor from this pin to ground to program the soft start time. Do not leave floating, 100 pF minimum $C_{SS}$ is required.
7	7	AGND	Analog Ground: Connect to central ground point where all high current paths meet ( $C_{IN}$ , $C_{OUT}$ , PGND) for best operation.
8, 9	8, 9	VIN	Input Voltage: Connect a capacitor to ground to decouple the noise.
10	10	PGND	Power Ground.

# MIC23153

## 4.0 FUNCTIONAL DESCRIPTION

### 4.1 VIN

The input supply (VIN) provides power to the internal MOSFETs for the switch mode regulator along with the internal control circuitry. The VIN operating range is 2.7V to 5.5V so an input capacitor, with a minimum voltage rating of 6.3V, is recommended. Due to the high switching speed, a minimum 2.2  $\mu$ F bypass capacitor placed close to VIN and the power ground (PGND) pin is required.

### 4.2 EN

A logic high signal on the enable pin activates the output voltage of the device. A logic low signal on the enable pin deactivates the output and reduces supply current to 0.01  $\mu$ A. MIC23153 features external soft start circuitry via the soft-start (SS) pin that reduces inrush current and prevents the output voltage from overshooting at start up. Do not leave the EN pin floating.

### 4.3 SW

The switch (SW) connects directly to one end of the inductor and provides the current path during switching cycles. The other end of the inductor is connected to the load, SNS pin and output capacitor. Due to the high speed switching on this pin, the switch node should be routed away from sensitive nodes whenever possible.

### 4.4 SNS

The sense (SNS) pin is connected to the output of the device to provide feedback to the control circuitry. The SNS connection should be placed close to the output capacitor.

### 4.5 AGND

The analog ground (AGND) is the ground path for the biasing and control circuitry. The current loop for the signal ground should be separate from the power ground (PGND) loop.

### 4.6 PGND

The power ground pin is the ground path for the high current in PWM mode. The current loop for the power ground should be as small as possible and separate from the analog ground (AGND) loop as applicable.

### 4.7 Power Good (PG)

The Power Good (PG) pin is an open drain output which indicates logic high when the output voltage is typically above 92% of its steady state voltage. A pull up resistor of more than 5 k $\Omega$  should be connected from PG to V<sub>OUT</sub>.

### 4.8 Soft-Start

The soft-start (SS) pin is used to control the output voltage ramp up time. The approximate equation for the ramp time in milliseconds is:

#### EQUATION 4-1:

$$t(ms) = 270 \times 10^3 \times In(10) \times C_{SS}$$

Where:

t = The time in milliseconds

C<sub>SS</sub> = External soft-start capacitance (in Farads)

For example, for a C<sub>SS</sub> = 470 pF, t<sub>RISE</sub> ~ 0.3 ms or 300  $\mu$ s. See [Section 2.0, Typical Performance Curves](#) for a graphical guide. The minimum recommended value for C<sub>SS</sub> is 100 pF.

### 4.9 FB

The feedback (FB) pin is provided for the adjustable voltage option (no internal connection for fixed options). This is the control input for programming the output voltage. A resistor divider network is connected to this pin from the output and is compared to the internal 0.62V reference within the regulation loop.

The output voltage can be programmed between 0.65V and 3.6V using the following equation:

#### EQUATION 4-2:

$$V_{OUT} = V_{REF} \left( 1 + \frac{R1}{R2} \right)$$

Where:

R1 = Top resistor

R2 = Bottom resistor

Example feedback resistor values:

**TABLE 4-1: FEEDBACK RESISTOR VALUES**

V <sub>OUT</sub>	R1	R2
1.2V	274 k $\Omega$	294 k $\Omega$
1.5V	316 k $\Omega$	221 k $\Omega$
1.8V	301 k $\Omega$	158 k $\Omega$
2.5V	324 k $\Omega$	107 k $\Omega$
3.3V	309 k $\Omega$	71.5 k $\Omega$

## 5.0 APPLICATIONS INFORMATION

The MIC23153 is a high performance DC-to-DC step-down regulator offering a small solution size. Supporting an output current up to 2A inside a tiny 2.5 mm x 2.5 mm TDFN package, the IC requires only three external components while meeting today's miniature portable electronic device needs. Using the HyperLight Load<sup>®</sup> switching scheme, the MIC23153 is able to maintain high efficiency throughout the entire load range while providing ultra-fast load transient response. The following sections provide additional device application information.

### 5.1 Input Capacitor

A 2.2 μF ceramic capacitor or greater should be placed close to the VIN pin and PGND pin for bypassing. A Murata GRM188R60J475ME84D, size 0603, 4.7 μF ceramic capacitor is recommended based upon performance, size, and cost. A X5R or X7R temperature rating is recommended for the input capacitor. Y5V temperature rating capacitors, aside from losing most of their capacitance over temperature, can also become resistive at high frequencies. This reduces their ability to filter out high frequency noise.

### 5.2 Output Capacitor

The MIC23153 is designed for use with a 2.2 μF or greater ceramic output capacitor. Increasing the output capacitance will lower output ripple and improve load transient response but could also increase solution size or cost. A low equivalent series resistance (ESR) ceramic output capacitor such as the Samsung CL10B475KQ8NQNC, size 0603, 4.7 μF ceramic capacitor is recommended based upon performance, size, and cost. Both the X7R or X5R temperature rating capacitors are recommended. The Y5V and Z5U temperature rating capacitors are not recommended due to their wide variation in capacitance over temperature and increased resistance at high frequencies.

### 5.3 Inductor Selection

When selecting an inductor, it is important to consider the following factors (not necessarily in the order of importance):

- Inductance
- Rated current value
- Size requirements
- DC resistance (DCR)

The MIC23153 is designed for use with a 0.47 μH to 2.2 μH inductor. For faster transient response, a 0.47 μH inductor will yield the best result. For lower output ripple, a 2.2 μH inductor is recommended.

Maximum current ratings of the inductor are generally given in two methods; permissible DC current and saturation current. Permissible DC current can be rated either for a 40°C temperature rise or a 10% to 20% loss in inductance. Ensure the inductor selected can handle the maximum operating current. When saturation current is specified, make sure that there is enough margin so that the peak current does not cause the inductor to saturate. Peak current can be calculated as follows:

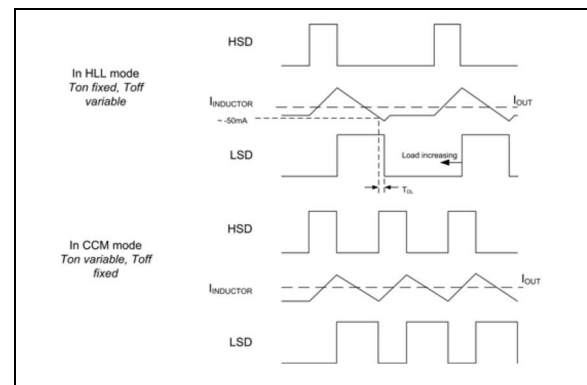
#### EQUATION 5-1:

$$I_{PEAK} = \left[ I_{OUT} + V_{OUT} \left( \frac{1 - V_{OUT}/V_{IN}}{2 \times f \times L} \right) \right]$$

As shown by the calculation above, the peak inductor current is inversely proportional to the switching frequency and the inductance; the lower the switching frequency or the inductance the higher the peak current. As input voltage increases, the peak current also increases.

DC resistance (DCR) is also important. While DCR is inversely proportional to size, DCR can represent a significant efficiency loss. Refer to the [Section 5.6 "Efficiency Considerations"](#).

The transition between high loads (CCM) to HyperLight Load<sup>®</sup> (HLL) mode is determined by the inductor ripple current and the load current.



**FIGURE 5-1:** Control Signals.

The diagram shows the signals for high side switch drive (HSD) for  $t_{ON}$  control, the inductor current and the low side switch drive (LSD) for  $t_{OFF}$  control.

In HLL mode, the inductor is charged with a fixed  $T_{ON}$  pulse on the high side switch (HSD). After this, the LSD is switched on and current falls at a rate  $V_{OUT}/L$ . The controller remains in HLL mode while the inductor falling current is detected to cross approximately -50 mA. When the LSD (or  $t_{OFF}$ ) time reaches its

# MIC23153

minimum and the inductor falling current is no longer able to reach this –50 mA threshold, the part is in CCM mode and switching at a virtually constant frequency.

Once in CCM mode, the  $t_{OFF}$  time will not vary. Therefore, it is important to note that if L is large enough, the HLL transition level will not be triggered.

That inductor is:

## EQUATION 5-2:

$$L_{MAX} = \frac{V_{OUT} \times 135ns}{2 \times 50mA}$$

## 5.4 Compensation

The MIC23153 is designed to be stable with a 0.47  $\mu$ H to 2.2  $\mu$ H inductor with a 4.7  $\mu$ F ceramic (X5R) output capacitor.

## 5.5 Duty Cycle

The typical maximum duty cycle of the MIC23153 is 80%.

## 5.6 Efficiency Considerations

Efficiency is defined as the amount of useful output power, divided by the amount of power supplied.

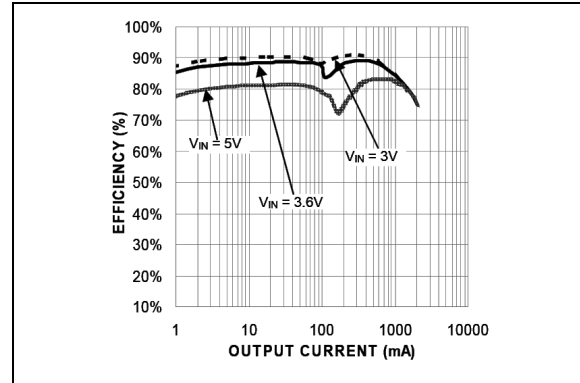
## EQUATION 5-3:

$$\eta = \left( \frac{V_{OUT} \times I_{OUT}}{V_{IN} \times I_{IN}} \right) \times 100$$

Maintaining high efficiency serves two purposes. It reduces power dissipation in the power supply, reducing the need for heat sinks and thermal design considerations and it reduces consumption of current for battery powered applications. Reduced current draw from a battery increases the devices operating time which is critical in hand held devices.

There are two types of losses in switching converters; DC losses and switching losses. DC losses are simply the power dissipation of  $I^2R$ . Power is dissipated in the high-side switch during the on cycle. Power loss is equal to the high-side MOSFET  $R_{DS(ON)}$  multiplied by the switch current squared. During the off cycle, the low-side N-channel MOSFET conducts, also dissipating power. Device operating current also reduces efficiency. The product of the quiescent (operating) current and the supply voltage represents

another DC loss. The current required driving the gates on and off at a constant 4 MHz frequency and the switching transitions make up the switching losses.



**FIGURE 5-2:** Efficiency Under Load  
 $V_{OUT} = 1.8V @ 25^{\circ}C$ .

Figure 5-2 shows an efficiency curve. From no load to 100 mA, efficiency losses are dominated by quiescent current losses, gate drive and transition losses. By using the HyperLight Load<sup>®</sup> mode, the MIC23153 is able to maintain high efficiency at low output currents.

Over 100 mA, efficiency loss is dominated by MOSFET  $R_{DS(ON)}$  and inductor losses. Higher input supply voltages will increase the gate to source threshold on the internal MOSFETs, thereby reducing the internal  $R_{DS(ON)}$ . This improves efficiency by reducing DC losses in the device. All but the inductor losses are inherent to the device. In which case, inductor selection becomes increasingly critical in efficiency calculations. As the inductors are reduced in size, the DC resistance (DCR) can become quite significant.

The DCR losses can be calculated by using [Equation 5-4](#):

## EQUATION 5-4:

$$P_{DCR} = I_{OUT}^2 \times DCR$$

From that, the loss in efficiency due to inductor resistance can be calculated by using [Equation 5-5](#):

## EQUATION 5-5:

$$EfficiencyLoss = \left[ 1 - \left( \frac{V_{OUT} \times I_{OUT}}{V_{OUT} \times I_{OUT} + P_{DCR}} \right) \right] \times 100$$



Efficiency loss due to DCR is minimal at light loads and gains significance as the load is increased. Inductor selection becomes a trade-off between efficiency and size in this case.

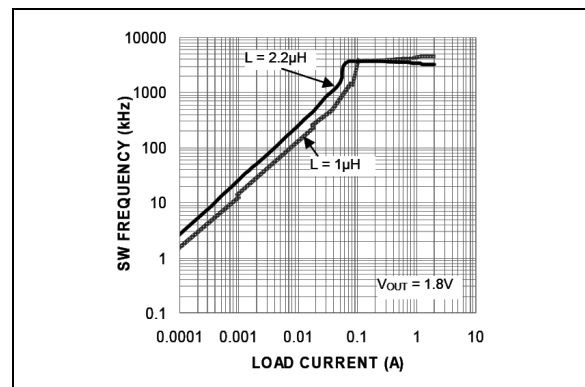
## 5.7 HyperLight Load<sup>®</sup> Mode

The MIC23153 uses a minimum on and off time proprietary control loop. When the output voltage falls below the regulation threshold, the error comparator begins a switching cycle that turns the PMOS on and keeps it on for the duration of the minimum on-time. When the output voltage is over the regulation threshold, the error comparator turns the PMOS off for a minimum off-time. The NMOS acts as an ideal rectifier that conducts when the PMOS is off. Using a NMOS switch instead of a diode allows for lower voltage drop across the switching device when it is on. The asynchronous switching combination between the PMOS and the NMOS allows the control loop to work in discontinuous mode for light load operations. In discontinuous mode, MIC23153 works in pulse frequency modulation (PFM) to regulate the output. As the output current increases, the switching frequency increases. This improves the efficiency of the MIC23153 during light load currents. As the load current increases, the MIC23153 goes into continuous conduction mode (CCM) at a constant frequency of 4 MHz. The equation to calculate the load when the MIC23153 goes into continuous conduction mode may be approximated by the following [Equation 5-6](#):

### EQUATION 5-6:

$$I_{LOAD} = \left( \frac{(V_{IN} - V_{OUT}) \times D}{2 \times L \times f} \right)$$

As shown in the above equation, the load at which MIC23153 transitions from HyperLight Load<sup>®</sup> mode to PWM mode is a function of the input voltage ( $V_{IN}$ ), output voltage ( $V_{OUT}$ ), duty cycle ( $D$ ), inductance ( $L$ ) and frequency ( $f$ ). As shown in [Figure 5-3](#), as the output current increases, the switching frequency also increases until the MIC23153 goes from HyperLight Load<sup>®</sup> mode to PWM mode at approximately 120 mA. The MIC23153 will switch at a relatively constant frequency around 4 MHz once the output current is over 120 mA.



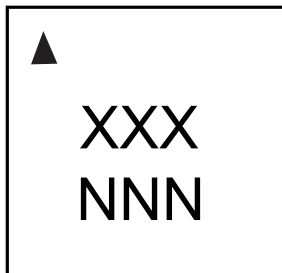
**FIGURE 5-3:** Switching Frequency vs. Output Current.

# MIC23153

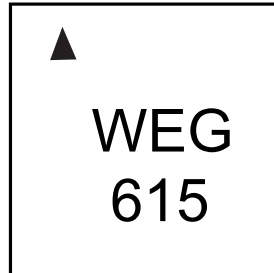
## 6.0 PACKAGING INFORMATION

### 6.1 Package Marking Information

#### 10-Lead TDFN\*



#### Example



Part Number	Code
MIC23153-GYMT-TR	WEG
MIC23153YMT-TR	WEA

**Note:** The content of this table applies to 10-Lead TDFN.

<b>Legend:</b>	XX...X	Product code or customer-specific information
	Y	Year code (last digit of calendar year)
	YY	Year code (last 2 digits of calendar year)
	WW	Week code (week of January 1 is week '01')
	NNN	Alphanumeric traceability code
	(e3)	Pb-free JEDEC® designator for Matte Tin (Sn)
	*	This package is Pb-free. The Pb-free JEDEC designator (e3) can be found on the outer packaging for this package.
	•, ▲, ▼	Pin one index is identified by a dot, delta up, or delta down (triangle mark).
<b>Note:</b>	In the event the full Microchip part number cannot be marked on one line, it will be carried over to the next line, thus limiting the number of available characters for customer-specific information. Package may or may not include the corporate logo.	
	Underbar (¯) and/or Overbar (˘) symbol may not be to scale.	

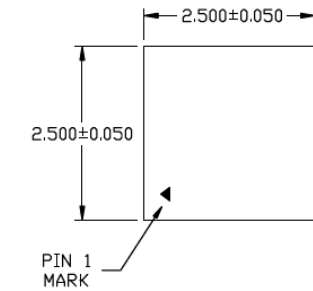
**Note:** If the full seven-character YYWWNNN code cannot fit on the package, the following truncated codes are used based on the available marking space:  
6 Characters = YWWNNN; 5 Characters = WWNNN; 4 Characters = WNNN; 3 Characters = NNN;  
2 Characters = NN; 1 Character = N

## 10-Lead TDFN 2.5 mm x 2.5 mm Package Outline and Recommended Land Pattern

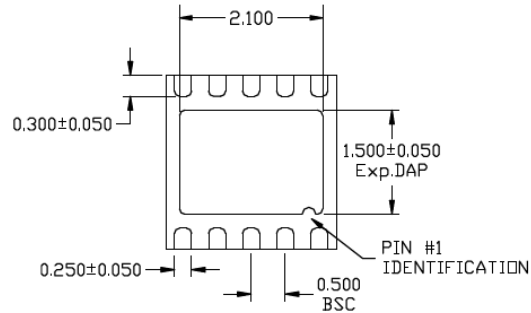
### TITLE

10 LEAD TDFN 2.5x2.5mm PACKAGE OUTLINE & RECOMMENDED LAND PATTERN

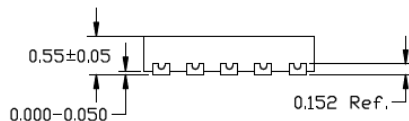
<b>DRAWING #</b>	TDFN2525-10LD-PL-1	<b>UNIT</b>	MM
<b>Lead Frame</b>	Copper	<b>Lead Finish</b>	Matte Tin



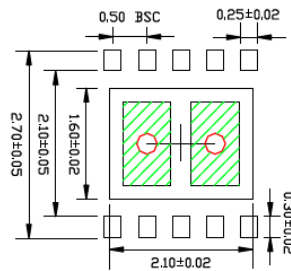
**TOP VIEW**  
NOTE: 1, 2, 3



**BOTTOM VIEW**  
NOTE: 1, 2



**SIDE VIEW**  
NOTE: 1, 2



**RECOMMENDED LAND PATTERN**  
NOTE: 4

#### NOTE:

1. MAX PACKAGE WARPAGE IS 0.05MM
2. MAX ALLOWABLE BURR IS 0.076MM IN ALL DIRECTIONS
3. PIN #1 IS ON TOP WILL BE LASER MARKED
4. GREEN RECTANGLES (SHADED AREA) INDICATE STENCIL OPENING ON EXPOSED AREA. SIZE IS 0.6X0.9MM, SPACING IS 0.3MM.
5. RED CIRCLES REPRESENT THERMAL VIAS & SHOULD BE CONNECTED TO GND FOR MAX PERFORMANCE. 0.30 - 0.35 MM RECOMMENDED DIAMETER, 1.00 MM PITCH

Note: For the most current package drawings, please see the Microchip Packaging Specification located at <http://www.microchip.com/packaging>.

# MIC23153

---

---

NOTES:

## APPENDIX A: REVISION HISTORY

### Revision A (February 2021)

- Converted Micrel document MIC23153 to Microchip data sheet DS20006489B.
- Minor text changes throughout.

### Revision B (April 2022)

- Updated **Section “Product Identification System”**.
- Updated **Section 6.0 “Packaging Information”**.
- Corrected package outline image to **“10-Lead TDFN 2.5 mm x 2.5 mm Package Outline and Recommended Land Pattern”** from a 10-Lead TDFN image.
- Minor format changes throughout.

# MIC23153

---

---

NOTES:

## PRODUCT IDENTIFICATION SYSTEM

To order or obtain information, e.g., on pricing or delivery, contact your local Microchip representative or sales office.

<u>PART NO.</u>	<u>-X</u>	<u>X</u>	<u>XX</u>	<u>-XX</u>
Device	Output Voltage	Junction Temperature Range	Package Option	Media Type
<b>Device:</b>	MIC23153: 4 MHz 2A PWM Buck Regulator with HyperLight Load® and Power Good			
<b>Output Voltage:</b>	G = 1.8V Blank = Adjustable			
<b>Junction Temperature Range:</b>	Y = -40°C to +125°C			
<b>Package:</b>	MT = 10-Lead 2.5 mm x 2.5 mm x 0.6 mm TDFN			
<b>Media Type:</b>	TR = 5000/Reel			
<b>Note:</b> Other output voltage options are available. Contact Factory for details.				

### Examples:

- a) MIC23153-GYMT-TR: 4 MHz 2A PWM Buck Regulator with HyperLight Load® and Power Good, 1.8V Fixed Output Voltage, -40°C to +125°C Junction Temperature Range, Pb-Free, RoHS Compliant, 10-Lead TDFN Package, 5000/Reel
- b) MIC23153YMT-TR: 4 MHz 2A PWM Buck Regulator with HyperLight Load® and Power Good, Adjustable Output Voltage, -40°C to +125°C Junction Temperature Range, Pb-Free, RoHS Compliant, 10-Lead TDFN Package, 5000/Reel

**Note 1:** Tape and Reel identifier only appears in the catalog part number description. This identifier is used for ordering purposes and is not printed on the device package. Check with your Microchip Sales Office for package availability with the Tape and Reel option.

# MIC23153

---

---

NOTES:



---

---

**Note the following details of the code protection feature on Microchip products:**

- Microchip products meet the specifications contained in their particular Microchip Data Sheet.
- Microchip believes that its family of products is secure when used in the intended manner, within operating specifications, and under normal conditions.
- Microchip values and aggressively protects its intellectual property rights. Attempts to breach the code protection features of Microchip product is strictly prohibited and may violate the Digital Millennium Copyright Act.
- Neither Microchip nor any other semiconductor manufacturer can guarantee the security of its code. Code protection does not mean that we are guaranteeing the product is “unbreakable”. Code protection is constantly evolving. Microchip is committed to continuously improving the code protection features of our products.

---

This publication and the information herein may be used only with Microchip products, including to design, test, and integrate Microchip products with your application. Use of this information in any other manner violates these terms. Information regarding device applications is provided only for your convenience and may be superseded by updates. It is your responsibility to ensure that your application meets with your specifications. Contact your local Microchip sales office for additional support or, obtain additional support at <https://www.microchip.com/en-us/support/design-help/client-support-services>.

THIS INFORMATION IS PROVIDED BY MICROCHIP "AS IS". MICROCHIP MAKES NO REPRESENTATIONS OR WARRANTIES OF ANY KIND WHETHER EXPRESS OR IMPLIED, WRITTEN OR ORAL, STATUTORY OR OTHERWISE, RELATED TO THE INFORMATION INCLUDING BUT NOT LIMITED TO ANY IMPLIED WARRANTIES OF NON-INFRINGEMENT, MERCHANTABILITY, AND FITNESS FOR A PARTICULAR PURPOSE, OR WARRANTIES RELATED TO ITS CONDITION, QUALITY, OR PERFORMANCE.

IN NO EVENT WILL MICROCHIP BE LIABLE FOR ANY INDIRECT, SPECIAL, PUNITIVE, INCIDENTAL, OR CONSEQUENTIAL LOSS, DAMAGE, COST, OR EXPENSE OF ANY KIND WHATSOEVER RELATED TO THE INFORMATION OR ITS USE, HOWEVER CAUSED, EVEN IF MICROCHIP HAS BEEN ADVISED OF THE POSSIBILITY OR THE DAMAGES ARE FORESEEABLE. TO THE FULLEST EXTENT ALLOWED BY LAW, MICROCHIP'S TOTAL LIABILITY ON ALL CLAIMS IN ANY WAY RELATED TO THE INFORMATION OR ITS USE WILL NOT EXCEED THE AMOUNT OF FEES, IF ANY, THAT YOU HAVE PAID DIRECTLY TO MICROCHIP FOR THE INFORMATION.

Use of Microchip devices in life support and/or safety applications is entirely at the buyer's risk, and the buyer agrees to defend, indemnify and hold harmless Microchip from any and all damages, claims, suits, or expenses resulting from such use. No licenses are conveyed, implicitly or otherwise, under any Microchip intellectual property rights unless otherwise stated.

For information regarding Microchip's Quality Management Systems, please visit [www.microchip.com/quality](http://www.microchip.com/quality).

**Trademarks**

The Microchip name and logo, the Microchip logo, Adaptec, AnyRate, AVR, AVR logo, AVR Freaks, BesTime, BitCloud, CryptoMemory, CryptoRF, dsPIC, flexPWR, HELDO, IGLOO, JukeBlox, KeeLoq, Klear, LANCheck, LinkMD, maXStylus, maXTouch, MediaLB, megaAVR, Microsemi, Microsemi logo, MOST, MOST logo, MPLAB, OptoLyzzer, PIC, picoPower, PICSTART, PIC32 logo, PolarFire, Prochip Designer, QTouch, SAM-BA, SenGenuity, SpyNIC, SST, SST Logo, SuperFlash, Symmetricom, SyncServer, Tachyon, TimeSource, tinyAVR, UNI/O, Vectron, and XMEGA are registered trademarks of Microchip Technology Incorporated in the U.S.A. and other countries.

AgileSwitch, APT, ClockWorks, The Embedded Control Solutions Company, EtherSynch, Flashtec, Hyper Speed Control, HyperLight Load, IntelliMOS, Libero, motorBench, mTouch, Powermite 3, Precision Edge, ProASIC, ProASIC Plus, ProASIC Plus logo, QuietWire, SmartFusion, SyncWorld, Temux, TimeCesium, TimeHub, TimePictra, TimeProvider, TrueTime, WinPath, and ZL are registered trademarks of Microchip Technology Incorporated in the U.S.A.

Adjacent Key Suppression, AKS, Analog-for-the-Digital Age, Any Capacitor, AnyIn, AnyOut, Augmented Switching, BlueSky, BodyCom, CodeGuard, CryptoAuthentication, CryptoAutomotive, CryptoCompanion, CryptoController, dsPICDEM, dsPICDEM.net, Dynamic Average Matching, DAM, ECAN, Espresso T1S, EtherGREEN, GridTime, IdealBridge, In-Circuit Serial Programming, ICSP, INICnet, Intelligent Paralleling, Inter-Chip Connectivity, JitterBlocker, Knob-on-Display, maxCrypto, maxView, memBrain, Mindi, MiWi, MPASM, MPF, MPLAB Certified logo, MPLIB, MPLINK, MultiTRAK, NetDetach, NVM Express, NVMe, Omniscient Code Generation, PICDEM, PICDEM.net, PICkit, PICtail, PowerSmart, PureSilicon, QMatrix, REAL ICE, Ripple Blocker, RTAX, RTG4, SAM-ICE, Serial Quad I/O, simpleMAP, SimpliPHY, SmartBuffer, SmartHLS, SMART-I.S., storClad, SQI, SuperSwitcher, SuperSwitcher II, Switchtec, SynchroPHY, Total Endurance, TSHARC, USBCheck, VariSense, VectorBlox, VeriPHY, ViewSpan, WiperLock, XpressConnect, and ZENA are trademarks of Microchip Technology Incorporated in the U.S.A. and other countries.

SQTP is a service mark of Microchip Technology Incorporated in the U.S.A.

The Adaptec logo, Frequency on Demand, Silicon Storage Technology, Symmcom, and Trusted Time are registered trademarks of Microchip Technology Inc. in other countries.

GestIC is a registered trademark of Microchip Technology Germany II GmbH & Co. KG, a subsidiary of Microchip Technology Inc., in other countries.

All other trademarks mentioned herein are property of their respective companies.

© 2021 - 2022, Microchip Technology Incorporated and its subsidiaries.

All Rights Reserved.

ISBN: 978-1-6683-0342-9



# MICROCHIP

## Worldwide Sales and Service

### 4AMERICAS

**Corporate Office**  
2355 West Chandler Blvd.  
Chandler, AZ 85224-6199  
Tel: 480-792-7200  
Fax: 480-792-7277  
Technical Support:  
<http://www.microchip.com/support>  
Web Address:  
[www.microchip.com](http://www.microchip.com)

**Atlanta**  
Duluth, GA  
Tel: 678-957-9614  
Fax: 678-957-1455

**Austin, TX**  
Tel: 512-257-3370

**Boston**  
Westborough, MA  
Tel: 774-760-0087  
Fax: 774-760-0088

**Chicago**  
Itasca, IL  
Tel: 630-285-0071  
Fax: 630-285-0075

**Dallas**  
Addison, TX  
Tel: 972-818-7423  
Fax: 972-818-2924

**Detroit**  
Novi, MI  
Tel: 248-848-4000

**Houston, TX**  
Tel: 281-894-5983

**Indianapolis**  
Noblesville, IN  
Tel: 317-773-8323  
Fax: 317-773-5453  
Tel: 317-536-2380

**Los Angeles**  
Mission Viejo, CA  
Tel: 949-462-9523  
Fax: 949-462-9608  
Tel: 951-273-7800

**Raleigh, NC**  
Tel: 919-844-7510

**New York, NY**  
Tel: 631-435-6000

**San Jose, CA**  
Tel: 408-735-9110  
Tel: 408-436-4270

**Canada - Toronto**  
Tel: 905-695-1980  
Fax: 905-695-2078

### ASIA/PACIFIC

**Australia - Sydney**  
Tel: 61-2-9868-6733

**China - Beijing**  
Tel: 86-10-8569-7000

**China - Chengdu**  
Tel: 86-28-8665-5511

**China - Chongqing**  
Tel: 86-23-8980-9588

**China - Dongguan**  
Tel: 86-769-8702-9880

**China - Guangzhou**  
Tel: 86-20-8755-8029

**China - Hangzhou**  
Tel: 86-571-8792-8115

**China - Hong Kong SAR**  
Tel: 852-2943-5100

**China - Nanjing**  
Tel: 86-25-8473-2460

**China - Qingdao**  
Tel: 86-532-8502-7355

**China - Shanghai**  
Tel: 86-21-3326-8000

**China - Shenyang**  
Tel: 86-24-2334-2829

**China - Shenzhen**  
Tel: 86-755-8864-2200

**China - Suzhou**  
Tel: 86-186-6233-1526

**China - Wuhan**  
Tel: 86-27-5980-5300

**China - Xian**  
Tel: 86-29-8833-7252

**China - Xiamen**  
Tel: 86-592-2388138

**China - Zhuhai**  
Tel: 86-756-3210040

### ASIA/PACIFIC

**India - Bangalore**  
Tel: 91-80-3090-4444

**India - New Delhi**  
Tel: 91-11-4160-8631

**India - Pune**  
Tel: 91-20-4121-0141

**Japan - Osaka**  
Tel: 81-6-6152-7160

**Japan - Tokyo**  
Tel: 81-3-6880-3770

**Korea - Daegu**  
Tel: 82-53-744-4301

**Korea - Seoul**  
Tel: 82-2-554-7200

**Malaysia - Kuala Lumpur**  
Tel: 60-3-7651-7906

**Malaysia - Penang**  
Tel: 60-4-227-8870

**Philippines - Manila**  
Tel: 63-2-634-9065

**Singapore**  
Tel: 65-6334-8870

**Taiwan - Hsin Chu**  
Tel: 886-3-577-8366

**Taiwan - Kaohsiung**  
Tel: 886-7-213-7830

**Taiwan - Taipei**  
Tel: 886-2-2508-8600

**Thailand - Bangkok**  
Tel: 66-2-694-1351

**Vietnam - Ho Chi Minh**  
Tel: 84-28-5448-2100

### EUROPE

**Austria - Wels**  
Tel: 43-7242-2244-39  
Fax: 43-7242-2244-393

**Denmark - Copenhagen**  
Tel: 45-4485-5910  
Fax: 45-4485-2829

**Finland - Espoo**  
Tel: 358-9-4520-820

**France - Paris**  
Tel: 33-1-69-53-63-20  
Fax: 33-1-69-30-90-79

**Germany - Garching**  
Tel: 49-8931-9700

**Germany - Haan**  
Tel: 49-2129-3766400

**Germany - Heilbronn**  
Tel: 49-7131-72400

**Germany - Karlsruhe**  
Tel: 49-721-625370

**Germany - Munich**  
Tel: 49-89-627-144-0  
Fax: 49-89-627-144-44

**Germany - Rosenheim**  
Tel: 49-8031-354-560

**Israel - Ra'anana**  
Tel: 972-9-744-7705

**Italy - Milan**  
Tel: 39-0331-742611  
Fax: 39-0331-466781

**Italy - Padova**  
Tel: 39-049-7625286

**Netherlands - Drunen**  
Tel: 31-416-690399  
Fax: 31-416-690340

**Norway - Trondheim**  
Tel: 47-7288-4388

**Poland - Warsaw**  
Tel: 48-22-3325737

**Romania - Bucharest**  
Tel: 40-21-407-87-50

**Spain - Madrid**  
Tel: 34-91-708-08-90  
Fax: 34-91-708-08-91

**Sweden - Gothenberg**  
Tel: 46-31-704-60-40

**Sweden - Stockholm**  
Tel: 46-8-5090-4654

**UK - Wokingham**  
Tel: 44-118-921-5800  
Fax: 44-118-921-5820