

LMBT4403LT1G

S-LMBT4403LT1G

General Purpose Transistors PNP Silicon

1. FEATURES

- We declare that the material of product compliance with RoHS requirements and Halogen Free.
- S- prefix for automotive and other applications requiring unique site and control change requirements; AEC-Q101 qualified and PPAP capable.

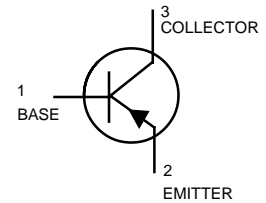
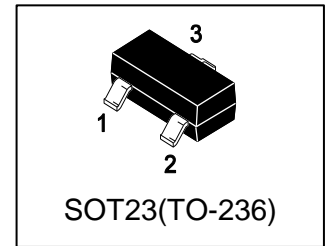

2. DEVICE MARKING AND ORDERING INFORMATION

Device	Marking	Shipping
LMBT4403LT1G	2T	3000/Tape&Reel
LMBT4403LT3G	2T	10000/Tape&Reel

3. MAXIMUM RATINGS(Ta = 25°C)

Parameter	Symbol	Limits	Unit
Collector–Emitter Voltage	V _{CEO}	-40	V
Collector–Base Voltage	V _{CBO}	-40	V
Emitter–Base Voltage	V _{EBO}	-5	V
Collector Current — Continuous	I _C	-600	mA

4. THERMAL CHARACTERISTICS

Parameter	Symbol	Limits	Unit
Total Device Dissipation, FR-5 Board (Note 1) @ TA = 25°C Derate above 25°C	PD	225 1.8	mW mW/°C
Thermal Resistance, Junction–to–Ambient(Note 1)	R _{θJA}	556	°C/W
Total Device Dissipation, Alumina Substrate(Note 2) @ TA = 25°C Derate above 25°C	PD	300 2.4	mW mW/°C
Thermal Resistance, Junction–to–Ambient(Note 2)	R _{θJA}	417	°C/W
Junction and Storage temperature	T _J , T _{stg}	-55~+150	°C

1. FR-5 = 1.0×0.75×0.062 in.

2. Alumina = 0.4 x 0.3 x 0.024 in. 99.5% alumina.

5. ELECTRICAL CHARACTERISTICS (Ta= 25°C)
OFF CHARACTERISTICS

Characteristic	Symbol	Min.	Typ.	Max.	Unit
Collector–Emitter Breakdown Voltage (IC = -1.0 mA, IB = 0)	VBR(CEO)	-40	-	-	V
Collector–Base Breakdown Voltage (IC = -0.1 mA, IE = 0)	VBR(CBO)	-40	-	-	V
Emitter–Base Breakdown Voltage (IE = -0.1 mA, IC = 0)	VBR(EBO)	-5	-	-	V
Base Cutoff Current (VCE = -35 V, VEB = -0.4V)	IBEV	-	-	-0.1	μA
Collector Cutoff Current (VCE = -35 V, VEB = -0.4V)	ICEX	-	-	-0.1	μA
Collector-Emitter cutoff Current (IB=0, VCE=-30V)	ICEO	-	-	-10	μA
Collector Cutoff Current (VCB = -60 V, IE = 0)	ICBO	-	-	-100	nA
Emitter Cut-off Current (VEB = -6V, IC = 0)	IEBO	-	-	-100	nA

ON CHARACTERISTICS

DC Current Gain (IC = -0.1 mA, VCE = -1.0 V) (IC = -1.0 mA, VCE = -1.0 V) (IC = -10 mA, VCE = -1.0 V) (IC = -150 mA, VCE = -2.0 V) (IC = -500 mA, VCE = -2.0 V)	hFE	30 60 100 100 20	- - - - -	- - - 300 -	
Collector–Emitter Saturation Voltage (IC = -150 mA, IB = -15 mA) (IC = -500 mA, IB = -50 mA)	VCE(sat)	- -	- -	-0.4 -0.75	V
Base–Emitter Saturation Voltage (IC = -150 mA, IB = -15 mA) (IC = -500 mA, IB = -50 mA)	VBE(sat)	-0.75 -	- -	-0.95 -1.3	V

SMALL–SIGNAL CHARACTERISTICS

Current–Gain — Bandwidth Product (IC = -20mA, VCE = -10 V, f = 100 MHz)	fT	200	-	-	MHz
Collector–Base Capacitance (VCB = -10 V, IE = 0, f = 1.0 MHz)	Ccb	-	-	8.5	pF
Emitter–Base Capacitance (VBE = -0.5 V, IC = 0, f = 1.0 MHz)	Ceb	-	-	30	pF
Small–Signal Current Gain (VCE = -10 V, IC = -1.0 mA, f = 1.0 kHz)	hfe	60	-	500	-

SWITCHING CHARACTERISTICS

Delay Time	(VCC=-30V, VEB=-2.0V , IC=-150mA, IB1=-15mA)	td	-	-	15	ns
Rise Time		tr	-	-	20	
Storage Time	(VCC = -30 V, IC=-150 mA, IB1=IB2=-15 mA)	ts	-	-	225	
Fall Time		tf	-	-	30	

3. Pulse Test: Pulse Width ≤ 300 μs, Duty Cycle ≤ 2.0%.

6.ELECTRICAL CHARACTERISTICS CURVES

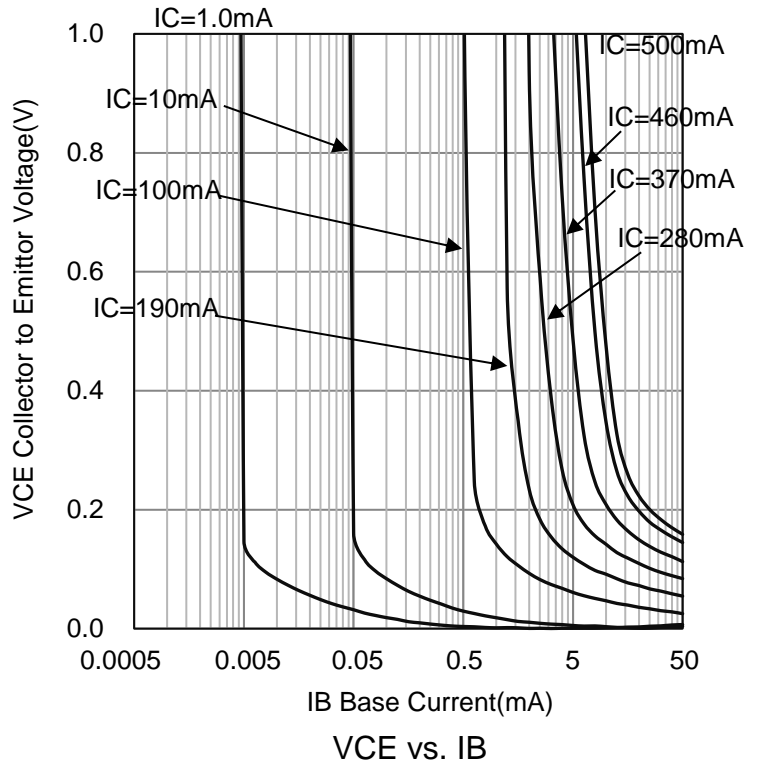
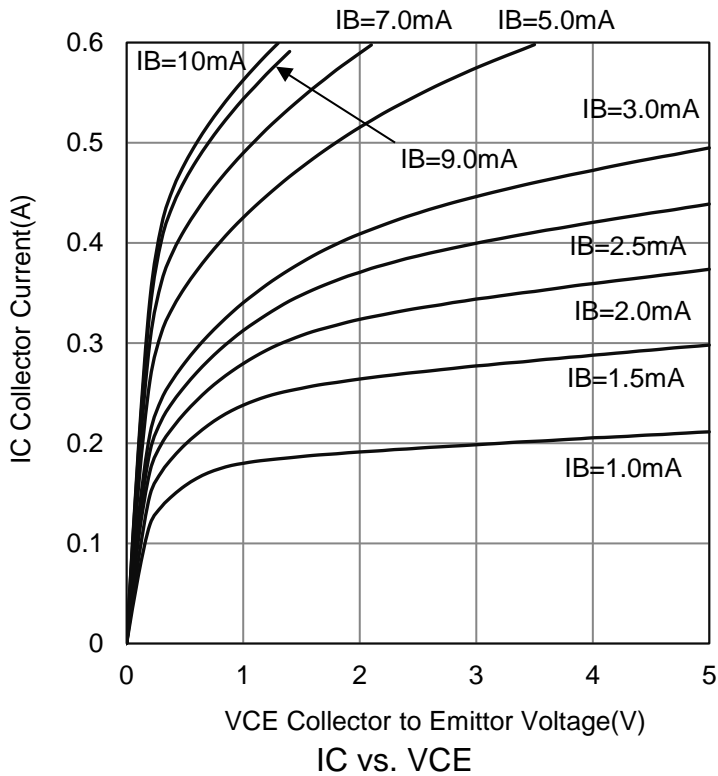
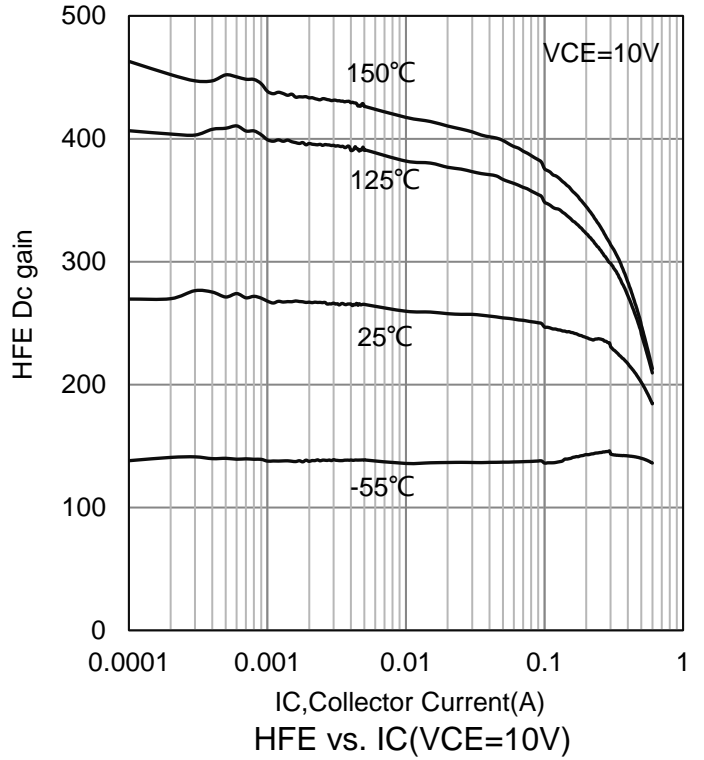
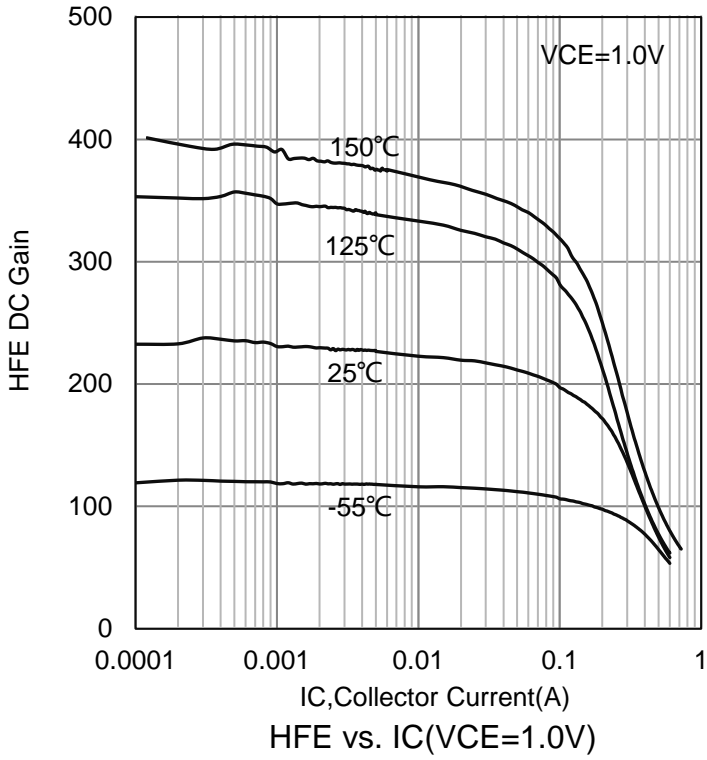

6.ELECTRICAL CHARACTERISTICS CURVES(Con.)

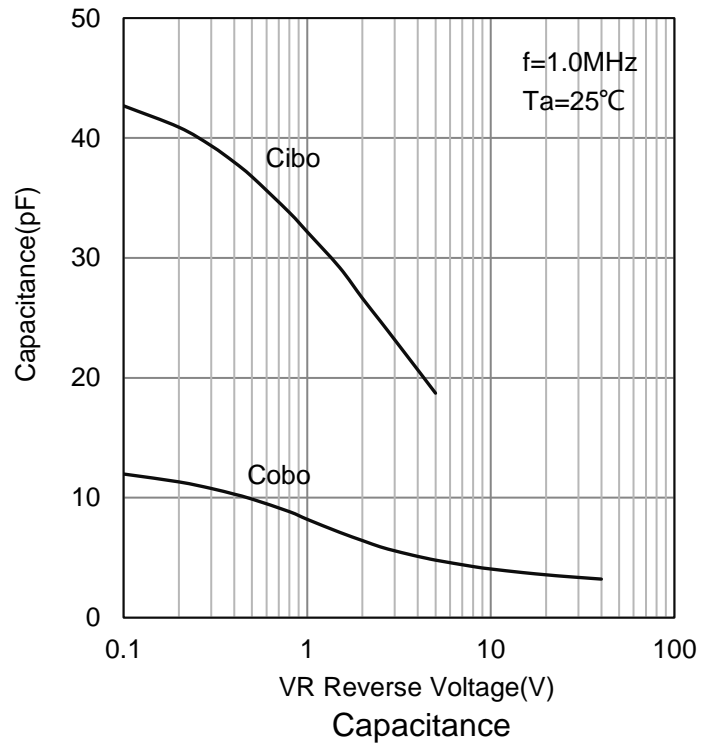
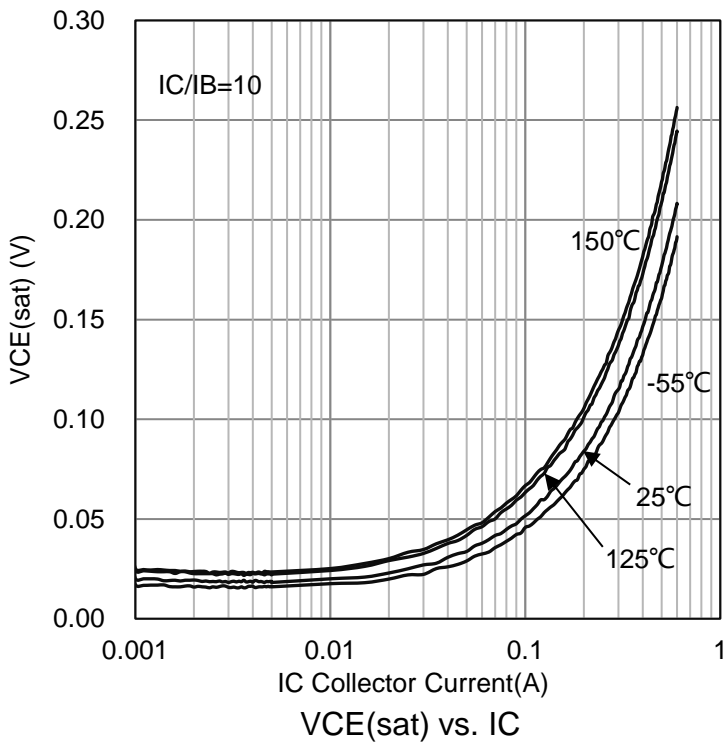
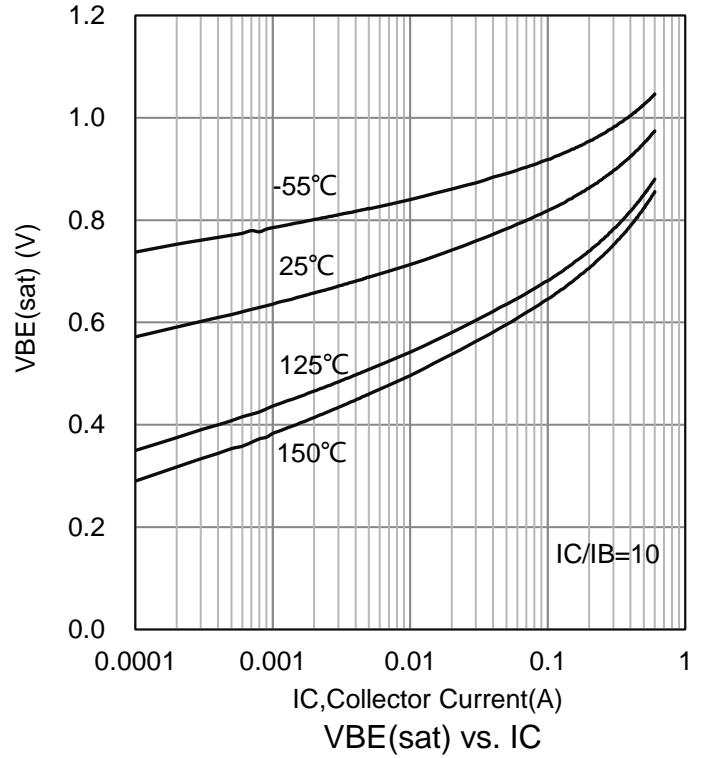
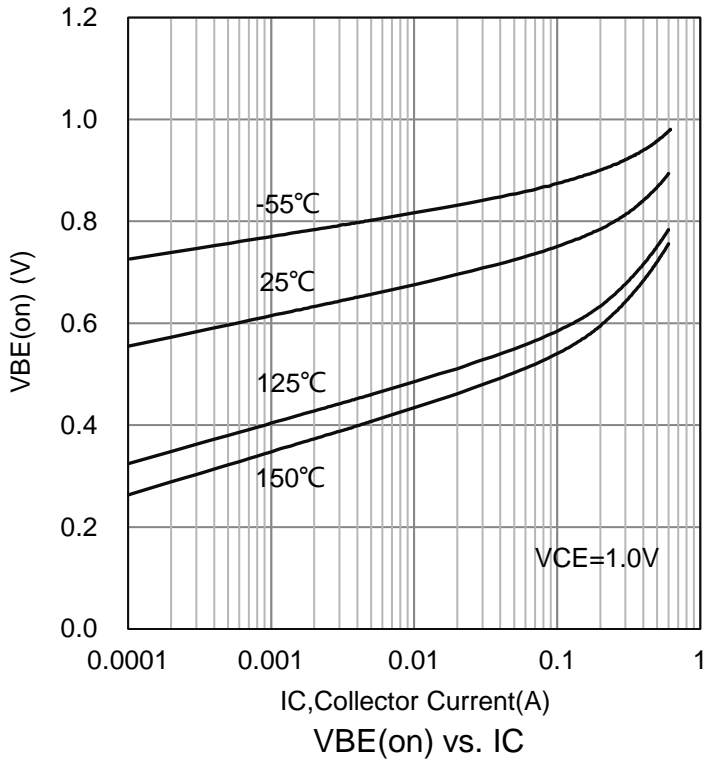

7. OUTLINE AND DIMENSIONS

Notes:

1. DIMENSIONING AND TOLERANCING PER ANSI Y14.5M, 1982.
2. CONTROLLING DIMENSION: MILLIMETERS.
3. MAXIMUM LEAD THICKNESS INCLUDES LEAD FINISH. MINIMUM LEAD THICKNESS IS THE MINIMUM THICKNESS OF BASE MATERIAL.
4. DIMENSIONS D AND E DO NOT INCLUDE MOLD FLASH, PROTRUSIONS OR GATE BURRS.

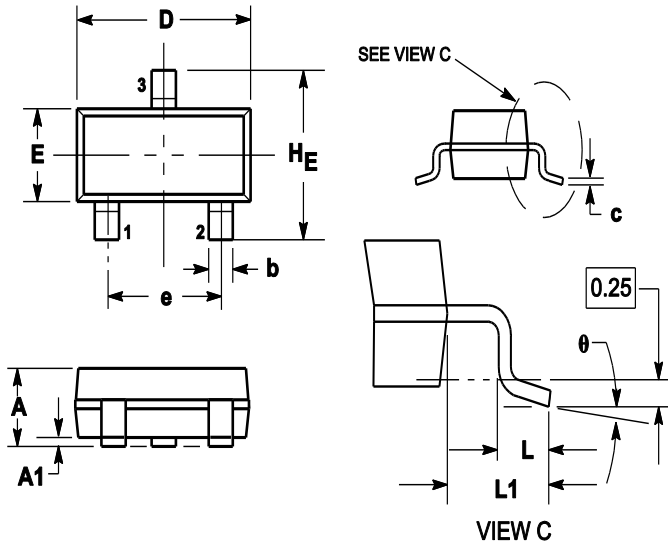

DIM	MILLIMETERS			INCHES		
	MIN	NOM	MAX	MIN	NOM	MAX
A	0.89	1	1.11	0.035	0.04	0.044
A1	0.01	0.06	0.1	0.001	0.002	0.004
b	0.37	0.44	0.5	0.015	0.018	0.02
c	0.09	0.13	0.18	0.003	0.005	0.007
D	2.80	2.9	3.04	0.11	0.114	0.12
E	1.20	1.3	1.4	0.047	0.051	0.055
e	1.78	1.9	2.04	0.07	0.075	0.081
L	0.10	0.2	0.3	0.004	0.008	0.012
L1	0.35	0.54	0.69	0.014	0.021	0.029
HE	2.10	2.4	2.64	0.083	0.094	0.104
θ	0°	---	10°	0°	---	10°

8. SOLDERING FOOTPRINT

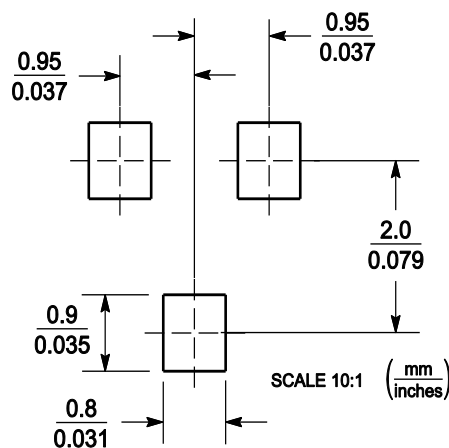

DISCLAIMER

- Curve guarantee in the specification. The curve of test items with electric parameter is used as quality guarantee. The curve of test items without electric parameter is used as reference only.
- Before you use our Products for new Project, you are requested to carefully read this document and fully understand its contents. LRC shall not be in any way responsible or liable for failure, malfunction or accident arising from the use of any LRC's Products against warning, caution or note contained in this document.
- All information contained in this document is current as of the issuing date and subject to change without any prior notice. Before purchasing or using LRC's Products, please confirm the latest information with a LRC sales representative.